



SCDF

The Life Saving Force



CODE OF PRACTICE FOR FIRE PRECAUTIONS IN BUILDINGS 2018

SINGAPORE CIVIL DEFENCE FORCE



Code of Practice for Fire Precautions in Buildings 2018

All rights reserved. No part of this publication may be reproduced, stored in a retrieval system, or transmitted in any form or by means, electronic, mechanical, photocopying, recording or otherwise, without the prior permission of the Singapore Civil Defence Force.

1st edition : 1974

2nd edition : 1982

3rd edition : 1991

4th edition : 1997

5th edition : 2002

6th edition : 2007

7th edition : 2013

8th edition : 2018

Published by :
Singapore Civil Defence Force
91 Ubi Avenue 4
Singapore 408827



SCDF
The Life Saving Force

<http://www.scdf.gov.sg>

FOREWORD

The Fire Code is a living document periodically reviewed by the SCDF to ensure that fire safety standards keep pace with Singapore's evolving urban landscape and national development. By taking into account the knowledge gleaned from valuable feedback received during consultation sessions with Qualified Persons, dialogues and meetings with other industry professionals, the SCDF ensures that the Fire Code remains relevant to the practices of the building industry and effective in its purpose.

The latest 8th edition of the Fire Code is the result of a multi-disciplinary, multi-professional public-private collaborative endeavour. It adopts an evidence-based and quantitative approach involving literature research, comparative studies, fire tests and the conduct of fire and evacuation modelling. The objective is to make the Code requirements sharper and less onerous through quantitative assessment to manage the risks. Led by the SCDF, the Fire Code Review Committee comprises esteemed representatives from professional bodies, academia and statutory boards. The Committee has contributed immensely and I would like to place on record our appreciation for their assiduous efforts.

In the process of review, we were guided by the need for the Fire Code to be more user-friendly and organised. For instance, over the years, a growing number of appendices were added to the Fire Code in response to new systems, fire safety products and developments being introduced into the building industry. This made referencing complicated as related fire safety requirements were mentioned in both the main sections and appendices of the Fire Code. One of the key changes is the incorporation of the annexes and appendices into the main sections of the Fire Code to avoid confusion on the significance of the annexes and appendices vis-à-vis the main sections of the Code. And to enhance user experience, the 8th edition has been digitised with interactive features that facilitate speedy search and cross-referencing. All users will now have access to web-based information they need anytime, anywhere via the SCDF website.

The editorial team also improved descriptions in the Fire Code to meet the requirements of a variety of users including non-technically trained users. Other aspects of the review include addressing common consultation and waiver issues with a view to mainstream them, as well as permitting the use of new building products, materials, systems and technologies. In doing so, the Fire Code is refreshed to ensure currency and relevance.

Over the years, SCDF and our stakeholders have work closely to maintain a high standard of fire safety in Singapore. We must continue to progress and surpass expectations on public safety. The latest Code is both progressive and pro-enterprise in design with fire safety at the centre.

SCDF is always open to feedback and suggestions on fire safety requirements and I look forward to our stakeholders' continued support and partnership with the SCDF.

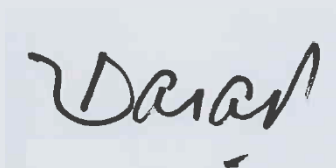
A handwritten signature in black ink, appearing to read 'Eric Yap', is positioned above the printed name and title.

ERIC YAP
COMMISSIONER
SINGAPORE CIVIL DEFENCE FORCE

August 2018

CODE OF PRACTICE FOR FIRE PRECAUTIONS IN BUILDINGS REVIEW COMMITTEE

The Code of Practice for Fire Precautions in Buildings Review Committee comprises the following members:

Advisor:	Commissioner Eric Yap	Singapore Civil Defence Force
Chairman:	SAC Christopher Tan	Singapore Civil Defence Force
Secretary:	Mr Tan Yi Yang	Singapore Civil Defence Force
Editor:	Mr Tan Eu Seng, Randy	Singapore Civil Defence Force
Members:	Er Teo Yann	..	Association of Consulting Engineers, Singapore
	Er Vincent Han	..	Association of Consulting Engineers, Singapore
	Er (Dr) Tran Chi Trung	Building & Construction Authority
	Ar Tan Lily	Housing & Development Board
	Ar Jansen Foo Chek Han	Housing & Development Board
	Er Tham Kwok Leong	Institution of Engineers, Singapore
	Er Mok Kam Tim, Timmy	Institution of Engineers, Singapore
	Er Yeow Mei Leng	Institution of Fire Engineers, Singapore
	Er Yee Poh Kin	Institution of Fire Engineers, Singapore
	Er Yee Peng Huey	JTC Corporation
	Mr Kwok Weng Yin	JTC Corporation
	Er Chiam Boon Hui	Land Transport Authority
	Mr Liew Ching Boon	Nanyang Technological University
	Mr Steven Leow	.	Real Estate Developers' Association of Singapore
	Mr Chan Weng Khoon	.	Real Estate Developers' Association of Singapore
	Mr Tan Guan Leong, Peter	Urban Redevelopment Authority
	Mr Chng Seng Yong, Joseph	Singapore Accreditation Council
	Ar Eng Yew Hoon PBM	Singapore Institute of Architects
	Ar Song Yew Kee (served till Nov 2016)	Singapore Institute of Architects
	Mr Heng Chai Liang	Singapore Civil Defence Force
	Mr Lee Wee Keong	Singapore Civil Defence Force
	LTC Choh Choon Jin	Singapore Civil Defence Force
	LTC Goh Boon Han	Singapore Civil Defence Force
	Mr Nicholas Lee	Singapore Civil Defence Force
Editorial Team:			
	CPT Ranneth Tan	Singapore Civil Defence Force
	CPT Gladis Choo	Singapore Civil Defence Force

Notice to Users of the Code of Practice for Fire Precautions in Buildings 2018

The Singapore Civil Defence Force (SCDF) reviews the Code of Practice for Fire Safety Precautions in Buildings (Fire Code) regularly to ensure relevance with new developments, such as changes in building construction methods, new/improved building materials, changing building risk profiles, etc..

The SCDF will periodically inform the building industry through circulars on all changes made to the Code, and will update the interactive version of the Code on its website when the changes take effect. Users are advised to visit the website at <http://www.scdf.gov.sg> to obtain the updated requirements.

CONTENTS

CHAPTER 01 : GENERAL

1.1 SCOPE

1.1.1	Rapid Transit System (RTS)	3
1.1.2	Fire safety requirements for laboratories handling hazardous chemicals . .	3
1.1.3	Fire safety requirements for road tunnels.	3
1.1.4	Fire safety report and fire safety instruction manual (<i>Appendix 1 & 2</i>)	3

1.2 CODES AND STANDARDS

1.2.1	Reference.	3
1.2.2	Conflicting requirements.	3

1.3 ABBREVIATIONS

1.4 DEFINITIONS

1.4.1	Accessible Floor Area (AFA)	4
1.4.2	Air well	4
1.4.3	Ambulatory healthcare centre	4
1.4.4	Ancillary office	4
1.4.5	Ancillary usage.	4
1.4.6	Anteroom	5
1.4.7	Approved	5
1.4.8	Area of compartment/room/space	5
1.4.9	Area of refuge.	5
1.4.10	Area of roof.	5
1.4.11	Area of storey.	5
1.4.12	Assembly occupancy	5
1.4.13	Atrium.	5
1.4.14	Authority having jurisdiction	6
1.4.15	Basement storey	6
1.4.16	Biological Agent	6
1.4.17	Boundary	6
1.4.18	Cavity barrier	6
1.4.19	Ceiling	6
1.4.20	Circulation space	6
1.4.21	Code of Practice (CoP)	6
1.4.22	Coldroom	7

1.4.23	Compartment	7
1.4.24	Compartment wall & compartment floor	7
1.4.25	Composite panel	7
1.4.26	Concealed space/Cavity	7
1.4.27	Corridor	7
1.4.28	Cross-ventilated corridor/lobby	7
1.4.29	Cubical extent	7
1.4.30	Custodian-care facility	8
1.4.31	Dead-end	8
1.4.32	Direct distance	8
1.4.33	Door	8
1.4.34	Electromagnetic or electromechanical door-holding device	8
1.4.35	Electromagnetic or electromechanical locking device	8
1.4.36	Element of structure	9
1.4.37	Emergency generator	9
1.4.38	Emergency lighting	9
1.4.39	Engineered timber	9
1.4.40	Evacuee holding area	9
1.4.41	Exit	9
1.4.42	Exit access	9
1.4.43	Exit access door	10
1.4.44	Exit door	10
1.4.45	Exit passageway	10
1.4.46	Exit staircase	10
1.4.47	External corridor	10
1.4.48	External exit passageway	10
1.4.49	External exit staircase	10
1.4.50	External space	10
1.4.51	External wall (or side of a building)	11
1.4.52	External wall finishes	11
1.4.53	Fire lift lobby	11
1.4.54	Fire resistance	11
1.4.55	Fire safety report	11
1.4.56	Fire stop	11
1.4.57	Flammable refrigerant	11
1.4.58	Flexible joints and flexible connections	11
1.4.59	Fire engine access road	12
1.4.60	Fire engine accessway	12

1.4.61	Fully Automated Mechanised Car Park (FAMCP)	12
1.4.62	General warehouse	12
1.4.63	Habitable floor	12
1.4.64	Habitable height	12
1.4.65	Height of building	12
1.4.66	High containment facility	13
1.4.67	High hazard occupancy	13
1.4.68	Hospital	13
1.4.69	Load-bearing wall	13
1.4.70	Masonry	13
1.4.71	Non-combustible material	13
1.4.72	Non-load-bearing wall	14
1.4.73	Notional boundary	14
1.4.74	Nursing home, convalescent home, home for the aged & hospice	14
1.4.75	Occupant load	14
1.4.76	Outdoor Display Area (ODA)	14
1.4.77	Outdoor Refreshment Area (ORA)	14
1.4.78	One-way travel	15
1.4.79	Permitted limit of unprotected area	15
1.4.80	Plastic	15
1.4.81	Private lift	15
1.4.82	Protected shaft	15
1.4.83	Protecting structure	15
1.4.84	Public building	16
1.4.85	Purpose Group (PG)	16
1.4.86	Refuge floor	16
1.4.87	Relevant boundary	16
1.4.88	Remoteness of exits	16
1.4.89	Roof light	16
1.4.90	Room	16
1.4.91	Singapore Civil Defence Force (SCDF)	17
1.4.92	Separated part (of a building)	17
1.4.93	Separating wall	17
1.4.94	Setback distance	17
1.4.95	Single point emergency lighting	17
1.4.96	Smoke-check door	17
1.4.97	Smoke-stop lobby	17
1.4.98	Storey	17

1.4.99	Super high-rise residential building	17
1.4.100	Supervisory care facility	17
1.4.101	Tenancy unit	18
1.4.102	Thermoplastics	18
1.4.103	Thermosetting plastic	18
1.4.104	Toxin	18
1.4.105	Travel distance	18
1.4.106	Two-way travel	18
1.4.107	Unmanned building	18
1.4.108	Unprotected area	19
1.4.109	Vertical exit	19
1.4.110	Wall surface	19
1.4.111	Workers' dormitories	19

CHAPTER 02 : MEANS OF ESCAPE

2.1 GENERAL

2.2 DETERMINATION OF EXIT REQUIREMENTS

2.2.1	General	41
2.2.2	Mixed occupancy	41
2.2.3	Multiple occupancy or use	41
2.2.4	Non-simultaneous occupancy	41
2.2.5	Capacity of exits and exit facilities	42
2.2.6	Determination of travel distance	42
2.2.7	Minimum width of exit access door, exit door or other exit facilities	43
2.2.8	Maximum width of exit staircases	43
2.2.9	Measurement of width	43
2.2.10	Number of exits from rooms and spaces	44
2.2.11	Number of exit staircases or exits per storey	44
2.2.12	Location of exits & access to exits	45
2.2.13	Smoke-free approach to exit staircase	45
2.2.14	Smoke-free approach to exit staircase in basement	47
2.2.15	Area of refuge and exit reduction	47

2.3 MEANS OF ESCAPE REQUIREMENTS

2.3.1	General	48
2.3.2	Exit passageways	49
2.3.3	Exit staircase	50

2.3.4	Scissor exit staircase	56
2.3.5	Basement exit staircase	56
2.3.6	Hardwood staircase	57
2.3.7	Spiral staircase	57
2.3.8	Exit ramp	57
2.3.9	Exit doors and exit access doors	58
2.3.10	External corridor	63
2.3.11	Air well	64
2.3.12	Remoteness of exits	64

2.4 SPECIAL REQUIREMENTS FOR PERSON WITH DISABILITIES (PWDS)

2.4.1	General	66
2.4.2	PWD Holding Point	66
2.4.3	Communication provisions	67
2.4.4	Dimension requirements of PWD Holding Point	67
2.4.5	Protection of PWD Holding Point	67
2.4.6	Exit staircase	68
2.4.7	Ramp	68

CHAPTER 03 : STRUCTURAL FIRE PRECAUTIONS

3.1 GENERAL

3.2 PROVISION OF COMPARTMENT WALLS AND COMPARTMENT FLOORS

3.2.1	Compartment size - floor area & cubical extent	79
3.2.2	Cubical extent for compartment exceeding 4m in height	79
3.2.3	Exemption of compartmentation	80
3.2.4	Compartmentation by height	80
3.2.5	Areas requiring compartmentation	80
3.2.6	Provision for atrium spaces	83
3.2.7	Buildings of high hazard occupancy	83
3.2.8	Exemption on size limitation of compartment	84
3.2.9	Separation of area undergoing addition & alteration works	84

3.3 FIRE RESISTANCE OF ELEMENTS OF STRUCTURE

3.3.1	Interpretation and application	84
3.3.2	Minimum periods of fire resistance	85
3.3.3	Exemption for non-load-bearing external walls	85
3.3.4	Exemption for single storey buildings	86
3.3.5	Suspended ceiling	86

3.3.6	Fire-rated board	86
3.4	TESTS OF FIRE RESISTANCE	
3.4.1	Fire resistance	87
3.4.2	“Deem to satisfy” provisions	87
3.5	EXTERNAL WALL	
3.5.1	Requirements of external walls	88
3.5.2	Exceptions on external wall construction	88
3.5.3	Unprotected areas in any side of a building	89
3.5.4	External wall finishes	89
3.5.5	Reference to Part I & II of Annex 3B	90
3.5.6	Buildings on land in common occupation	90
3.5.7	Vertical fire spread	90
3.5.8	Non-sprinkler-protected roof	91
3.5.9	Separation of residential floor facade	91
3.5.10	External sun-breakers/weather features	91
3.6	SEPARATING WALLS	
3.6.1	Requirements of separating walls	91
3.6.2	Openings in separating walls	92
3.6.3	Roof junction	92
3.6.4	External wall junction	92
3.6.5	Prohibition of combustible materials in separating walls	92
3.7	COMPARTMENT WALLS AND COMPARTMENT FLOORS	
3.7.1	Requirements of compartment walls or compartment floors	92
3.7.2	Openings in compartment wall or compartment floor	93
3.7.3	Openings	93
3.7.4	Compartment wall - roof junctions	93
3.7.5	Prohibition of combustible materials	93
3.7.6	Non-combustibility of compartment walls or floors	93
3.7.7	Use of fire shutter	94
3.7.8	Exit directional signage on fire shutter and smoke curtain	95
3.7.9	Emergency generator room	95
3.8	PROTECTED SHAFTS	
3.8.1	Purpose of protected shaft	95
3.8.2	Requirements of protected shaft	95
3.8.3	Openings in protected shaft	96

3.8.4	Non-combustibility of protecting structures	96
3.8.5	Ventilation of protected shaft	96
3.8.6	Doors in protecting structures	97
3.8.7	Protected shaft containing exit staircase	97
3.8.8	Lift shaft	98
3.8.9	Protected shaft containing other services installations.	99
3.9	PROTECTION OF OPENINGS	
3.9.1	Application	100
3.9.2	Fire doors	100
3.9.3	Pipes	101
3.9.4	Ventilation ducts	102
3.9.5	Flues.	103
3.9.6	Services passing through FCC, fire pump room, emergency generator room and smoke control fans room	103
3.9.7	Services running inside and/or passing through fire lift lobby and smoke-stop lobby	103
3.9.8	Gas pipes running inside an internal corridor/lobby	103
3.10	EXIT STAIRCASES	
3.10.1	Non-combustibility of structure	104
3.10.2	Compartmentation	104
3.10.3	Exit doors	104
3.10.4	Finishes	104
3.11	CONCEALED SPACES	
3.11.1	General provision	104
3.11.2	Closing the edges of cavities	104
3.11.3	Interrupting cavities	104
3.11.4	Sub-division of extensive cavities.	105
3.11.5	Fire resistance and fixing of cavity barriers	105
3.11.6	Openings in cavity barriers.	105
3.11.7	Raised floors for fixed stages and display platforms	105
3.11.8	Raised floors with or without accessible panels.	105
3.11.9	Provision for concealed spaces between floor or roof and suspended ceilings.	107
3.11.10	Exemption of cavity barriers in ceiling space	107
3.11.11	Suspended ceiling over protected areas	107
3.11.12	Exemption	108

3.12 FIRE STOPPING

3.12.1	General provision	108
3.12.2	Fire-stopping	108
3.12.3	Materials for fire-stopping.	108

3.13 CLASSIFICATION OF SPREAD OF FLAME

3.13.1	Requirements for Class 0	109
3.13.2	Class other than Class 0	109
3.13.3	Order of classification.	109
3.13.4	Class of flame spread to be not lower than specified	110
3.13.5	Where class of flame spread can be of any class not lower than Class 3	110
3.13.6	Exception	111
3.13.7	Composite panel	111

3.14 ROOFS

3.14.1	Roof construction	111
3.14.2	Provision for buildings not exceeding four storeys.	112
3.14.3	Roof junction with separating wall and compartment wall	112

3.15 MATERIALS FOR CONSTRUCTION

3.15.1	General.	112
3.15.2	Intumescent paint.	112
3.15.3	Flame retardant chemicals	113
3.15.4	Elements of structure	113
3.15.5	Protection of openings	113
3.15.6	Exit staircases	114
3.15.7	Raised floors	114
3.15.8	Ceiling and ceiling supports	114
3.15.9	Fire-stopping	114
3.15.10	Surfaces of walls and ceilings	114
3.15.11	Roof construction	114
3.15.12	Internal non-load-bearing walls	114
3.15.13	Composite panel	114
3.15.14	Fire-rated glass	115
3.15.15	Walls, ceilings, roof covering and finishes	115
3.15.16	Separation of areas undergoing A&A works.	115
3.15.17	Partition for toilet cubicles	115
3.15.18	Timber floors	115
3.15.19	Use of plastics in building construction	116

3.15.20	UPVC window frame	117
ANNEX 3A -	NOTIONAL PERIODS OF FIRE RESISTANCE	137
ANNEX 3B -	LIMITS OF UNPROTECTED OPENINGS	157

CHAPTER 04 : SITE PLANNING & EXTERNAL FIREFIGHTING PROVISION

4.1	GENERAL	
4.2	PROVISION FOR EXTERNAL ACCESS TO BUILDING FOR FIREFIGHTING AND ACCESSIBILITY OF SITE TO FIREFIGHTING APPLIANCES	
4.2.1	General	175
4.2.2	Fire engine accessway and fire engine access road	175
4.2.3	Fire access opening to building for firefighting	180
4.3	ACCESS TO BUILDINGS WITH RISING MAINS	
4.4	PRIVATE FIRE HYDRANT	
4.4.1	Provision of private fire hydrant	181
4.4.2	Water supply for private fire hydrant	182
4.4.3	Protection of fire hydrant mains in buildings	184

CHAPTER 05 : ELECTRICAL POWER SUPPLIES

5.1	GENERAL	
5.2	PRIMARY AND SECONDARY POWER SUPPLIES	
5.2.1	Installations requiring primary and secondary power supplies	201
5.2.2	Cable installation	203
5.2.3	Electric motors and control equipment	203
5.2.4	Emergency generator	203

CHAPTER 06 : FIREFIGHTING SYSTEMS

6.1	PORTABLE EXTINGUISHERS	
6.1.1	General	207
6.1.2	Provision	207
6.1.3	Type, size and siting	207
6.1.4	Installation and marking	207
6.2	RISING MAIN AND HOSE REEL SYSTEMS	

6.2.1	Type of rising mains	207
6.2.2	Number, location and size of rising mains	208
6.2.3	Breeching inlets and fire engine accessway/fire engine access road . . .	209
6.2.4	Wet rising mains	209
6.2.5	Standby fire hose for rising mains	210
6.2.6	Building under construction	211
6.2.7	Foam inlets	211
6.2.8	Hose reels	212
6.2.9	Graphical symbols	213
6.3	ELECTRICAL FIRE ALARM SYSTEM	
6.3.1	General	214
6.3.2	Fire alarm panel	214
6.3.3	Manual alarm call points	215
6.3.4	Automatic fire alarm	216
6.3.5	Alarm device.	216
6.3.6	Home Fire Alarm Device (HFAD)	217
6.3.7	Alarm system for cinema	218
6.3.8	Connection to the SCDF Operations Centre	219
6.3.9	Sprinkler-protected building	219
6.3.10	Exemption of automatic fire alarm protection.	219
6.3.11	Video Image Fire Detection System (VIFDS)	219
6.4	FIRE SPRINKLER INSTALLATION	
6.4.1	Provision	220
6.4.2	Standard.	222
6.4.3	System design	222
6.4.4	Special purpose rooms	223
6.4.5	Car park	223
6.4.6	Water mist systems	223
6.4.7	Reduced water storage for automatic fire sprinkler system	224
6.4.8	Combined sprinkler and wet riser systems.	225
6.5	FIXED AUTOMATIC FIRE EXTINGUISHING SYSTEMS	
6.5.1	Installation	226
6.5.2	Design standard.	226
6.6	LIFTS	
6.6.1	General.	226
6.6.2	Lift well ventilation	226

6.6.3	Emergency power supply	226
6.6.4	Fire lift	227
6.6.5	Evacuation lift.	228
6.6.6	Homing of lifts.	230
6.6.7	Provisions for lift rescue	232

6.7 COLOUR SCHEME OF FIRE PROTECTION SYSTEMS

6.7.1	Equipment, fixtures and fittings	234
6.7.2	Pipework, conduits, trunkings and cable trays	235

6.8 REDUNDANCY FOR FIRE PUMPING SYSTEM

CHAPTER 07 : MECHANICAL VENTILATION & SMOKE CONTROL SYSTEMS

7.1 AIR-CONDITIONING AND MECHANICAL VENTILATION SYSTEMS

7.1.1	General	251
7.1.2	Construction of ductwork	251
7.1.3	Pipework.	252
7.1.4	Air plenum	253
7.1.5	Fire Dampers	254
7.1.6	Fire resisting floor ceiling and roof ceiling	256
7.1.7	Locations of intakes and return air openings	256
7.1.8	Air handling unit (AHU) room	256
7.1.9	Ventilation system for exits	257
7.1.10	Ventilation system for smoke-stop lobby and fire lift lobby.	258
7.1.11	Ventilation system for engine-driven fire pump room and generator room.	258
7.1.12	Ventilation system for Fire Command Centre (FCC)	259
7.1.13	Exhaust system for kitchen	259
7.1.14	Ventilation system for rooms involving use of flammable and explosive substances	261
7.1.15	Ventilation system for rooms housing batteries	262

7.2 PRESSURISATION FOR EXIT STAIRCASES

7.2.1	Provision.	262
7.2.2	Pressurisation level	263
7.2.3	Egress velocity	263
7.2.4	Leakages	263
7.2.5	Distribution of pressurising air	264

7.2.6	Pressurisation equipment and controls	264
7.3	PRESSURISATION OF INTERNAL CORRIDORS IN HOTELS	
7.3.1	Pressure differences	264
7.4	SMOKE CONTROL SYSTEM	
7.4.1	Provision.	264
7.4.2	Smoke vent	265
7.4.3	Smoke purging system.	266
7.4.4	Ductless jet fan system	266
7.4.5	Engineered smoke control system.	270
7.5	REDUNDANCY FOR MECHANICAL VENTILATION AND PRESSURISATION SYSTEMS	
7.5.1	Provision.	279

CHAPTER 08 : EMERGENCY LIGHTING & VOICE COMMUNICATION SYSTEMS

8.1	EXIT LIGHTING AND EXIT SIGN	
8.1.1	Exit lighting.	287
8.1.2	Emergency lighting for corridors and lobbies.	287
8.1.3	Emergency lighting for occupied areas	287
8.1.4	Emergency lighting for firefighting facilities	288
8.1.5	Secondary source of power supply	288
8.1.6	Luminaire	288
8.1.7	Exit and exit directional signs.	288
8.1.8	Photoluminescent marking.	290
8.2	EMERGENCY VOICE COMMUNICATION SYSTEM AND FIRE COMMAND CENTRE (FCC)	
8.2.1	One-way emergency voice communication system.	291
8.2.2	Two-way emergency voice communication system	292
8.2.3	Standard.	292
8.2.4	Fire Command Centre	293

CHAPTER 09 : ADDITIONAL REQUIREMENTS FOR EACH PURPOSE GROUP

9.1	PURPOSE GROUP I OCCUPANCY	
9.1.1	General.	301

9.2	PURPOSE GROUP II OCCUPANCY	
9.2.1	General.	302
9.2.2	Super high-rise residential building	305
9.3	PURPOSE GROUP III OCCUPANCY	
9.3.1	General.	309
9.3.2	Healthcare occupancy	309
9.3.3	Workers' dormitory	314
9.3.4	Temporary workers' quarter in uncompleted permanent buildings on construction sites.	315
9.4	PURPOSE GROUP IV OCCUPANCY	
9.4.1	General.	319
9.5	PURPOSE GROUP V OCCUPANCY	
9.5.1	General.	320
9.5.2	Outdoor Display Areas (ODAs)	320
9.6	PURPOSE GROUP VI OCCUPANCY	
9.6.1	General.	328
9.6.2	Petroleum service stations	328
9.6.3	High containment facilities	335
9.7	PURPOSE GROUP VII OCCUPANCY	
9.7.1	General.	342
9.7.2	Hotels, boarding houses, serviced apartments, hostels & backpacker hotels	342
9.7.3	Assembly occupancy	343
9.7.4	Outdoor Refreshment Areas (ORAs)	348
9.8	PURPOSE GROUP VIII OCCUPANCY	
9.8.1	General.	360
9.8.2	Coldroom	361
9.8.3	General warehouses	362
9.8.4	Chemical/HazMat warehouses.	365
9.8.5	Fully Automated Mechanised Car Parks (FAMCPs).	368
9.9	OTHERS	
9.9.1	Buildings designated for conservation and buildings built before 1969	385
9.9.2	Temporary buildings on construction sites	390
9.9.3	Buildings under construction	390

9.9.4	Use of hoardings and safety nets for alteration and alteration work	391
9.9.5	Engineered timber building construction	392
9.9.6	Use of flammable refrigerants	394
9.9.7	Mega underground developments	395

ANNEX 9.9A - INSPECTION CHECKLIST FOR BUILDING UNDER CONSTRUCTION	404
--	------------

CHAPTER 10 : REQUIREMENTS FOR SPECIAL INSTALLATIONS

10.1 LIQUEFIED PETROLEUM GAS (LPG) CYLINDER INSTALLATION

10.1.1	General	409
10.1.2	Design requirements	410
10.1.3	Outdoor LPG cylinder installation.	410
10.1.4	Indoor LPG cylinder installation	413
10.1.5	Gas leak detection system and other requirements.	416
10.1.6	Reduced separation distances between LPG storage and boundaries . .	417

10.2 SOLAR PHOTO-VOLTAIC (PV) INSTALLATION

10.2.1	General.	426
10.2.2	Means of access	426
10.2.3	Fire resistance of PV modules	426
10.2.4	Design and installation criteria	426
10.2.5	Emergency disconnection	427

ANNEX 10.1A -STANDARDS AND SPECIFICATIONS FOR LPG CYLINDER INSTALLATIONS	429
---	------------

ANNEX 10.1B -CONDITIONS FOR INDOOR STORAGE/USE OF LPG IN EATING OUTLETS.	435
---	------------

CHAPTER 11 : REGULATED FIRE SAFETY PRODUCTS & MATERIALS

11.1 GENERAL

11.2 DEFINITION

11.2.1	Product Listing Scheme (PLS).	441
11.2.2	Certificate of Conformity (CoC)	441
11.2.3	Declaration of Compliance (DoC).	441
11.2.4	Mutual Recognition Arrangement (MRA)	441
11.2.5	Scheme Type 1b (Scheme 1b)	441
11.2.6	Scheme Type 2 (Scheme 2).	441

11.2.7	Scheme Type 5 (Scheme 5).....	442
11.2.8	Discrete System.....	442
11.2.9	Non-discrete system.....	442

11.3 ASSESSMENT AND VALIDATION

11.3.1	Assessment of modification to certified fire safety products and materials.....	442
11.3.2	Validity of test reports for regulated fire safety products and materials.....	442
11.3.3	Validity of CoC for regulated fire safety product and materials.....	443

ANNEX 11A - ADMINISTRATIVE REQUIREMENTS..... 462

APPENDICES

APPENDIX 01	: FIRE SAFETY REPORT.....	469
APPENDIX 02	: FIRE SAFETY INSTRUCTION MANUAL.....	475
APPENDIX 03	: CLAUSE HISTORY.....	483

CHAPTER

01

GENERAL

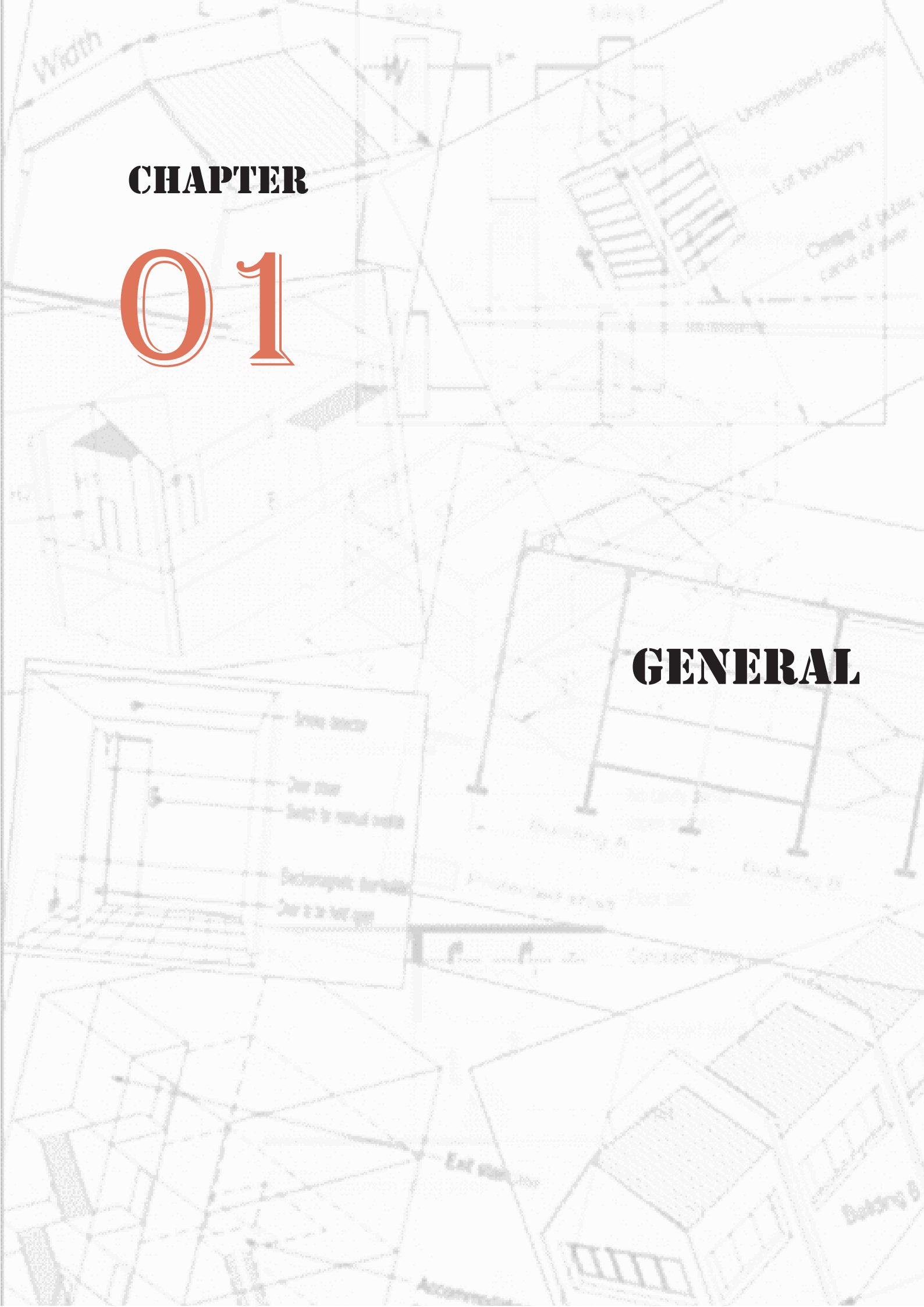

CHAPTER

1

GENERAL

1.1 SCOPE

The Code of Practice for Fire Precautions in Buildings, hereinafter called “the Code” or “this Code”, serves to establish the minimum requirements for fire safety provisions in all buildings. It takes into account the function, design, management, operation, and maintenance of buildings to secure the life safety of occupants and property safety in the event of a fire.

1.1.1 Rapid Transit System (RTS)

Fire safety requirements for underground, surface and elevated RTS including trainways, transit stations, train maintenance depots, on-line electric substations and RTS facility buildings, shall comply with “Code of Practice for Fire Precautions in Rapid Transit Systems”.

1.1.2 Fire safety requirements for laboratories handling hazardous chemicals

For laboratory storing and using chemicals/HazMat shall be in compliance with NFPA 45, except for the Maximum Allowable Quantity (MAQ) which shall comply with the figures released by SCDF.

1.1.3 Fire safety requirements for road tunnels

Fire safety requirements for road tunnels shall be in compliance with NFPA 502.

1.1.4 Fire safety report and fire safety instruction manual ([Appendix 1 & 2](#))

Fire safety report and/or fire safety instruction manual for building projects/fire safety provisions specified by SCDF shall be submitted when making building plan submission.

1.2 CODES AND STANDARDS**1.2.1 Reference**

This Code makes reference to numerous local and international codes of practice and standards. Only the latest version of the codes of practice and standards shall be used for the purpose of this Code. A list of such codes of practice and standards is as shown in [Table 1.2A](#).

1.2.2 Conflicting requirements

All codes of practice and standards which this Code referred to shall be read in conjunction with the relevant clauses in this Code. Where conflict exists between this Code and the referred codes of practice and/or standards, the requirements stipulated in this Code shall take precedence.

1.3 ABBREVIATIONS

The abbreviations used in this Code are listed in [Table 1.3A](#).

1.4 DEFINITIONS

In this Code, unless the context otherwise requires, the following definitions will apply.

1.4.1 Accessible Floor Area (AFA)

“Accessible floor area” refers to the total floor area of all covered spaces within a building, including service ducts, lift shafts, toilets, staircases, areas occupied by fixed/moveable furniture/equipment/facilities, and any open-to-sky habitable areas above or below the first storey of the building.

1.4.2 Air well

“Air well” refers to a space(s) enclosed substantially by building(s) and directly open to the sky. An air well can be considered as an external space if it meets the minimum clear width and length below:

TABLE 1.4.2 - AIR WELL SIZE	
Max. Habitable Height of Building	Min. Clear Width and Length of Air Well
18m	10m
24m	11m
36m	12m
48m	13m
60m and above	14m

1.4.3 Ambulatory healthcare centre

“Ambulatory healthcare centre” is a building, or part thereof, used for providing services on an out-patient basis for treatment for patients which would render them incapable of taking action for self-preservation or safety under emergency conditions without assistance from others, such as haemodialysis units or surgical treatment requiring general anaesthesia.

1.4.4 Ancillary office

“Ancillary office” refers to any office which supports the activities of a building within Purpose Groups III, V, VI, VII and VIII and which is located within the same building or compartment as the purpose group it serves.

1.4.5 Ancillary usage

“Ancillary usage” refers to a room/space that serves a supporting function, and which belongs to the same purpose group as the primary building. Such rooms include sick/first aid rooms, reception lobbies/areas, waiting areas, staff lounges/staff recreation rooms, staff

changing/locker rooms, staff training rooms, meeting rooms, etc.. It also refers to workshops, laboratories (no open flame), store rooms, material/product holding areas, packing distribution areas within factories/warehouse buildings.

1.4.6 Anteroom

“Anteroom” refers to the room leading into the BSL-3 or BSL-4 containment laboratory, used for showering and changing. It also serves as a containment facility for controlling air flow and providing additional physical containment between the laboratory and adjoining spaces.

1.4.7 Approved

“Approved” refers to being approved by the SCDF.

1.4.8 Area of compartment/room/space

“Area of compartment/room/space” refers to the total area of any compartment/room/space bounded by the inner finished surfaces of the walls that form the compartment/room/space. Where there is no enclosing wall on any one side, the area of the compartment/room/space shall be measured by the outermost edge of the floor on that side.

1.4.9 Area of refuge

“Area of refuge” refers to an area within a building, or in an adjoining building, where evacuees can temporarily take refuge, in lieu of the requirement for adequate exit staircase provision. It shall be adequately separated from the rest of the building or adjoining building by fire-resisting construction, and connected via an external corridor or open-sided linkway. The area of refuge shall be always accessible.

1.4.10 Area of roof

“Area of roof” refers to the visible roof area on a plane parallel to the pitch of the roof.

1.4.11 Area of storey

“Area of storey” refers to the total area of that storey bounded by the inner finished surfaces of the enclosing walls. Where there is no enclosing wall on any one side, the area of storey shall be measured by the outermost edge of the floor on that side.

1.4.12 Assembly occupancy

“Assembly occupancy” refers to buildings or portions of buildings used for gathering of more than 50 persons for such purpose as deliberation, worship, entertainment, eating, drinking, amusement or awaiting transportation.

1.4.13 Atrium

“Atrium” refers to a large open space within a building created by an opening, or a series of openings, in floor assemblies, thus connecting two or more storeys. An atrium is

covered at the top and is used for purposes other than those associated with small shafts, e.g., stairs, elevators and various services. The sides of the atrium can be open to all floors, to some floors or closed to all floors by non-rated or rated fire-resistant construction.

1.4.14 Authority having jurisdiction

“Authority having jurisdiction” refers to non-SCDF local entities, which may include an organisation, office, or individual responsible for enforcing the requirement of a code or standard, or for approving equipment, materials, an installation, or a procedure.

1.4.15 Basement storey

“Basement storey” refers to a storey of a building for which at least half the storey height is below the ground level, and which also adjoins its perimeter walls for at least half the length of such walls.

1.4.16 Biological Agent

“Biological Agent” refers to the biological agents stipulated in the First Schedule, Second Schedule and Third Schedule of the Biological Agents and Toxins Act.

1.4.17 Boundary

“Boundary” refers to the border demarcating the area surrounding a building, and where applicable (in determining the relevant boundary), it includes the imaginary extension of the border up to the centre of an abutting street, canal or river.

1.4.18 Cavity barrier

“Cavity barrier” refers to a fire-rated construction that seals or sub-divides a concealed space. The cavity barrier helps limit the spread of smoke and fire into or within that concealed space.

1.4.19 Ceiling

“Ceiling” refers to a part of a building that encloses and is exposed overhead in a room, circulation space or protected shaft. A soffit or rooflight is regarded as part of its surface, but not the frame of a rooflight.

1.4.20 Circulation space

“Circulation space” refers to the means of access between a room or protected shaft and an exit from the building or compartment. It does not include areas used for any commercial activity, such as information and reception counters, or areas used for exhibitions.

1.4.21 Code of Practice (CoP)

“Code of Practice” refers to the standard of practice acceptable to the authority having jurisdiction. The SCDF may adopt requirements stipulated in the stated year of publication of any referenced Code of Practice, or at its discretion adopt those specified in a

later version.

1.4.22 Coldroom

“Coldroom” refers to a room, normally constructed of combustible insulation materials, used for the storage, processing or temporary holding of materials under cold conditions. If the floor area of cold storage space does not exceed 10m² and its design does not permit persons to walk in, it shall be treated as an appliance and not a coldroom.

1.4.23 Compartment

“Compartment” refers to a part of a building separated from all other parts of the same building by compartment walls and/or compartment floors. The roof space above the top storey of a compartment is regarded as part of that compartment.

1.4.24 Compartment wall & compartment floor

“Compartment wall” and “compartment floor” refer to walls or floors of fire-rated construction provided for the purpose of dividing a building into compartments.

1.4.25 Composite panel

“Composite panel” refers to non-homogenous panel consisting of more than one layer of different materials used for partition, finishes to ceiling/internal wall/external walls/ roof covering, etc..

1.4.26 Concealed space/Cavity

“Concealed space/Cavity” refers to a space enclosed by elements of a building (including a suspended ceiling or raised floor) or contained within an element. It is not a room, cupboard, circulation space, protected shaft or space within a flue, chute, duct, pipe or conduit.

1.4.27 Corridor

“Corridor” refers to a passage providing means of access from rooms or spaces to an exit.

1.4.28 Cross-ventilated corridor/lobby

“Cross-ventilated corridor/lobby” refers to a corridor/lobby with fixed and unobstructed ventilation openings located on opposite facing walls, which face the external space, to allow for air circulation caused by outside breezes or wind.

1.4.29 Cubical extent

“Cubical extent” refers to the volume of a space within a building or compartment. This excludes protected lift walls, exit staircases and other accommodation (such as restrooms and locker rooms) which are enclosed with walls having at least 1-hr fire resistance, and openings protected by doors of ½-hr fire resistance fitted with an automatic self-closing device. It shall be measured according to the following dimensions:

CHAPTER 01

- a. the inner finished surfaces of the enclosing walls or, on any side where there is no enclosing wall, a plane extending vertically above the outermost edge of the floor on that side,
- b. the upper surface of its lowest floor; and
- c. where a building or compartment extends to a roof, the under-surface of the roof or the under-surface of the ceiling of the highest storey within the compartment, including the space occupied by any other wall, or any unprotected shafts, ducts or structure within the space to be so measured.

1.4.30 Custodian-care facility

“Custodian-care facility” is a building or part thereof, without stay in accommodation, used by persons who, because of age, or physical or mental disabilities, are unable to care for their self-preservation and safety. Such buildings shall include nurseries for children under 6 years of age, senior day care centres and institutions for the mentally disabled.

1.4.31 Dead-end

“Dead-end” refers to a situation within a common area, such as a corridor or lift lobby space, where exit is only possible from one end, with no possible escape from the other end.

1.4.32 Direct distance

“Direct distance” refers to the shortest distance from the most remote point in a room or space, measured within the external enclosures of the room or space to the relevant exits, ignoring internal walls, partitions and fittings other than the enclosure walls of exit passageways and exit staircases.

1.4.33 Door

“Door” refers to any shutter, cover or other form of protection to an opening in any wall, floor or in the structure surrounding a protected shaft, regardless of whether the door is constructed of one or more leaves.

1.4.34 Electromagnetic or electromechanical door-holding device

“Electromagnetic” or “electromechanical door-holding device” refers to a device which holds doors open. This device is designed to automatically close doors in the event of a fire, thereby helping to contain the spread of smoke and fire. Events which cause these devices to trigger include the detection of smoke, failure of power supply to the door, the triggering of a fire alarm, and manual triggering.

1.4.35 Electromagnetic or electromechanical locking device

“Electromagnetic” or “electromechanical locking device” refers to a fail-safe device which provides access control. This device is designed to automatically unlock doors in the event of a fire, thereby helping to facilitate evacuation. An electromagnetic/electromechanical locking device shall be provided with a means of manual override located within the occupied

space, 1.2m above the floor and within 1.5m of the door jamb.

1.4.36 Element of structure

“Element of structure” refers to:

- a. a member forming part of the structural frame of a building or any other beam or column but not a member forming part of a roof structure only,
- b. a load-bearing wall or load-bearing part of a wall,
- c. a floor, including a compartment floor, other than the lowest floor (in contact with the ground) of a building,
- d. a separating wall, or
- e. a structure enclosing a protected shaft (protecting structure).

1.4.37 Emergency generator

“Emergency generator” refers to emergency power-generating equipment that complies with the requirements stipulated in SS 535.

1.4.38 Emergency lighting

“Emergency lighting” refers to lighting provided with a secondary source of power supply to illuminate the exits and spaces within a building.

1.4.39 Engineered timber

“Engineered timber” refers to mass timber products that are manufactured according to established standards accepted by the SCDF. Examples of mass timber products are cross laminated timber (CLT) and glued laminated timber (GLT) structural elements manufactured in accordance with EN 16351 and EN 14080 respectively.

1.4.40 Evacuee holding area

“Evacuee holding area” refers to a designated circulation area/space on the refuge floor for temporary assembly of occupants during a fire emergency.

1.4.41 Exit

“Exit” refers to a means of egress from the interior of the building to an external space. An exit includes any of the following, either singly or in combination: a door opening leading to external space, exit staircase, exit ramp and/or exit passageway, but not including an access stair, aisle, corridor door or corridor and an access door to a room or space.

1.4.42 Exit access

“Exit access” refers to the portion of a means of escape that leads to an exit. It includes the room and building spaces that people occupy, as well as the doors along the escape routes,

CHAPTER 01

lobbies, aisles, passageways, corridors, access stairs and ramps traversed in order to reach an exit.

1.4.43 Exit access door

“Exit access door” refers to a door which provides access to a room or space (excluding a toilet cubicle, bedroom, storeroom, utility room, pantry and the like), or installed across the escape path leading to an exit.

1.4.44 Exit door

“Exit door” refers to a door, including a door which opens to the external space, provided at the doorway of an exit for the passage of people, which forms part of the integrity of the exit.

1.4.45 Exit passageway

“Exit passageway” refers to the horizontal extension of a vertical exit via an exit staircase or passage leading from a habitable area to an external space.

1.4.46 Exit staircase

“Exit staircase” refers to a staircase constructed of noncombustible material and protected from fire (by fire-rated construction or located at the external space) for the purpose of enabling egress to the external space.

1.4.47 External corridor

“External corridor” refers to a corridor with an unobstructed and uninterrupted ventilation opening that measures at least 1.2m in vertical height, the latter which is located above its parapet wall.

1.4.48 External exit passageway

“External exit passageway” refers to an exit passageway that serves as required exit with at least one of its longest sides open to the external space or air well.

1.4.49 External exit staircase

“External exit staircase” refers to an exit staircase located outside a building, open to the external space, and that:

- a. is enclosed by parapet walls or railing of not more than 1.1m in height; and
- b. has at least two adjacent sides or one of its longest sides abutting the external space.

1.4.50 External space

“External space” refers to an open space abutting the perimeter of a building, which includes an air well and which is vertically open to the sky without any roof or trellis.

1.4.51 External wall (or side of a building)

“External wall” or “external side of a building” refers to an outer wall or vertical enclosure. This includes a part of the roof pitched at an angle of 70° or more to the horizontal, if that part of the roof adjoins a space within the building to which persons have access.

1.4.52 External wall finishes

“External wall finishes” refers to materials/components installed on the building facade for the purpose of providing thermal insulation, weather resistance and/or to improve the appearance of buildings. They can be made of timber, metal, brick/stone granite, vinyl, composite materials, etc.. It shall include cladding, fins and any decorative features mounted on the external walls of a building.

1.4.53 Fire lift lobby

“Fire lift lobby” refers to a protected and ventilated or pressurised lobby into which a fire lift opens, and from which direct access to a protected staircase can be made for the purpose of firefighting.

1.4.54 Fire resistance

“Fire resistance” refers to the minimum period of time during which an element of structure or building element can be expected to function satisfactorily while subjected to a standard fire test.

1.4.55 Fire safety report

“Fire safety report” refers to a document that details the provision of fire protection systems, life safety features and fire safety management for a building, plant or installation.

1.4.56 Fire stop

“Fire stop” refers to a seal provided to close an imperfection of fit or any joint between elements, components or construction in a building, which serves to prevent/limit the passage of smoke and flame through that imperfection or joint.

1.4.57 Flammable refrigerant

“Flammable refrigerant” refers to the group of refrigerants with flammability classification of group 2 or 3 in accordance to ISO 5149. For refrigerant blends which have more than one flammability classification, the most unfavourable classification shall be taken for the purpose of this definition. Most of these flammable refrigerants are hydrocarbon (HC) based. Some examples of HC refrigerant include propane, butane and isobutane.

1.4.58 Flexible joints and flexible connections

For air-conditioning and mechanical ventilation systems:

- a. “flexible joints” refer to connections between ducts and equipment normally provided to isolate vibration and to allow thermal movement; and

- b. “flexible connections” refer to flexible sections of ducts provided to connect the extremity of ventilation ductwork to terminal units, extract units and grilles.

1.4.59 Fire engine access road

“Fire engine access road” refers to a road designed for firefighting appliances gain access to, and travel within a development for firefighting operations.

1.4.60 Fire engine accessway

“Fire engine accessway” refers to a metalled or paved road located along the perimeter of a building to allow a firefighting appliance to carry out firefighting operations. Compared to a fire engine access road, a fire engine accessway is designed to withstand a higher tonnage, and with a larger width, for the purpose of deploying firefighting appliances during an operation.

1.4.61 Fully Automated Mechanised Car Park (FAMCP)

“Fully automated mechanised car park” refers to a building or part of a building that is intended for the storage/parking of passenger vehicles employing fully automated mechanical facilities to move the vehicle from the point of entry to the parking deck and vice-versa. The parking area would be accessible by trained staff when carrying out maintenance works only. The automatic parking system is to be deactivated during the maintenance operations.

1.4.62 General warehouse

“General warehouse” refers to a building or space used for storing various types of goods or materials. It includes warehouses for storing chemicals, fresh/perishable food products (coldroom), etc.. Store having floor area more than 100m² shall be classified as warehouse.

1.4.63 Habitable floor

“Habitable floor” refers to all floors in a building, including the roof level. The roof level can be taken as non-habitable if it is not used for any purpose/activity other than housing M&E and/or telecommunication plants/equipment, e.g. lift motors, fire pumps, generators, fire hose reel pumps, water supply pumps, water tanks, cooling towers, solar photovoltaic panels, supply/exhaust fans with associated ductwork, air-con condensing units, telecommunication antenna, satellite dishes and public warning sirens, etc..

1.4.64 Habitable height

“Habitable height” refers to the height measured from the lowest level of fire engine accessway or fire engine access road (applicable to buildings under Purpose Group II) to the finished floor level of the highest habitable floor.

1.4.65 Height of building

“Height of building” refers to the vertical distance measured from the average level of the ground adjoining the outside of the external walls of the building to the level of half the

vertical height of the roof of the building or part, or the top of the walls or of the parapet (if any), whichever is higher.

1.4.66 High containment facility

“High containment facility” refers to containment laboratory, including the interstitial space, waste treatment area, anteroom, etc.) of Bio-safety Level 3 [BSL-3] and maximum containment laboratory of Bio-safety Level 4 [BSL-4] as defined in the WHO Laboratory Bio-Safety Manual. They are designed to comply with the requirements of WHO and authorities having jurisdiction for storing or handling of biological agents.

1.4.67 High hazard occupancy

“High hazard occupancy” refers to any occupancy in which the contents or activities include one or more of the following:

- a. materials with auto-ignition temperature lower than 200°C,
- b. materials that produce poisonous, noxious fumes, or flammable vapour,
- c. materials that cause explosions,
- d. high hazard occupancies stipulated under SS CP 52, or
- e. highly combustible substances and/or flammable liquids.

1.4.68 Hospital

“Hospital” is a building used for medical and surgical care and shall include healthcare facilities with 24-hr or inpatient services, such as general hospitals, hospitals for psychiatric care, children's hospitals, etc..

1.4.69 Load-bearing wall

“Load-bearing wall” refers to a wall which supports any load in addition to its own weight.

1.4.70 Masonry

“Masonry” refers to brick or concrete construction.

1.4.71 Non-combustible material

“Non-combustible material” refers to any material which neither burns nor gives off flammable vapour in sufficient quantity to ignite when subjected to the test for combustibility prescribed in BS 476 Part 4, and includes materials of limited combustibility, such as:

- a. any material of density 300 kg/m³ or more, which when tested in accordance with BS 476: Part 11, does not flame, and the rise in temperature on the furnace thermocouple is not more than 20°C;
- b. any material with a non-combustible core at least 8mm thick having

combustible facings (on one or both sides) not more than 0.5mm thick; and

- c. any material of density less than 300 kg/m³, which when tested in accordance with BS 476: Part 11,
 - (1) does not flame for more than 10 sec;
 - (2) the rise in temperature on the centre (specimen) thermocouple is not more than 35°C; and
 - (3) the rise in temperature on the furnace thermocouple is not more than 25°C.

1.4.72 Non-load-bearing wall

“Non-load-bearing wall” refers to a wall which supports no load other than its own weight.

1.4.73 Notional boundary

“Notional boundary” refers to an imaginary boundary which exists at equal distance between buildings on the same site, or the centre of the width of a public road/ drain/ sewer reserve, provided that the boundary is fronting the respective reserves.

1.4.74 Nursing home, convalescent home, home for the aged & hospice

These refer to a building, or part thereof, used for the housing and nursing care of persons on a 24hr basis who, because of physical incapacity, may be unable to care for their own needs and safety without assistance of other persons.

1.4.75 Occupant load

“Occupant load” of a building, or part thereof, refers to the total number of persons that can occupy such a building, or part thereof, at any one time. The “occupant load” shall be determined via

- a. the floor area(s) available for occupation based on the appropriate areas per person as stated in [Table 1.4B](#), or
- b. by the number of fixed seating, if applicable, for assembly occupancies.

1.4.76 Outdoor Display Area (ODA)

“Outdoor display area” refers to an area along the common walkways in front of their shops where the shop owner/operator display his merchandises. The area can be open-to-sky, covered or roofed-over with extended awning/canopy.

1.4.77 Outdoor Refreshment Area (ORA)

“Outdoor refreshment area” refers to an area along the common walkways in front of their eating houses, restaurants, coffee shops, hawker centres, fast food outlets, cafeterias, canteens, pubs, bars and the like by their respective food & beverage outlet’s owner/

operator. The area can be open-to-sky, covered or roofed-over with umbrella or extended awning/canopy.

1.4.78 One-way travel

“One-way travel” refers to a situation where occupants within a space can only travel in a single route/direction, from the most remote point, to an exit or a splitting point to reach multiple exits.

1.4.79 Permitted limit of unprotected area

“Permitted limit of unprotected area” refers to the maximum aggregate area of unprotected areas in any side or external wall of a building or compartment.

1.4.80 Plastic

“Plastic” refers to any group of organic materials which, though stable in use at ambient temperatures, are plastic at some stage in their manufacture and then can be shaped by the application of heat and/or pressure. Plastics can be categorised as either thermoplastics or thermosetting plastics.

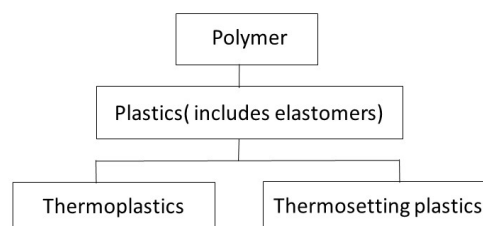

Categorisation of plastics

1.4.81 Private lift

“Private lift” refers to a passenger lift which is meant for the exclusive use of occupants in the building, and is located to open its door directly into private enclosed spaces. Vehicle lifts, home lifts and stair lifts are not considered private lifts.

1.4.82 Protected shaft

“Protected shaft” refers to an exit staircase, exit passageway, lift, chute, duct or other shaft which enables persons, things or air to pass from one compartment to another.

1.4.83 Protecting structure

“Protecting structure” refers to a wall, floor or other part of the building which encloses a protected shaft. The following are not considered protecting structure:

- a. a wall which also forms part of an external wall, separating wall or compartment wall, or

CHAPTER 01

- b. a floor which is also a compartment floor or a floor laid directly on the ground, or
- c. a roof.

1.4.84 Public building

“Public building” refers to a building, or part thereof, that is used, constructed or adapted to be used as a shop, office, hospital or place of public resort. Places of public worship such as churches, chapels, mosques, temples and places where religious ceremonies are performed are not considered public buildings.

1.4.85 Purpose Group (PG)

“Purpose Group” refers to the categorisation of buildings in this Code, with the aim of specifying relevant fire safety criteria for that building type. Where a building is divided into compartments used for different purposes, the purpose group of each compartment shall be determined individually, provided that where the whole or part of a building or compartment is used for more than one purpose, only the main purpose of that building or compartment shall be taken into account in determining into which purpose group it falls. (See [Table 1.4A](#))

1.4.86 Refuge floor

“Refuge floor” refers to a floor adequately separated from the rest of the building by fire-resisting construction. It serves as an area where evacuees can temporarily take refuge for buildings with long vertical evacuation routes to the building’s external space.

1.4.87 Relevant boundary

“Relevant boundary” refers to the lot boundary in relation to a building’s external wall or compartment. For the purpose of unprotected openings setback calculation, it may also be the notional boundary.

1.4.88 Remoteness of exits

“Remoteness of exits” refers to exits which are remotely located from each other, arranged and constructed to minimise the possibility that more than one would be rendered unusable during a fire, or other emergency conditions.

1.4.89 Roof light

“Roof light” refers to any elements in a roof intended to admit daylight.

1.4.90 Room

“Room” refers to an enclosed space bounded by walls that is not an enclosed circulation space or protected shaft at most 750mm in depth.

1.4.91 Singapore Civil Defence Force (SCDF)

“Singapore Civil Defence Force” refers to the Commissioner of Singapore Civil Defence Force and includes officers authorised by him generally or specifically to exercise the powers, functions and duties conferred by the Fire Safety Act.

1.4.92 Separated part (of a building)

“Separated part” refers to a form of compartmentation from another part of the same building by a compartment wall which runs full height of the part and is in one continuous plane.

1.4.93 Separating wall

“Separating wall” refers to a wall used to divide or portion adjoining buildings under different ownership.

1.4.94 Setback distance

“Setback distance” refers to the distance between a building and its relevant boundary, which is meant for the purpose of preventing fire spread between buildings/ properties.

1.4.95 Single point emergency lighting

“Single point emergency lighting” refers to an emergency lighting system employing self-contained emergency luminaires

1.4.96 Smoke-check door

“Smoke-check door” refers to a door or set of doors placed in an internal corridor to restrict the spread of smoke by reducing draft.

1.4.97 Smoke-stop lobby

“Smoke-stop lobby” refers to a lobby located at the entrance of an exit staircase. It is designed to help to prevent or minimise the entry of smoke into the staircase.

1.4.98 Storey

“Storey” refers to any floor or part thereof, including platforms, mezzanines, attic levels and M&E floors.

1.4.99 Super high-rise residential building

“Super high-rise residential building” refers to a residential building with more than 40 storeys/levels.

1.4.100 Supervisory care facility

“Supervisory care facility” is a building or part thereof, used for the housing, on a 24-hr basis, of mental health patients who may be capable of self-preservation but require

supervision and are receiving therapy, training or other health-related care and for whom there may be security measures not under their control.

1.4.101 Tenancy unit

“Tenancy unit” refers to an individual unit or subdivided unit within a building or a compartment, and which is managed by a different operator registered with the authority having jurisdiction.

1.4.102 Thermoplastics

“Thermoplastic” refers to a class of plastic materials that is capable of being repeatedly softened by heating and hardened by cooling. A material can be considered as thermoplastic if it is a synthetic polymeric material which has a softening point below 200°C when tested to BS EN ISO 306:2004 method A120 Plastics – Thermoplastic materials – Determination of Vicat softening temperature.

1.4.103 Thermosetting plastic

“Thermosetting plastic” refers to a class of plastic materials that will undergo a chemical reaction by the application of heat, pressure, catalysts, etc., leading to a relatively infusible, non-reversible state.

1.4.104 Toxin

“Toxin” refers to the toxins stipulated in the Fifth Schedule of the Biological Agents and Toxins Act.

1.4.105 Travel distance

“Travel distance” refers to the distance required to be traversed from the most remote point in any room or space to the edge of a door opening, directly to:

- a. an exit staircase, or
- b. an exit passageway, or
- c. an open external space,

unless otherwise permitted under this Code as in the case of residential apartments, maisonettes and exits to areas of refuge.

1.4.106 Two-way travel

“Two-way travel” refers to a situation where occupants within a space have the choice of more than one route/direction from a splitting point to reach multiple exits.

1.4.107 Unmanned building

An “unmanned building” refers to a building which is not manned by operation or security personnel after office or operating hours.

1.4.108 Unprotected area

“Unprotected area”, in relation to a side or external wall of a building, refers to:

- a. a window, door or other opening;
- b. any part of the external wall which has less than the relevant fire resistance; and
- c. any part of the external wall which has combustible material more than 1mm thick attached or applied to its external face, whether for finishes or any other purpose.

1.4.109 Vertical exit

“Vertical exit” refers to an exit staircase or exit ramp which serves as a required exit from one or more storeys above or below ground level.

1.4.110 Wall surface

“Wall surface”, in the context of internal surfaces, refers to the surface of glazing, and any part of the ceiling sloping at an angle of 70° or more to the horizontal. It does not include:

- a. door frames and unglazed parts of doors, or
- b. window frames and frames in which glazing is fitted, or
- c. architraves, cover moulds, picture rails, skirtings and similar narrow members,
or
- d. fitted furniture.

1.4.111 Workers' dormitories

“Workers' dormitories” refers to buildings or spaces in buildings where group sleeping accommodation is provided for workers under joint occupancy and single management, without cooking equipment in any room or unit of a dormitory.

TABLE 1.2A : CODES & STANDARDS		
Name	Description	Remarks
SINGAPORE STANDARDS		
SS CP 5	CoP for Wiring of Electrical Equipment of Buildings	
SS CP 10	CoP for Installation and Servicing of Electrical Fire Alarm System	
SS CP 52	CoP for Automatic Fire Sprinkler System	
SS 99	Specifications for Welded Low Carbon Steel Cylinders for Storage and Transportation of Low-Pressure Liquefiable Gases	
SS 232 Pt 1 to 6	Portable Fire Extinguishers	Replaced by SS EN 3 - 7 to 10
SS 233	Specifications for Flexible Rubber Tubing, Rubber Hose and Rubber Hose Assemblies for Use in LPG Vapour Phase Installations	
SS 254	Electrical Apparatus for Explosive Gas Atmospheres	Replaced by IEC 60079
SS 263 Pt 2	Luminaires - Particular Requirements for Luminaires for Emergency Lighting	Replaced by SS IEC 60598-2-22
SS 281	Specifications for Pressure Regulators for LPG	
SS 286	Caution Labelling for Hazardous Substances	Replaced by SS 586
SS 294	Specifications for Valves for Use with Domestic and Industrial LPG Cylinders	
SS 299	Fire Resistant Cables	
SS 332	Specification for Fire Door	
SS 333	Specification for Fire Dampers	
SS 489	Specification for Fire Shutters	
SS 508	Graphical Symbols - Safety Colours & Safety Signs	Formerly SS 217 & SS 364
Pt 1	Design Principles for Safety Signs & Safety Markings	
Pt 2	Design Principles for Product Safety Labels	
SS 532	CoP for the Storage of Flammable Liquids	Formerly CP 40
SS 535	CoP for Installation, Operation, Maintenance, Performance and Constructional Requirements of Mains Failure Standby Generating Systems	Formerly CP 31
SS 546	CoP for Emergency Voice Communication Systems in Buildings	Formerly CP 25
SS 550	CoP for Installation, Operation and Maintenance of Electric Passenger and Goods Lifts	Formerly CP 2
SS 551	CoP for Earthing	Formerly CP 16
SS 563	CoP for the Design, Installation & Maintenance of Emergency Lighting and Power Supply Systems in Building	Formerly CP 19
Pt 1	Emergency lighting	
Pt 2	Installation Requirements and Maintenance Procedures	
SS 572	CoP for the Use of Timber in Buildings	Formerly CP 1
SS 575	CoP for Fire Hydrant, Rising Mains and Hose Reel System	Formerly CP 29
SS 578	CoP for Use and Maintenance of Portable Fire Extinguishers	Formerly CP 55

TABLE 1.2A : CODES & STANDARDS		
Name	Description	Remarks
SS 586	Specification for Hazard Communication for Hazardous Chemicals and Dangerous Goods	Replaces SS 286
SS 608	CoP for Gas Installation	Formerly CP 51
SS EN 3-7	Portable Fire Extinguishers - Part 7 : Characteristics, performance requirements and test methods	Replaces SS 232 Pt 1 to 6
SS EN 3-8	Portable Fire Extinguishers - Part 8 : Additional requirements to SS EN 3-7 for the construction, resistance to pressure and mechanical tests for extinguishers with a maximum allowable pressure equal to or lower than 30 bar	Replaces SS 232 Pt 1 to 6
SS EN 3-9	Portable Fire Extinguishers - Part 9 : Additional requirements to SS EN 3-7 for pressure resistance if CO ₂ extinguishers	
SS EN 3-10	Portable Fire Extinguishers - Part 10 : Provisions for evaluating the conformity of a portable fire extinguisher to SS EN 3-7	
AMERICAN STANDARDS		
ASTM D635	Standard Test Method for Rate of Burning and/or Extent & Time of Burning of Plastics in a Horizontal Position	
ASTM E108	Standard Test Methods for Fire Tests of Roof Coverings	
ASTM E119	Standard Test Methods for Fire Tests of Building Construction & Materials	
NFPA 16	Standard for the Installation of Foam-Water Sprinkler and Foam-Water Spray Systems	Formerly NFPA 16A
NFPA 30	Flammable & Combustible Liquids Code	
NFPA 33	Standard for Spray Application Using Flammable or Combustible Materials	
NFPA 45	Standard on Fire Protection for Laboratories Using Chemicals	
NFPA 54	National Fuel Gas Code	
NFPA 55	Compressed Gases and Cryogenic Fluids Code	
NFPA 58	Liquefied Petroleum Gas Code	
NFPA 251	Standard Methods of Tests of Fire Resistance of Building Construction & Materials	
NFPA 262	Standard Methods of Tests for Flame Travel and Smoke of Wires and Cables for Use in Air-Handling Spaces	
NFPA 400	Hazardous Materials Code	Replaced by NFPA 400
NFPA 430	Code for the Storage of Liquids & Solid Oxidizers	
NFPA 432	Code for the Storage of Organic Peroxide Formulations	
NFPA 495	Explosive Materials Code	
NFPA 502	Standard for Road Tunnels, Bridges and other Limited Access Highways	
NFPA 750	Standard on Water Mist Fire Protection Systems	
UL 132	Standard for Safety Relief Valves for Anhydrous Ammonia and LP-Gas	
UL 144	Standard for LP-Gas Regulators	

TABLE 1.2A : CODES & STANDARDS		
Name	Description	Remarks
UL 300	Standard for Fire Testing of Fire Extinguishing Systems for Protection of Commercial Cooking Equipment	
AUSTRALIAN STANDARDS		
AS 1530	Methods for Fire Tests on Building Materials, Components & Structures	
Pt 4	Fire-resistance Test of Elements of Construction	
AS 2208	Safety Glazing Materials in Buildings	
AS 2714	The Storage & Handling of Organic Peroxides	
AS 2941	Fixed Fire Protection Installations - Pumpset Systems	
AS 4391	Smoke Management Systems - Hot Smoke Test	
AS 4326	The Storage & Handling of Oxidizing Agents	
AS 4587	Water Mist Fire Protection Systems - System Design, Installation and Commissioning	
BRITISH STANDARDS		
BR 186	Design Principles for Smoke Ventilation in Enclosed Shopping Centres	Published by Fire Research Station, Building Research Establishment, Borehamwood, Herts WD62BL
BR 258	Design Approaches for Smoke Control in Atrium Buildings	
BR 368	Design Methodologies for Smoke and Heat Exhaust Ventilation	Published by Construction Research Communications Ltd by permission of Building Research Establishment Ltd
BS 476	Fire Tests on Building Materials and Structures	
Pt 4	Non-Combustibility Test for Materials	
Pt 5	Method of Test for Ignitability	
Pt 6	Method of Test for Fire Propagation for Products	
Pt 7	Method of Test to Determine the Classification of the Surface Spread of Flame of Products	
Pt 11	Method for Assessing the Heat Emission from Building Materials	
Pt 20	Method for Determination of the Fire Resistance of Elements of Construction (General Principles)	
Pt 21	Methods for Determination of the Fire Resistance of Load-Bearing Elements of Construction	
Pt 22	Method for Determination of the Fire Resistance of Non-Load-Bearing Elements of Construction	
Pt 23	Methods for Determination of the Contribution of Components to the Fire Resistance of a Structure	
Pt 24	Method for Determination of the Fire Resistance of Ventilation Ducts	
BS 1230 Pt 1	Specification for Plasterboard Excluding Materials Submitted to Secondary Operations	Replaced by BS EN 520

TABLE 1.2A : CODES & STANDARDS		
Name	Description	Remarks
BS 2594	Specification for Carbon Steel Welded Horizontal Cylindrical Storage Tanks	Withdrawn
BS 3016	Specifications for Pressure Regulators for LPG	Withdrawn
BS 4514	Specification for Unplasticized PVC Soil and Ventilating Pipes of 82.4mm Minimum Mean Outside Diameter, and Fittings and Accessories of 82.4mm and of Other Sizes	
BS 5041	Fire Hydrant Systems Equipment	
Pt 1	Specification for Landing Valves for Wet Risers	
Pt 3	Specification for Inlet Breechings for Dry Riser Inlets	
BS 5234	Partitions (including matching linings)	
Pt 2	Specification for Performance Requirements for Strength and Robustness including Methods of Test	
BS 5345	Selection, Installation and Maintenance of Electrical Apparatus for Use in Potentially Explosive Atmosphere (Other than Mining Applications or Explosive Processing and Manufacturing)	Replaced by BS EN 60079-14
Pt 1	General Recommendations	
Pt 3	Installation and Maintenance Requirements for Electrical Apparatus with Type of Protection 'd'. Flameproof Enclosure	
BS 5499	Fire Safety Signs, Notices and Graphic Symbols	
Pt 2	Specification for Self-Luminous Fire Safety Signs	Withdrawn
BS 5588	Fire Precautions in the Design, Construction and Use of Buildings	
Pt 5	CoP for Firefighting Stairways and Lifts	Withdrawn
BS 5852	Methods of Test for Assessment of the Ignitability of Upholstered Seating by Smouldering and Flaming Ignition Source	
BS 6206	Specification for Impact Performance Requirements for Flat Safety Glass and Safety Plastics for Use in Buildings	
BS 6391	Specification for Non-Percolating Layflat Delivery Hoses and Hose Assemblies for Fire Fighting Purposes	
BS 7346	Components for Smoke and Heat Control Systems	
Pt 2	Specification for Powered Smoke and Heat Exhaust Ventilators	Replaced by BS EN 12101-3
Pt 3	Specification for Smoke Curtains	Replaced by BS EN 12101-1
Pt 7	CoP on Functional Recommendations and Calculation Methods for Smoke and Heat Control Systems for Covered Car Parks	
BS 8202	Coatings for Fire Protection of Building Elements	
Pt 2	CoP for the Use of Intumescent Coating Systems to Metallic Substrates for Providing Fire Resistance	
BS EN 54-2	Fire Detection and Alarm Systems - Control and Indicating Equipment	
BS EN 54-4	Fire Detection and Alarm Systems - Power Supply Equipment	
BS EN 520	Gypsum Plasterboards. Definitions, Requirements and Test Methods	Replaces BS 1230 Pt 1

TABLE 1.2A : CODES & STANDARDS		
Name	Description	Remarks
BS EN 12101-1	Smoke & Heat Control Systems - Specification for Smoke Barriers	Replaces BS 7346 Pt 3
BS EN 12101-3	Smoke & Heat Control Systems - Specification for Powered Smoke & Heat Control Ventilators (Fans)	Replaces BS 7346 Pt 2
BS EN 13501-1	Fire Test to Building Materials - Classification	
BS EN 50054	Electrical Apparatus for the Detection and Measurement of Combustible Gases. - General Requirements and Test Methods	
BS EN 50057	Electrical Apparatus for the Detection and Measurement of Combustible Gases. - Performance Requirements for Group II Apparatus Indicating up to 100% Lower Explosive Limit	
BS EN 50272-2	Safety Requirements for Secondary Batteries and Battery Installations. Stationary Batteries	Withdrawn
BS EN 50272-3	Safety Requirements for Secondary Batteries and Battery Installations. - Traction Batteries	Withdrawn
BS EN 60079-14	Explosive Atmosphere. Electrical Installations Design, Selection and Erection	Replaces BS 5345 Pt 1 & 3
BS EN IEC 62485-2	Safety Requirements for Secondary Batteries and Battery Installations. - Stationary Batteries	Replaces BS EN 50272-2
BS EN IEC 62485-3	Safety Requirements for Secondary Batteries and Battery Installations. - Traction Batteries	Replaces BS EN 50272-3
EUROPEAN STANDARDS		
EN 81-58	Safety Rules for the Construction and Installation of Lifts. Examination and Tests. Part 58 - Landing Doors Fire Resistance Test	
EN 671-1	Fixed Firefighting Systems. Hose Systems. Hose Reels with Semi-Rigid Hose	
EN 13823	Reaction to Fire Tests for Building Products - Building Products excluding Floorings exposed to the Thermal Attack by a Single Burning Item	
EN ISO 1182	Reaction to Fire Tests for Products - Non-Combustibility Test	
EN ISO 1716	Reaction to Fire Tests for Building Products - Determination of the Gross Heat of Combustion (Calorific Value)	
EN ISO 11925-2	Reaction to Fire Tests - Ignitability of Products subjected to Direct Impingement of Flame - Part 2 : Single Flame Source Test	
IEC STANDARDS		
IEC 60079	Explosive Atmospheres	
ISO STANDARDS		
ISO 834	Fire resistance Tests - Elements of Building Construction	
ISO 1896	Thermal Insulating Asbestos Boards	
ISO 5149	Refrigerating Systems and Heat Pumps - Safety and Environment Requirements	

TABLE 1.3A : ABBREVIATIONS	
Abbreviation	Definition
ACMV	Air-Conditioning & Mechanical Ventilation
AFA	Accessible Floor Area
ANSI	American National Standards Institute
AS	Australian Standard
ASHRAE	American Society of Heating, Refrigerating & Air-conditioning Engineers
ASTM	American Society for Testing and Materials
BRE	Building Research Establishment
BS	British Standard
BSL	Bio-Safety Level
CoC	Certificate of Conformity
CoP	Code of Practice
Cl.	Clause
CERT	Company Emergency Response Team
DIN	German Institute for Standardization
DoC	Declaration of Compliance
EC	Exit Capacity
EN	European Standard
FAMCP	Fully Automated Mechanised Car Park
FCC	Fire Command Centre
FM	Factory Mutual
FMRC	Factory Mutual Research Corporation
FSC	Fire Safety Certificate
HFAD	Home Fire Alarm Device
IEC	International Electrotechnical Commission
ISO	International Organisation For Standardisation
LPG	Liquid Petroleum Gas
MAQ	Maximum Allowable Quantity
MCST	Management Corporation Strata Title
MRA	Mutual Recognition Arrangement
MSDS	Material Safety Data Sheet
MV	Mechanical Ventilation
NFPA	National Fire Protection Association
NoA	Notice of Approval
NZS	New Zealand Standard
ODA	Outdoor Display Area
OL	Occupant Load
ORA	Outdoor Refreshment Area

TABLE 1.3A : ABBREVIATIONS	
Abbreviation	Definition
PG	Purpose Group
PLS	Product Listing Scheme
Pt	Part
PWDs	Persons With Disabilities
QP	Qualified Person
RI	Registered Inspector
SAC	Singapore Accreditation Council
SCDF	Singapore Civil Defence Force
SS	Singapore Standard
SS EN	Singapore Standard implementation of a European Standard
TFP	Temporary Fire Permit
UL	Underwriters Laboratories
VIFDS	Video Image Fire Detection System
WHO	World Health Organisation

TABLE 1.4A - DESIGNATION OF PURPOSE GROUPS		
Purpose Group (PG)	Descriptive Title	Purpose for which building or part of the building is used or intended to be used
I	Small residential	Residential dwelling house, such as:
		<ul style="list-style-type: none"> • bungalow • detached house • semi-detached house • terrace house
II	Other residential	Accommodation for residential purposes other than any premises comprised in PG I, such as:
		<ul style="list-style-type: none"> • apartment • cluster housing • condominium • flat • maisonette • town house
III	Institutional	Establishments used for treatment, care or maintenance of persons suffering from disabilities, such as:
		<ul style="list-style-type: none"> • community hospital • convalescent home • home for intellectually disabled • home for the aged • home for the spastic • hospice • hospital • psychiatric hospital • nursing home
		Establishments used for care or maintenance of young/dependent persons, such as:
		<ul style="list-style-type: none"> • children's home • correction centre • daycare centre • detention centre • dialysis centre • infant-care centre • rehabilitation centre • school for the spastic • senior activity centre • orphanage
		Establishments used for educational/training purposes, such as:
		<ul style="list-style-type: none"> • college • commercial/private school • enrichment centre • kindergarten/nursery • military camp • polytechnic • public school • tuition centre • university • vocational institution
		Establishments used for staff/worker lodging purposes, such as:
<ul style="list-style-type: none"> • staff quarter • wardens' accommodation • workers' dormitory 		
IV	Office	Premises used for the purposes of administration and clerical work, or as premises occupied with an office for the purposes of the activities therein carried on, such as:
		<ul style="list-style-type: none"> • banking • insurance • publisher • stock broker • telephone/telegraph operating

TABLE 1.4A - DESIGNATION OF PURPOSE GROUPS		
Purpose Group (PG)	Descriptive Title	Purpose for which building or part of the building is used or intended to be used
V	Shop	Premises used for the following purposes (and/or any other similar trades or businesses):
		<ul style="list-style-type: none"> • beauty salon • book store • boutique • confectionary outlet • departmental store • drugstore • gift shop • hairdressing salon • jewellery shop • laundry • outpatient clinic • pawnshop <ul style="list-style-type: none"> • pet shop/clinic • polyclinic • provisional shop • shopping arcade • shopping centre • show flat • showrooms for sale of goods • supermarket • take-away F&B outlet/kiosk • ticketing agency • travel agency
VI	Factory	Premises with manufacturing, processing, servicing or testing activities, such as:
		<ul style="list-style-type: none"> • aircraft hangar • chemicals • consumable products • data/server centre • electrical switching/transmitting • fireworks • food products • glassware • highly combustible substances • highly flammable products • incineration • metalwork <ul style="list-style-type: none"> • oil refinery • pharmaceutical • power generation • recycling • rubber • ship building • telecommunication exchange • vehicle repair/servicing • wafer • waste treatment/pumping • water treatment/pumping • woodwork
VII	Place of public resort	Premises used for public accommodation purpose, such as:
		<ul style="list-style-type: none"> • backpacker hotel • boarding house • hotel <ul style="list-style-type: none"> • holiday resort • serviced apartment • student hostel
		Premises used for educational purpose, such as:
		<ul style="list-style-type: none"> • auditorium • convention centre • exhibition centre <ul style="list-style-type: none"> • museum • public art gallery • public library
		Premises used for social purpose such as:
<ul style="list-style-type: none"> • community centre <ul style="list-style-type: none"> • private club 		

TABLE 1.4A - DESIGNATION OF PURPOSE GROUPS			
Purpose Group (PG)	Descriptive Title	Purpose for which building or part of the building is used or intended to be used	
VII	Place of public resort	Premises used for entertainment purpose, such as:	
		<ul style="list-style-type: none"> • casino • cinema • concert hall • discotheque 	<ul style="list-style-type: none"> • internet gaming centre • karaoke lounge • night club • theatre
		Premises used for religious purpose, such as:	
		<ul style="list-style-type: none"> • church • mosque 	<ul style="list-style-type: none"> • temple
		Premises used for body treatment purpose, such as:	
		<ul style="list-style-type: none"> • body massage • foot reflexology 	<ul style="list-style-type: none"> • gymnasium • Spa
		Premises used for recreational purpose, such as:	
		<ul style="list-style-type: none"> • amusement centre • billiard/snooker centre • bowling centre 	<ul style="list-style-type: none"> • public sport complex • public swimming complex • stadium
		Premises used for F&B purpose, such as:	
		<ul style="list-style-type: none"> • cafeteria • canteen • coffee shop • eating house • fast food outlet 	<ul style="list-style-type: none"> • food court • hawker centre • Pub/bar • restaurant
Premises used for transportation purpose, such as:			
<ul style="list-style-type: none"> • airport terminal • bus terminal 	<ul style="list-style-type: none"> • ferry terminal • train station 		
VIII	Storage	Premises used for the purposes of storing, depositing or parking of goods, materials and/or vehicles, such as:	
		<ul style="list-style-type: none"> • coldroom • godown • store 	<ul style="list-style-type: none"> • vehicle park • warehouse

TABLE 1.4B : OCCUPANT LOAD FACTORS

FUNCTIONAL SPACE	FACTOR (m ² /person)	REMARKS
Amusement park	1	excluding machine areas
Apartment, residential	15	calculated on habitable areas
Area of refuge		
ambulatory healthcare centre	1.4	
custodian care facility	1.4	
hospital	2.8	
hospital	0.56	for area of refuge without patient accommodation
nursing home	2.8	
nursing home	0.56	for area of refuge without patient accommodation
supervisory care facility	0.56	
Archive room		
reading area	5	
stack area	10	
Atrium floor	3	
Audio visual area	3	
Auditorium/theatre	1.5	for assembly occupancy, it can be based on fixed seating for purpose of computing occupant load
Audio visual control room		
theatres/cinemas/concert halls	5	
others	5	
Backpacker hotel	3	accessible floor area of each room (including living area, toilet, etc.). Max. 20 persons per room
Ball room	1.5	
Banking hall	3	
Bar/pub	1	accessible floor area
Bath room	---	non-simultaneous
Bazaar	5	
Billiards room	5	
Book/general storage	30	
Bowling alley	1	excluding bowling lanes
Business centre/office	10	
Cafeteria	1.5	
Canteen	1.5	including staff canteen
Car parking area	30	
Changing room	---	non-simultaneous

TABLE 1.4B : OCCUPANT LOAD FACTORS		
FUNCTIONAL SPACE	FACTOR (m ² /person)	REMARKS
Children playground	5	with playground equipment
Choir gallery	1.5	
Classroom	1.5	
Computer classroom	1.5	
Club room	1.5	
Concourse	3	
Conference room	1.5	
Consultant room	5	
Common room	1.5	
Computer room	5	
Corridor	---	non-simultaneous
Crematoria	1.5	
Dance studio	5	
Department store	5	
Deposit/strong room	30	
Design studio	5	
Detention room	3	
Dining area		
Hawker centre	1.5	
Fast food outlet	1	
others	1.5	
Discotheque	1	accessible floor area (including dine & dance area)
Dormitory	3	bedroom area only
Examination room	5	
Exhibition area	1.5	
Fast food outlet	1	
Filing room/store	10	
Foyer		
bus terminal	1.5	
others	3	
Fitness club/centre	5	
Function room	1.5	
General storage	30	
Goods storage	30	
Grandstand / seating area	1.5	
Guestroom / accommodation unit	15	accessible floor area of each room (including living area, toilet, etc.). Min. 2 persons per room

TABLE 1.4B : OCCUPANT LOAD FACTORS

FUNCTIONAL SPACE	FACTOR (m ² /person)	REMARKS
Gymnasium	3.5	
Health club/centre	5	
Hobby room	1.5	
Housekeeping	10	
Indoor games room	1.5	
Indoor sport hall		
school with multi-purpose hall	3	
school without multi-purpose hall	1	
others	3	
Karaoke lounge	1.5	accessible floor area of the lounge (including dine & dance areas)
Kitchen/service area	10	
Laboratory		
healthcare occupancy	20	
schools/colleges/tertiary institutions	5	
others	5	
Laundry		
with machine operation	15	
others	10	
Lecture room	1.5	
Library room		
stack area	10	
reading area	5	
others	5	
Lighting control room		
theatres/cinemas/concert halls	5	
others	5	
Loading/unloading area	4 per bay	
Lobby	---	non-simultaneous
Locker room	---	non-simultaneous
Lounge	2.5	
Machine/printing room	10	
Maisonettes, residential	15	calculated on accessible floor areas
Mechanical plant room	30	
Meeting room	1.5	
Mortuary	30	

TABLE 1.4B : OCCUPANT LOAD FACTORS		
FUNCTIONAL SPACE	FACTOR (m ² /person)	REMARKS
Multi-purpose hall / room school/colleges others	1	
	1.5	
Multi-purpose sports hall public sport complex public swimming complex stadium others	3	
	3	
	3	
	3	
Night club	1.5	accessible floor area (including dine & dance area)
Nursing station	10	
Office Admin/general director/manager room drafting room/area	10	
	15	
	5	
Operation theatre	7.5	
Orchestral pit	1.5	
Out-patient waiting area	1.5	
Packing/distribution area	10	
Pantry	---	non-simultaneous
Passenger arrival / departure areas bus terminal others	1.5	
	3	
Patient accommodation intensive care room ward	20	
	10	max 2 beds
	10	
Pedestrian linkway with commercial activities without commercial activities	2	aboveground or underground
	---	non-simultaneous
Pharmacy staff area public waiting area	10	
	2	
Prayer hall/gallery	1.5	
Pre-function room	---	non-simultaneous
Production area	10	automated or non-automated
Projection room theatre/cinema/concert hall others	5	
	5	

TABLE 1.4B : OCCUPANT LOAD FACTORS

FUNCTIONAL SPACE	FACTOR (m ² /person)	REMARKS
Promotion area	1.5	
Pub		
place behind counter	10	calculated on accessible floor area
other areas	1	
Reading room		
Reception area	3	
Recreation room	1.5	
Refreshment area	1.5	
Restroom	---	non-simultaneous
Restaurant	1.5	
Roof	---	access for maintenance only
Roof garden / roof terrace, private	---	non-simultaneous part of individual residential unit
Roof garden / roof terrace, public		
health/exercise corner	5	with exercise equipment
planter box <300mm high	1.5	
planter box =>300mm & <=500mm	---	covered fully with trees/shrubs
planter box =>300mm & <=500mm	1.5	not covered fully with trees/shrubs
planter box >500mm	---	without step/ramp access
sunken/elevated water feature <300mm in depth/height	3	permanent or fixed structure
sunken/elevated water feature =>300mm in depth/height	---	permanent or fixed structure
sunken planting area	3	
other areas	1.5	
Seating gallery	1.5	or by number of fixed seating
Seminar room	1.5	
Serviced apartment	15	per unit
Service area	10	
Shop	5	
Showroom	5	
Sick room	---	non-simultaneous
Skating rink		
rink area	3	
spectator area	1.5	
Sleeping quarter	3	
Snack bar	1.5	
Society room	1.5	

TABLE 1.4B : OCCUPANT LOAD FACTORS		
FUNCTIONAL SPACE	FACTOR (m ² /person)	REMARKS
Spa	5	include areas for weight training, aerobics, massage, sauna/steam bath and whirlpools
Squash court	2 per court	
Staff office	10	
Storage area	30	
Staff canteen	1.5	
Staff lounge	3	
Staff quarter		
religious buildings	15	
nursing home	5	
Stage, back	3	
Stage, front		
schools/colleges/tertiary institutions	3	
theatres/cinemas/concert halls	---	non-simultaneous
Storage / store room	30	
Swimming pool		
condominium/apartment	5	
hotel	---	
private club	---	
public sports complex	2.5	
public swimming complex	2.5	
serviced apartment	---	
Swimming pool deck		
condominium/apartment	10	
hotel	10	
private club	10	
public sports complex	5	
public swimming complex	5	
serviced apartment	10	
Student bedroom	15	<ul style="list-style-type: none"> including other areas such as attached living area or toilet min. 2 persons per room
Supermarket	5	
Surgical viewing gallery	3	
Therapy centre	10	
Ticketing office	10	

TABLE 1.4B : OCCUPANT LOAD FACTORS		
FUNCTIONAL SPACE	FACTOR (m ² /person)	REMARKS
Toilet	---	non-simultaneous
Trading floor	2	
Trading gallery	1.5	
Training area		
public sports complex	3	
public swimming complex	3	
stadium	3	
others	3	
Treatment room	5	
Viewing gallery	1.5	
Visitors lounge	3	
Waiting area	3	
Warden's accommodation	15	
Workshop	5	

CHAPTER

02

MEANS OF ESCAPE

**CHAPTER
2****MEANS OF ESCAPE****2.1 GENERAL**

The provisions of this chapter shall serve to express the intentions for determining the design, construction, protection, location, arrangement and maintenance of exit facilities to provide safe means of escape for occupants from all buildings hereafter erected, altered or changed in occupancy. Areas which are designated as means of escape, such as exit staircase, fire lift lobby, smoke-stop lobby, exit passageway, escape corridor shall not be turned into other usage.

2.2 DETERMINATION OF EXIT REQUIREMENTS**2.2.1 General**

The determination of exit requirements for a building shall be based upon the type of use or occupancy of the building, the occupant load, the floor area, the travel distance to an exit and the capacity of exits as provided in [Table 2.2A](#) and herein. Every storey of a building shall be provided with exit facilities for its occupant load. Vertical exits provided from any storey above ground level may serve simultaneously all storeys above the ground level. Vertical exits provided from any storey below ground level may serve all storeys below ground level, subject to the provisions of [Cl.2.3.5](#) which prohibit basement staircases being continuous with exit staircases serving the upper storeys, unless otherwise allowed by the SCDF.

2.2.2 Mixed occupancy

Where different parts of a building or storey of a building are designed for different types of occupancies or used for different purposes at the same time, the exit requirements of the entire building or storey of the building shall be determined on the basis of that type of occupancy or usage having the strictest exit requirements or the exit requirements for each building section shall be determined separately.

2.2.3 Multiple occupancy or use

Where a building or storey of a building or a part of a building is used for multiple purposes involving different activities at different times, that purpose or use involving the greatest number of occupants shall form the basis for determining the exit requirements.

2.2.4 Non-simultaneous occupancy

The floor areas of toilets, locker rooms, storage rooms, lobbies, corridors and similar rooms and spaces that serve other rooms and spaces on the same storey but are not occupied at the same time as such other rooms or spaces, can be omitted from the occupant load calculations of that storey of the building on which they are located.

2.2.5 Capacity of exits and exit facilities

- a. The capacity of exits, exit staircases, exit passageways, corridors, exit doors and other exit facilities shall be measured in units of half a metre's width. The number of persons per unit of width shall be determined by the type of occupancy and type of exit as listed under [Table 2.2A](#). In the determination of each exit width, fractions of a unit width less than 250mm shall not be factored in the measurement. Where 250mm or more are added to one or more full units, half of a unit of width shall be factored in.
- b. Where a room or space is required to be provided with two exits, each exit shall be of sufficient width to accommodate not less than half the total occupant load.

2.2.6 Determination of travel distance

The maximum travel distance for the respective types of occupancies shall be not greater than as laid down in [Table 2.2A](#) and read in conjunction with all of the following:

- a. In the case of a floor area designed with minimum two exits, the maximum travel distance as given in [Table 2.2A](#) shall be applicable. The maximum travel distance starting from the most remote point in any occupied space to the nearest exit, shall not exceed the limits specified in [Table 2.2A](#).
- b. In a large floor area without sub-division of rooms, corridors and so forth, the travel distance can adopt the “direct distance” concept as a guide and shall not exceed two-third of the maximum travel distance permitted under [Table 2.2A](#). Where the large floor area is undergoing sub-division of rooms, corridors, etc. the maximum travel distance shall be in accordance with [Table 2.2A](#).
- c. For the purpose of this clause, the most remote point from which the travel distance is measured shall be taken as being 400mm from the enclosure walls of the room or space.
- d. In the case of a residential apartment or maisonette, the travel distance shall be determined based on the provisions under [Cl.9.2.1a.\(5\)](#).
- e. Where area of refuge is provided in lieu of required exits, travel distance shall be measured to the exit door at the corridor leading to the area of refuge.
- f. Where permitted under [Cl.2.3.3](#) for exit staircases to be entered without the provision of an exit door, the travel distance shall be measured to a position where the exit door would be installed if otherwise required.
- g. **Ancillary office within other purpose groups**
Where an ancillary office is housed within a space belong to other Purpose Groups, the travel distance requirement for the ancillary office is allowed to be based on PG IV, provided:
 - (1) the ancillary office is fire compartmented from spaces belonging to the other purpose groups; and
 - (2) the ancillary office occupants shall have access to exit(s) within the

ancillary office compartment leading to direct discharge at ground level into an external space, into a protected exit staircase or internal/external exit passageway.

2.2.7 Minimum width of exit access door, exit door or other exit facilities

- a. No exit, exit staircase or other exit facilities shall be narrower than the minimum width requirement as specified under *Table 2.2A*. The minimum clear width of an exit door opening shall be not less than 850mm.
- b. Exit access doors serving a room with an occupant load of not more than two persons shall not be less than 610mm in clear width.
- c. A single leaf swing door along the means of egress shall not exceed 1.25m in clear width.

2.2.8 Maximum width of exit staircases

- a. The maximum width of exit staircases shall be not more than 2m. Where staircases exceed 2m in width, handrails shall be used to divide the staircase into sections of width not less than 1m or more than 2m.
- b. For the purpose of determining the exit capacity of a staircase that is wider than 2m that forms part of the required means of escape from any storey of the building, that part of its width in excess of 2m shall not be taken into account.

2.2.9 Measurement of width

The measurement of width referred to under *Cl.2.2.7* and *Cl.2.2.8* shall be the clear width, including the width of plinth to balustrade or parapet wall:

a. For an exit staircase

The clear width shall be measured between:

- (1) the finished surfaces of the walls, if the staircase is enclosed on both sides by walls only, or
- (2) the finished surface of the wall and the inner side of the balustrade, if the staircase has a wall on one side and a balustrade on the other side, or
- (3) the inner sides of the balustrades if the staircase has balustrades on both sides.

Note: The projection of handrail into the clear width of a staircase shall not exceed 80mm on each side of the staircase. If the projection exceeds 80mm, the clear width of the staircase shall be measured from the inner sides of the handrails.

b. For an exit door

- (1) In the case of an exit door having a single leaf door, the opening shall be measured between the edge of the door jamb and the surface of the door

when opened at an angle of 90° (See *Diagram 2.2.9b.*).

- (2) In the case of a 2-leaf exit door fitted with an approved automatic flush bolt, the clear openings shall be measured between the surface of one leaf to the other door leaf when opened at an angle of 90°.
- (3) If one of the door leaves is bolted to the door frame and/or floor by a manually operated bolt, this door leaf shall not be considered for the purpose of determining the exit capacity of the door. The opening of the other door leaf shall have a clear width of not less than 850mm, measured between the edge of the bolted door leaf and the surface of the other door leaf, when opened at an angle of 90°.
- (4) Door hardware and handrails which do not protrude more than 80mm into the clear width of exit opening can be disregarded.

2.2.10 Number of exits from rooms and spaces

There shall be at least two door openings remote from each other which lead to exits from every room or enclosed space in which the total occupant load exceeds the maximum permissible occupant load for one door as listed in the table below:

TABLE 2.2.10 - PERMISSIBLE OCCUPANT LOAD FOR ONE DOOR	
Type of Occupancy	Max. Occupant Load
High hazard	25
Patient accommodation area	50
Classrooms	50
Godowns, stores, and factories not of high hazard type	50
Assembly	50
<p><u>Note:</u></p> <ul style="list-style-type: none"> (a) The number and minimum width of exits for rooms and spaces with occupancy of more than 50 persons shall comply with provisions in Table 9.7.3a. for assembly occupancy. (b) For residential occupancy, see Cl.9.2. (c) For healthcare occupancy, see Cl.9.3.2 (d) For office/shop/factory/warehouse occupancy, see Cl.9.4, 9.5, 9.6, and 9.8 (e) For hotels, see Cl.9.7.2 (f) For assembly occupancy, see Cl.9.7.3. 	

2.2.11 Number of exit staircases or exits per storey

There shall be at least two independent exit staircases or other exits from every storey of a building, unless otherwise permitted under other subsequent provisions of the Code. For non-habitable roof, at least one exit staircase shall be provided. Where the area of non-habitable roof is large and one-way travel distance to the exit cannot be met, an additional cat/ship ladder adequately separated in accordance with [Cl.2.3.12](#) and leading to the circulation area of the floor below shall be provided. All access hatches, if provided, shall be readily accessible from the roof. Access hatch opening shall have a minimum clear width of 1m in

diameter. The travel distances (one-way and two-way) can be based on that for a sprinkler-protected building for roof areas which are open-to-sky.

2.2.12 Location of exits & access to exits

All exits and access facilities shall be required to comply with all of the following:

- a. Exits and access facilities shall be clearly visible or their locations shall be clearly indicated and shall be kept readily accessible and unobstructed at all times.
- b. Every occupant or tenant within a building or storey of a building shall have direct access to the required exit or exits without the need to pass through the spaces or rooms occupied by other occupants or tenants.
- c. When more than one exit is required from any room or space or a storey of a building, each exit shall be placed as remote as possible from the other as permitted under *Cl.2.3.12a., b., c. or d.*

2.2.13 Smoke-free approach to exit staircase

Entry at every storey level (including 1st storey) to an exit staircase serving more than four storeys above ground level shall be through any one of the following:

a. **An external exit passageway or external corridor**

The openings for natural lighting and ventilation to the corridor shall be located such that they face and are open to any of the following:

- (1) an external space complying with *Cl.2.3.11*, or
- (2) a street, service road or other public space which is open to the sky, or
- (3) an air well which opens vertically to the sky and has a minimum width of 6m and a superficial plan area of not less than 93m², except that for external corridors, it shall comply with the requirements of *Cl.2.3.10*.

b. **Smoke-stop lobby**

- (1) A smoke-stop lobby shall be separated from the adjoining areas of the building by a wall having 1-hr fire resistance.
- (2) The exit access door shall have ½-hr fire resistance fitted with automatic self-closing device conforming to the requirements of *Cl.3.9.2*.
- (3) The design of a smoke-stop lobby shall be such as not to impede movement of occupants through the escape route.
- (4) The floor area of a smoke-stop lobby shall be at least 3m² and with minimum clear width of 1.2m. If a smoke-stop lobby also serves as a fire lift lobby, the floor area shall be not smaller than 6m² and with minimum clear width of 2m.
- (5) The floor shall be graded from the lift door towards the lobby door with

a fall not exceeding 1 in 200.

- (6) A smoke-stop lobby, including fire lift lobby, which acts as buffer space for entry into the protected staircase and use by firefighters during emergency, shall be maintained as common property.

- (7) A smoke-stop lobby shall be ventilated through any of the following:

- (a) Permanent fixed ventilation openings which are located in the external wall of the lobby and have a total area of not less than 15% of the floor area of the lobby.

Each opening shall not be less than 1m² and shall abut an external space or air well, each having a minimum clear area of 93m² and minimum width of 6m and without obstruction vertically throughout the airspace for ventilation. No part of the lobby floor area shall be more than 9m away from the air well or external space.

- (b) Mechanical ventilation, except for PG II buildings, which complies with the requirements in Chapter 7.

- (c) Cross-ventilated corridor/lobby which complies with all of the following:

- (i) The corridor/lobby shall have fixed ventilation openings abutting an external space. The ventilation openings shall be located on opposite sides of the corridor/lobby at high level and shall not be less than 50% of the superficial area of the opposing external walls.

- (ii) No part of the floor area of the corridor/lobby shall be at a distance of more than 12m from the ventilation openings.

- (iii) The distance of 12m can be measured along the internal corridor via the intermediate ventilation opening to the external space, provided there is no unprotected openings in the walls along the path to the external space. The intermediate ventilation opening shall not be less than 2m in width and 1.2m in height and the width of the path to the external space shall not be less than 2m.

Note: For residential buildings of habitable height more than 24m with single exit staircase, the requirements for the cross-ventilated corridor/lobby stipulated in [Cl.9.2.1a.\(4\)\(e\)](#) shall be complied with.

c. Exception

- (1) The omission of the smoke-stop lobby required under [Cl.2.2.13b](#), leading to the exit staircase of any building exceeding four storeys is allowed under any of the following situations, provided the door opening into the exit staircases shall have 1-hr fire resistance rating and fitted with an automatic self-closing device to comply with the requirements of [Cl.3.9.2](#):

- (a) Where the internal exit staircase is provided with pressurisation up to a habitable height of 24m in compliance with the requirements of Chapter 7;
 - (b) Where an external exit staircase is constructed to comply with Cl.2.3.3b.;
 - (c) In an open-sided car park floor where cross-ventilation is provided. In this situation, the fire door to the exit staircase can be ½-hr fire-rated.
 - (d) On M&E floor of headroom not exceeding 1.5m.
- (2) The omission of a smoke-stop lobby to exit staircases shall not be allowed under any of the following situations:
- (a) Where the building exceeds four storeys and belongs to PG III or VII.
 - (b) Where the internal exit staircase, which is provided with pressurisation, exceeds the habitable height of 24m.
 - (c) Where the exit staircase is adjacent to a fire lift as required in Chapter 6.

2.2.14 Smoke-free approach to exit staircase in basement

- a. In a building comprising more than four basement storeys, the entry to exit staircases serving the basement storeys at every basement storey level shall be through smoke-stop lobbies, one of which shall be designated as a fire lift lobby. The exit staircase connecting to the fire lift lobby shall be pressurised to comply with the requirements in Chapter 7.
- b. In a building comprising two, three or four basement storeys, entry at every basement storey level to at least one of the exit staircases serving the basement storeys shall be through a smoke-stop lobby. Where only one smoke-stop lobby is provided, it shall be required to serve as a fire lift lobby.
- c. Smoke-stop lobbies in basement occupancies shall be required to comply with the relevant provisions under *Cl.2.2.13b.* and shall be mechanically ventilated to comply with the requirements in Chapter 7.

2.2.15 Area of refuge and exit reduction

When a floor area has access to area(s) of refuge in compliance with all of the following requirements in this Clause, the occupant load for which vertical exits are to be accounted for the floor area can be reduced to half when one area of refuge is provided and to one third when two or more areas of refuge are provided.

- a. An area of refuge shall be adequate in size to hold the occupant load it receives from the floor area it serves as provision for required exit, in addition to its own occupant load calculated on the basis of 0.3m² per person except for healthcare

occupancies when the occupant load shall comply with the provisions under *Cl.9.3.2b.(4)*.

- b. An area of refuge shall be provided with at least one staircase for use by the occupants to gain access to other exit staircases or the ground level directly to an external space.
- c. An area of refuge shall be entered through an external corridor and the room or space or area of refuge shall be separated from the corridor by a wall with at least 1-hr fire resistance rating.
- d. External corridors when used as entry into an area of refuge shall conform to the requirements for external exit passageway for minimum width, changes in floor level, roof protection, enclosure on the open side and provision of opening of wall between the room or space and the exit passageway.
- e. Exit doors between the room or space or area of refuge and the external corridor shall have fire resistance of at least ½-hr and be fitted with an automatic self-closing device to comply with the requirements of *Cl.3.9.2*.
- f. Every fire compartment in which exit reduction is permitted in connection with area of refuge shall have in addition to exit through the area(s) of refuge at least one exit staircase complying with *Cl.2.3.3*.

2.3 MEANS OF ESCAPE REQUIREMENTS

2.3.1 General

- a. Means of escape shall be provided for all buildings by one or more of the facilities listed herein. Access and exit facilities not specifically covered in this Code shall not be used without the approval of the SCDF. Required exits shall be kept readily accessible, and doors shall be openable and unobstructed at all times during the occupancy of the building.
- b. **Exit staircase signage**
 - (1) Exit staircases serving all buildings (except PG I) shall be provided with a signage not smaller than 300 x 300mm and be within the stairwell at each storey landing.
 - (2) The signage shall contain the following information:
 - (a) the storey number, at least 125mm in height; and
 - (b) an identification of the staircase in alphabetical and/or numeric form, at least 25mm in height.
 - (3) The letters and numbers on the sign can be of any colour that provides contrast with the background colour.
 - (4) The signage shall be located such that it is visible when the door is in the open position and also visible to any person moving up or down the

staircase.

c. Fire escape plan

A fire escape plan shall be provided for all buildings except PG I and displayed in common lobbies or lift lobbies such that they are easily viewable by the building occupants and the general public passing through these common areas. The fire escape plan shall have legible lettering and the fire escape routes made clear to the viewer. It shall clearly show the layout of the floor in the correct orientation and highlight the escape routes (in relation to viewer's location), escape corridors and exit staircases using appropriate colours, directional signs and words. Other information required on the plan are for firefighting and evacuation purposes and shall include the locations of the following:

- (1) Fire lifts;
- (2) Evacuation lifts;
- (3) PWD holding points;
- (4) Hose reels;
- (5) Fire extinguishers;
- (6) Manual alarm call points; and
- (7) Rising mains.

2.3.2 Exit passageways

a. Fire resistance

Exit passageways that serve as a means of escape or required exits from any building or storey of a building shall have the requisite fire resistance as specified under [Cl.3.3](#).

b. Internal exit passageway

An internal exit passageway which serves as required exit of a building shall comply with the following requirements:

- (1) it shall be enclosed with construction complying with the provisions of [Cl.3.3](#);
- (2) the enclosure walls shall have not more than two exit doors, excluding the final discharge door and exit staircase door, opening into the exit passageway;
- (3) exit doors opening into an exit passageway shall have fire resistance rating as required for exit doors opening into exit staircases, be fitted with automatic self-closing device and comply with the requirements of [Cl.3.9.2](#) for fire resisting doors;
- (4) the minimum width and capacity of exit passageway shall comply with the requirements as provided in [Table 2.2A](#);

- (5) changes in level along an exit passageway requiring less than two risers shall be via a ramp complying with the provisions under Cl.2.3.8; and
- (6) if the exit staircase which connects to the internal exit passageway is pressurised, the internal exit passageway shall also be pressurised to comply with the requirements in Chapter 7.

c. External exit passageway

An external exit passageway can be used as a required exit in lieu of an internal exit passageway. It shall comply with the following requirements:

- (1) any ventilation openings on the external wall between the exit passageway and the rest of the floor space shall be of non-combustible construction, fixed at a level of at least 1.8m, measured from the finished floor level of the passageway to the sill level of the openings and such ventilation openings shall be located not less than 3m from any opening of an exit staircase;
- (2) it is exempted from the limitations of a maximum of two exit doors opening into the exit passageway;
- (3) it can be roofed over provided the depth of the roofed over portion does not exceed 3m to avoid smoke logging;
- (4) it can be enclosed on the open side by only a parapet wall of not less than 1m and not more than 1.1m in height and the vertical height of the unobstructed ventilation opening measured from the parapet wall up to the top edge of the opening or eaves of overhang shall not be less than 1.2m; and
- (5) exit doors opening into an external exit passageway shall have fire resistance rating of at least ½-hr and shall be fitted with an automatic self-closing device.

d. Ventilation

- (1) All internal exit passageways shall be naturally ventilated by fixed ventilation openings in an external wall, such ventilation openings being not less than 15% of the floor area of the exit passageway.
- (2) Internal exit passageways that cannot be naturally ventilated shall be mechanically ventilated to comply with the requirements in Chapter 7.

2.3.3 Exit staircase

a. Internal exit staircase

(1) Staircase enclosure

An internal exit staircase which serves as the required exit of the building shall be enclosed with construction complying with the provisions of Cl.3.8. The enclosure walls of an internal exit staircase, excluding the final discharge, shall not have more than two exit doors

opening into the exit staircase shaft at each storey.

(2) Approached via external exit passageway or external corridor

Where an internal exit staircase is directly approached from an external exit passageway or external corridor, such enclosure between the staircase and the external exit passageway or external corridor is not required.

(3) Unprotected openings

There shall be no unprotected openings of occupancy area or combustible material/construction within 1.5m horizontally or within 3m vertically below any opening including final discharge openings located in the external walls of the internal exit staircase.

(4) Exception

(a) Single storey basement car park

Exit staircases, including exit ramps in compliance with Cl.2.3.8a. & Cl.2.3.8b., serving the single storey basement of PG II to VII buildings are not required to be protected with fire-rated enclosures, provided the travel distances in the car park measured to the exit doors at ground level comply with [Table 2.2A](#).

(b) Standalone car park

Doors to exit staircases of standalone car park buildings that are without any commercial activities or non-ancillary usage can be omitted, provided that all of the following conditions are complied with:

- (i) The car park building shall not exceed five storeys above ground. It shall not consist of any basement storey, and shall not be connected to any other building, except by open-sided covered link-way.
- (ii) At least two exit staircases shall be provided to serve every upper storey. The two staircases shall be located as remotely from one another as practicable. The exit openings to the staircases at each storey shall have a clear width of not more than 1m or less than 850mm and a clear height of not more than 2m. The staircases shall be ventilated by fixed openings in the external walls, such openings being of area not less than 10% of the floor area per floor of the staircase. Exit staircase and occupancy area shall not share the same air well or void for lighting and ventilation.
- (iii) Every storey shall be provided with cross ventilation. The building shall be open-sided having not less than 50% of the sides (front, rear and sides elevations) permanently open, with such openings being evenly distributed around the perimeter walls, excluding perimeter walls to air well, so as

to provide effective cross ventilation to all parts of the car parking decks.

- (iv) No part of the floor space shall be more than 12m from the openings on the perimeter walls of the building or air wells. Air wells where provided for this purpose shall have a superficial plan area of not less than 10m², and have a minimum dimension on plan of 2m, open vertically to the sky for its full height.
- (v) The travel distance within each car parking deck shall comply with [Table 2.2A](#). For upper storeys, the travel distance requirement shall be measured to a position where the exit door to the staircase would have been installed if otherwise required.
- (vi) The separation distance between the nearest edge of exit opening to exit staircase and the nearest edge of any vehicle parking lot shall not be less than 3m.

b. External exit staircase

- (1) An exit staircase can qualify as an external exit staircase if no part of it is recessed more than 3m from the building façade and has:
 - (a) minimum two adjacent sides abutting an external space; or
 - (b) one of its longest sides abutting the external space.
- (2) An external exit staircase can be used as required exit in-lieu of internal exit staircase provided:
 - (a) it complies with the requirements for exit staircase, and
 - (b) there is no unprotected opening, or combustible material/ construction within 3m horizontally or within 3m vertically below, or adjacent or facing it.

Exception:

In a building designed with external corridor access, the access to the external exit staircase can be by means of the open-sided external corridor adjoining the occupancy areas, subject to the following:

- (i) the external corridor shall be served by at least two exit staircases; and
- (ii) unobstructed ventilation openings shall be provided along the long side of the external corridor above the parapet or balustrade; and
- (c) its final discharge leads directly to an external space.

- (3) Fire-rated doors to the external exit staircases shall be provided unless the conditions given in C1.2.3.3a.(4) are fully complied with.

c. Discharge

- (1) All exit staircases shall discharge at ground level directly into:
- (a) an external space, or
 - (b) an open-sided external corridor with no commercial activity and is not more than 5m from the building eave line, or
 - (c) an open-to-sky corridor having minimum width of 1.2m. and two-way escape paths leading to an external space. Any unprotected openings along the corridor shall not be located lower than 1.8m from the floor level.
- (2) In a sprinkler-protected building, a maximum of 50% of the total number of exit staircase can be discharged directly to the ground level covered circulation space provided all of the following are complied with:
- (a) The discharge point of the exit staircase into the ground level circulation space shall be within sight of and with direct access to an external space.
 - (b) The maximum distance between the discharge point of an exit staircase and the external space shall not exceed 10m.
 - (c) Where there are commercial activities e.g. shops or kiosks/carts located along one side or both sides of the designated escape passageway leading to an external space, a minimum separation distance of 10m shall be maintained between the commercial activities and the designated escape passageway. The circulation space shall also be installed with engineered smoke control system. Alternatively, the commercial activities shall be fire compartmented with walls and doors of minimum 1-hr fire resistance rating.
 - (d) The clear width of the exit doors leading to an external space shall be adequate to receive the occupant load in the 1st storey circulation space and the total number of people discharging from the internal exit staircases.
- (3) In the case of a PG II residential building not fitted with an automatic sprinkler system, at least 50% of the total number of exit staircases shall discharge to an external space and the remaining exit staircase can be discharged to the ground level covered circulation space provided the following are complied with:
- (a) the ground level covered circulation space shall be free of any commercial activity;
 - (b) the discharge point into the ground level circulation space shall be

within sight of and provided with at least two alternative routes to an external space;

- (c) the maximum distance between the discharge point of an exit staircase and the external space shall not exceed 10m;
 - (d) there shall not be more than four residential units opening into the designated escape passageway at grade level into which the exit staircase discharges; and
 - (e) the discharge point of an exit staircase shall be effectively cross-ventilated such that:
 - (i) each end has at least 50% permanent openings; and
 - (ii) no part of the circulation space shall be more than 10m from the openings on the perimeter walls of the building or air well.
- (4) There shall be no unprotected openings of occupancy area or combustible material/construction within 3m from discharge point of the exit staircase (both internal and external). This distance can be reduced to 1.5m if the unprotected openings are along the same plane of the staircase exit.

d. Minimum width and capacity

The minimum width and capacity of exit staircases shall be as specified in [Table 2.2A](#), and such staircases shall comply with all of the following:

(1) Winders

Winders are not permitted in any building other than for access staircases in a residential unit and in such cases, there shall be not more than one winder per 90° turn.

(2) Treads for circular staircase

Where a circular staircase is used as an exit staircases or access staircase in PG I & II buildings, the width of treads measured at the narrower end shall be not less than 100mm in residential buildings and 125mm in other buildings and at a distance of half metre from the narrower end shall be not less than 225mm in residential buildings and 250mm in other buildings. Such staircase shall not be more than 10m in height.

(3) Landings

The minimum clear width and length of a landing, where there is a change in direction, shall not be less than the clear width of the exit staircase.

(4) Risers and treads

The height of the riser for any exit staircase shall not be more than 175mm and depth of tread shall not be less than:

- (a) 225mm within residential units and 275mm for common areas of residential buildings;
- (b) 250mm for PG VI and VIII buildings; and
- (c) 275mm for all other buildings.

(5) Headroom

The clear headroom shall be at least 2m measured from the pitch line of the exit staircase or finished floor level of the landing to the underside of any obstruction.

(6) Handrails

- (a) Every exit staircase shall have handrails on both sides. For exit staircases with only 1.25m or less in width, a handrail can be provided only at one side, i.e. the opposite side shall be either wall, parapet or grilles.
- (b) Where the width of the exit staircase exceeds 2m, handrails shall be provided in accordance with the requirements of [Cl.2.2.8](#).

(7) Ventilation

All exit staircases shall be ventilated by fixed openings in the external walls, such openings being of area not less than 10% of the floor area per floor of the staircase, or mechanically ventilated to comply with the requirements in Chapter 7. Ventilation openings fronting an air well, external recessed space or external shall be in accordance with [Table 1.4.2](#). An exit staircase and occupancy area shall not share the same air well or void for lighting and ventilation. Mechanical ventilation is not allowed for PG II, except for a staircase storey shelter.

(8) Pressurisation

In any building, except PG II, for which the habitable height exceeds 24m, any internal exit staircases without provision for natural ventilation shall be pressurised to comply with the requirements in Chapter 7. In a building comprising more than four basement storeys, the exit staircase connecting to the fire lift lobby shall be pressurised.

(9) Different modes of ventilation within a single staircase shaft

For buildings exceeding 24m in habitable height, the internal exit staircase can be naturally ventilated at its upper part and mechanically ventilated at its lower part provided this lower part does not exceed 24m in habitable height and there shall not be any intermediate staircase landing door separating the two modes of ventilation. If the lower part exceeds 24m in habitable height, this lower part shall be pressurised instead. For pressurisation of exit staircase, an intermediate staircase landing door is permitted.

2.3.4 Scissor exit staircase

Scissor exit staircase shall comply with the following:

- a. where two separate internal exit staircases are contained within the same enclosure, each exit staircase shall be separated from the other by non-combustible construction having fire resistance for a minimum period equal to that required for the enclosure;
- b. such scissor exit staircases shall comply with all applicable provisions for exit staircase;
- c. for exit door openings of scissor exit staircases, the separation distance between the two closer edges of staircase doors shall be at least 7m;
- d. where there is only one pair of scissor exit staircases, the door opening into scissor exit staircases shall be spaced at least $\frac{1}{3}$ the diagonal dimension of the area to be served in a sprinkler-protected building and $\frac{1}{2}$ the diagonal dimension in a non-sprinkler-protected building in accordance with [Cl.2.3.12](#); and
- e. the ventilation openings of each staircase shall be located on alternate storeys if such openings or windows are serving both staircases on the same wall.

2.3.5 Basement exit staircase

- a. Any exit staircase which serves a basement storey of a building, unless otherwise stated in [Cl.2.3.3a.\(4\)\(a\)](#), shall comply with all the applicable provisions for exit staircase.
- b. Such exit staircase shall not be made continuous with any other exit staircase which serves a non-basement storey of the building.

c. Separate protected shaft

Basement exit staircases which are vertically aligned with the exit staircases of non-basement storeys shall be separated from such other exit staircases by construction having fire resistance for a minimum period equal to that required for the enclosure.

d. Upper storey staircase that continues into basement

Where upper storey staircase is allowed by the SCDF to be continuous with that serving a basement which is naturally ventilated, all of the following shall be complied with:

(1) Entry at basement

The entry into the basement staircase shall be through a protected lobby, or directly from the basement occupancy area provided the door to the basement staircase is at least 1-hr fire-rated.

(2) Barrier

To prevent occupants exiting continuously from upper storeys into the

basement storey during an emergency, a physical barrier in the form of a door or gate (self-closing type) shall be provided across the staircase landing at ground level to separate the discharge route of upper storeys from the basement staircase.

(3) Smoke-stop lobby

A smoke-stop lobby shall be provided for entry into the staircase at all storeys, including basement storeys if the staircase serves more than four storeys, including basement storeys.

(4) Signage

Appropriate signage shall be provided inside the staircase enclosure to direct occupants out of the building at ground level.

2.3.6 Hardwood staircase

- a. A hardwood staircase can be used as an internal access staircase in building.
- b. Where timber staircases are used in units in PG I and II buildings, which are not under conservation, the structural elements such as the stringer supporting the treads and risers shall be constructed of non-combustible materials.

2.3.7 Spiral staircase

- a. Spiral staircases shall not serve as required exits, unless they comply with all of the following conditions. They shall:
 - (1) be external and unenclosed;
 - (2) serve only mezzanine floors, balconies, or any storey of occupant load not exceeding 25 persons;
 - (3) be constructed of non-combustible materials;
 - (4) have a tread length of at least 750mm; and
 - (5) be not more than 10m high.
- b. Spiral staircases shall not be designed as the sole means of escape for buildings under PG I and for PG II maisonettes and penthouses.

2.3.8 Exit ramp

Internal and external exit ramps can be used as exits in lieu of internal and external exit staircases subject to compliance with [Cl.2.3.3](#) and all of the following:

a. Slope

The slope of such exit ramps shall not be steeper than 1 in 10.

b. Changes in direction

Exit ramps shall be straight with changes in direction being made at level

platforms or landings only, except that exit ramps having a slope not greater than 1 in 12 at any place can be curved.

c. Platform

- (1) Level platforms or landings shall be provided at the bottom, at intermediate levels where required and at the top of all exit ramps.
- (2) Level platforms shall be provided at each door opening into or from an exit ramp.
- (3) The minimum width and length of a platform or landing shall be not less than the width of the ramp, except that on a straight run ramp, the length of the level platform or landing need not be more than 1m.

d. Guards and handrails

Exit ramps shall have walls, guards or handrails and shall comply with the applicable requirements of [Cl.2.3.3d](#) for exit staircases.

e. Surface

All exit ramps shall be provided with non-slip surface finishes.

f. Ventilation

Exit ramps shall be ventilated to comply with the requirements for ventilation of exit staircases.

g. Enclosure exemption

Exit ramps serving as means of escape to only one basement storey need not be protected by enclosure walls.

2.3.9 Exit doors and exit access doors

Exit doors and exit access doors shall comply with all of the following:

a. Door operation

Exit doors shall be capable of being opened manually, without the use of a key, tool, or special knowledge or effort for operation from the inside of the building. (Not applicable to buildings under PG I & II)

b. Fire resistance

Exit doors which are required to have fire resistance rating shall comply with the relevant provisions for fire resisting doors under [Cl.3.9.2](#).

c. Door swing

Exit doors and exit access doors shall open in the direction of exit travel in the following situations:

- (1) when leading to an area of refuge, exit and exit passageway, or
- (2) when used in an exit enclosure, including smoke-stop and fire lift lobbies

in a building, but excluding doors of individual residential units that open directly into an exit enclosure, or

- (3) when serving a high hazard area, or
- (4) when serving a room or space with more than 50 persons.

d. Exit door opening

(1) Opening into exit staircase

Exit doors opening into exit staircases and exit passageways shall not impede the egress of occupants when such doors are swung open.

(2) Opening into corridor

All doors which open into the corridor shall not hinder the movement of occupants. When such a door(s) is swung open, the corridor's clear width shall be at least half of the required clear width as stipulated under [Table 2.2A](#).

(3) Opening force

The maximum exit doors and exit access doors opening force shall be 30N at 0° and 20N at 30° opening.

e. Vision panel

The fire door to a protected staircase and smoke-stop/ fire lift lobby shall be constructed to incorporate a vision panel. The vision panel shall have a clear view size of 100mm width by 600mm height. The vision panel shall have the requisite fire resistance rating and shall not turn opaque when subject to heat. The bottom edge of the vision panel shall be located at 900mm above the finished floor level. The provision of vision panel shall not apply to fire doors of residential apartment or maisonette units.

f. Revolving doors

Revolving doors shall not be used as exit doors for required exits.

g. Exit door of residential unit

Exit door of each residential unit shall be located at not more than 500mm from the strata-title line to prevent the creation of a large entrance alcove/ corridor. In situations where the entrance alcove/corridor leads into an open-sided common corridor which meets the requirements for smoke-free approach under [Cl.9.2.1a.\(4\)\(e\)](#) & [\(f\)](#), the separation distance between the entrance alcove/corridor and the nearest exit staircase shall not be less than 3m.

h. Door located in a path of travel

- (1) Any door located in a path of travel shall be of the side-hinged or pivoted swing type. The door shall be designed and installed so that when swung open, it does not prevent full use of the opening. The minimum clear width of the door opening shall not be less than the required door clear width.

Exception

- (a) Requirement on door swing shall not apply to buildings under PG I and residential units under PG II.

- (b) Locking device

With prior consent from the SCDF, locking of exit doors is permissible at certain rooms or spaces of healthcare occupancies and detention and correctional occupancies.

- (c) Sliding doors & roller shutters

Sliding door and roller shutter as listed in *Cl.2.3.9h.(2)(a)* to (d) below are permitted to be installed across the exit access leading to exits, including the exterior door openings, except in areas stipulated under *Cl.2.3.9c.(1) and (3)*. These doors shall not form part of the fire compartment integrity.

(2) **Manually operable sliding doors/roller shutters**

- (a) Manually operable sliding doors or roller shutters shall be capable of being opened and closed manually from either side of the door. The maximum opening force for sliding doors/roller shutters shall not be more than 30N.

- (b) A manually operable sliding door or roller shutter that can remain in closed position during the period of occupation is permitted for rooms or spaces with occupant load not exceeding 50 persons. When opened, it shall not reduce the effective width/height of the doorway leading to the escape route. The sliding door or roller shutter is allowed for room or space that serves more than 50 persons provided it shall remain in the full open position during the period of occupation. A readily discernible sign with the lettering “THIS DOOR TO REMAIN OPEN WHEN THE BUILDING IS OCCUPIED” shall be permanently pasted on both sides of such a sliding door or roller shutter at a height of 1.4m from the finished floor level. The lettering shall be 25mm in height and painted in white on a red background with reflective surface.

- (c) Wicket door

A wicket door can be incorporated within a roller shutter or sliding door. The wicket door shall be of the swing type having a minimum head height of 2m and a clear width of not less than the required door clear width. The wicket door shall comply with all the requirements of an exit access door, and be clearly marked and readily visible so that the occupants can readily see where the door is. It shall be fitted only with simple fastenings that can be manually operated for ease of escape.

- (d) Sliding door with swing-out feature

A sliding door which can be swung open shall swing in the

direction of escape travel when a certain horizontal force is applied to the door. When the sliding door is converted to a swing door, it shall comply with all the requirements of an exit access door. The maximum door opening force shall be 30N at 0° and 20N at 30° opening. A readily visible sign with the lettering “IN EMERGENCY, PUSH TO OPEN” shall be affixed onto the door.

(e) Power operated sliding doors/roller shutters

Power operated automatic sliding doors/roller shutters, shall be linked to the building fire alarm system. The sliding door/roller shutter shall automatically open to the required width/height (of door opening) upon the activation of the fire alarm. The automatic sliding door/roller shutter shall also comply with all of the following:

(i) Fail-safe type

The automatic sliding doors/roller shutters shall be of the fail safe type. Should there be any fault in the electrical or sensor device, or any power failure (either mains or battery powered), these doors shall automatically open and remain in an open position until power is restored.

(ii) Manual override

A manual override mechanism (a device to trigger the immediate opening of sliding doors/roller shutters) shall be provided. The doors shall open and remain open upon activation of this device. This device shall be housed in a break glass box located beside the sliding doors or roller shutters and fixed at a height of 1.2m above the finished floor level. It shall be easily accessible, conspicuous and be free from obstructions. A readily discernible sign with the lettering “EMERGENCY DOOR RELEASE” shall be permanently displayed beside the switch. The lettering shall be of at least 15mm in height.

Exception : Powered sliding doors, roller shutters and swing doors that belong to the unit owners or tenants are not required to be linked to the building fire alarm system, provided they are designed as fail-safe type, installed with manual override, and do not form part of the building’s fire protection system, e.g. smoke control system.

i. Exit/exit access door serving spaces of mass occupation

Any exit door or exit access door serving spaces of assembly/mass occupation, namely, auditorium, concert hall, theatre, assembly hall, exhibition hall, conference hall, cinema, stadium, function hall, casino, or any other spaces with an occupant load factor of not greater than 1m²/person and occupant load greater than 50, which has to be kept shut and fastened while the building or

part of the building is occupied shall be fitted with ‘panic exit device’. The panic exit device shall operate to open the door when a pressure is applied on the bar in the direction of travel and be appropriately marked ‘Push Bar To Open’ in letters not less than 50mm high.

j. Locking of doors to exit staircase, smoke-stop lobby and fire lift lobby

One-way locking device e.g. panic bolt or thumb turn locking device is not permitted under the following situations:

- (1) for the exit door between exit staircase and fire lift lobby;
- (2) for the exit door between exit staircase and smoke-stop lobby/fire lift lobby/occupancy area on re-entry floor; and
- (3) for the exit access door between smoke-stop lobby/fire lift lobby and occupancy area on re-entry floor.

k. Access control using smart card locking device, magnetic bar and electromechanical locking device

(1) Where access control using smart card locking device, magnetic bar or electromechanical locking device are installed at fire-rated door(s) of an exit staircase and smoke-stop/fire lift lobby (see also note to Table 6.3A):

- (a) the activation of the building fire alarm or sprinkler system shall automatically unlock the door. It shall remain unlocked until the building fire alarm system has been manually reset; and
- (b) in addition, the door shall be arranged to unlock from a manual override device located within the occupancy space, 1.2m above the floor and within 1.5m of the exit door jamb. The manual override device shall be readily accessible and clearly identified by a sign that reads “Emergency Door Release”. The mechanism to unlock the door shall be fail-safe type.

(2) Access control belonging to tenanted spaces

Where access control belonging to tenanted spaces are installed with smart card locking device, magnetic bar, electromechanical locking device and the like to prevent unauthorised access, such locking mechanism shall be arranged to unlock from a manual override device in accordance with *Cl.2.3.9k.(1)(b)*. The manual override device serves as a means for occupant to get out of the occupied space during a fire emergency. Any form of staff access control facilitating daily operation shall not be considered as a substitute for manual override device. *Cl.2.3.9k.(1)(a)* is not applicable to tenanted spaces.

(3) Where doors opening into a passenger lift lobby are provided with access-control and locked after normal operation hours, the lobby shall be designed to have direct access to at least one exit staircase to prevent any occupant from being trapped in the lobby when the lifts are recalled to the 1st storey or other designated floor during fire

emergency or building power failure. Alternatively, a two-way communication system shall be available inside the lift lobby for use by trapped occupants to call for help. The two-way communication system shall be linked to the FCC and/or building control room which shall be manned 24 hours.

l. Staircase re-entry

- (1) Every exit staircase enclosure serving more than 7 storeys of a non-residential building, excluding buildings of detention and correctional occupancies, shall allow re-entry from the staircase enclosure to the interior of the building. There shall be at least one level where it is possible to re-enter into the interior of the building from the exit staircase enclosure.
- (2) The re-entry points shall be located not more than 6 storeys apart. There shall not be more than three storeys above the highest re-entry door in the building.
- (3) Where re-entry is provided from the staircase enclosure, it shall open into a common corridor that is connected directly to at least one other exit staircase.
- (4) Staircase doors permitting re-entry into the building, shall be identified with a signage “Re-entry door” of at least 50mm lettering height on the staircase side of the staircase door.
- (5) Where locking is required for doors of smoke-stop lobby, fire lift lobby or exit staircase on the re-entry floor, they shall be fitted with an electro-mechanical locking device complying with *Cl.2.3.9k.(1)*.

Note: Where the doors of exit staircases, smoke-stop lobbies or fire lift lobbies are provided with one-way locking device or electromechanical lock, a signage, though not mandatory, should be provided to warn occupants that they would not be able to re-enter the floor should they exit from it. The signage should be positioned at the entrance into exit staircase, smoke-stop lobby or fire lift lobby.

2.3.10 External corridor

External corridor shall comply with the following requirements:

- a. the vertical height of the unobstructed and uninterrupted ventilation opening measured from the parapet wall/balustrade/grille/railing up to the top edge of the opening or eaves of overhang shall not be less than 1.2m;
- b. where the external corridor is roofed over, the depth of the roofed over portion shall not exceed 3m;
- c. where any room or space with sleeping risk is located along the corridor, a 1-hr fire resistance rating wall of height not less than 1.1m, measured from the finished floor level of the external corridor to the sill level of the opening, shall

be provided along the corridor leading to the exits. Any ventilation openings above the fire-rated wall shall be of non-combustible construction;

- d. the door opening into the external corridor need not be fire-rated;
- e. the provision of parapet wall, or balustrade for an external corridor shall be at most 1.1m and at least 1m in height along the outer side of the corridor; and
- f. the length of external corridor with unobstructed and uninterrupted openings above the parapet wall shall not be less than 6m and shall abut an external space.

2.3.11 Air well

- a. The minimum size of an air well shall comply with [Table 1.4.2](#) for ventilation of:
 - (1) exit staircases; and
 - (2) exit passageways (as an extension to an exit staircase).
- b. An air well shall have a minimum clear area of 93m² and minimum width of 6m and without obstruction vertically throughout the airspace for ventilation of:
 - (1) smoke-stop lobby;
 - (2) external corridor;
 - (3) external exit passageway;
 - (4) cross-ventilated corridor/lobby;
 - (5) common internal corridor stipulated under [Cl.9.2.1a.\(10\)\(b\)](#); and
 - (6) internal corridor of hotel, hostel, service apartment, healthcare occupancy, workers' dormitories and the like.

2.3.12 Remoteness of exits

- a. Where more than one exit is required from a building or portion thereof, such exits shall be remotely located from each other and shall be arranged and constructed to minimise the possibility that more than one can be rendered unusable by any one fire or other emergency condition.
- b. If two exits or exit access doors are required, they shall be placed at a distance from one another equal to or not less than half the length of the maximum overall diagonal dimension of the building or area to be served, measured in a straight line between the furthest edges of the exit doors or exit access doors (see [Diagram 2.3.12b. - 1 to 5](#)), subject to the following:
 - (1) if the distance between the 2 exits or exit access doors is less than half the length of the maximum overall diagonal dimension of the building or area to be served, it shall be considered as a one-way escape arrangement;

- (2) the separation distance measured in a straight line between the furthest edges of the doors of the two exits (exit staircases, exit passageways or exit ramps) shall not be less than 7m.; and
- (3) for PG II buildings, the separation distance of the exits on the residential floor shall not be less than half the length of the maximum overall diagonal dimension of the protected lobby/corridor or external corridor.

c. Reduction in exit separation

In buildings protected throughout by an approved automatic sprinkler system which complies with the requirements of Chapter 6, the minimum separation distance between two exits or exit access doors measured in accordance with *Cl.2.3.12a. & b.* shall be not less than one third the length of the maximum overall diagonal dimension of the building or area to be served. The separation distance measured in a straight line between the furthest edges of the doors of the two exits (exit staircases, exit passageways or exit ramps) shall not be less than 7m.

d. Exit separation measured along exit access corridor

Where two exit staircases, exit passageways or exit ramps are interconnected by a corridor, exit separation can be measured along the line of travel within the exit access corridor. The exit access corridor connecting the exit staircases, exit passageways or exit ramps shall be protected by minimum 1-hr fire-rated enclosures. Doors opening into this corridor shall have minimum ½-hr fire resistance rating (see *Diagram 2.3.12d.*). The separation distance measured along the line of travel within the exit access corridor between the furthest edges of the doors of the two exits (exit staircases, exit passageways or exit ramps) shall not be less than 7m.

e. One-way travel

- (1) A one-way travel or “common path” exists if a floor space is arranged or provided with partitioning works such that occupants within that space are able to travel in only one direction to reach any of the exits or to reach the splitting point where they have the choice of two or more routes of travel to remote exits.
- (2) The travel distance from the most remote point to the splitting point shall not exceed the permissible one-way travel distance allowed in *Table 2.2A*. At the splitting point, the angle of divergence between any two alternative routes shall not be less than 90° in order that the routes originating from the splitting point can be considered as two-way travel.
- (3) The aggregate travel distances of the one-way travel from the most remote point to the splitting point and the continuous two-way travel from the splitting point to the nearest exit shall not exceed the permissible two-way travel distance allowed in *Table 2.2A*.

2.4 SPECIAL REQUIREMENTS FOR PERSON WITH DISABILITIES (PWDs)

2.4.1 General

- a. The following buildings/usages are exempted from these requirements:
 - (1) PG I and II buildings;
 - (2) healthcare occupancies, except custodian-care facility and ambulatory healthcare centre;
 - (3) industrial buildings/usages that are exempted from barrier-free accessibility compliance, as required by the authority having jurisdiction on accessibility in the built environment; and
 - (4) non-residential buildings/usages, such as car parks and clubhouses located within residential developments and which are intended for ancillary use, are not required to comply with these requirements.
- b. The escape routes shall be free from any obstacle that may cause undue delay to PWDs during evacuation, e.g. raised thresholds or steps. Where there are minor changes in level within any storey, a ramp conforming to the requirements stipulated in the “Code on Accessibility in the Built Environment” shall be provided.

2.4.2 PWD Holding Point

a. **Purpose**

A PWD Holding Point shall be provided on all storeys, including all basement levels, except first storey or storey at grade level, for PWDs to safely wait for assistance in evacuation.

b. **Siting of PWD Holding Point**

- (1) There shall be at least two designated PWD Holding Points remotely positioned on every storey of a building except for a building designed with a single exit staircase allowed under this Code. The corridor serving as escape route shall have a minimum clear width of 1.2m.
- (2) The PWD Holding Point shall be kept free of obstruction and sited within the following locations/areas in the order of priority (see *Diagrams 2.4.2b.(2) – 1 to 4*):
 - (a) Evacuation lift lobby.
 - (b) Fire lift lobby.
 - (c) Smoke-stop lobby or external corridor.
 - (d) Exit staircase.
- (3) The PWD Holding Point located in the above areas shall be positioned

away from the edge of the exit staircase and path of person escaping from the occupied space. It shall not reduce/encroach onto the required dimensions/spaces of the above areas.

c. Signage

Where a PWD Holding Point is located, a mandatory sign worded “PWD Holding Point” shall be prominently displayed.

2.4.3 Communication provisions

A suitable means of communication shall be provided between the PWD holding point and FCC or any 24-hourly manned station, for PWDs to call for assistance during a fire emergency. It can be in the form of a distress button or voice communication. The means of communication shall:

- a. be located between 800mm and 1.2m above ground level;
- b. be appropriately labelled;
- c. be provided with prominently displayed clear instruction sign on its operation; and
- d. when the device for communication is activated, it shall generate a clear visual indication to indicate that the distress signal has been relayed.

2.4.4 Dimension requirements of PWD Holding Point

A PWD Holding Point shall be adequately sized so as to accommodate a wheelchair user and to allow the user to manoeuvre easily. In this respect, the PWD Holding Point shall meet the following requirements:

- a. the space provided for a wheelchair in a PWD Holding Point shall be at least 900mm X 1.4m to allow for manoeuvring of the wheelchair;
- b. where a PWD Holding Point is sited inside a protected exit staircase, smoke-stop lobby or fire lift lobby, the wheelchair space shall not result in reduced size of these spaces and its access shall not obstruct the flow of evacuation; and
- c. the PWD Holding Point shall be marked on the ground with a wheelchair symbol in white against contrasting background, with a dotted white rectangular outline.

2.4.5 Protection of PWD Holding Point

A PWD Holding Point shall be enclosed with fire-resisting construction (other than any part that is an external wall of a building) and shall be served directly by a safe route to a storey exit, evacuation lift or final exit.

2.4.6 Exit staircase

a. **Handrails**

The handrails within a protected staircase shall be continuous.

b. **Wheelchair stairlifts**

A wheelchair stairlift, where installed, shall be sited inside a protected staircase. Such a stairlift, when in operating position, shall not encroach into the escape path of building occupants.

2.4.7 Ramp

Internal and external exit ramps can be used as exits in lieu of internal and external exit staircases or evacuation lifts subject to compliance with [Cl.2.3.3](#) and [Cl.2.3.8](#), and “Code on Accessibility in the Built Environment” and any subsequent amendment/ addendum.

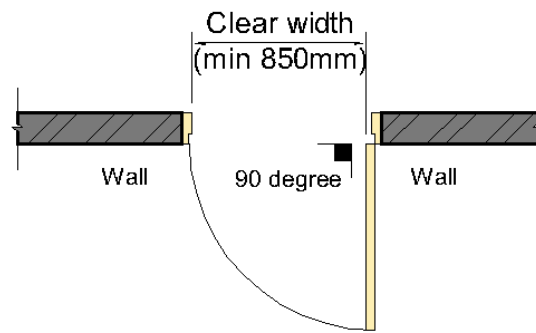

SINGLE LEAF DOOR

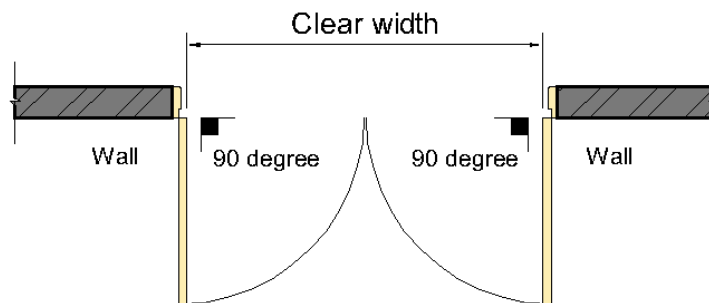

2 LEAF DOOR

Sequential door closer shall be provided to both leaves

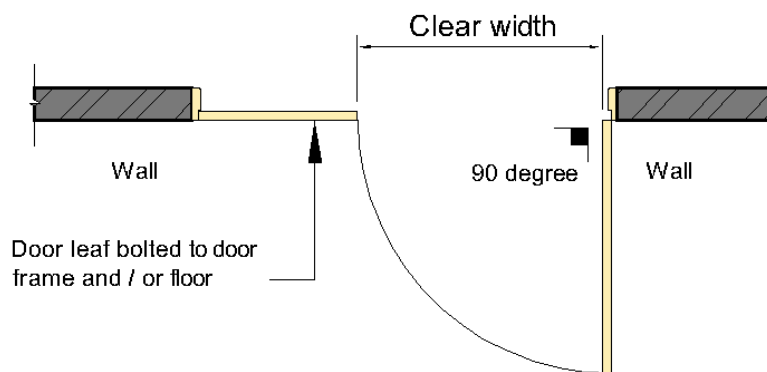

2 LEAF DOOR

(With one door leaf bolted to the door frame and / or floor)

[Diagram 2.2.9b. - Measurement of width of exit doors](#)

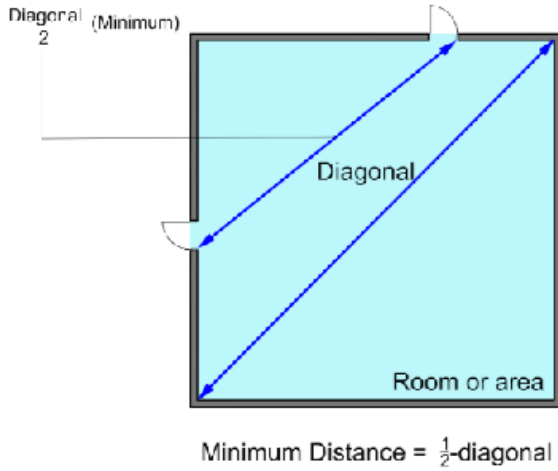

[Diagram 2.3.12b. - 1](#)

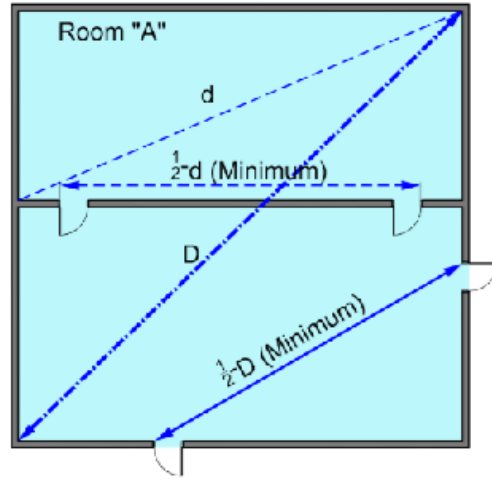

[Diagram 2.3.12b. - 2](#)

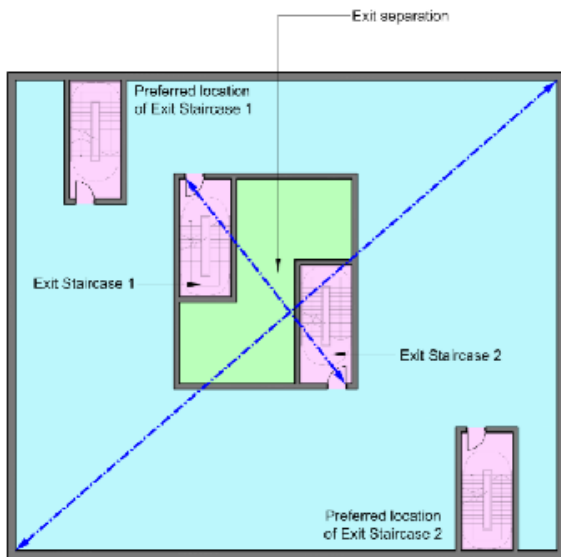

[Diagram 2.3.12b. - 3](#)

One-way escape arrangement

The distance between the exit of staircases S1 & S2 is less than half the length of the max. overall diagonal dimension of the building or floor space.

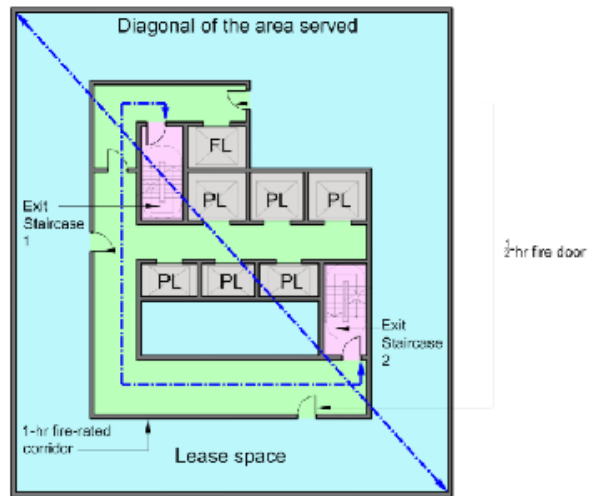

[Diagram 2.3.12b. - 4](#)

Two-way escape arrangement

Exit separation between the exit staircases S1 & S2 can be based on the travel distance in the exit access corridor enclosed with 1-hr fire-rated walls and 1/2-hr fire-rated doors.

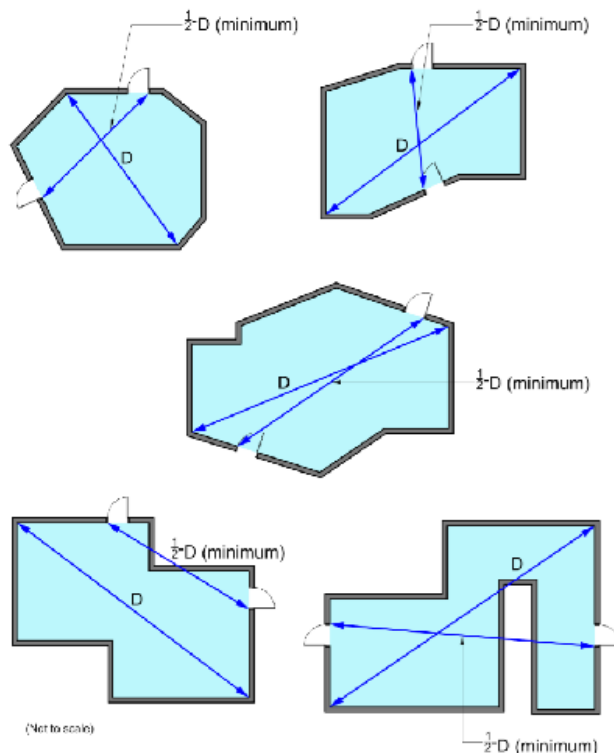

Diagram 2.3.12b. - 5 : Remoteness of exit staircase - Arrangement of exits

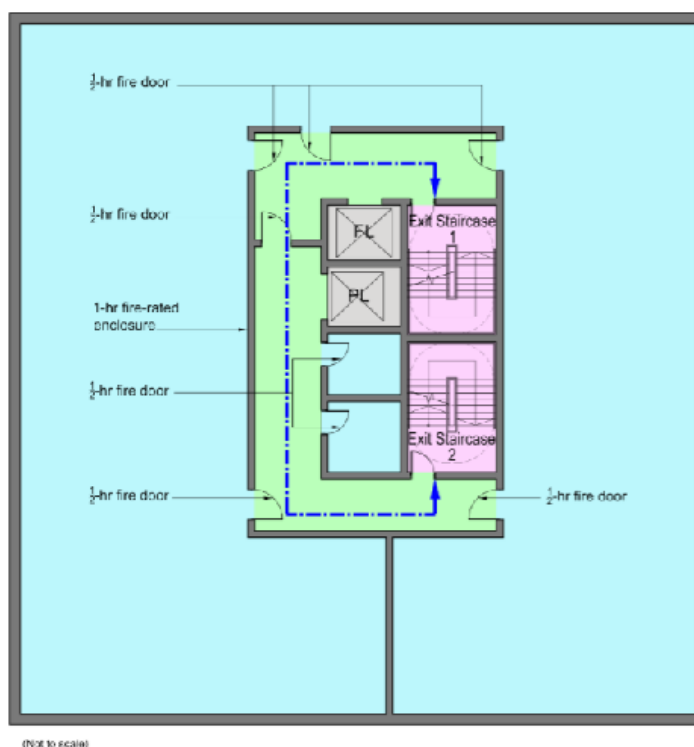
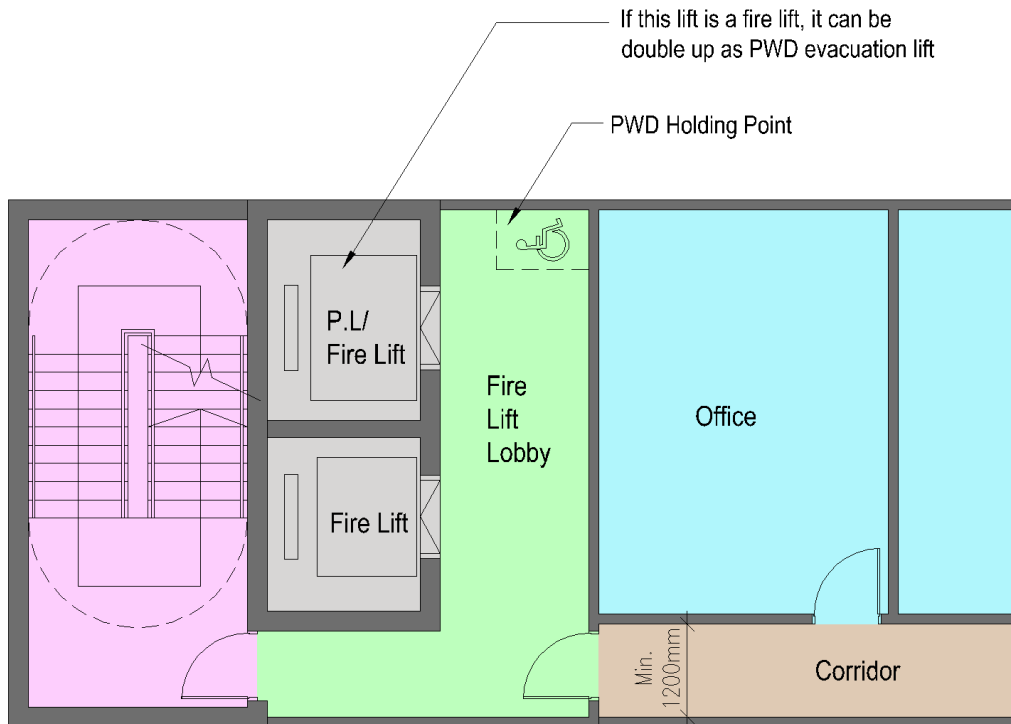
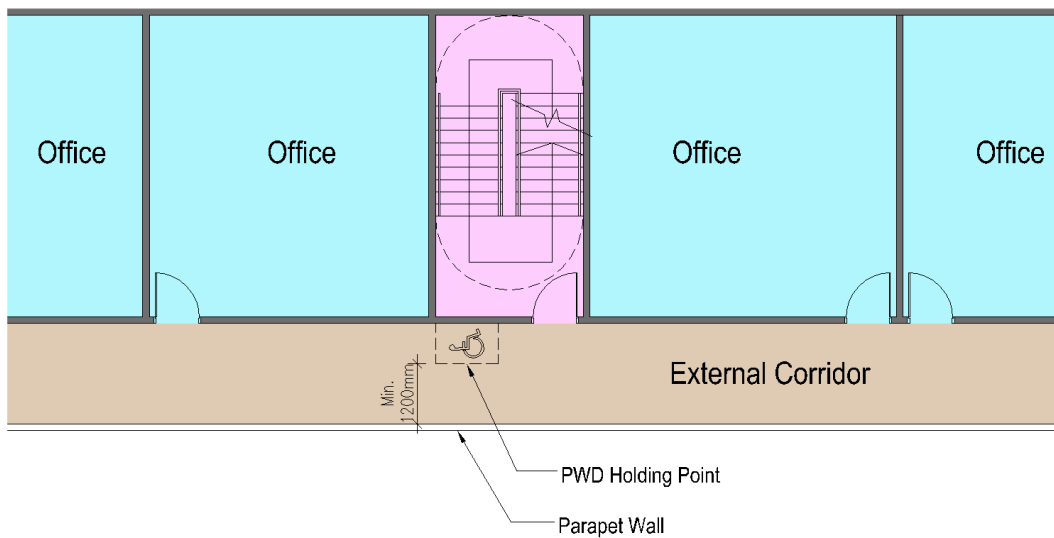

Diagram 2.3.12d. : Remoteness of exit staircase - Arrangement of exit staircase

Remoteness of exits is measured along 1-hr fire-rated corridor with 1/2-hr fire doors. In place of measuring physical distance between exit stair enclosure, distance for purposes of determining remoteness is permitted to be measured along a protected corridor.



[Diagram 2.4.2b.\(2\) - 1 : PWD Holding Point located within fire lift lobby](#)



[Diagram 2.4.2b.\(2\) - 2 : PWD Holding Point located within external corridor](#)

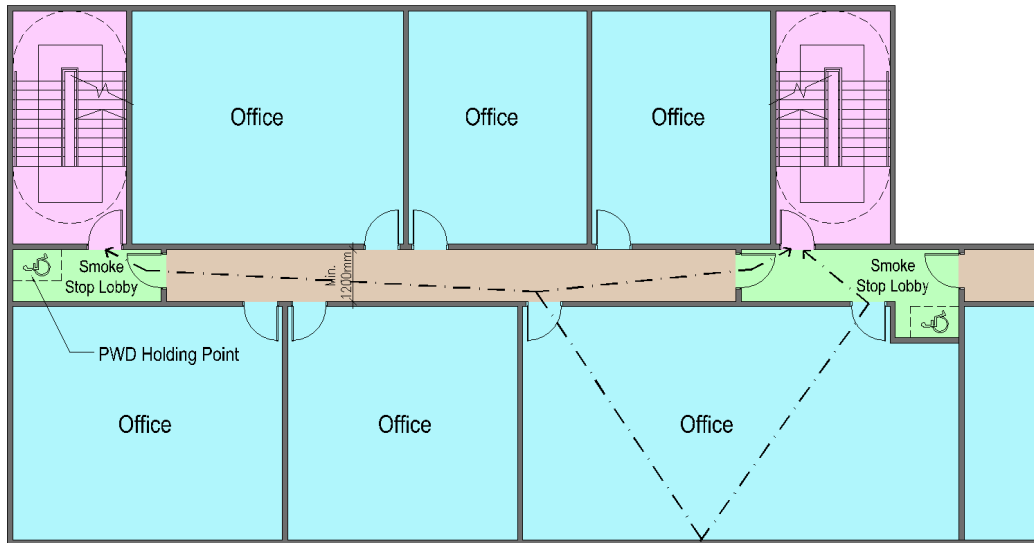

[Diagram 2.4.2b.\(2\) - 3 : PWD Holding Point located within smoke-stop lobby](#)

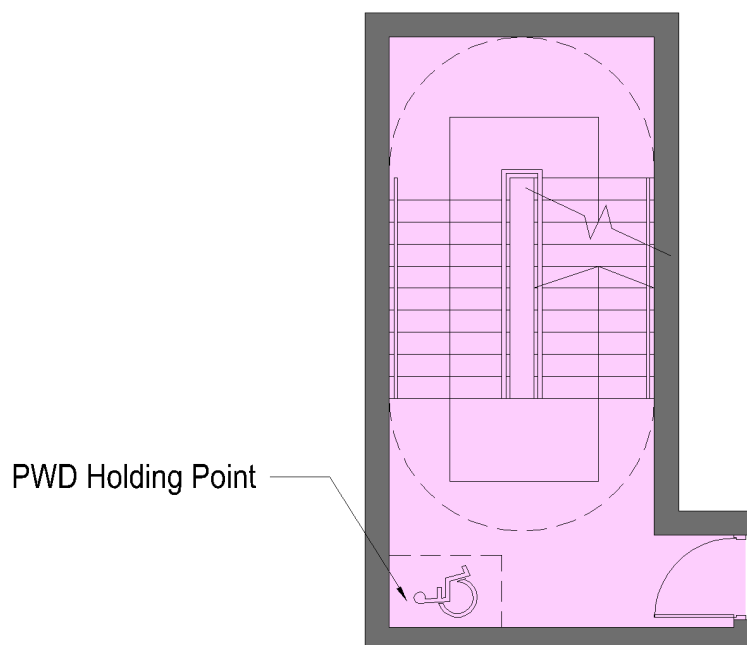

[Diagram 2.4.2b.\(2\) - 4 : PWD Holding Point located within exit staircase](#)

TABLE 2.2A : DETERMINATION OF EXIT REQUIREMENT

Type of Occupancy	Max Travel Distance (m)			Capacity No of persons per unit of width ^(x)				Min Width (m)		Max Dead End (m)	
	Two-way travel			Door opening ^{(c), (d) & (e)}	Stair-cases ^(f)	Ramps Corridors Exits Passage-ways ^(d)	Stairs	Corri-dors	Corridors		
	One-way travel	Sprin-klered	Non-sprin-klered						Sprin-klered	Non-sprin-klered	
High hazard	10	20	20	50	40	30	1	1.2	15	20	
Industrial buildings (factories, workshops, godown/warehouse)	15	25	30	100	80	60	1	1.2	15	20	
Shops, healthcare facility (outpatient)	15	25	45	100	80	60	1	1.2	15	20	
Offices	15	30	45	100	80	60	1	1.2	15	20	
Places of public resort & carparks	15	25	45	100	80	60	1 ^(b)	1.2 ^(b)	15	20	
Schools & educational buildings	15	25	45	100	80	60	1	1.5 ^(a)	15	20	
Healthcare facility (inpatient)	15	25	30	30	30	15	1	2 ^(b)	15	20	
Hotels, Boarding Houses, Serviced Apartments, Hostels, Backpackers Hotel, Dormitories	15	20	30	60	50	45	1	1.2	15	20	
Blocks of flats/maisonettes ^(k)	15 ^(g) 20 ^(h)	30 ^(g) 40 ^(h)	30 45 ⁽ⁱ⁾	50	40	30	1 ⁽ⁱ⁾	1.2	15	20	
Detached, semi-detached & terrace house, including townhouses	NR	NR	NR	NR	NR	NR	0.9	0.9	NR	NR	

Note:

NR = No requirements. Maximum direct distance = $\frac{2}{3}$ x Maximum travel distance (see [Cl.1.4.32](#))

(x) = Unit of width 500mm

(a) = Applies to corridors serving classrooms. Other corridors shall have a minimum width of 1.2m

(b) = Applies to corridors serving patients. Other corridors shall have a minimum width of 1.2m

(c) = See [Cl.2.3.9](#)

(d) = See [Cl.2.3.8](#)

(e) = Where a door opening is divided by mullions into two or more openings, each such opening shall be measured separately in computing the number of units of exit width

(f) = See [Cl.2.2.15](#) regarding reduction of exit provision

(g) = For travel distance in single staircase flats (see [Cl.9.2.1a.\(8\)](#))

(h) = Refer to [Cl.9.7.3a](#).

(i) = Staircase within maisonette serving as an internal access to be at least 900mm width

(j) = Applies to external corridor (see [Cl.2.3.10](#))

(k) = Measurement of travel distance is from the residential unit door to exit (see [Cl.9.2.1a.\(5\)](#))

The background of the page is a detailed architectural floor plan of a building, rendered in a light gray, semi-transparent style. The plan shows various rooms, corridors, and structural elements, with some areas labeled like 'Unit A' in the bottom left. The overall aesthetic is technical and professional.

CHAPTER

03

**STRUCTURAL
FIRE PRECAUTIONS**

Unit A

CHAPTER

3

STRUCTURAL FIRE PRECAUTIONS

3.1 GENERAL

The purpose of this chapter of the Code is to stipulate requirements to minimise the risk of spread of fire between adjoining buildings by separation, prevent the untimely collapse of buildings in the event of fire by the provision of a stable and durable form of construction and prevent the spread of fire between specified parts of the buildings by the division of such buildings into compartments.

3.2 PROVISION OF COMPARTMENT WALLS AND COMPARTMENT FLOORS**3.2.1 Compartment size - floor area & cubical extent**

Any building other than a building of PG I which has any storey the floor area of which exceeds that specified as relevant to a building of that height in column (2) of [Table 3.2A](#), or a cubic capacity which exceeds that specified as relevant in column (3) of [Table 3.2A](#), shall be divided into compartments by means of compartment walls and compartment floors so that:

- a. no such compartment has any storey the floor area of which exceeds the area specified as relevant to the building in column (2) of the table; and
- b. no such compartment has a cubic capacity which exceeds that specified as relevant in column (3) of the table.

3.2.2 Cubical extent for compartment exceeding 4m in height

- a. In computing the cubical extent of compartments in single storey buildings such as factories, sport halls, markets, food courts, multi-purposes halls, cinemas, concert halls, churches, temples and similar buildings, the height of 4m shall be used where the actual height exceeds that figure.

If the compartment comprises or contains mezzanine, galleries or lofts, the full height of the compartment shall be used in computing the cubical extent for each storey, mezzanine, galleries or lofts.

- b. Where two buildings are connected by external open-sided covered walkway or open-sided covered link-bridge, the buildings are considered as separate buildings, if they comply with the following conditions:
 - (1) There is no commercial activities or other usage that would pose a fire risk within the covered walkway or link-bridge.
 - (2) The width of the covered walkway or covered link-bridge shall not exceed 5m measured from eave to eave.

3.2.3 Exemption of compartmentation

Cl.3.2.1 is not applicable if the building:

- a. is fitted throughout with an automatic sprinkler system which complies with the requirements in Chapter 6; and
- b. complies with *Cl.3.2.4*, *Cl.3.2.6*, *Cl.7.4* and *Cl.9.8.3*.

3.2.4. Compartmentation by height

- a. In any compartment except those mentioned under *Cl.9.1*, up to a habitable height of 24m, no compartment shall comprise more than three storeys. This requirement can be relaxed for atrium spaces provided the design of such spaces complies with the conditions stipulated under *Cl.3.2.6*.
- b. In any building which exceeds 24m in habitable height, no compartment shall comprise more than one storey for compartments at storey level exceeding 24m above average ground level, other than a compartment which is within a residential maisonette which may comprise two storey levels.

3.2.5 Areas requiring compartmentation

The following situations shall require compartmentation by provision of compartment walls and/or compartment floors:

a. **PG II buildings**

Any wall and floor separating a residential apartment or maisonette from any other part of the same building, unless permitted (as in the case of an external wall adjoining an external corridor, for provision of window openings).

b. **Areas of different purpose groups**

Any wall and floor separating part of a building from any other part of the same building which is used or intended to be used mainly for a purpose falling within a different purpose group, as identified under *Table 1.4A*, except the following:

- (1) ancillary offices located within a building or compartment of PG III, V, VI, VII and VIII, or.
- (2) rooms or spaces for ancillary usage located within a building or compartment of PG III to VIII as stipulated under *Cl.1.4.5*, or
- (3) rooms or spaces located within a sprinkler-protected building, unless otherwise stated in following *Cl.3.2.5* or other clauses in the Code.

c. **Floor over a basement**

Any floor immediately over a basement storey if such storey:

- (1) forms part of a building or compartment of PG II to VIII, or
- (2) has an area exceeding 100m² except that in the case of a building or

compartment of PG IV, V and VII, the SCDF can consent to exemption from the above requirements provided:

- (a) the building is fitted throughout with an automatic sprinkler system in compliance with the requirements in Chapter 6; and
- (b) if the building comprises more than one basement storey, the floor at first basement storey level is constructed as a compartment floor.

d. Basement floors

In any compartment below pavement level, no compartment shall comprise more than one storey, except in the case of PG IV, V and VII buildings as permitted under *Cl.3.2.5c.(2)* and in the case of basement used solely for car parking. No part of a basement storey shall be used for the bulk storage of highly inflammable liquids or substances of an explosive nature.

e. Fire Command Centre (FCC)

The FCC shall be separated from other parts of the same building by compartment walls and floors having at least 2-hr fire resistance rating.

f. Kitchen

In an eating establishment where a kitchen is required for the preparation of food and where open-flame cooking appliances are used, the following requirements shall be complied with:

- (1) The kitchen shall be separated from other parts of the same building by compartment wall and floor having at least 1-hr fire resistance rating. Separation requirement for kitchen can be exempted under the following conditions:
 - (a) when all the cooking facilities in the kitchen are fitted with approved extinguishing systems, or
 - (b) when there are at least 25% of the perimeter walls (excluding air well and void) of an eating establishment open directly to the external of the building, and provided any part of the floor space is within 9m from the nearest opening, or
 - (c) when there are at least 50% of the perimeter walls (excluding air well and void) of an eating establishment open directly to the external of the building, and provided any part of the floor space is within 12m from the nearest opening, or
 - (d) when an eating establishment is separated from other parts of the same building by walls and floors having 1-hr fire resistance rating and doors having at least ½-hr fire resistance rating; and provided:
 - (i) for a sprinkler-protected building, there is no restriction to the floor area of the compartment, or
 - (ii) for a non-sprinkler-protected building, the floor area of the

compartment shall not exceed 150m².

- (2) Openings in the compartment wall and floor shall comply with the relevant provisions of [Cl.3.9](#) for protection of openings.
- (3) Doors shall have at least ½-hr fire resistance rating and be fitted with an automatic self-closing device.
- (4) Where the flue or duct passes through the compartment wall or floor, the flue or duct shall be encased by non-combustible construction to comply with the requirements of [Cl.3.9.5](#), and the installation of dampers in such flue or duct is prohibited.
- (5) LPG cylinders provided for open-flame cooking activities shall not be located at the basement and the installation of LPG cylinders at other areas shall comply with the provisions in the Fire Safety (Petroleum) Regulations.

Notwithstanding all the above, the compartment where open-flame cooking activities is carried out shall not comprise more than one storey.

g. Motor vehicle workshop

A motor vehicle workshop shall be separated from any other part of the same building by compartment walls and floors having at least 2-hr fire resistance rating, and if located in a basement storey of a building, shall be separated from any other part of the same building by compartment walls and floors having at least 4-hr fire resistance rating.

h. Spray painting room

- (1) Areas in which spray painting or other related processes are performed or carried out, shall be separated from other parts of the same building by compartment walls and floors having at least 2-hr fire resistance rating. Where spray painting booths that have built-in vapour extraction system complying with NFPA 33, the fire resistance requirement is not applicable.
- (2) Where a spray painting room or booth is protected by an automatic sprinkler system but not complying with NFPA 33, the fire resistance rating for the fire compartment to the room or booth can be reduced from two hours to one hour.

i. Store room

For non-sprinkler-protected buildings, if the area of the store room exceeds 10m², it shall be compartmented from the other parts of the same building by compartment walls and floors having at least 1-hr fire resistance rating. No fire compartmentation is required for a store room which is housed within a sprinkler-protected building. However, store room exceeding 700m² and 100m² for above-ground and below-ground respectively are subject to the compartment size requirements stipulated under [Cl.9.8.3](#).

j. **Areas of special hazard**

(1) **Areas of special high risk in a building**

Boiler rooms, transformer rooms, generator rooms, storage areas of materials that are highly combustible or flammable, and any other areas of special high risk shall be separated from other parts of the building by compartment walls and floors having at least 2-hr fire resistance rating. If the building is protected by an automatic sprinkler system, the fire resistance rating of the compartment walls and floors can be reduced to one hour.

(2) Room housing transformer that uses flammable liquid shall be located at ground level against an external wall.

(3) Diesel fuel tank for generator need not be located against an external wall.

3.2.6 Provision for atrium spaces

The SCDF can consent to modify the requirements under *Cl.3.2.1* and *Cl.3.2.4a* of this Code for the design of atrium spaces in a building provided all of the following conditions are complied with:

- a. The minimum plan area of the atrium void shall be not less than 93m² and no horizontal dimension between opposite edges of the floor opening is less than 6m wide.
- b. Occupancy within the floor space of the atrium meets with the specification for low or ordinary hazard content.
- c. The atrium is open and unobstructed in a manner such that it can be assumed that a fire in any part of the space will be readily obvious to the occupants before it becomes a hazard.
- d. The building is fitted throughout with an automatic sprinkler system to comply with the requirements in Chapter 6.
- e. The building is fitted with an engineered smoke control system in accordance with *Cl.7.4.5*.
- f. Provision of openings and enclosures, and the planning of means of escape shall be subject to the approval of the SCDF.

3.2.7 Buildings of high hazard occupancy

- a. The compartment of buildings of high hazard occupancy shall not exceed one half of the sizes given in *Table 3.2A* and each compartment shall comprise one storey only.
- b. No storey of a building, the habitable height of which is more than 24m, shall be used for the bulk storage of goods or substances of highly combustible nature unless the building is provided with a sprinkler system to comply with Chapter

- 6.
- c. The type of storage materials or substances shall not include the following:
 - (1) materials with an auto-ignition temperature lower than 200°C; and
 - (2) combustible/highly flammable materials which include those highlighted in sub-clauses a., b., c. and d. of [Cl.1.4.67](#).

3.2.8 Exemption on size limitation of compartment

The requirements of [Cl.3.2.1](#) for car parking decks can be exempted if both the following are complied with:

- a. The car parking decks shall be open-sided with not less than 50% of the sides permanently open and unobstructed. Such openings shall be evenly distributed along each of the perimeter walls and on every individual floor/deck, excluding perimeter walls to air well, so as to provide cross ventilation to all parts of the car parking decks.
- b. No part of the floor space shall be more than 12m from the openings on the perimeter walls of the building or air well. Air well where provided for this purpose shall have a superficial plan area of not less than 10m², or 0.1m² for every 300mm of height, whichever is greater, and have a minimum dimension on plan of 2m, open vertically to the sky for its full height.

3.2.9 Separation of area undergoing addition & alteration works

For additions and alterations to existing buildings, the areas undergoing such works shall be separated from other occupied areas of the building in accordance with [Cl.3.15.16](#).

3.3 FIRE RESISTANCE OF ELEMENTS OF STRUCTURE

3.3.1 Interpretation and application

The interpretation and application of [Cl.3.3](#) shall be as follows:

- a. Subject to the provisions of [Cl.3.3.1b](#) and any other expressed provision to the contrary, any reference to a building of which an element of structure forms a part means the building or (if the building is divided into compartments) any compartment of the building, for which the element forms a part.
- b. Any reference to height means the height of a building, but if any part of the building is completely separated throughout its height both above and below ground from all other parts by a compartment wall or compartment walls in the same continuous vertical plane, any reference to height in relation to that part means the height solely of that part.
- c. If any element of structure forms part of more than one building or compartment and the requirements of fire resistance specified in [Table 3.3A](#), in respect of one building or compartment, and differs from those specified in

respect of any other building or compartment of which the element forms a part, such element shall be so constructed as to comply with the greater or greatest of the requirements specified.

- d. If any element of structure is required to be of non-combustible construction, the measure of fire resistance rating shall be determined by the part which is constructed wholly of non-combustible materials. (With the exception of fire protecting suspended ceilings, surface materials for walls and ceilings and floor finishes can be combustible, if they are not relied on to contribute to the fire resistance of the wall or floor).

3.3.2 Minimum periods of fire resistance

Subject to any expressed provision to the contrary, any element of structure shall be constructed of non-combustible materials and is required to have fire resistance for not less than the relevant period specified in [Table 3.3A](#), with regards to the purpose group of the building of which it forms a part and the dimensions specified in that table, provided that:

- a. any separating wall shall have at least 1-hr fire resistance rating; and
- b. any compartment wall or compartment floor which separates a part of a PG II or III buildings, from any other part of the building of a purpose group other than PG II or III shall have at least 1-hr fire resistance rating.

3.3.3 Exemption for non-load-bearing external walls

The requirement on fire resistance in [Cl.3.3.2](#) shall not apply to:

- a. any part of any external wall which is non-load-bearing and can, in accordance with [Cl.3.5](#) be an unprotected area, or
- b. steel structures of a standalone car park for passenger vehicles of Class 3 and below (unladen weight not exceeding 2500kg) if all of the following conditions are fulfilled:
 - (1) Each storey shall be provided with cross ventilation by the provision of uninterrupted openings evenly distributed around the perimeter walls, excluding perimeter walls to air well. The area of the openings shall not be less than 50% of all external walls or 15% of the footprint per storey, whichever is greater. This condition is not applicable if a sprinkler system is installed throughout the car park.
 - (2) No point on any storey shall be more than 12m from the external air or air well. An air well, where provided for this purpose, shall have a superficial plan area of not less than 10m², or 0.1m² for every 300mm of height, whichever is greater, and have a minimum dimension on plan of 2m, open vertically to the sky for its full height. This condition is not applicable if a sprinkler system is installed throughout the car park.
 - (3) All floor beams shall be designed as a composite structure with the floor slab.

- (4) The building is not more than 24m in habitable height, and there shall not be any basement storeys;
- (5) No other usages, other than the electrical services that serve only the car park, are permitted;
- (6) Steel structures shall meet the specifications of SS EN 1993-1-2 and SS EN 1994-1-2.

3.3.4 Exemption for single storey buildings

In the case of a single storey building or a building consisting of a first storey and one or more basement storeys, the requirement on fire resistance in [Cl.3.3.2](#) shall not apply to any element of structure which forms part of the first storey and consists of:

- a. a structural frame or a beam or column, provided that any beam or column (whether or not it forms part of a structural frame) which is within or forms part of a wall, and any column which gives support to a wall or gallery, shall have fire resistance of not less than the minimum period, if any, required by this Code for that wall or gallery, or
- b. an internal load-bearing wall or a load-bearing part of a wall, unless that wall or part of it forms part of a compartment wall or a separating wall, or forms part of the structure enclosing a protected shaft or supports a gallery, or
- c. part of an external wall which does not support a gallery and which may, in accordance with [Cl.3.5](#) be an unprotected area.

3.3.5 Suspended ceiling

In determining the fire resistance of floors, no account shall be taken of any fire resistance attributable to any suspended ceiling unless the ceiling is constructed specifically as a fire protecting suspended ceiling, and the construction complies with the requirements under [Table 3.3B](#) for Limitations on Fire Protecting Suspended Ceilings.

3.3.6 Fire-rated board

- a. Fire-rated boards are permitted to be used for protection to structural steel beams, columns and as wall construction in building if all of the following are complied with:
 - (1) The fire-rated boards shall be non-combustible (BS 476 Pt 4 or Pt 11).
 - (2) They shall have fire resistance for not less than the relevant period specified in [Table 3.3A](#), with regards to the purpose group of the building of which it forms a part and the dimensions specified in that table.
 - (3) They shall meet the criteria, in terms of water absorption and bending strength performance, when subject to the test standards of BS EN 520 (for gypsum plaster board) or ISO 1896 (for calcium silicate or cement board).

- (4) Fire-rated boards used to make dry walls shall meet the criteria, in terms of impact & deflection performance, when subject to the test of BS 9999 Annex L and BS 5234 Part 2.
 - (5) They shall not be used to protect structural steel in areas which are subject to explosion risk, as the boards may be displaced by the force of the blast.
 - (6) In buildings under PG VI and VIII, where the presence of corrosive atmosphere may affect the effectiveness of fire-rated boards for protection to structural steel members of buildings, such proposals shall be subject to evaluation of the SCDF.
- b. Incorporation of services within fire-rated drywall construction shall comply with the following:
- (1) The installations shall meet the fire performance test requirements set out in BS 476 Part 22 and shall not incorporate services beyond the case scenario for which it has been successfully tested.
 - (2) Electrical cables shall be housed in metal conduits within the dry construction.
 - (3) Gas pipe installation are prohibited in fire-rated dry construction.

3.4 TESTS OF FIRE RESISTANCE

3.4.1 Fire resistance

Performance for the fire resistance of elements of structure and other forms of construction shall be determined by reference to the methods specified in BS 476: Part 20 to 23, which specify tests for stability, integrity and insulation.

Specific requirements for each element in terms of the three performance criteria of stability, integrity and insulation are given in [Table 3.4A](#).

3.4.2 “Deem to satisfy” provisions

An element of structure or other part of a building shall be deemed to have the requisite fire resistance if:

- a. it is constructed to the same specification as that of a specimen exposed to test by fire in accordance with the method and procedure under BS 476: Part 20 to 23, and satisfied the requirements of that test for the three performance criteria of stability, integrity and insulation for not less than the specified period, or
- b. in the case of a wall, beam, column, stanchion or floor to which [Annex 3A](#) to [Cl.3.4](#) relates, it is constructed in accordance with one of the specification set out in that Annex and the notional period of fire resistance given in that Annex as being appropriate to that type of construction and other relevant factors is not less than the specified period.

3.5 EXTERNAL WALL

3.5.1 Requirements of external walls

The requirements of external walls are as follows:

- a. Any external wall of a building or a separated part of a building which constitutes or is situated within a distance of 1m from any point on the relevant boundary, or is a wall of a building or a separated part of a building which exceeds 15m in height shall:
 - (1) be constructed wholly of non-combustible materials apart from any external wall finishes which complies with *Cl.3.5.4* or any internal lining which complies with *Cl.3.13.4*;
 - (2) be so constructed as to attain the fire resistance required by this chapter; and
- b. any beam or column forming part of an external wall, and any structure carrying an external wall which is required to be constructed of non-combustible material, shall comply with the provisions of *Cl.3.5.1a.*

3.5.2 Exceptions on external wall construction

- a. The requirements of *Cl.3.5.1a.(1)* for non-combustibility of external walls need not apply to the external wall of a building or part of a building separated as described in *Cl.3.3.2b.*, if that wall is situated 1m or more from the relevant boundary and it is:
 - (1) of PG I or II building of not more than three storeys, or
 - (2) of single storey construction and not exceeding 15m in height and floor area not exceeding:
 - (a) 3000m² for PG III, IV, VII buildings, or
 - (b) 2000m² for PG V, VI buildings, or
 - (c) 500m² for PG VIII buildings, or
 - (3) of other than single storey buildings, but not exceeding 7.5m in height and the compartmented floor area not exceeding:
 - (a) 250m² for PG IV, V, VII buildings, or
 - (b) 150m² for PG VI, VIII buildings.
- b. The requirements of *Cl.3.5.1a.(2)* for fire resistance of external walls need not apply to the external wall of a building or part of a building separated as described in *Cl.3.3.2b.*, if that wall is situated 1m or more from the relevant boundary and it is:
 - (1) of a single storey building of a purpose group other than PG VI and VIII

and not exceeding 15m in height, or

- (2) of a single storey PG VI or VIII building not exceeding 15m in height and floor area not exceeding 2000m² or 500m² respectively.

3.5.3 Unprotected areas in any side of a building

Unprotected areas in any side of a building shall comply with all of the following:

- a. Any relevant requirements relating to the permitted limits of unprotected areas specified in [Annex 3B](#), unless the building is so situated that such side can in accordance with [Annex 3B](#), consist entirely of any unprotected area.
- b. The extent of unprotected openings in an external wall of a building/compartment, in relation to its distance from the lot boundary, can be doubled that of [Annex 3B](#), provided the building/compartment is fitted throughout with an automatic sprinkler system in compliance with the requirements in Chapter 6.
- c. As an alternative to *Cl.3.5.3b.* above, the distance between the external wall of a building and the relevant boundary can be half that specified in [Annex 3B](#), if the building is fitted throughout with an automatic sprinkler system in compliance with the requirements in Chapter 6.
- d. The extent of unprotected openings in an external wall of a building/part of building used for car parking in relation to its distance from the lot boundary/relevant boundary can be based on the floor having the largest extent of unprotected openings to comply with [Table 1](#) of [Annex 3B](#).
- e. Extent of unprotected openings
 - (1) The extent of unprotected openings in an external wall of a building under PG I, in relation to its distance from the relevant boundary, can be based on the internal room/space in the building that has the largest extent of unprotected openings to comply with [Table 1](#) of [Annex 3B](#).
 - (2) Internal walls enclosing the room/space in the building are not required to be fire-rated, but shall be constructed of non-combustible materials, except glazing.

3.5.4 External wall finishes

Finishes on external walls shall comply with the following:

- a. Homogenous cladding on external walls shall be constructed of material of at least limited combustibility tested in accordance with BS 476 Part 11 or approved equivalent. For buildings not within PG VI and VIII, any part of such cladding below a height of 15m from the ground, and situated at least 1m away from the relevant boundary can consist of:
 - (1) timber of not less than 9mm finished thickness, or

- (2) a material having a surface which achieves at least:
 - (a) Class 0 flame-spread rating tested in accordance with BS 476 Part 6 & 7, or
 - (b) Class B rating classified under EN 13501-1.
- b. Composite panels used as cladding on external walls shall comply with [Cl.3.15.13](#).

3.5.5 Reference to Part I & II of Annex 3B

Any reference to [Annex 3B](#) shall be construed as referring to the provisions of Part I of that Annex together with the provisions of Part II.

3.5.6 Buildings on land in common occupation

If two or more detached buildings are erected on land in common occupation, for any external wall of such a building facing the external wall of an adjacent building, the relevant boundary shall be a notional boundary passing between those buildings. This notional boundary shall be positioned to enable the external walls of those buildings to comply with the requirements of [Cl.3.5.3](#).

3.5.7 Vertical fire spread

- a. For high and low parts of different compartments of a building abutting each other, either one of the following requirements shall be complied with to prevent spread of fire between the distinct parts:
 - (1) the roof-over of the lower part of the building shall be fire-rated in accordance with the element of structure for minimum 1 hr for a distance of 5m measured horizontally from the external wall of the higher part of building; or
 - (2) the external wall of the higher part of the building overlooking the roof below shall have the necessary fire resistance rating in accordance with the element of structure for minimum 1 hr for a vertical height of not less than 9m measured from the roof of the lower part of the building.
- b. The above requirements shall not be applicable to:
 - (1) buildings or lower parts of the building which are sprinkler-protected;
 - (2) the buildings under the conservation programme of the authority having jurisdiction, or buildings built before 1969;
 - (3) covered car porches intended solely for the purpose of the boarding and alighting of passengers;
 - (4) open-sided/covered walkways/linkways not exceeding 5m in width with no commercial activities or storage; and

- (5) canopies over private enclosed spaces or balconies in PG II buildings, provided that the canopy is constructed of non-combustible material.

3.5.8 Non-sprinkler-protected roof

For non-sprinkler-protected roof within 4m from the boundary (excluding boundary abutting public street, canal or river), the portion of the roof within this 4m zone shall be 1-hr fire-rated. This requirement is exempted for areas mentioned under *Cl.3.5.7b.*

3.5.9 Separation of residential floor facade

The façade of residential floors above 24m habitable height shall be separated from each other by:

- a. a 1-hr fire-rated spandrel that, when installed, measures at least 1.5m in height, or
- b. a 1-hr fire-rated horizontal projection that extends at least 600mm from the building.

3.5.10 External sun-breakers/weather features

External sun-breakers or weather features which will result in the channelling of flame upwards during a fire are not permitted.

3.6 SEPARATING WALLS

3.6.1 Requirements of separating walls

- a. Every separating wall shall:
 - (1) form a complete barrier in the same continuous vertical plane through the full height between the buildings it separates, including roofs and basements and shall be without openings, except where permitted under *Cl.3.6.2*;
 - (2) have the appropriate fire resistance to comply with the requirements of *Cl.3.3*;
 - (3) be constructed of non-combustible materials, together with any beam and column which form part of the wall and any structure which it carries; and
 - (4) not include glass fire-resisting walls.
- b. **Exception**

Cl.3.6.1a.(1) need not be applied to wall between car porches of buildings under PG I. For terrace-houses, this exception shall not apply if the unprotected opening of the car porch fails to comply with the setback distance requirements from the other lot boundary.

3.6.2 Openings in separating walls

A separating wall shall have no openings except for:

- a. a door required to provide a means of escape in the event of a fire, having the same fire resistance as that required for the wall and complying with *Cl.3.9.2*, or
- b. a door provided for the purpose of public circulation and permitted by the SCDF, having the same fire resistance as that required for the wall and complying with *Cl.3.9.2*, or
- c. an opening for the passage of a pipe complying with the relevant provisions of *Cl.3.9.3*.

3.6.3 Roof junction

A separating wall shall be either extended up to form a close joint with the underside of a pitched roof of non-combustible covering or extended up above the level of such roof covering. The junction between such separating wall and roof shall be properly fire-stopped so as not to render ineffective the resistance of such separating wall to prevent the spread of fire.

3.6.4 External wall junction

If any external wall is extended across the end of a separating wall, such external wall and separating wall shall be bonded together or the junction of such walls shall be fire-stopped to comply with the requirements of *Cl.3.12*.

3.6.5 Prohibition of combustible materials in separating walls

No combustible material shall be built into, extended through, across the ends of, or over the top of separating walls in such a way as to render ineffective the resistance of such separating walls to prevent the spread of fire.

3.7 COMPARTMENT WALLS AND COMPARTMENT FLOORS

3.7.1 Requirements of compartment walls or compartment floors

Every compartment wall or compartment floor shall be required to:

- a. form a complete barrier to fire between the compartments it separates;
- b. have the appropriate fire resistance to comply with the requirements of *Cl.3.3*, except for compartment which is abutting a common circulation space and not more than 3m from the eaves of the building;
- c. be constructed of non-combustible materials (together with any beam or column which forms part of the wall or floor, and any structure which it carries); and
- d. shall not have fire-resisting glass components, unless permitted under *Cl.3.15.14*.

3.7.2 Openings in compartment wall or compartment floor

A compartment wall or compartment floor shall have no openings in it, except for

- a. a door which has the same fire resistance rating as the compartment wall and complies with the relevant requirements of *Cl.3.4*, unless permitted by other provisions of the Code, or
- b. a protected shaft which complies with the requirements of *Cl.3.8*, or
- c. the passage of a pipe or ventilation duct.

Such openings in the compartment wall or compartment floor shall be protected to comply with the relevant provisions of *Cl.3.9*.

3.7.3 Openings

a. Junction with other structures

Where a compartment wall or compartment floor forms a junction with any structure comprising any other compartment wall, or any external wall, separating wall or structure enclosing a protected shaft, such structures shall be bonded together at the junctions or the junctions shall be fire-stopped to comply with the requirements of *Cl.3.12*.

b. Opening in curtain walling

The opening occurring at the junction between the edge of a structural floor and the curtain walling shall be sealed to prevent the spread of smoke and flame from the lower floor to the upper floor via the opening. Materials to be used for sealing the opening shall have the requisite fire resistance rating as the elements of structure.

3.7.4 Compartment wall - roof junctions

Where a compartment wall forms a junction with a roof, such compartment wall shall be extended up to form a close joint with the underside of the roof and shall be properly fire-stopped or shall be extended up above the level of the roof covering and the junction between such compartment wall and roof shall be properly fire-stopped so as not to render ineffective the resistance of such compartment wall to the effects of the spread of fire.

3.7.5 Prohibition of combustible materials

No combustible material shall be built into, extended through or extended across the ends of any compartment wall or compartment floor or extended over the top of any compartment wall in such a manner as to render ineffective the resistance of such wall or floor to the effects of the spread of fire.

3.7.6 Non-combustibility of compartment walls or floors

Every compartment wall or compartment floor shall be constructed of non-combustible materials, unless permitted by the SCDF.

3.7.7 Use of fire shutter

a. General

A fire shutter is permitted to be used as compartment wall, except for the fire compartmentation of Fire Command Centre (FCC) and means of escape, which include exit staircases, smoke-stop lobbies/fire lift lobbies, internal exit passageways, etc..

b. Fire resistance

The fire shutters, which are used to protect openings in compartment wall/floor, shall have the necessary fire resistance including thermal insulation, not less than that of the compartment wall/floor. However, fire shutters, which are installed at the edge of atria, voids such as escalator void areas and between floors, and door way, need not have thermal insulation.

c. Operation

The commonly used shutters such as vertical, horizontal and lateral fire shutters shall comply with SS 489 and the following:

(1) **Vertical fire shutter operated by gravity during a fire**

Upon activation by a fire alarm system or fusible link, the operating mechanism of curtains/leaves of the vertical fire shutter shall be released. The curtain/leaves shall descend under gravity at a controlled rate.

(2) **Electrically-operated vertical, lateral and horizontal fire shutter (fusible link is not required)**

Upon activation by fire alarm system, the electrical motor shall drive the curtains/leaves to descend and shall be backed up by emergency power supply. The power and signal cables shall be fire-rated.

d. Mode of activation

The mode of activation for fire shutters at different locations shall be as follows:

(1) **Fire shutters as separating wall between two buildings**

(a) Two buildings separated by a common fire shutter:

Both gravity-operated and electrically-operated fire shutters shall be linked to the fire alarm systems of both buildings and shall be activated by the fire alarm system of either building. Activation solely by fusible link is not permitted.

(b) Two buildings separated by two separate fire shutters:

Both gravity-operated and electrically-operated fire shutters shall be activated by the fire alarm system of its own building. Activation solely by fusible link is not permitted.

(2) **Fire shutters as compartment wall/floor for limiting compartment area and cubical extent**

Fire shutters as compartment wall/floor for limiting compartment areas

and cubical extent, as compartment between different purpose groups, as compartment of special rooms such as kitchen, electrical room, store room, etc. and as compartment of basement passenger/goods lift lobby:

- (a) For gravity-operated vertical fire shutters, activation by fusible link is acceptable.
 - (b) For electrically-operated fire shutters, activation shall be by local smoke detectors.
- (3) **Fire shutters as compartmentation at atrium/voids or between floors (being part of the engineered smoke control design)**

Only electrically-operated fire shutters are permitted. The signal to operate the respective fire shutter shall be from a dedicated smoke detector installed at the respective smoke zone.

3.7.8 Exit directional signage on fire shutter and smoke curtain

Exit directional signage marked with an arrow and the word “EXIT” shall be prominently painted /pasted on fire shutters/smoke curtains to redirect building occupants to the nearest exits if the activated shutters visually obscure the building exit and/or directional signs. The signage shall be reflective and the letters at least 100mm in height.

3.7.9 Emergency generator room

- a. An emergency generator room shall be compartmented as stipulated under [Table 6.4A](#).
- b. An emergency generator can be located in an external space provided:
 - (1) the setback distance between the outdoor emergency generator from other surrounding hazards except water tank shall be at least 3m; and
 - (2) if there is more than one outdoor emergency generator, each outdoor emergency generator shall be separated from the other by a dividing wall of masonry construction for the full length and height of the adjacent outdoor emergency generator.

3.8 PROTECTED SHAFTS

3.8.1 Purpose of protected shaft

A protected shaft shall not be used for any purpose additional to those given as defined under Cl.1.4.82. All services such as, pipe/duct installation shall not be located inside a protected staircase. Likewise, no washroom is allowed to be located inside protected staircase.

3.8.2 Requirements of protected shaft

Every protected shaft shall be required to:

CHAPTER 03

- a. form a complete barrier to fire between the different compartments which the shaft connects;
- b. have the appropriate fire resistance to comply with the requirements of [Cl.3.3](#); and
- c. be constructed of non-combustible material (together with any beam or column which forms part of the enclosure and any structure which carries it).

3.8.3 Openings in protected shaft

- a. A protected shaft shall have no openings in its enclosure, except
 - (1) in the case of any part of the enclosure which is formed by a separating wall, any opening which complies with the requirements of [Cl.3.6](#) for separating walls, or
 - (2) in the case of any part of the enclosure which is formed by a compartment wall or a compartment floor, any opening which complies with the requirements of [Cl.3.7](#) for compartment wall or compartment floor, or
 - (3) in the case of any part of the enclosure which is formed by the protecting structure:
 - (a) a door which has the appropriate fire resistance to comply with the requirements of [Cl.3.4](#) for test of fire resistance, or otherwise permitted by provision of [Cl.3.8.6](#), or
 - (b) the passage of a pipe, excluding protecting structure to exit staircase and exit passageway, or
 - (c) inlets to and outlets from and opening for the duct, if the shaft contains or serves as a ventilation duct.
- b. Such openings in the protected shaft shall be protected to comply with the relevant provisions of [Cl.3.9](#) for protection of openings.

3.8.4 Non-combustibility of protecting structures

Every protecting structure shall be constructed wholly of non-combustible materials except that floor, wall and ceiling finishes which do not contribute to the fire resistance of such protecting structure are not be required to comply with the requirements for non-combustibility.

3.8.5 Ventilation of protected shaft

Ventilation of protected shaft shall comply with the following:

- a. A protected shaft used for the passage of people, such as exit staircases, shall be ventilated to comply with the relevant provisions of the Code.

- b. A protected shaft containing a pipe conveying gas shall be adequately ventilated directly to the outside air or have other modes of ventilation allowed under SS 608.

3.8.6 Doors in protecting structures

- a. Any door fitted to an opening in protecting structure shall have fire resistance for not less than half the period required by other provisions of the Code for the protecting structure surrounding the opening.
- b. **Exception**
 - (1) Any door fitted to an opening in protecting structure of a shaft containing services, such as electrical cables, pipes (including gas pipe in separate shaft), ducts etc., is not required to have the fire resistance rating if the door is located along the wall facing the external corridor.
 - (2) Any door fitted to an opening in protecting structure of a rubbish chute is not required to have the fire resistance rating if:
 - (a) the thickness of the metal hopper door is at least 1.5mm;
 - (b) the hopper door is sealed with rubber gasket; and
 - (c) the hopper door shall be self-closing type.

3.8.7 Protected shaft containing exit staircase

- a. A protected shaft which contains an exit staircase shall not contain any services e.g. pipes, cables, ducts, etc., that are not solely serving the same exit staircase (even if the services are protected with fire-rated dry construction), except for:
 - (1) cut-off sprinkler and pipe for that staircase;
 - (2) UPVC or cast iron rain water downpipes serving the roof directly above the exit staircase, and not routed through anywhere outside the staircase; and
 - (3) rising mains.
- b. The protecting structure shall be constructed of masonry, or drywall. If drywall construction is used, all of the following conditions shall be complied with:
 - (1) the drywall shall be non-combustible;
 - (2) the drywall shall have fire resistance rating for not less than the relevant period specified in [Table 3.3A](#) having regard to the purpose group of the building of which it forms a part and the dimension specified in that table;
 - (3) the drywall shall meet the criteria, in terms of impact & deflection performance, when subject to the test of BS 9999 Annex L and BS 5234 Part 2;

- (4) the drywall shall meet the criteria, in terms of water absorption and bending strength performance, when subject to the test of BS EN 520 or ISO 1896;
- (5) the drywall shall meet the criteria of Cyclic Loading and Dynamic Test as specified under Building Code of Australia Specification C 1.8; and
- (6) the building shall have at least two independent exit staircase shafts (scissors exit staircases are considered single shaft).

3.8.8 Lift shaft

A protected shaft which contains a lift shall comply with the following:

- a. It shall not contain any pipe conveying gas or combustible liquid, other than those in the mechanism of a hydraulic lift.
- b. The protecting structure shall be constructed of masonry, or drywall. If drywall construction is used, the conditions stipulated under *Cl.3.8.7b.(1) to (6)* shall be complied with.
- c. Where a lift is either located at the edge of atrium floors or at the external wall and outside the building, the lift shall be considered as not enclosed within a protected shaft.
- d. The protected shaft shall be vented in accordance with SS 550. The vents shall be so arranged as to induce exhaust ventilation of the shaft. Where vents cannot be provided because of the location of the lift shaft, a ventilation duct protected by drywall complying with *Cl.3.8.7b.* serving as ventilation of the shaft may be provided instead. If the duct is not fire-rated, fire dampers shall be provided to the duct at the wall of the lift shaft, provided such relaxation shall not apply to shafts containing a fire lift.
- e. Openings for the passage of lift cables into the lift motor room located above or at the bottom of the shaft shall be as small as practicable.
- f. A transom panel above the lift entrance shall be considered as part of the protecting structure and shall therefore conform to the fire resistance requirements of the protected structure.
- g. If it serves any basement storey, it shall be enclosed by a protected lobby with walls having 1-hr fire resistance rating and fire door of ½-hr fire resistance rating. If the protected lobby also acts as a smoke-stop lobby required under *Cl.2.2.13*, it shall be mechanically ventilated in accordance with *Cl.7.1.10*.

Exception:

Where the lift landing area is adjoining an air well or external space of minimum clear area 10m² and minimum width of 3m, the distance between the nearest edge of lift door opening to the air well shall not exceed 3m.

h. Private lift

A private lift that is provided for the exclusive use of occupants in residential buildings under PG II shall comply with all of the following requirements:

- (1) A smoke detector shall be provided at the lift landing area. The activation of any of the smoke detectors at the lift landing area shall cause the lift to home to the designated floor.
- (2) Emergency power supply from a standby generating plant shall be provided to home the lift to the designated floor when there is a power failure in the building.
- (3) An alternate designated floor (e.g. any other floor with common lobby) shall be identified. The lift shall be brought to the alternate designated floor in the event that there is a fire at the 1st storey designated floor. For buildings without an alternate designated floor, the lift shall return to the last called floor in the event that the designated floor is on fire.
- (4) The lift shall not serve as a fire lift.
- (5) Private lifts shall comply with SS 550.

3.8.9 Protected shaft containing other services installations

A protected shaft used for the enclosure of services shall comply with the following:

- a. The protecting structure for a protected shaft, containing mechanical ventilation ducts serving areas specified in *Cl.5.2.1g.(1)* and *Cl.5.2.1h.* or kitchen exhaust ducts, which pass through floor slabs, shall be of masonry construction. Such a shaft shall be completely compartmented from the rest of the shaft space containing other ducts or any other services installations. A protected shaft containing ducts serving other areas which pass through floor slabs can be constructed of drywall. If the protected shaft is of drywall construction, the conditions stipulated in *Cl.3.8.7b.* shall be complied with.

b. Cavity barriers

A protected shaft used for the enclosure of electrical power services shall be interrupted at every floor level with at least ½-hr fire resistance cavity barriers. Protected shaft used for the enclosure of telecommunications services shall be interrupted by at least ½-hr fire resistance cavity barriers at vertical intervals not exceeding 15m. The cavity barriers within trunking enclosing electrical and telecommunication cables can be exempted if the following conditions are met:

- (1) the cables shall be flame retardant type complying with IEC 60332;
- (2) the floor within the shaft shall be sloped upward with an angle of at least 45° to the floor level; and
- (3) the fire doors to the protected shaft are installed with self-closing devices.

c. **Self-closing devices**

Automatic self-closing devices are not required to be installed on fire resisting doors opening into protected shafts which are interrupted by at least ½-hr fire resistance cavity barriers at every floor level, or protected shafts containing sanitary pipes or water pipes, provided that the fire resisting doors are kept closed and locked at all times.

d. **Siting of protected shafts**

All protected shafts containing services shall not be located within an exit staircase except for the case of residential apartment/maisonette development under PG II not exceeding 4-storey where smoke-stop lobby is not required.

3.9 PROTECTION OF OPENINGS

3.9.1 Application

The provisions of this Clause concern the protection of openings permitted in elements of structure or other forms of fire resisting construction, which are required to act as a barrier to fire and smoke.

3.9.2 Fire doors

Fire doors for protection of openings shall comply with all of the following:

- a. Fire doors shall have the appropriate fire resistance as required by relevant parts of the Code. A two-leaf doors can be used if the door achieves the required level of fire resistance.
- b. All fire doors shall be fitted with an automatic self-closing device which is capable of closing the door from any angle and against any latch fitted to the door. The omission of a self-closing device to the bolted door leaf of a two-leaf door is acceptable if the door is the entrance door to a residential unit under PG II.
- c. Where a self-closing device would be considered a hindrance to the normal use of the building, fire doors can be held open as follows:
 - (1) by a fusible link, or
 - (2) by electromagnetic or electromechanical devices which can be activated via smoke detector and/or the building alarm system.
- d. Any hinge on which a fire door is hung shall be of the approved type, complying with SS 332.
- e. Any fire door fitted in an opening which is provided as a means of escape:
 - (1) shall be capable of being opened manually, without the use of key, tool, special knowledge or effort for operation from the inside of the building;

- (2) shall not be held open by any means other than by an electromagnetic or electromechanical device which can be activated via smoke detector and/or the building alarm system, except in the case of fire doors opening into pressurised exit staircases; and
 - (3) shall open in the direction of exit travel in accordance with *Cl.2.3.9*.
- f. Fire doors, where required, shall be constructed and installed to comply with specifications stipulated under SS 332.

3.9.3 Pipes

- a. Pipes passing through a separating wall, compartment wall or compartment floor shall be kept as small as possible and be fire-stopped around the pipe. The nominal diameter of the pipe shall not be more than the respective dimension given in *Table 3.9A*. These pipe penetrations are permitted only for conveying non-hazardous & non-combustible substances such as air, water, etc., and approved fire-stopping material shall be applied around the pipe penetration. The clear spacing between pipes shall be at minimum 50mm or half the diameter of the largest pipe, whichever is larger.
- b. The following pipes of nominal diameter larger than 150mm, subject to the conditions listed under *Cl.3.9.3c*. below, are permitted to penetrate through a separating wall, compartment wall or compartment floor:
 - (1) emergency standby diesel generator steel exhaust pipes connected directly to the external space;
 - (2) pipes of non-combustible material (such as cast iron or steel) with pipe wall thickness of at least 5mm, and melting point of at least 1200°C; and
 - (3) thermal insulated pipes with pipe wall thickness of at least 5mm and combustible insulation in compliance with *Cl.7.1.2c.(1)*. The metal sheath for insulation material shall be at least 0.6mm thick galvanised steel with the melting point, including pipe support, of at least 1200°C.
- c. The following conditions shall be complied with for penetration of pipes stipulated under *Cl.3.9.3b*.:
 - (1) For non-sprinkler-protected area, pipe supports within 3m from the pipe penetration shall be strengthened such that the tensile stress generated on the supports shall not exceed 10N/mm² and will not be softened or fracture when exposed to temperature of 750°C. For sprinkler-protected area, the pipe supports and pipe penetrations shall be protected by the sprinkler system;
 - (2) Combustible materials or services (e.g. pipe or ductwork) are not permitted to be placed within 1m before and after the penetration [except for those thermal insulated pipes constructed under *Cl.3.9.3b.(3)*]. For the purpose of this sub-clause, fire-rated materials are deemed as non-combustible; and

- (3) The penetration shall not pass through fire-rated wall/floor of exit staircase, fire lift lobby, smoke-stop lobby, electrical switch room, transformer room, generator room, battery room and fan room serving fire protection system, fire pump room, FCC, fuel tank room, and areas handling hazardous materials. Except for exit staircase, the penetration of pipes through the abovementioned rooms/spaces is permitted if the pipes are fully enclosed by fire-rated enclosure with the same fire-rating as the fire-rated walls/floors it passes through.
- d. In addition to *Cl.3.9.3a.*, fuel and vent pipes for emergency standby diesel generators and fuel tanks located outside the room they served shall be enclosed in construction having at least 2-hr fire resistance rating. They shall not be located in intakes/fresh air vent shafts.
 - e. **Routing of gas pipes in basements**
 - (1) All gas pipes that are routed in basement shall be API pipes with welded joints. These joints shall be 100% radiography checked in accordance with SS 608. The gas pipes are not required to be fire-rated if they are running outside essential areas such as an exit staircases, smoke-stop or fire lift lobby, fire pump room, generator room, FCC, etc.. If gas pipes run pass through an essential area, they are required to be encased in masonry.
 - (2) For mechanically ventilated basement, the gas pipes shall be provided with pipe sleeves to vent the gas pipes. One end of the sleeve shall be exposed to the external space in accordance with SS 608.
 - (3) For naturally ventilated basement that complies with *Cl.6.4.1d.(2)(b)(ii)*, the provision of pipe sleeve is not required.

3.9.4 Ventilation ducts

A ventilation duct which passes directly through a compartment wall or compartment floor shall comply with the following:

- a. Where the ventilation duct does not form a protected shaft or is not contained within a protecting structure,
 - (1) the duct shall be fitted with a fire damper where it passes through the compartment wall or compartment floor; and
 - (2) the opening for the duct shall be kept as small as practicable and any gap around the fire damper shall be fire-stopped.
- b. Where the ventilation duct forms a protected shaft or is contained within a protecting structure, the duct shall be:
 - (1) fitted with fire dampers at the inlets to the shaft and outlets from it; and
 - (2) constructed and lined with materials in accordance with the requirements in Chapter 7.

- c. The installation of ventilation ducts and fire dampers shall comply with the requirements in Chapter 7.

3.9.5 Flues

Ducts encasing one or more flue pipes which pass through a compartment wall or compartment floor shall be of non-combustible construction, having fire resistance of not less than half the minimum period of fire resistance required for the compartment wall or compartment floor through which it passes, except for kitchen flue pipes when the fire resistance shall be as required for the compartment wall or compartment floor.

3.9.6 Services passing through FCC, fire pump room, emergency generator room and smoke control fans room

Air ducts, sanitary pipes, gas pipes, electrical conduits/cable tray and other services that are likely to permit the passage of flame or smoke in the event of a fire shall not be permitted to pass through any of the following spaces:

- a. FCCs
- b. Fire pump rooms
- c. Emergency generator rooms
- d. Smoke control fans rooms

except where such services are required for the operation of the equipment in these areas.

3.9.7 Services running inside and/or passing through fire lift lobby and smoke-stop lobby

Air ducts, sanitary pipes, gas pipes, electrical conduits/cable tray, and other services, excluding lifts shall not be permitted to run inside and/or pass through:

- a. fire lift lobbies, or
- b. smoke-stop lobbies.

unless all these services are protected with a 1-hr fire resistance rating enclosure, or separated with a 1-hr fire resistance ceiling from the said lobby. If these services are required for the operation of the above lobbies, they need not be separately protected. However, this requirement need not be complied with if the smoke-free approach is through an external corridor.

3.9.8 Gas pipes running inside an internal corridor/lobby

Gas pipes running inside an internal corridor/lobby without fire resistance enclosure shall be encased with a pipe duct/sleeve vented to an external space.

CHAPTER 03

3.10 EXIT STAIRCASES

3.10.1 Non-combustibility of structure

Every exit staircase, including the treads/risers and landing, shall be constructed of non-combustible materials. The exception is for buildings under PG I, where only the stringer or structures supporting the treads/risers and landing shall be constructed of non-combustible materials.

3.10.2 Compartmentation

The exit staircase shall be separated from other parts of the building by a masonry structure or drywall complying with *Cl.3.8.7b*, which shall have fire resistance for not less than the period required by *Cl.3.3* for elements of structure.

3.10.3 Exit doors

Doors opening into the exit staircase shall have at least ½-hr fire resistance rating and fitted with an automatic self-closing device.

3.10.4 Finishes

Finishes to the ceilings/walls and floors of exit staircase shall be of non-combustible materials.

3.11 CONCEALED SPACES

3.11.1 General provision

Concealed spaces in a building, such as those within suspended ceilings or raised floors, shall be sub-divided by construction of cavity barriers to restrict the spread of smoke and flames.

3.11.2 Closing the edges of cavities

Cavity barriers shall be used to close the edges of cavities, edges around openings through a wall, floor and any other part of the construction which contains a cavity and to separate any cavity in a wall, floor or any other part of the construction from any other such cavity.

3.11.3 Interrupting cavities

If a fire-resistant barrier (such as a compartment wall, floor, ceiling or roof) abuts a cavity (including a roof space), such a barrier shall be extended to sub-divide the cavity to form a complete fire resistant barrier. Such cavity barriers shall be of fire resisting construction at least equal to the provision for that required of the fire resisting barrier.

3.11.4 Sub-division of extensive cavities

Cavities, including roof spaces, unless otherwise permitted, shall be sub-divided so that the maximum distance between cavity barriers shall not exceed the relevant dimensions given under [Table 3.11A](#).

3.11.5 Fire resistance and fixing of cavity barriers

Cavity barriers shall be:

- a. constructed to provide at least ½-hr fire resistance rating; and
- b. tightly fitted to rigid construction or the junctions shall be fire-stopped to comply with the requirements of [Cl.3.12](#).

3.11.6 Openings in cavity barriers

A cavity barrier shall have no opening except for:

- a. a door which has the same fire resistance rating as the cavity barrier, and are kept closed all the times;
- b. a pipe which complies with the provision under [Cl.3.9.3](#);
- c. a cable or conduit containing one or more cables;
- d. a duct which is fitted with suitably mounted automatic fire damper where it passes through the cavity barrier; and
- e. other openings fitted with a suitably mounted fire damper.

3.11.7 Raised floors for fixed stages and display platforms

The construction of raised floors for fixed stages and display platforms shall comply with the following requirements:

- a. the concealed space between the structural floor and raised floor shall not be used for storage;
- b. no services or installation shall be permitted within the concealed space other than electrical wiring in conduit in compliance with the requirements of SS CP 5;
- c. all sides of the raised floor shall be properly sealed; and
- d. the concealed space shall be subdivided by cavity barriers in compliance with the requirements of [Cl.3.11.4](#) and [Table 3.11A](#).

3.11.8 Raised floors with or without accessible panels

The construction of raised floors with or without accessible panels shall comply with all of the following requirements:

- a. The supporting structure shall be constructed of non-combustible materials

having a melting point of at least 750°C.

- b. The concealed space between the structural floor and raised floor shall not be used for storage.
- c. No services or installations shall be permitted within the concealed space other than:
 - (1) electrical wiring in metal conduit and metal trunking in compliance with the requirements of SS CP 5;
 - (2) communication cables for computer equipment; and
 - (3) fire protection installations serving the area.
- d. Where the raised floor is used as a plenum, requirements in [Cl.7.1.4](#) shall be satisfied.
- e. Decking of the raised floor shall be constructed of non-combustible material. Where combustible material is used as core material, if allowed in the case of sprinkler-protected buildings, the top, bottom, all sides and cut edges shall be covered with material with surface property complying with Class 0 (excluding materials for floor finishes).
- f. In the case of raised floors with accessible panels, access sections or panels shall be provided such that all concealed spaces between the structural floor and raised floor are easily accessible.
- g. Openings in the raised floor for entry of electrical cables shall be effectively closed to prevent entry of debris or other combustible material into the concealed spaces.
- h. All sides of the raised floor shall be properly sealed.
- i. the concealed space shall be subdivided by cavity barriers such that the maximum unobstructed area within the concealed space does not exceed 930m².
- j. Where the concealed space is fitted with an automatic sprinkler system which complies with the requirements in Chapter 6, cavity barriers are not required.
- k. For a non-sprinkler-protected building, if the height of the concealed space measured between the top of the structural floor and underside of the raised floor decking exceeds 150mm, it shall be fitted with an automatic smoke detection system complying with requirements of SS CP 10. For a sprinkler-protected building, the concealed space shall be fitted with an automatic smoke detection system as above if its height is between 150mm to 400mm, and automatic sprinkler system if it exceeds 400mm; and
- l. Where the height of concealed space measured between the top of the structural floor and the underside of the raised floor decking is less than 50mm, the requirements on provision of cavity barriers shall not be applicable.

3.11.9 Provision for concealed spaces between floor or roof and suspended ceilings

Provision of cavity barriers within the concealed spaces of suspended ceiling can be exempted provided all of the following requirements are complied with:

- a. The concealed space shall not be used for storage.
- b. The supporting elements shall be constructed of non-combustible material.
- c. The exposed surfaces within the concealed space is of Class 0 flame spread (excluding surfaces of any pipe, cable, conduit or insulation of any pipe).
- d. In the case of a detector protected building:
 - (1) if the concealed space does not exceed 800mm in depth, or
 - (2) if the concealed space is fitted with detectors which comply with the requirements of Chapter 6.
- e. In the case of a sprinkler-protected building:
 - (1) if the concealed space does not exceed 400mm in depth, or
 - (2) if the concealed space exceeds 400mm and does not exceed 800mm in depth and no combustible material is used within the concealed space, or
 - (3) if the concealed space is fitted with an automatic sprinkler system which complies with the requirements of Chapter 6.
- f. In the case of other buildings, the concealed space shall not exceed 800mm in depth.

3.11.10 Exemption of cavity barriers in ceiling space

Where the concealed space of suspended ceiling is fitted with an automatic sprinkler system which complies with the requirements in Chapter 6,

- a. the concealed space can be exempted from provision of cavity barriers; and
- b. combustible materials can be used for the supporting elements and exposed surfaces of materials within the concealed space, provided the ceiling is not situated over an exit passageway, smoke-stop lobby or other designated means of escape facilities.

3.11.11 Suspended ceiling over protected areas

The concealed spaces of a suspended ceiling over an exit passageway, smoke-stop lobby, exit staircase or other designated means of escape facilities shall comply with the following:

- a. the ceiling supporting elements and the ceiling shall be constructed of non-combustible materials;

CHAPTER 03

- b. the exposed surfaces within the concealed space shall be of Class 0 surface flame spread; and
- c. where sprinkler system is installed within the concealed spaces at smoke-stop lobby/fire lift lobby, the ceiling supporting elements and its exposed surface may have a surface spread of flame not lower than Class 2.

3.11.12 Exemption

Buildings under PG I are not required to comply with the requirements on the provision of cavity barriers in concealed spaces. Residential units in buildings under PG II need not comply with requirements on the provision of cavity barriers in concealed floor and ceiling spaces.

3.12 FIRE STOPPING

3.12.1 General provision

Openings for pipes, ducts, conduits or cables which pass through any part of a compartment (except for a part which does not serve as a fire resisting barrier) or cavity barrier, shall be:

- a. kept as few in number as possible;
- b. kept as small as practicable; and
- c. all gaps shall be filled with fire-stopping materials.

3.12.2 Fire-stopping

Materials for fire stopping shall have the necessary fire resistance when tested to BS 476: Part 20 or other acceptable standards.

3.12.3 Materials for fire-stopping

Suitable fire-stopping materials include:

- a. Fire-stopping and sealing systems (including those designed for service penetrations) which have been shown by test to maintain the fire resistance of the wall or other element.
- b. Other fire-stopping materials include:
 - (1) cement mortar;
 - (2) gypsum-based plaster;
 - (3) cement or gypsum-based vermiculite/perlite mixes;
 - (4) glass fibre, crushed rock, blast furnace slag or ceramic based products (with or without resin binders); and

- (5) intumescent mastics.

The method of fire-stopping and choice of materials shall be appropriate to the situation and its application.

3.13 CLASSIFICATION OF SPREAD OF FLAME

3.13.1 Requirements for Class 0

Any reference to a surface being Class 0 shall be construed as a requirement that:

- a. the material of which the wall or ceiling is constructed shall be non-combustible throughout, or
- b. the surface material (or, if it is bonded throughout to a substrate, the surface material in conjunction with the substrate) shall have a surface of Class 1 when tested to BS 476 Part 7 and if tested in accordance with BS 476: Part 6 shall have an index of performance (I) not exceeding 12 and a sub-index (i_1) not exceeding 6.

3.13.2 Class other than Class 0

Any reference to a surface being of a class other than Class 0, shall be construed as a requirement that the material which the wall or ceiling is constructed shall comply with the relevant test criteria relating to surface spread of flame, which is specified in relation to that class in BS 476: Part 7.

3.13.3 Order of classification

Class 0 shall be regarded as the highest class (based on BS 476 Part 6 & 7), followed in descending order by Class 1, Class 2, Class 3 and Class 4 (based on BS 476 Part 7), as set hereunder:

- a. Class 0 - Surface of no flame spread. Such surfaces shall conform to the requirements of *Cl.3.13.1*.
- b. Class 1 - Surface of very low flame spread. This refers to surfaces on which during the first 1½ mins of test, the spread of flame does not exceed 165mm and the final spread of flame does not exceed 165mm under the relevant test conditions.
- c. Class 2 - Surface of low flame spread. This refers to surfaces on which during the first 1½ mins of test, the spread of flame does not exceed 215mm and the final spread of flame does not exceed 455mm under the relevant test conditions.
- d. Class 3 - Surface of medium flame spread. This refers to surfaces on which during the first 1½ mins of test, the spread of flame does not exceed 265mm and the final spread of flame does not exceed 710mm under the relevant test conditions.

- e. Class 4 - Surface of rapid flame spread. This refers to surfaces on which the spread of flame exceeded the limit of Class 3.

3.13.4 Class of flame spread to be not lower than specified

The surface of a wall or ceiling in a room/space shall be of a class not lower than specified as relevant in the [Table 3.13A](#), provided that

- a. Where an automatic sprinkler system is fitted throughout in the building in compliance with the requirements in Chapter 6, there is no control on the surface of flame rating in rooms/spaces, except for the following occupancies/usage:
 - (1) healthcare facilities, including hospital, and nursing homes for handicapped, disabled, aged or persons with mental and / or mobility impairments;
 - (2) detention facilities; and
 - (3) exit staircases, exit passageways and smoke-stop / fire lift lobbies.
- b. Where a building is not protected by an automatic sprinkler system, surfaces of the walls and ceilings can be of a surface class not lower than Class 3 to the extent permitted by *Cl.3.13.5a.* and *Cl.3.13.5b.* respectively.
- c. If timber is used as the surface material for the walls along the side gangways of an auditorium which is not sprinkler-protected, the requirements of this regulation pertaining to the requisite class of flame spread can be relaxed only in respect of those parts of such wall surfaces provided the aggregate area of such parts does not exceed 50% of the whole surface area of the side walls of the auditorium.

3.13.5 Where class of flame spread can be of any class not lower than Class 3

- a. Any part of the surface of a wall in a room or compartment can be of any class not lower than Class 3 if the area of that part (or if there are two or more such parts, the total area of those parts) does not exceed the following
 - (1) in the case of a building or compartment of PG III, 20m², or
 - (2) in any other case, 60m².
- b. Any part of the surface of a ceiling can be of any class not lower than Class 3 if that part of the surface is the face of a layer of material the other face of which is exposed to the external air (skylight included) and complies with any one of the following:
 - (1) The ceiling is that of a room in a building or compartment of PG III, IV, V or VII, or is that of a circulation space excluding a smoke-stop lobby, exit staircase or exit passageway in a building or compartment of any purpose group, and

- (a) the area of that part does not exceed 2.5m²; and
 - (b) the distance between that part and any other such part is not less than 3.5m.
- (2) The ceiling is that of a room in a building or compartment of PG VI or VIII, and
- (a) the area of that part does not exceed 5m²;
 - (b) the distance between that part and any other such part is not less than 1.8m; and
 - (c) that part and all other such parts are evenly distributed over the whole area of the ceiling and together have an area which does not exceed 20% of the floor area of the room.
- (3) The ceiling is that of a balcony, verandah, open car porch, covered way or loading bay which (regardless of its floor area) has at least one of its longer sides wholly and permanently open.
- (4) The ceiling is that of a garage or outbuilding which (regardless of whether it forms part of a building or is a building which is attached to another building or wholly detached) has a floor area not exceeding 40m².

3.13.6 Exception

Wall and ceiling finishes in the form of thin sheet of not more than 1.0mm thickness mounted to a non-combustible substrate will not be subject to the requirement of surface spread of flame provisions, except for exit staircases and passageways.

3.13.7 Composite panel

Composite panel used as wall, ceiling or finishes shall comply with *Cl.3.15.13*.

3.14 ROOFS

3.14.1 Roof construction

- a. The surface of materials for roof covering and roof construction shall have a surface spread of flame rating not lower than Class 1, or Class A when tested in accordance with ASTM E108, except in the case of PG I and PG II, and in buildings that are protected throughout with automatic sprinkler system.
- b. Composite panel used as roof covering shall comply with *Cl.3.15.13*.
- c. Roof covering containing plastic shall comply *Cl.3.15.19c.(7)*.

3.14.2 Provision for buildings not exceeding four storeys

Combustible material can be used for roof construction for PG III, IV, V and VII buildings which satisfy the following requirements:

- a. the building shall not exceed four storeys;
- b. the roof space between the roof and the ceiling shall be sub-divided by cavity barriers where required to comply with the relevant provisions of *Cl.3.11*, and openings in cavity barriers shall be fire-stopped to comply with the requirements of *Cl.3.12*; and
- c. if the underside of the roof serves as the ceiling to a room or space, the elements of the underside of the roof shall comply with the relevant provisions of *Cl.3.13* for restriction of spread of flame.

3.14.3 Roof junction with separating wall and compartment wall

At junctions where the roof meets with a separating wall or compartment wall, the roof construction shall comply with the relevant requirements under *Cl.3.6.3* and *Cl.3.7.4* respectively.

3.15 MATERIALS FOR CONSTRUCTION

3.15.1 General

Materials used in the construction of building elements shall comply with the provisions stated under this section in addition to the performance requirements, such as fire resistance rating and limit to spread of flame, stipulated in other relevant sections of this Code.

3.15.2 Intumescent paint

Intumescent paint is allowed to be used for protection of structural steel members of all buildings provided all of the following requirements are complied with:

- a. The paint shall be of a proprietary system that has been demonstrated to achieve the fire resistance performance as required in BS 476 Part 20/21 or its equivalent, together with the specified weathering tests as specified in the BS 8202: Part 2.
- b. Coating of intumescent paint onto structural steels, and subsequent maintenance shall conform to BS 8202: Part 2. Fire test for fire resistance performance shall be conducted on the specimens after the weather tests. The fire resistance rating of the tested specimen shall not diminish more than 25%, post-weathering tests.
- c. A signage depicting the below minimum information shall be affixed at a conspicuous location:
 - (1) Name of supplier

- (2) Fire resistance rating of the intumescent paint
 - (3) Date of painting
 - (4) Expected date of re-painting
 - (5) Caution note: "Caution – No other paint/coating shall be applied to the surfaces of the structural steel members protected by the intumescent paint system"
- d. In buildings under PG VI and VIII, where there can be presence of corrosive atmosphere that can affect the effectiveness of intumescent paints for protection to structural steel members of buildings, such proposal shall be subjected to evaluation of the SCDF.

3.15.3 Flame retardant chemicals

Flame retardant chemicals can be used for upgrading of fire resistance rating or surface spread of flame of timber or any combustible materials, subject to the following:

- a. the chemical treatment process is part of the manufacturing process to produce the finished product;
- b. the chemical treatment is by means of pressure impregnation conforming to SS 572, or the manufacturer's specification in accordance to the prototype test, for timber and other combustible materials respectively; and
- c. the treated materials/products have been subjected to a fire test, as required under *Cl 3.4.1* or *Cl 3.13.1*.

3.15.4 Elements of structure

All elements of structure shall be constructed of non-combustible materials in addition to the relevant provisions as follows:

- a. *Cl.3.3* for fire resistance of elements of structure
- b. *Cl.3.5.1*, *Cl.3.5.2* & *Cl.3.5.4* for external walls
- c. *Cl.3.6.1a.(3)*, *Cl.3.6.1b.* & *Cl.3.6.5* for separating walls
- d. *Cl.3.7.1c.*, *Cl.3.7.1d.*, *Cl.3.7.5* & *Cl.3.7.6* for compartment walls and compartment floors
- e. *Cl.3.8.2c.*, *Cl.3.8.4*, *Cl.3.8.7b.*, *Cl.3.8.8b.*, *Cl.3.8.8e.* and *Cl.3.8.9a.* for protected shafts

3.15.5 Protection of openings

Materials used for the protection of openings shall comply with the relevant provisions of *Cl.3.9* of this Code for protection of openings.

CHAPTER 03

3.15.6 Exit staircases

Exit staircases shall be constructed of non-combustible materials to comply with the provisions of *Cl.3.10.1*.

3.15.7 Raised floors

Materials used for the construction of raised floors shall comply with the provisions of *Cl.3.11.8a*. and *Cl.3.11.8e*.

3.15.8 Ceiling and ceiling supports

- a. Materials used for construction of ceiling and its supports shall comply with *Table 3.13B*, except for supports that are required to comply with *Cl.3.11.9b*.
- b. Construction of ceilings and ceiling supports located within sprinkler-protected building shall comply with the provision of *Cl.3.11.10b*.

3.15.9 Fire-stopping

Materials used for fire-stopping shall comply with the relevant provisions of *Cl.3.12.2* and *Cl.3.12.3*.

3.15.10 Surfaces of walls and ceilings

Materials used on the surfaces of walls and ceilings are required to meet the requirements for restriction of spread of flame, and shall comply with the performance requirements as stipulated under *Cl.3.13*.

3.15.11 Roof construction

Materials used for roof construction shall comply with the provisions of *Cl.3.14.1* & *Cl.3.14.2*.

3.15.12 Internal non-load-bearing walls

Internal non-load-bearing walls in buildings shall comply with *Table 3.13B* and the materials for surface finishes of internal non-load-bearing walls shall not be treated as part of the wall and shall comply with the relevant provisions of *Cl 3.13*.

3.15.13 Composite panel

Composite panels used for the construction of internal non-load-bearing walls, as cladding to external/internal walls or as roof covering shall comply with all of the following criteria:

- a. The outer layers shall be constructed of non-combustible material.
- b. The core material (with aggregate thickness exceeding 1mm) of composite panel used for building interior shall meet the classification stipulated in *Table 3.13B*.

- c. The composite panel used for external wall cladding shall be mounted against 1-hr fire-rated wall and shall comply with any of the following:
 - (1) Its core material shall meet at least:
 - (a) BS 476 Pt 4, or
 - (b) BS 476 Pt 11, or
 - (c) Class 0 flame-spread rating when tested in accordance with BS 476 Pt 6 & 7, or
 - (d) Class B classified under EN 13501-1.
 - (2) The panel assembly shall comply with NFPA 285.
- d. Composite panel containing plastic shall also comply with *Cl.3.15.19*.

3.15.14 Fire-rated glass

In buildings which are protected by an automatic sprinkler system, fire-rated glass can be used for the construction of compartment walls, compartment floors, enclosures of smoke-stop lobbies and fire lift lobbies, and protected shafts not containing exit staircase and fire lift, subject to the following:

- a. the walls and doors shall have the necessary fire resistance, including insulation, when subject to test under BS 476 Part 20-23; and
- b. the walls and doors shall meet the requirement of Class A for Impact Performance when tested under BS 6206 and EN 12600 or AS 2208.

3.15.15 Walls, ceilings, roof covering and finishes

Walls, ceilings, floor, roof and finishes shall not contain any plastic material, unless the plastic material complies with the requirements stipulated in *Cl.3.15.19*.

3.15.16 Separation of areas undergoing A&A works

For additions and alterations to existing buildings, non-combustible partitions shall be used for separation of areas undergoing A&A works from other occupied areas of the building.

3.15.17 Partition for toilet cubicles

Materials with surface flame spread rating of not lower than Class 2 shall be used for the construction of partition for toilet cubicles. If the material used is of Class 3 surface flame spread rating, total exposed surface area of the partitions within the toilet shall not be more than 60m².

3.15.18 Timber floors

The use of timber floors is allowed under the following situations, provided it is protected to achieve the fire resistance rating required of the elements of structure or

compartment:

- a. for an attic in buildings under PG I and II, or
- b. in buildings designated for conservation where the timber floors are required to be retained, but subject to compliance with requirements stipulated under [Cl.9.9.1](#), or
- c. in buildings built before 1969 under [Cl.9.9.1](#).

3.15.19 Use of plastics in building construction

a. **General**

- (1) [Tables 3.15A](#), [3.15B](#) and [3.15C](#) list the relevant fire test standards and acceptance criteria concerning the use of plastics for various building applications. [Tables 3.15D](#) to [3.15K](#) stipulate whether fire tests are exempted or required, depending on the situation, as well as the situations in which the use of plastics is disallowed regardless of the fire test results. The use plastics for wall, ceiling, roof covering, floor and related finishes is only allowed if the conditions stated are met.
- (2) For each test category, only one fire test is needed to demonstrate the acceptable fire risk level.
- (3) Fire retardants are also allowed to be used to enhance the fire performance of plastics for building construction provided the retardants are applied in suppliers' factories according to the retardants' respective standards. Accelerated weathering tests will also be required to assess the effect of weather on fire retardants applied on external building applications.

b. **Acceptable fire tests and corresponding acceptance criteria**

- (1) For plastic floor material/finishes, see [Table 3.15A](#).
- (2) For plastic wall and ceiling material/finishes, see [Table 3.15B](#).
- (3) For plastic roof covering, see [Table 3.15C](#).

c. **Conditions for the use of plastics in various building applications**

- (1) For plastic floor finishes (uncovered), see [Diagram 3.15.19c.\(1\)](#) and [Table 3.15D](#).
- (2) For plastic material cast into (embedded within) structural floor system, see [Diagram 3.15.19c.\(2\)](#) and [Table 3.15E](#).
- (3) For of plastic floor finishes (covered), see [Diagram 3.15.19c.\(3\)](#) and [Table 3.15F](#).
- (4) For plastic wall or ceiling material/finishes, see [Diagram 3.15.19c.\(4\)](#) and [Table 3.15G](#).
- (5) For composite panel containing plastic used as wall or ceiling material/finishes, see [Diagram 3.15.19c.\(5\)](#) and [Table 3.15H](#).

- (6) For plastic material embedded in masonry wall/ceiling, see *Diagram 3.15.19c.(6)* and *Table 3.15I*.
- (7) For plastic roof covering, see *Table 3.15J*.
- (8) For composite panel containing plastic used as roof covering, see *Table 3.15K*.

3.15.20 UPVC window frame

Window frames made partly or wholly of UPVC are allowed to be used in buildings provided they are listed under the product listing scheme and comply with the requirements stipulated in *Table 3.15.20*.

TABLE 3.15.20 : CONDITIONS OF INSTALLATION OF UPVC WINDOW FRAME					
Building type	Installation height (measured from the level of fire engine accessway/access road)		Length of window	Length of masonry wall break between windows	
	Non-sprinkler-protected	Sprinkler-protected		Horizontal	Vertical
PG I	No restriction				
PG II	≤ 60m	No restriction	≤ 3m	≥ 1m	≥ 1.5m
PG III & VII	≤ 15m	≤ 24m	≤ 3m	≥ 1m	≥ 1.5m
PG IV, V, VI & VIII	≤ 15m	≤ 24m	≤ 5m	≥ 1m	≥ 1.5m

TABLE 3.2A : SIZE LIMITATION OF BUILDING & COMPARTMENT		
Compartments (1)	Maximum Floor Area (2)	Maximum Cubical Extent (3)
<p>Compartment below ground level (No compartment shall comprise more than one storey)</p>	2000m ²	7500m ³
<p>Compartments between average ground level and a height of 24m (No compartment shall comprise more than 3 storeys)</p>	4000m ²	15000m ³
<p>Compartments above a height of 24m from average ground level (No compartment shall comprise more than one storey)</p>	2000m ²	7500m ³

TABLE 3.3A : MINIMUM PERIODS OF FIRE RESISTANCE

Note :

In this Table -

“cubical extent” means the cubical extent of the building or, if the building is divided into compartments, the compartment of which the elements of structure forms part;

“floor area” means the floor area of each storey in the building or, if the building is divided into compartments, of each storey in the compartment of which the element of structure forms part;

“height” has the meaning assigned to that expression by *Cl.3.3.1b.*;

“NL” means No limit applicable.

“NR” means Not Relevant.

PART I : BUILDINGS OTHER THAN SINGLE STOREY BUILDINGS

Purpose Group (1)	Maximum Dimensions			Minimum period of fire resistance for elements of structure (*)/external wall/ compartment wall forming part of :	
	Height ** (m) (2)	Floor Area (m ²) (3)	Cubical Extent (m ³) (4)	Above ground Storey (hrs) (5)	Basement Storey (hrs) (6)
PG I - Small residential					
House having not more than 3 storeys	NL	NL	NL	1	1
House having 4 storeys	NR	250	NR	1	1
	NL	NL	NL	1	2
House having more than 4 storeys	NL	NL	NL	1	2
PG II - Other residential					
Building or part (+) having not more than 2 storeys	NL	500	NR	1	1
	NL	NL	NL	1	2
Building or part (+) having 3 storeys	NR	250	NR	1	1
	NL	NL	NL	1	2
Building having more than 3 storeys	28	3000	8500	1	2
	NL	NL	NL	2	2
PG III - Institutional	28	2000	NL	1	1
	NL	NL	NL	2	2
PG IV - Office	15	NL	3500	1	1
	28	5000	14000	1	2
	NL	NL	NL	2	2

TABLE 3.3A : MINIMUM PERIODS OF FIRE RESISTANCE (cont'd)

PART I : BUILDINGS OTHER THAN SINGLE STOREY BUILDINGS					
Purpose Group (1)	Maximum Dimensions			Minimum period of fire resistance for elements of structure (*)/external wall/compartment wall forming part of :	
	Height ** (m) (2)	Floor Area (m ²) (3)	Cubical Extent (m ³) (4)	Above ground Storey (hrs) (5)	Basement Storey (hrs) (6)
PG V - Shop	15	NR	3500	1	1
	28	1000	7000	1	2
	NL	NL	NL	2	4
PG VI - Factory	15	NR	4250	1	1
	28	NR	8500	1	2
	NL	NL	NL	2	4
PG VII - Place of public resort	15	NR	3500	1	1
	28	1000	7000	1	2
	NL	NL	NL	2	2
PG VIII - Storage and general	15	NR	1700	1	1
	15	NR	3500	1	2
	28	NR	7000	2	4 ^(b)
	NL	NL	NL	4 ^(a)	4 ^(b)

Notes to Part I

For the purpose of [Cl 3.3.2](#) the period of fire resistance to be taken as being relevant to an element of structure is the period included in columns (3) or (4) in the line of entries which specifies the floor area with which there is conformity or, if there are two or more such lines, in the topmost of those lines.

(*) = A floor which is immediately over a basement storey shall be deemed to be an element of structure forming part of a basement storey.

(**) = Height for elements of structure referred to building height including basement. In the case of compartment wall/external wall, the height shall be based on the height of the wall between compartment floors.

(+) = The expression “part” means a part which is separated as described in [Cl.3.3.1b](#)..

(a) = This period is reduced to 2-hrs for:
 (1) non-sprinkler-protected, open-sided standalone car park buildings
 (2) sprinkler-protected, above-ground car park floors in standalone car park building or sprinkler-protected mixed-use building.

(b) = Single basement car park storey, which is sprinkler-protected, the element of structure can be reduced to half the minimum period of fire resistance.

TABLE 3.3A : MINIMUM PERIODS OF FIRE RESISTANCE (cont'd)

PART 2 - SINGLE STOREY BUILDINGS		
Purpose Group	Maximum Floor Area	Minimum period of fire resistance for elements of structure, external wall/compartment wall
(1)	(m²)	(hrs)
	(2)	(3)
PG I - Small residential	NL	1
PG II - Other residential	NL	1
PG III - Institutional	NL	1
PG IV - Office	NL	1
PG V - Shop	3000	1
	NL	2
PG VI - Factory	3000	1
	NL	2
PG VII - Place of public resort	3000	1
	NL	2
PG VIII - Storage and general	1000	1
	3000	2
	NL	4 ^(a)

Notes to Part 2:

For the purpose of *CI 3.3.2* the period of fire resistance to be taken as being relevant to an element of structure is the period included in column (3) in the line of entries which specifies the floor area with which there is conformity or, if there are two or more such lines, in the topmost of those lines.

(a) = This period is reduced to 2-hrs for open-sided buildings which are used solely for car parking.

TABLE 3.3B : REQUIREMENTS FOR SUSPENDED CEILING

Height of Building (1)	Type of Floor (2)	Required Fire Resistance of Floor (3)	Description of Suspended Ceiling (4)
Less than 15m	Non-compartment	1-hr or less	Surface of ceiling exposed within the cavity not lower than Class I surface flame spread rating.
	Compartment	Less than 1-hr	
	Compartment	1-hr	Surface of ceiling exposed within the cavity not lower than Class 0 surface flame spread rating; supports and fixing for the ceiling non-combustible.
	Any	More than 1-hr	Ceiling of non-combustible construction and jointless; supports and fixings for the ceiling non-combustible.
15m or more	Any	1-hr or less	Surface of ceiling exposed within the cavity not lower than Class 0 surface flame spread rating and jointless; supports and fixing for the ceiling non-combustible.
	Any	More than 1-hr	Ceiling of non-combustible construction and jointless; supports and fixings for the ceiling non-combustible

Note:

References to classes in the above table are to classes as specified in [Cl.3.13](#).

Where the space above a suspended ceiling is protected by an automatic sprinkler system it shall be exempted from the requirements for non-combustibility and surface spread of flame classification as specified in the above table provided the ceiling is not situated over an exit passageway, protected lobby or other required protected means of escape.

TABLE 3.4A : SPECIFIC PROVISIONS OF TEST FOR FIRE RESISTANCE OF ELEMENTS OF STRUCTURE ETC.

Part of Building	Minimum Provisions when Tested to BS 476: Part 20-23 (mins)			Method of Exposure
	Stability	Integrity	Insulation	
1. Structural frame, beam or column	*	No requirement	No requirement	exposed faces
2. Load-bearing wall Load-bearing wall which is not also an external wall, separating wall, compartment wall or protecting structure (See 4, 5, 6 or 7)	*	No requirement	No requirement	each side separately
3. Floors				
(a) floor in upper storey of a 2-storey dwelling house (but not over a garage)	30	15	15	from underside (Note 1)
(b) any other floor (including a compartment floor)	*	*	*	from underside (Note 1)
4. External walls				
(a) any part less than 1m from point on relevant boundary	*	*	*	each side separately
(b) any part of the wall of a building used for Assembly purposes which is 1m or more from the relevant boundary and is described in Note 2	*	*	15	from inside
	(max. 60)	(max. 60)	(max. 60)	from outside
(c) any part 1 m. or more from the relevant boundary and is not a part described in (b) above	*	*	15	from inside
5. Separating wall	(min. 60)	(min.60)	(min. 60)	each side separately
6. Compartment wall	*	*	*	each side separately
7. Protecting structure (any part)	*	*	*	each side separately
8. Wall separating an attached or integral garage from a dwelling house	*	*	*	from garage side
9. Doors				
(a) in a separating wall	No provision	+(min. 60)	No provision***	each side separately when fitted in its frame
(b) in a compartment wall if it separates a flat or maisonette from a space in common use	No provision	30	No provision***	each side separately

TABLE 3.4A : SPECIFIC PROVISIONS OF TEST FOR FIRE RESISTANCE OF ELEMENTS OF STRUCTURE ETC.(cont'd)

Part of Building	Minimum Provisions when Tested to BS 476: Part 20-23 (mins)			Method of Exposure
	Stability	Integrity	Insulation	
(c) in a compartment wall or compartment floor not described in (b) above	No provision	+	No provision***	each side separately
(d) in a protecting structure situated wholly or partly above the level of the adjoining ground in a building used for flats, other residential, assembly or office purposes	No provision	30	No provision***	each side separately
(e) in a protecting structure not described in (d) above	No provision	** (min. 30)	No provision***	each side separately
(f) any other door (including a door in a cavity barrier and a door between a dwelling house and garage)	No provision	30	No provision***	each side separately when fitted in its frame
10. Casing around a drainage system	30	30	30++	from outside
11. Cavity Barriers				
(a) cavity barrier 1m x 1m or larger	30	30	15	each side separately
(b) any other cavity barrier	30	30	No provision	each side separately
(c) ceiling	30	30	30	from underside

Modifications

++ = No provision for insulation if the casing is more than 50mm from any pipe in the enclosure (except a pipe passing through the casing).

Notes

* = Period of fire resistance as specified.

+ = Period of fire resistance for the wall or floor in which the door is situated.

** = Half the period of fire resistance for the wall or floor in which the door is situated.

*** = This exemption does not apply to fire-rated glass door.

A suspended ceiling should only be relied on to contribute to the fire resistance of the floor if the ceiling meets the appropriate provisions given in *Table 3.3B*.

Any part of the wall which is 7.5m or less above the ground, or above a roof or any other part of the building to which people have access, if the building has 2 or more storeys.

TABLE 3.9A : MAXIMUM NOMINAL DIAMETER OF PIPES

Situation	Pipe material and maximum nominal diameter (mm)		
	Non combustible material ⁽¹⁾	Lead, aluminium or aluminium alloy, or UPVC ⁽²⁾	Any other material
When the pipes (include pipe supports) penetrate the structure enclosing a protected shaft which is not an exit stairway or lift shaft	150	100	40
Any other situation	150	100 (stack pipe) ^{(3),(4),(5)} 75 (branch pipe) ^{(3),(4),(5)}	40

Note:

(1) = A non-combustible material (such as for cast iron or steel pipes and the pipe supports with melting point of at least 1200°C) which if exposed to a temperature of 750°C will not soften nor fracture to the extent that flame or gases will pass through the wall of the pipe.

(2) = UPVC pipes complying with BS 4514 or EN 1329-1.

(3) = Within toilets, wash rooms or external corridors, maximum diameter of UPVC pipes can be increased to double the size given in the above table.

(4) = Within areas of fire risk, such as kitchens, and adjacent to escape routes, UPVC pipes shall be enclosed by construction having fire resistance rating of at least ½ hr.

(5) = Where the size of UPVC pipes exceeds that specified under this clause, approved fire collar shall be fitted at all positions where such pipes pass through constructions required to act as a barrier to fire spread.

TABLE 3.11A: MAXIMUM DIMENSIONS OF CAVITIES

Location of cavity	Purpose Group of building or compartment	*Class of surface exposed in cavity	Max. dimension in any direction
Between roof and ceiling	I & II	any	no limit
	others	any	20m
Any other cavity	any	Class 0	20m +
	any	any	8m +

Note:

* = excluding surface of any pipe, cable, conduit or insulation of any pipe

+ = shall not apply to raised floor under [Cl.3.11.8](#)

TABLE 3.13A : MINIMUM FLAME-SPREAD CLASSIFICATION OF FINISHES TO WALL, COLUMN, BEAM AND CEILING

Building Type	Non-sprinkler-protected Building						Sprinkler-protected Building											
	Room, compartment		Circulation space		Smoke-stop /fire lift lobby		Exit stair-case & exit passageway		Room, compartment		Circulation space		Smoke-stop /fire lift lobby		Exit stair-case & exit passageway			
	BS ⁽²⁾	EN ⁽²⁾	BS ⁽²⁾	EN ⁽²⁾	BS ⁽²⁾	EN ⁽²⁾	BS ⁽²⁾	EN ⁽²⁾	BS ⁽²⁾	EN ⁽²⁾	BS ⁽²⁾	EN ⁽²⁾	BS ⁽²⁾	EN ⁽²⁾	BS ⁽²⁾	EN ⁽²⁾		
PG I - Small residential	NA	NA	NA	NA	NA	NA	NA	NA	NA	NA	NA	NA	NA	NA	2	C	0	B
PG II - Other residential	NA	NA	0	B	0	B	NC	A2	NA	NA	NA	NA	NA	NA	2	C	0	B
PG III - Institutional	1	C	0	B	0	B	NC	A2	3	D ⁽¹⁾	3	D ⁽¹⁾	3	D ⁽¹⁾	2	C	0	B
PG IV - Office	1	C	0	B	0	B	NC	A2	NA	NA	NA	NA	NA	NA	2	C	0	B
PG V - Shop	1	C	0	B	0	B	NC	A2	NA	NA	NA	NA	NA	NA	2	C	0	B
PG VI - Factory	1	C	0	B	0	B	NC	A2	NA	NA	NA	NA	NA	NA	2	C	0	B
PG VII - Place of public resort	1	C	0	B	0	B	NC	A2	NA	NA	NA	NA	NA	NA	2	C	0	B
PG VIII - Storage	1	C	0	B	0	B	NC	A2	NA	NA	NA	NA	NA	NA	2	C	0	B

Note:
 NC = Non-combustible to comply with BS 476 Pt 4
 NA = Not Applicable
 (1) = Applies to detention facilities and healthcare, including hospital, old-aged homes, nursing homes for mentally or physically disabled patients
 (2) = BS/EN refers to the following test standards. Meeting an EN standard implies that the corresponding BS standard is complied with but not vice-versa.

EN 13501-1		BS 476	
Classification	Test Standards	Classification	Test Standards
Class A1	EN ISO 1182 + EN ISO 1716	Non-combustibility (NC)	BS 476 Pt 4
Class A2	[EN ISO 1182 or EN ISO 1716] + EN 13823	Limited combustibility (LC)	BS 476 Pt 11
Class B	EN 13823 + EN ISO 11925-2	Class 0	BS 476 Pt 6 & 7
Class C	EN 13823 + EN ISO 11925-2	Class 1	BS 476 Pt 7
Class C	EN 13823 + EN ISO 11925-2	Class 2	BS 476 Pt 7
Class D	EN 13823 + EN ISO 11925-2	Class 3	BS 476 Pt 7
Class F	EN ISO 11925-2	Class 4	BS 476 Pt 7

TABLE 3.13B : MINIMUM FLAME-SPREAD CLASSIFICATION OF MATERIAL CONSTRUCTION (HOMOGENEOUS)*

Building Type	Non-sprinkler-protected Building						Sprinkler-protected Building					
	Internal Non-load-bearing Wall and Ceiling			Roof ⁽⁵⁾ Covering, including Supports			Internal Non-load-bearing Wall and Ceiling			Roof ⁽⁵⁾ Covering, including Supports		
	Within Room, Compartment		Within Circulation Spaces ⁽⁶⁾	Within Room, Compartment		Within Circulation Spaces ⁽⁶⁾	Within Room, Compartment		Within Circulation Spaces ⁽⁶⁾	Within Room, Compartment		Within Circulation Spaces ⁽⁶⁾
	BS ⁽⁷⁾	EN ⁽⁷⁾	BS ⁽⁷⁾	EN ⁽⁷⁾	BS ⁽⁷⁾	EN ⁽⁷⁾	BS ⁽⁷⁾	EN ⁽⁷⁾	BS ⁽⁷⁾	EN ⁽⁷⁾	BS ⁽⁷⁾	EN ⁽⁷⁾
PG I - Small residential	NA	NA	NA	NA	NA ⁽²⁾	NA ⁽²⁾	EN ⁽⁷⁾	NA	NA	NA	NA	EN ⁽⁷⁾
PG II - Other residential	NA	NA	LC ⁽³⁾	A2	NA ⁽²⁾	NA ⁽²⁾	EN ⁽⁷⁾	NA	NA	NA	NA	EN ⁽⁷⁾
PG III - Institutional	0	B	LC ⁽³⁾	A2	1	C ⁽⁴⁾	EN ⁽⁷⁾	1	C ⁽¹⁾	0	B ⁽¹⁾	C ⁽¹⁾⁽⁴⁾
PG IV - Office	0	B	LC ⁽³⁾	A2	1	C ⁽⁴⁾	EN ⁽⁷⁾	2	C	1	C	2
PG V - Shop	0	B	LC ⁽³⁾	A2	1	C ⁽⁴⁾	EN ⁽⁷⁾	2	C	1	C	2
PG VI - Factory	0	B	LC ⁽³⁾	A2	1	C ⁽⁴⁾	EN ⁽⁷⁾	2	C	1	C	2
PG VII - Place of public resort	0	B	LC ⁽³⁾	A2	1	C ⁽⁴⁾	EN ⁽⁷⁾	2	C	1	C	2
PG VIII - Storage	0	B	LC ⁽³⁾	A2	1	C ⁽⁴⁾	EN ⁽⁷⁾	2	C	1	C	2

Note:

- (1) = Applies to detention facilities and healthcare, including hospital, nursing homes for handicapped, disabled, aged or persons with mental and/or mobility impairment.
- (2) = Roof support can be of timber construction. Any use of plastic material for roof shall comply with the requirements in [Cl.3.15.19c.\(8\)](#)
- (3) = Limited combustibility tested under BS 476 Part 11 or non-combustibility tested under BS 476 Part 4
- (4) = Composite panel complying with ASTM E108 Class A is also acceptable
- (5) = Applicable to composite panel roofing only. Refer to [Cl.3.14.1](#) for other roofing materials
- (6) = Including common corridor, passageway etc.
- (7) = BS/EN refers to the test standards shown in the Note to [Table 3.13A](#). Meeting an EN standard implies that the corresponding BS standard is complied with but not vice-versa.

NA = Not Applicable
 LC = Limited combustibility
 * = When composite panels are used for the construction, the minimum flame-spread classification shall be applicable to the core material of the panels

**FIRE TESTS AND ACCEPTANCE CRITERIA FOR
CONSTRUCTION MATERIALS CONTAINING PLASTIC**

TABLE 3.15A : PLASTIC FLOOR MATERIAL/FINISHES			
Test Category	Fire Risk	Applicable Fire Test Standards	Acceptance Criteria
A	Toxicity emission	BS EN 45545-2	CIT < 0.75
		EN ISO 5659-2	CIT < 0.75
B	Smoke density	EN 13501-1	Smoke classification : s1 rating.
		EN 14041	
		EN ISO 9239-1	
		ASTM E662	Smoke density, $D_{s,max} < 450$
		NFPA 258	
		EN ISO 5659-2	Smoke density, $D_{s,max} < 150$
C	Flame spread	EN 13501-1	1. <u>Sprinkler-protected premises</u> (a) Sleeping occupancy : Class C_{fi} or better (b) Non-sleeping occupancy : Class D_{fi} or better
		EN 14041	
		EN ISO 9239-1	
		ASTM E648	2. <u>Non-sprinkler-protected premises</u> (a) Sleeping occupancy : Class B_{fi} or better (b) Non-sleeping occupancy : Class C_{fi} or better
		NFPA 253	
		Critical Radiant Flux (CRF) > 0.45 W/cm ²	

**FIRE TESTS AND ACCEPTANCE CRITERIA FOR
CONSTRUCTION MATERIALS CONTAINING PLASTIC**

TABLE 3.15B : PLASTIC WALL/CEILING MATERIAL/FINISHES			
Test Category	Fire Risk	Applicable Fire Test Standards	Acceptance Criteria
D	Toxicity emission	BS EN 45545-2	CIT < 0.75
		EN ISO 5659-2	CIT < 0.75
E	Smoke density	EN 13501-1	1. Smoke classification to be of s1 rating 2. Flaming droplet classification to be d0 rating
		EN ISO 5659-2	VOF ₄ < 300 min
F	Flame spread	EN 13501-1	1. Internal wall finishes : to comply with <i>Cl</i> 3.13 2. External wall finishes : to comply with <i>Cl</i> 3.5
		BS 476	
		NFPA 285	To pass criteria in NFPA 285
<p><u>Note:</u> Test categories D and E are not required for external wall finishes</p>			

TABLE 3.15C : PLASTIC ROOF COVERING MATERIAL			
Test Category	Fire Risk	Applicable Fire Test Standards	Acceptance Criteria
G	Toxicity emission	Not critical. Generally exposed to external.	
H	Smoke density	EN 13501-1	1. Generally not critical if exposed to external. 2. If exposed as ceiling on the underside, then must meet requirements for ceiling (achieve s1-d0 rating).
J	Flame spread	EN 13501-5	Class B _{ROOF}
		BS 476-3	Class AA/AB/AC
		BS 476-6/7	Class 1
		ASTM E108	Class A

**CONDITIONS FOR THE USE OF
PLASTIC FLOOR FINISHES (UNCOVERED)**

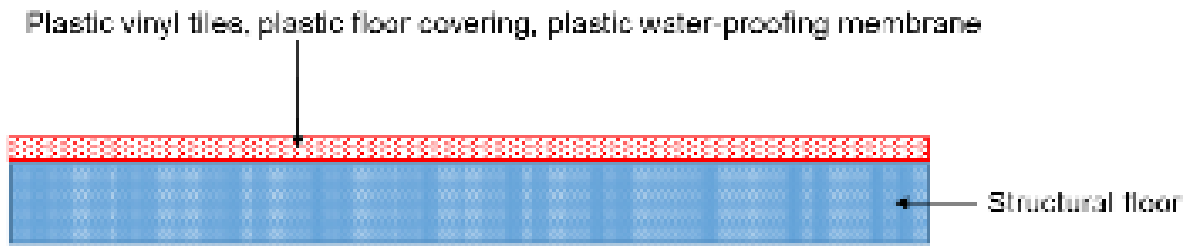

[Diagram 3.15.19c.\(1\) : Plastic floor finishes overlaid on structural floor](#)

TABLE 3.15D : UNCOVERED PLASTIC FLOOR FINISHES			
S/N	Material Construction	Assessment	Remarks
1	Non-combustible material	Allowed	No further fire test is required.
2	Material thickness not exceeding 10mm	Allowed	1. No further fire test is required. 2. For sprinkler-protected premises, material not exceeding 20mm can be exempted from the tests in <u>Table 3.15A</u> .
3	Use in open-to-sky conditions	Allowed	No further fire test is required.
4	Use in exit staircase/ exit passageways	Not allowed	Key escape routes shall be protected.
5	Material thickness exceeding 10mm	Allowed with conditions	Allowed if pass test categories A, B and C in <u>Table 3.15A</u> .

CONDITIONS FOR THE USE OF PLASTIC MATERIAL CAST INTO (EMBEDDED WITHIN) STRUCTURAL FLOOR SYSTEM

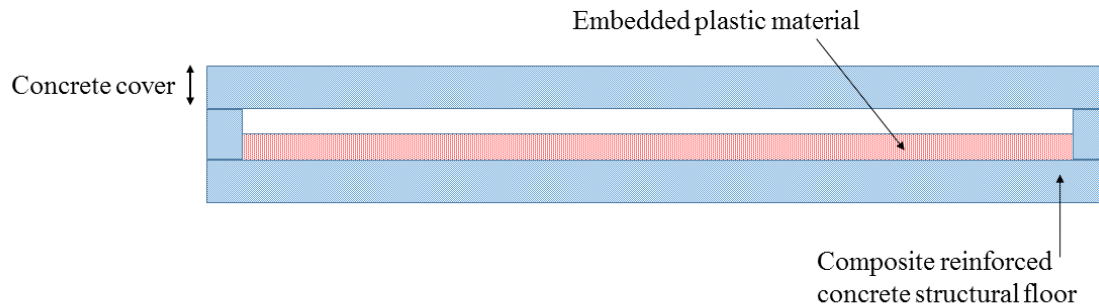

[Diagram 3.15.19c.\(2\) : Plastic material embedded within masonry floor](#)

TABLE 3.15E : PLASTICS EMBEDDED WITHIN MASONRY FLOOR			
S/N	Material construction	Assessment	Remarks
1	Non-combustible material	Allowed	No further fire test is required.
2	Material thickness not exceeding 10mm	Allowed	<ol style="list-style-type: none"> 1. No further fire test is required. 2. For sprinkler-protected premises, material not exceeding 20mm can be exempted from the tests in Table 3.15A.
3	Use in open-to-sky conditions	Allowed	No further fire test is required.
4	Use in exit staircase/ exit passageways	Not allowed	Key escape routes shall be protected.
5	Material thickness exceeding 10mm	Allowed with conditions	<ol style="list-style-type: none"> 1. If masonry cover is less than 25mm thick, the material shall pass test categories A, B and C in Table 3.15A. 2. If masonry cover is at least 25mm thick all around the embedded plastic, tests in Table 3.15A are exempted. 3. The locations where embedded plastics are installed shall be clearly indicated on the plans.

**CONDITIONS FOR THE USE OF
PLASTIC FLOOR FINISHES (COVERED)**

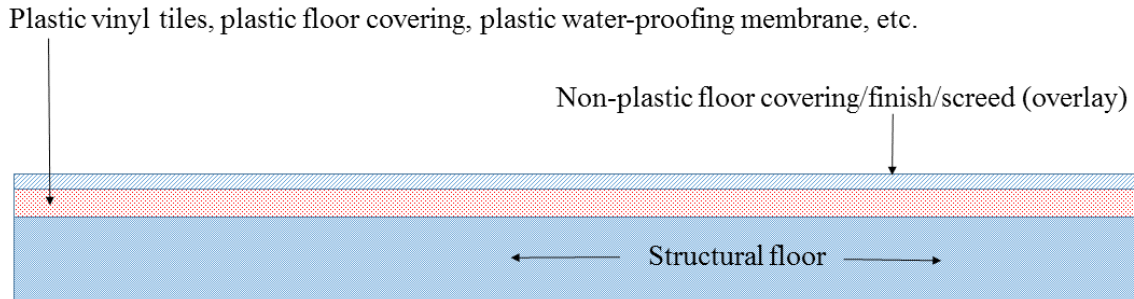

Diagram 3.15.19c.(3) : Plastic floor finishes laid on structural floor,
and covered by a non-combustible overlay

TABLE 3.15F : COVERED PLASTIC FLOOR FINISHES			
S/N	Material Construction	Assessment	Remarks
1	Non-combustible material.	Allowed	No further fire test is required.
2	Material thickness not exceeding 10mm	Allowed	1. No further fire test is required. 2. For sprinkler-protected premises, material not exceeding 20mm can be exempted from the tests in <u>Table 3.15A</u> .
3	Use in open-to-sky conditions.	Allowed	No further fire test is required.
4	Use in exit staircase / exit passageways	Not allowed	Key escape routes shall be protected.
5	Material thickness exceeding 10mm	Allowed with conditions	1. Allowed if pass test categories A, B and C in <u>Table 3.15A</u> . 2. If the overlay is non-combustible and at least 25mm thick, test category C in <u>Table 3.15A</u> is exempted

CONDITIONS FOR THE USE OF PLASTIC WALL FINISHES OR CEILING FINISHES

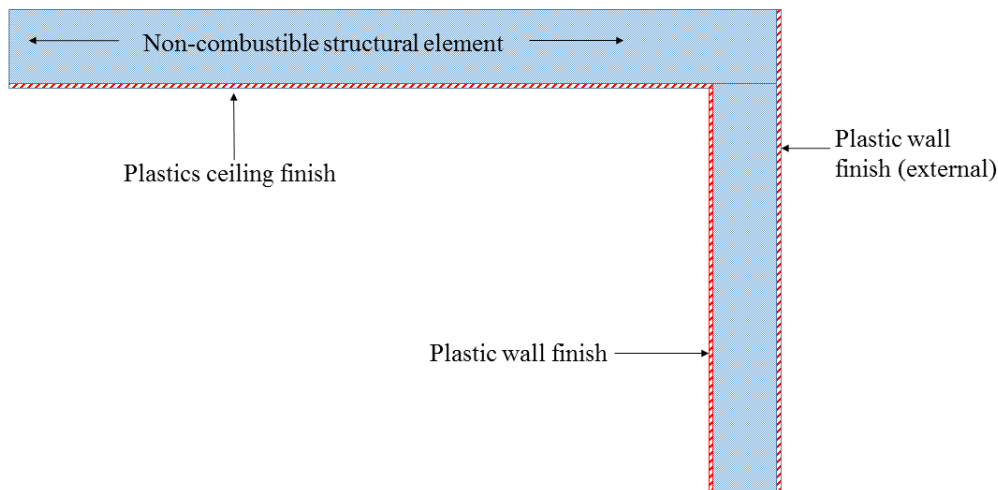

Diagram 3.15.19c.(4) : Plastic wall or ceiling material/finishes
installed internally/externally

TABLE 3.15G : PLASTIC WALL OR CEILING MATERIAL/FINISHES			
S/N	Material Construction	Assessment	Remarks
1	Non-combustible material	Allowed	No further fire test required.
2	Material thickness not exceeding 1mm	Allowed	No further fire test required.
3	Use in exit staircase/ exit passageways	Not allowed	Key escape routes shall be protected.
4	Material thickness exceeding 1mm	Allowed with conditions	Allowed if pass test categories D, E and F in <i>Table 3.15B</i> , unless specifically exempted for external building applications.

CONDITIONS FOR THE USE OF COMPOSITE PANEL WITH PLASTIC USED AS WALL FINISHES OR CEILING FINISHES

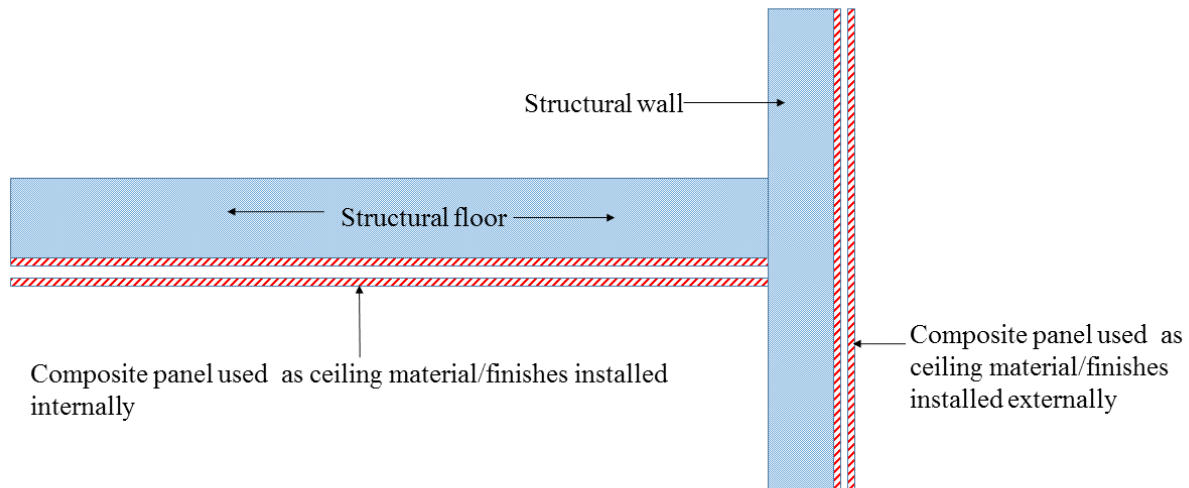
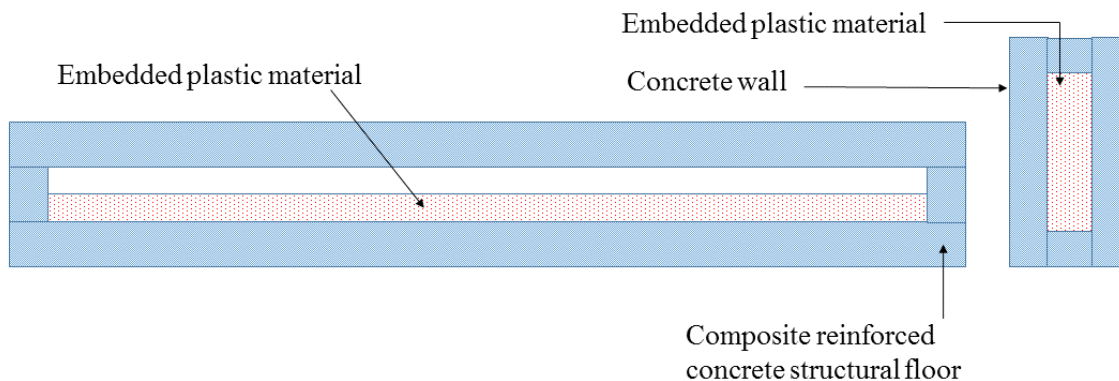

Diagram 3.15.19c.(5) : Composite panel with plastic used as wall or ceiling material/finishes installed internally/externally

TABLE 3.15H : COMPOSITE PANEL WITH PLASTIC USED AS WALL OR CEILING MATERIAL/FINISHES			
S/N	Material Construction	Assessment	Remarks
1	Non-combustible plastic material	Allowed	No further fire test required.
2	Plastic material thickness not exceeding 1mm	Allowed	No further fire test required.
3	Use in exit staircase/ exit passageways	Not allowed	Key escape routes shall be protected.
4	Plastic material thickness exceeding 1mm	Allowed with conditions	Allowed if pass test categories D, E and F in <i>Table 3.15B</i> , unless specifically exempted for external building applications.

CONDITIONS FOR THE USE OF PLASTIC MATERIAL EMBEDDED IN MASONRY WALL/CEILING



[Diagram 3.15.19c.\(6\) : Plastic material embedded within wall/ceiling](#)

TABLE 3.15I : PLASTIC MATERIAL EMBEDDED IN MASONRY WALL/CEILING			
S/N	Material Construction	Assessment	Remarks
1	Non-combustible material	Allowed	No further fire test required.
2	Material thickness not exceeding 1mm	Allowed	No further fire test required.
3	Use in exit staircase/ exit passageways	Not allowed	Key escape routes shall be protected.
4	Material thickness exceeding 1mm	Allowed with conditions	<ol style="list-style-type: none"> 1. If masonry cover is less than 25mm thick, the material shall pass test categories D, E and F in <u>Table 3.15B</u>. 2. If masonry cover is at least 25mm thick all around the embedded plastic, tests in <u>Table 3.15B</u> are exempted. 3. The locations where embedded plastics are installed shall be clearly indicated on the plans.

CONDITIONS FOR THE USE OF PLASTIC ROOF COVERING

TABLE 3.15J : PLASTIC ROOF COVERING			
S/N	Material Construction	Assessment	Remarks
1	Non-combustible material	Allowed	No further fire test required.
2	Material thickness not exceeding 1mm	Allowed	No further fire test required.
3	Use in exit staircase/ exit passageways	Not allowed	Key escape routes shall be protected.
4	Material thickness exceeding 1mm	Allowed with conditions	<ol style="list-style-type: none"> 1. Allowed if pass test category J in <u>Table 3.15C</u>, as well as test category H in <u>Table 3.15C</u> if exposed on underside. 2. Exempted from test categories H and if the requirements specified for skylights in <u>Cl.3.13.5b</u>.

CONDITIONS FOR THE USE OF COMPOSITE PANEL CONTAINING PLASTIC AS ROOF COVERING

TABLE 3.15K : COMPOSITE PANEL WITH PLASTIC USED AS ROOF COVERING			
S/N	Material Construction	Assessment	Remarks
1	Non-combustible plastic material	Allowed	No further fire test required.
2	Plastic material thickness not exceeding 1mm	Allowed	No further fire test required.
3	Use in exit staircase/ exit passageways	Not allowed	Key escape routes shall be protected.
4	Plastic material thickness exceeding 1mm	Allowed with conditions	<ol style="list-style-type: none"> 1. Allowed if pass test category J in <u>Table 3.15C</u>, as well as test category H in <u>Table 3.15C</u> if exposed on underside. 2. Exempted from test categories H and J if the requirements specified for skylights in <u>Cl.3.13.5b</u>.

ANNEX 3A
NOTIONAL PERIODS OF FIRE RESISTANCE

A1.0 GENERAL

In this Annex:

- a. “Class 1 aggregate” means foamed slag, pumice, blast furnace slag, pelleted fly ash, crushed brick and burnt clay products (including expanded clay) well-burnt clinker and crushed limestone.
- b. “Class 2 aggregate” means flint gravel, granite, and all crushed natural stones other than limestones.
- c. Any reference to plaster means:
 - (1) in the case of an external wall 1m or more from the relevant boundary, plaster applied on the internal face only;
 - (2) in the case of any other wall, plaster applied on both faces;
 - (3) if to plaster of a given thickness on the external face of a wall, except in the case of a reference to vermiculite-gypsum plaster, rendering on the external face of the same thickness; and
 - (4) if to vermiculite-gypsum plaster, vermiculite-gypsum plaster of a mix within the range of 1½ to 2:1 by volume.
- d. In the case of a cavity wall, the load is assumed to be on inner leaf only except for fire resistance period of 4-hrs.
- e. Any material or type of construction and its method of preparation or application as referred to in the table, shall conform with the relevant provisions of the Building Control Act (Chapter 29) and the relevant Singapore Standard or Singapore Standard Code of Practice. In the absence of the aforementioned Standard or Code of Practice, the relevant British equivalent or other accepted standard or codes of practice shall be applicable.

A2.0 : WALLS

Construction and materials	Minimum thickness excluding plaster (in mm) for period of fire resistance of											
	Load-bearing						Non-load-bearing					
	4 hrs	3 hrs	2 hrs	1½ hrs	1 hr	½ hr	4 hrs	3 hrs	2 hrs	1½ hrs	1 hr	½ hr
A2.1 - Masonry Construction												
1. Reinforced concrete, minimum concrete cover to main reinforcement of 25mm:												
(a) Unplastered (to comply with SS EN 1992-1-2)	180	-	100	100	75	75	-	-	-	-	-	-
(b) 12.5mm cement-sand plaster	180	-	100	100	75	75	-	-	-	-	-	-
(c) 12.5mm gypsum-sand plaster	180	-	100	100	75	75	-	-	-	-	-	-
(d) 12.5mm vermiculite-gypsum plaster	125	-	75	75	63	63	-	-	-	-	-	-
2. No-fines concrete of Class 2 aggregate:												
(a) 13mm cement-sand plaster	-	-	-	-	-	-	150	150	150	150	150	150
(b) 13mm gypsum-sand plaster	-	-	-	-	-	-	150	150	150	150	150	150
(c) 13mm vermiculite-gypsum plaster	-	-	-	-	-	-	150	150	150	150	150	150
3. Bricks of clay, concrete or sand-lime:												
(a) Unplastered	200	200	100	100	100	100	170	170	100	100	75	75
(b) 13mm cement-sand plaster	200	200	100	100	100	100	170	170	100	100	75	75
(c) 13mm gypsum-sand plaster	200	200	100	100	100	100	170	170	100	100	75	75
(d) 13mm vermiculite-gypsum or perlite-gypsum* plaster	100	-	100	100	100	100	100	-	100	100	75	75

A2.0 : WALLS

Construction and materials	Minimum thickness excluding plaster (in mm) for period of fire resistance of												
	Load-bearing						Non-load-bearing						
	4 hrs	3 hrs	2 hrs	1½ hrs	1 hr	½ hr	4 hrs	3 hrs	2 hrs	1½ hrs	1 hr	½ hr	
A2.1 - Masonry Construction (cont'd)													
4. Concrete blocks of Class 1 aggregate:													
(a) Unplastered	150	-	100	100	100	100	150	-	75	75	75	50	
(b) 12.5mm cement-sand plaster	150	-	100	100	100	100	100	-	75	75	75	50	
(c) 12.5mm gypsum-sand plaster	150	-	100	100	100	100	100	-	75	75	75	50	
(d) 12.5mm vermiculite-gypsum plaster	100	-	100	100	100	100	75	-	75	62	50	50	
5. Concrete blocks of Class 2 aggregate:													
(a) Unplastered	-	-	100	100	100	100	150	-	100	100	75	50	
(b) 12.5mm cement-sand plaster	-	-	100	100	100	100	150	-	100	100	75	50	
(c) 12.5mm gypsum-sand plaster	-	-	100	100	100	100	150	-	100	100	75	50	
(d) 12.5mm vermiculite-gypsum plaster	100	-	100	100	100	100	100	-	75	75	75	50	
6. Autoclaved aerated concrete blocks, density 475 - 1200 kg/m³													
(a) Unplastered	180	140	100	100	100	100	100	-	62	62	50	50	
7. Hollow concrete blocks, one cell in wall thickness, of Class 1 aggregate:													
(a) Unplastered	-	-	100	100	100	100	150	-	100	100	100	75	
(b) 12.5mm cement-sand plaster	-	-	100	100	100	100	150	-	100	75	75	75	
(c) 12.5mm gypsum-sand plaster	-	-	100	100	100	100	150	-	100	75	75	75	
(d) 12.5mm vermiculite-gypsum plaster	-	-	100	100	100	100	100	-	75	75	62	62	

A2.0 : WALLS

Construction and materials	Minimum thickness excluding plaster (in mm) for period of fire resistance of												
	Load-bearing						Non-load-bearing						
	4 hrs	3 hrs	2 hrs	1½ hrs	1 hr	½ hr	4 hrs	3 hrs	2 hrs	1½ hrs	1 hr	½ hr	
A2.1 - Masonry Construction (cont'd)													
8. Hollow concrete blocks, one cell in wall thickness, of Class 2 aggregate:													
(a) unplastered	-	-	-	-	-	-	150	-	150	-	-	-	125
(b) 12.5mm cement-sand plaster	-	-	-	-	-	-	150	-	150	-	-	-	125
(c) 12.5mm gypsum-sand plaster	-	-	-	-	-	-	150	-	150	-	-	-	125
(d) 12.5mm vermiculite-gypsum plaster	-	-	-	-	-	-	125	-	100	-	-	-	100
9. Cellular clay blocks not less than 50% solid:													
(a) 12.5mm cement-sand plaster	-	-	-	-	-	-	-	-	-	-	-	-	75
(b) 12.5mm gypsum-sand plaster	-	-	-	-	-	-	-	-	-	-	-	-	75
(c) 12.5mm vermiculite-gypsum plaster	-	-	-	-	-	-	200	-	100	-	-	-	62
10. Cavity wall with outer leaf of bricks or blocks of clay, composition, concrete or sand-lime, not less than 100mm thick and;													
(a) inner leaf of bricks or blocks of clay, composition, concrete or sand lime	100	100	100	100	100	100	75	-	75	-	-	-	75
(b) inner leaf of solid or hollow concrete bricks or blocks of Class 1 aggregate	100	100	100	100	100	100	75	-	75	-	-	-	75

A2.0 : WALLS

Construction and materials	Minimum thickness excluding plaster (in mm) for period of fire resistance of											
	Load-bearing					Non-load-bearing						
	4 hrs	3 hrs	2 hrs	1½ hrs	1 hr	½ hr	4 hrs	3 hrs	2 hrs	1½ hrs	1 hr	½ hr
A2.1 - Masonry Construction (cont'd)												
11. Cavity wall with outer leaf of cellular clay blocks as 9 above and inner leaf of autoclaved aerated concrete blocks, density 480-1200 kg/m ³	150	140	100	100	100	100	75	75	75	75	75	75
* = Perlite-gypsum plaster to clay bricks only												

<u>A2.0 : WALLS</u>	
Construction and Materials	Period of Fire Resistance
A2.2 - Framed and Composite Construction (non-load-bearing)	
1. Steel frame with external cladding of 16mm rendering on metal lathing and internal lining of autoclaved aerated concrete blocks, density 480-1120 kg/m ³ of thickness of – (a) 50mm (b) 62mm (c) 75mm	2 hrs 3 hrs 4 hrs
2. Steel frame with external cladding of 100mm concrete blocks and internal lining of 16mm gypsum plaster on metal lathing	4 hrs
3. Steel frame with external cladding of 16mm rendering on metal lathing and internal lining of 16mm gypsum plaster on metal lathing	1 hr
4. Steel or timber frame with facings on each side of - (a) metal lathing with cement-sand or gypsum plaster of thickness of- (1) 19mm (2) 12.5mm (b) metal lathing with vermiculite-gypsum or perlite-gypsum plaster of thickness of- (1) 25mm (2) 19mm (3) 12.5mm (c) 9.5mm plasterboard with gypsum plaster of thickness of 5mm (d) 9.5mm plasterboard with vermiculite-gypsum of thickness of- (1) 25mm (2) 16mm (3) 10mm (4) 5mm (e) 12.5mm plasterboard- (1) unplastered (2) with gypsum plaster of thickness of 12.5mm (f) 12.5mm plasterboard with vermiculite-gypsum plaster of thickness of- (1) 25mm (2) 16mm (3) 10mm (g) 19mm plasterboard (or two layers of 9.5mm fixed to break joint) without finish	1 hr ½ hr 2 hrs 1½ hrs 1 hr ½ hr 2 hrs 1½ hrs 1 hr ½ hr ½ hr 1 hr 2 hrs 1½ hrs 1 hr 1 hr 1 hr

ANNEX 3A

<u>A2.0 : WALLS</u>	
Construction and Materials	Period of Fire Resistance
A2.2 - Framed and Composite Construction (non-load-bearing) (cont'd)	
(h) 19mm plasterboard for two layers of 9.5mm with vermiculite-gypsum plaster of thickness of- (1) 16mm (2) 10mm	2 1½
(i) 12.5mm fibre insulating board with gypsum plaster of thickness of 12.5mm	½
(j) 25mm wood wool slabs with gypsum plaster of thickness of 12.5mm	1
5. Compressed straw slabs in timber frames finished on both faces with gypsum plaster of thickness of 5mm	1
6. Plasterboard 9.5mm cellular core partition- (a) unplastered (b) 12.5mm gypsum plaster (c) 22mm vermiculite-gypsum plaster	½ ½ 2
7. Plasterboard 12.5mm cellular core partition- (a) unplastered (b) 12.5mm gypsum plaster (c) 16mm vermiculite-gypsum plaster	½ 1 2
8. Plasterboard 19mm finished on both faces with 16mm gypsum plaster	1
9. Plasterboard 12.5mm bonded with neat gypsum plaster to each side of 19mm plasterboard	1½
10. Three layers of 19mm plasterboard bonded with neat gypsum plaster	2
11. Wood wool slab with 12.5mm rendering or plaster of thickness of- (a) 75mm (b) 50mm	2 1
12. Compressed straw slabs, with 75mm by 12.5mm wood cover strips to joints, of thickness of 50mm	½
<u>Note :</u> * = The presence of a combustible vapour barrier within the thickness of these constructions shall not be regarded as affecting these periods of fire resistance	

<u>A2.0 : WALLS</u>	
Construction and Materials	Period of Fire Resistance
A2.3 - External walls (non-loadbearing) more than 1m from the relevant boundary	
1. Steel frame with external cladding of non-combustible sheets and internal lining of- <ul style="list-style-type: none"> (a) 12.5mm cement-sand or gypsum plaster on metal lathing (b) two layers of 9.5mm plasterboard (c) 9.5mm plasterboard finished with gypsum plaster of thickness of 12.5mm (d) 12.5mm plasterboard finished with 5mm gypsum plaster (e) 50mm compressed straw slabs (f) 50mm compressed straw slabs finished with 5mm gypsum plaster 	4 $\frac{1}{2}$ $\frac{1}{2}$ $\frac{1}{2}$ $\frac{1}{2}$ 2
2. *Timber frame with external cladding of 10mm cement-sand or cement-lime rendering and internal lining of- <ul style="list-style-type: none"> (a) 16mm gypsum plaster on metal lathing (b) 9.5mm plasterboard finished with 12.5 mm gypsum plaster (c) 12.5mm plasterboard finished with 5mm gypsum plaster (d) 50mm compressed straw slabs (e) aerated concrete blocks <ul style="list-style-type: none"> (1) 50mm (2) 62mm (3) 75mm (4) 100mm 	1 1 1 1 3 4 4 4
3. Timber frame with external cladding of 100mm clay, concrete or sand-lime bricks or blocks, finished internally with 16mm gypsum plaster on metal lathing	4
4. *Timber frame with external cladding of weather boarding or 9.5 mm plywood and internal lining of- <ul style="list-style-type: none"> (a) 16mm gypsum plaster on metal lathing (b) 9.5mm plasterboard finished with 12.5mm gypsum plaster (c) 12.5mm plasterboard finished with 5mm gypsum plaster (d) 50mm compressed straw slabs (e) aerated concrete blocks- <ul style="list-style-type: none"> (1) 50mm (2) 62mm (3) 75mm (4) 100mm 	$\frac{1}{2}$ $\frac{1}{2}$ $\frac{1}{2}$ $\frac{1}{2}$ 3 4 4 4
Note : * = The presence of a combustible vapour barrier within the thickness of these constructions shall not be regarded as affecting these periods of fire resistance	

ANNEX 3A

A3.0 : REINFORCED CONCRETE BEAMS

Description	Minimum Dimension (in mm) of Concrete to give a Fire Resistance of:-					
	4 hrs	3 hrs	2 hrs	1½ hrs	1 hr	½ hr
1. Siliceous aggregate concrete:						
(a) average concrete cover to main reinforcement	65*	55*	45*	35	25	15
(b) beam width	280	240	180	140	110	80
2. As (1) with cement or gypsum plaster 15mm thick on light mesh reinforcement						
(a) average concrete cover to main reinforcement	50*	40	30	20	15	15
(b) beam width	250	210	170	110	85	70
3. As (1) with vermiculite/gypsum plaster ⁺ 15mm thick:						
(a) average concrete cover to main reinforcement	25	15	15	15	15	15
(b) beam width	170	145	125	85	60	60
4. Light weight aggregate concrete:						
(a) average concrete cover to main reinforcement	50	45	35	30	20	15
(b) beam width	250	200	160	130	100	80
Note :						
* = Supplementary reinforcement, to hold the concrete cover in position, may be necessary.						
+ = Vermiculite/gypsum plaster should have a mix ratio in the range of 1½ - 2 : 1 by volume.						

A4.0 : PRESTRESSED CONCRETE BEAMS

Description	Minimum Dimension (in mm) of Concrete to give a Fire Resistance of :					
	4 hrs	3 hrs	2 hrs	1½ hrs	1 hr	½ hr
1. Siliceous aggregate concrete						
(a) average concrete cover to tendons	100*	85*	65*	50*	40	25
(b) beam width	280	240	180	140	110	80
2. As (1) with vermiculite concrete slabs 15mm thick , used as permanent shuttering :						
(a) average concrete cover to tendons	75*	60	45	35	25	15
(b) beam width	210	170	125	100	70	70
3. As (2) but with 25mm thick slabs:						
(a) average concrete cover to tendons	65	50	35	25	15	15
(b) beam width	180	140	100	70	60	60
4. As (1) with 15mm thick gypsum plaster with light mesh reinforcement:						
(a) average concrete cover to tendons	90*	75	50	40	30	15
(b) beam width	250	210	170	110	85	70
5. As (1) with vermiculite/gypsum plaster ⁺ 15m thick:						
(a) average concrete cover to tendons	75*	60	45	30	25	15
(b) beam width	170	145	125	85	60	60
6. As (5) but with 25mm thick coating:						
(a) average concrete cover to tendons	50	45	30	25	15	15
(b) beam width	140	125	85	70	60	60
7. Lightweight aggregate concrete:						
(a) average concrete cover to tendons	80	65	50	40	30	20
(b) beam width	250	200	160	130	100	80
Note :						
* = Supplementary reinforcement, to hold the concrete cover in position, may be necessary.						
+ = Vermiculite/gypsum plaster should have a mix ratio in the range of 1½ - 2 : 1 by volume.						

ANNEX 3A

A5.0 : REINFORCED CONCRETE COLUMNS

Description	Minimum Dimension (in mm) of Concrete to give a Fire Resistance of :					
	4 hrs	3 hrs	2 hrs	1½ hrs	1 hr	½ hr
A5.1 - All Face Exposed						
1. Siliceous aggregate concrete						
(a) without additional protection	450	400	300	250	200	150
(b) with cement or gypsum plaster 15mm thick on light mesh reinforcement	300	275	225	150	150	150
(c) with vermiculite / gypsum plaster*	275	225	200	150	120	120
2. Limestone aggregate concrete or siliceous aggregate:						
(a) concrete with supplementary reinforcement in concrete cover	300	275	225	200	190	150
3. Lightweight aggregate concrete	300	275	225	200	150	150
A5.2 - One Face Exposed						
1. Siliceous aggregate concrete						
(a) without additional protection	180	150	100	100	75	75
(b) with vermiculite/ gypsum plaster* 15mm thick on exposed faces	125	100	75	75	65	65
Note :						
* = Vermiculite/gypsum plaster should have a mix ratio in the range of 1 ½ - 2 : 1 by volume.						

<u>A6.0 : STRUCTURAL STEEL</u>						
A6.1 - Encased Steel Stanchions (Mass per metre not less than 45kg)						
Description	Minimum Thickness (in mm) of Protection for a Fire Resistance of :					
	4 hrs	3 hrs	2 hrs	1½ hrs	1 hr	½ hr
A. Solid Protection* (unplastered)						
1. Concrete not leaner than 1:2:4 mix with natural aggregates-						
(a) concrete not assumed to be load-bearing reinforced+	50	-	25	25	25	25
(b) concrete assumed to be load-bearing, reinforced in accordance with SS EN 1992 and SS EN 1994	75	-	50	50	50	50
2. Solid bricks of clay, composition or sand-lime	100	75	50	50	50	50
3. Solid blocks of foamed slag or pumice concrete reinforced+ in every horizontal joint	75	60	50	50	50	50
4. Sprayed vermiculite-cement	-	-	38	32	19	12.5
B. Hollow Protection**						
1. Solid bricks of clay, composition or sand-lime reinforced in every horizontal joint, unplastered	115	-	50	50	50	50
2. Solid blocks of foamed slag or pumice concrete reinforced+ in every horizontal joint, unplastered	75	-	50	50	50	50
3. Metal lathing with gypsum or cement-lime plaster of thickness of -	-	-	38§	25	19	12.5
4. Metal lathing :-						
(a) with vermiculite-gypsum or perlite-gypsum plaster of thickness of	50§	-	19	16	12.5	12.5
(b) spaced 25mm from flanges with vermiculite-gypsum or perlite-gypsum plaster of thickness of	44	-	19	12.5	12.5	12.5
5. Gypsum plasterboard with 1.6mm wire binding at 100mm pitch -						
(a) 9.5mm Plasterboard with gypsum-plaster of thickness of	-	-	-	-	12.5	12.5
(b) 19mm Plasterboard with gypsum plaster of thickness of	-	-	12.5	10	7	7

ANNEX 3A

A6.0 : STRUCTURAL STEEL**A6.1 - Encased Steel Stanchions (Mass per metre not less than 45kg)**

Description	Minimum Thickness (in mm) of Protection for a Fire Resistance of :					
	4 hrs	3 hrs	2 hrs	1½ hrs	1 hr	½ hr
6. Gypsum plasterboard with 1.6mm wire binding at 100mm pitch-						
(a) 9.5mm plasterboard with vermiculite-gypsum plaster of thickness of	-	-	16	15	10	10
(b) 19mm plasterboard with vermiculite-gypsum plaster of thickness of	38§	-	20	13	10	10
7. Vermiculite-cement slabs of 4:1 mix reinforced with wire mesh and finished with plaster skim. Slabs of thickness of	63	-	25	25	25	25

Note :

- * = Solid protection means a casing which is bedded close to the steel without intervening cavities and with all joints in that casing made full and solid.
- + = Reinforcement shall consist of steel binding wire not less than 2.3mm in thickness, or a steel mesh weighing not less than 0.48 kg/m². In concrete protection, the spacing of that reinforcement shall not exceed 150mm in any direction
- ++ = Hollow protection means that there is a void between the protective material and the steel. All hollow protection to columns shall be effectively sealed at each floor level.
- § = Light mesh reinforcement required 12.5mm to 19mm below surface unless special corner beads are used.

A6.2 - Encased Steel Beams (Mass per metre not less than 30kg)

Description	Minimum Thickness (in mm) of Protection for a Fire Resistance of :					
	4 hrs	3 hrs	2 hrs	1½ hrs	1 hr	½ hr
A. Solid Protection⁺ (unplastered)						
1. Concrete not leaner than 1:2:4 mix with natural aggregate -						
(a) concrete not assumed to be load-bearing , reinforced++	75	50	25	25	25	25
(b) concrete assumed to be load-bearing, reinforced in accordance with SS EN 1992 and SS EN 1994	75	75	50	50	50	50
2. Sprayed vermiculite - cement	-	-	38	32	19	12.5

A6.2 - Encased Steel Beams (Mass per metre not less than 30kg)						
Description	Minimum Thickness (in mm) of Protection for a Fire Resistance of :					
	4 hrs	3 hrs	2 hrs	1½ hrs	1 hr	½ hr
B. Hollow Protection*						
1. Metal lathing -						
(a) with cement-lime plaster of thickness of	-	-	38	25	19	12.5
(b) with gypsum plaster of thickness of	-	-	22	19	16	12.5
(c) with vermiculite-gypsum or perlite-gypsum plaster of thickness of	32	-	12.5	12.5	12.5	12.5
2. Gypsum plasterboard with 1.6mm wire binding at 100mm pitch-						
(a) 9.5mm plasterboard with gypsum plaster of thickness of	-	-	-	-	12.5	12.5
(b) 19 mm plasterboard with gypsum plaster of thickness of	-	-	12.5	10	7	7
3. Plasterboard with 1.6mm wire at 100m pitch -						
(a) 9.5mm plaster nailed to wooden cradles finished with gypsum plaster of thickness of	-	-	-	-	-	12.5
(b) 9.5mm plasterboard with vermiculite -gypsum plaster of thickness of	-	-	16	15	10	10
(c) 19mm plasterboard with vermiculite-gypsum plaster of thickness of	32	-	10	10	7	7
(d) 19mm plasterboard with gypsum plaster of thickness of	-	-	20	13	10	10
4. Vermiculite-cement slabs of 4:1 mix reinforced with wire mesh and finished with plaster skim. Slabs of thickness of	63	-	25	25	25	25
5. Gypsum-sand plaster 12.5mm thick applied to heavy duty (Type B as designated in EN 13168) Wood wool slabs of thickness of	-	-	50	38	38	38
Note :						
* = Hollow protection means that there is a void between the protective materials and the steel. All hollow protection to columns shall be effectively sealed at each floor level.						
+ = Solid protection means a casing which is bedded close to the steel without intervening cavities and with all joints in that casing made full and solid.						
++ = Reinforcement shall consist of steel binding wire not less than 2.3mm in thickness, or a steel mesh weighing not less than 0.48 kg/m ² . In concrete protection, the spacing of that reinforcement shall not exceed 150mm in any direction.						
§ = Light mesh reinforcement required 12.5mm to 19mm below surface unless special corner beads are used.						

ANNEX 3A

<u>A7.0 : STRUCTURAL ALUMINIUM</u>						
Description	Minimum Thickness (in mm) of Protection for a Fire Resistance of :					
	4 hrs	3 hrs	2 hrs	1½ hrs	1 hr	½ hr
A7.1 - Solid Protection*						
1. Sprayed vermiculite-cement	-	-	-	-	44	19
A7.2 - Hollow Protection⁺						
1. Metal lathing with vermiculite-gypsum or perlite-gypsum plaster of thickness of	-	-	32	22	16	12.5
2. Metal lathing finished with neat gypsum plaster of thickness of	-	-	-	-	19	12.5
3. Gypsum plasterboard 19mm thick with 1.6 mm wire binding at 100mm pitch finished with gypsum-vermiculite plaster of thickness of	-	-	22	16	10	10
<p><u>Note :</u></p> <p>* = Solid protection means a casing which is bedded close to the alloy without intervening cavities and with all joints in that casing made full and solid.</p> <p>+ = Hollow protection means that there is a void between the protected material and the alloy. All hollow protection to columns shall be effectively sealed at each floor level</p>						

<u>A8.0 : TIMBER FLOORS</u>			
Construction and materials	Minimum Thickness (in mm) of Protection for a Fire Resistance of :		
	1 hr	½ hr	modified** ½ hr
1. Plain edge boarding on timber joists not less than 38mm wide with ceiling of -			
(a) timber lath and plaster - thickness of plaster	-	16	16
(b) timber lath and plaster with plaster of minimum thickness of 16mm covered on underside with plasterboard of thickness	-	12.5	-
(c) metal lathing and plaster - thickness of plaster			
(1) gypsum	-	16	-
(2) vermiculite	-	12.5	-
(d) one layer of plasterboard of thickness	-	-	12.5
(e) one layer of plasterboard of minimum thickness of 9.5mm finished with gypsum plaster of thickness	-	-	12.5
(f) one layer of plasterboards of minimum thickness of 12.5mm finished with gypsum plaster of thickness	-	12.5	-
(g) two layers of plasterboard of total thickness	-	25	19
(h) one layer of fibre insulating board of minimum thickness of 9.5mm finished with gypsum plaster of thickness	-	5	-
(i) one layer of fibre insulating board of minimum thickness of 12.5mm finished with gypsum plaster of thickness	-	-	12.5
(j) wood wool slab 25mm thick finished with gypsum plaster of thickness	-	5	-
2. Tongued and grooved boarding of not less than 16mm (finished) thickness* on timber joists not less than 38 mm wide ceiling of -			
(a) timber lath and plaster - thickness of plaster	-	-	16
(b) timber lath and plaster with plaster of minimum thickness of 16mm covered on underside with plasterboard of thickness	-	9.5	-
(c) metal lathing and plaster - thickness of plaster			
(1) gypsum	22	16	-
(2) vermiculite	12.5	12.5	-
(d) one layer of plasterboard of thickness	-	-	9.5
(e) one layer of plasterboard of minimum thickness of 9.5mm finished with-			
(1) gypsum plaster of thickness	-	12.5	-
(2) vermiculite-gypsum plaster of thickness	12.5	-	-

ANNEX 3A

A8.0 : TIMBER FLOORS

Construction and materials	Minimum Thickness (in mm) of Protection for a Fire Resistance of :		
	1 hr	½ hr	modified ⁺⁺ ½ hr
(f) one layer of plasterboards of minimum thickness of 12.5mm finished with gypsum plaster of thickness	-	5	-
(g) two layers of plasterboard of total thickness	-	22	-
(h) one layer of fibre insulating board of minimum thickness of 9.5mm finished with gypsum plaster of thickness	-	-	5
(i) wood wool slab 25mm thick finished with -			
(1) gypsum plaster of thickness	-	5	-
(2) vermiculite - gypsum plaster of thickness	10	-	-
3. Tongued and grooved boardings of not less than 21mm (finished) thickness* on timber joists not less than 175mm deep by 50mm wide and ceiling of -			
(a) timber lath and plaster - thickness of plaster	-	16	-
(b) metal lathing and plaster - thickness of plaster	-	16	-
(c) one layer of plasterboard of thickness	-	-	9.5
(d) one layer of plasterboard of minimum thickness of 9.5mm finished with -			
(1) gypsum plaster of thickness	-	12.5	-
(2) vermiculite - gypsum plaster of thickness	12.5	-	-
(e) one layer of plasterboard of minimum thickness of 12.5mm finished with gypsum plaster of thickness	-	5	-
(f) two layers of plasterboard of total thickness	-	19	-
(g) one layer of fibre insulating board of thickness	-	-	12.5
(h) one layer of fibre insulating board of minimum thickness of 12.5mm finished with gypsum plaster of thickness	-	12.5	-
(i) wood wool slab 25mm thick finished with -			
(1) gypsum plaster of thickness	-	5	-
(2) vermiculite-gypsum plaster of thickness	10	-	-

Note :

* = Or an equivalent thickness of wood chipboard

++ = The term "modified ½ hour" refers to the requirements specified in item 3(a) of Table 3.4A

A9.0 : REINFORCED CONCRETE FLOORS (SILICEOUS OR CALCAREOUS AGGREGATE)

Floor Construction		Minimum Dimension (in mm) to give Fire Resistance of :					
		4 hrs	3 hrs	2 hrs	1½ hrs	1 hr	½ hr
Solid slab	Average cover to reinforcement	25	25	20	20	15	15
		150	150	125	125	100	100
Cored slabs in which the cores are circular or are higher than wide. Not less than 50% of the gross across section of the floor should be solid material	Average cover to reinforcement	25	25	20	20	15	15
	Thickness under cores	50	40	40	30	25	20
Hollow box section with one or more longitudinal cavities which are wider than high	Depth, overall*	190	175	160	140	110	100
	Average cover to reinforcement	25	25	20	20	15	15
Ribbed floor with hollow infill blocks of clay, or inverted T-section beams with hollow infill blocks of concrete or clay. A floor in which less than 50% of the gross cross section is solid material must be provided with a 15mm plaster coating on soffit	Thickness of bottom flange	50	40	40	30	25	20
	Depth, overall*	230	205	180	155	130	105
Upright T-section	Average cover to reinforcement	25	25	20	20	15	15
	Width or rib, or beam, at soffit	125	100	90	80	70	50
Inverted channel sections with radius at intersection of soffits with top of leg not exceeding depth of section	Depth, overall*	190	175	160	140	110	100
	Average bottom cover to reinforcement	65*	55*	45*	35	25	15
Inverted channel sections with radius at intersection of soffits with top of leg not exceeding depth of section	Side cover to reinforcement	65	55	45	35	25	15
	Least width or down-standing leg	150	140	115	90	75	60
Inverted channel sections or U-sections with radius at intersection of soffits with top of leg exceeding depth of section	Thickness of flange*	150	150	125	125	100	90
	Average bottom cover to reinforcement	65*	55*	45*	35	25	15
Inverted channel sections or U-sections with radius at intersection of soffits with top of leg exceeding depth of section	Side cover to reinforcement	40	30	25	20	15	10
	Least width or down-standing leg	75	70	60	45	40	30
Inverted channel sections or U-sections with radius at intersection of soffits with top of leg exceeding depth of section	Thickness at crown*	150	150	125	125	100	90
	Average bottom cover to reinforcement	65*	55*	45*	35	25	15
Inverted channel sections or U-sections with radius at intersection of soffits with top of leg exceeding depth of section	Side cover to reinforcement	40	30	25	20	15	10
	Least width or down-standing leg	70	60	50	40	35	25
Inverted channel sections or U-sections with radius at intersection of soffits with top of leg exceeding depth of section	Thickness at crown*	150	150	100	100	75	65

* = Supplementary reinforcement, to hold the concrete cover in position, may be necessary.

+ = Non-combustible screeds and finishes may be included in these dimensions.

A10.0 : PRESTRESSED CONCRETE FLOORS (SILICEOUS OR CALCAREOUS AGGREGATE)

Floor Construction	Minimum Dimension (in mm) to give Fire Resistance of :					
	4 hrs	3 hrs	2 hrs	1½ hrs	1 hr	½ hr
Solid slab	Average cover to tendons	50*	40	30	25	15
	Depth, overall ⁺	150	125	125	100	90
Cored slabs in which the cores are circular or are higher than wide. Not less than 50% of the gross cross section of the floor should be solid material	Average cover to tendons	50*	40	30	25	15
	Thickness under cores	50	40	30	25	20
Hollow box section with one or more longitudinal cavities which are wider than high	Depth, overall ⁺	190	160	140	110	100
	Average cover to tendons	65*	40	30	25	15
Ribbed floor with hollow infill blocks of clay, or inverted T-section beams with hollow infill blocks of concrete or clay. A floor in which less than 50% of the gross cross section is solid material must be provided with a 15mm plaster coating on soffit	Thickness of bottom flange	65	40	30	25	25
	Depth, overall ⁺	230	180	155	130	105
Upright T-section	Average cover to tendons	65*	40	30	25	15
	Width of rib, or beam, at soffit	125	100	90	80	70
Inverted channel sections with radius at intersection of soffits with top of leg not exceeding depth of section	Depth, overall ⁺	190	160	140	110	100
	Average bottom cover to tendons	100*	85*	65*	50*	40
Inverted channel sections with radius at intersection of soffits with top of leg not exceeding depth of section	Side cover to tendons	100	65	50	40	25
	Least width or down-standing leg	250	200	150	110	90
Inverted channel sections or U-sections with radius at intersection of soffits with top of leg exceeding depth of section	Thickness of flange ⁺	150	125	125	100	90
	Average bottom cover to tendons	100*	85*	65*	50*	40
Inverted channel sections or U-sections with radius at intersection of soffits with top of leg exceeding depth of section	Side cover to tendons	50	45	35	20	15
	Least width or down-standing leg	125	100	75	55	30
* = Supplementary reinforcement, to hold the concrete cover in position, may be necessary. + = Non-combustible screeds and finishes may be included in these dimensions.	Thickness at crown ⁺	150	125	125	100	90
	Average bottom cover to tendons	100*	85*	65*	50*	40
* = Supplementary reinforcement, to hold the concrete cover in position, may be necessary. + = Non-combustible screeds and finishes may be included in these dimensions.	Side cover to tendons	50	45	35	20	15
	Least width or down-standing leg	110	90	70	50	30
* = Supplementary reinforcement, to hold the concrete cover in position, may be necessary. + = Non-combustible screeds and finishes may be included in these dimensions.	Thickness at crown ⁺	150	125	125	100	90

<u>A11.0 : GLAZING</u>		
Construction and materials	Minimum Thickness (in mm) of Glazing for a Period of :-	
	1 hr	½ hr
<p>1. Glass, in direct combination with metal, the melting point of which is not lower than 982.2°C, in square not exceeding 0.015m² in area</p> <p>Thickness of glass</p>	-	6.35
<p>2. Glass reinforced with wire not less than 0.46mm in diameter laid to a square mesh measuring 12.70mm from centre to centre of wire, and electrically welded at the intersections, or laid to a hexagonal mesh measuring 25.40mm across the flat side</p> <p>Thickness of glass</p> <p>In windows, doors, borrowed lights, lanterns and skylights, glass complying with paragraphs 1 or 2 of this Table shall be fixed with wood or metal beads or with a glazing compound in conjunction with sprigs or clips in panels not exceeding 0.372m² in area in timber frames (fixed shut) having a minimum width and thickness of 44.45mm clear of rebates</p>	-	6.35
<p>3. Glass reinforced with wire as in paragraph 2 of this Table, in windows, doors, borrowed lights, lanterns and skylights, fixed with metal beads in panels not exceeding 1.115m² in metal frames (fixed shut) all metal having a melting point not lower than 982.2°C, the thickness of glass</p>	6.35	6.35
<p>4. Glass bricks or blocks in walls</p> <p>Laid in cement / lime / sand mortar with light wire reinforcing mesh in every third horizontal joint in a panel not exceeding 2.438m in width or height set along the sides and head into recesses in the surrounding non-combustible construction. The depth of such recessed shall be not less than 25.40mm, the glass blocks extending into the recesses to a depth of 12.70mm and bedded upon layer of glass fibre. A non-hardening mastic shall be used to fill the spaces between the sides of the recesses and the faces of the panels</p>	-	98.43
<p><u>Note :</u></p> <p>In this Table the absence of a figure in a period column indicated that glazing described is not acceptable for the period applicable to that column.</p>		

ANNEX 3B - LIMITS OF UNPROTECTED OPENINGS

B1.0 CALCULATION OF PERMITTED LIMITS OF UNPROTECTED AREAS

- B1.1 The permitted limit of unprotected areas in any side of a building or compartment shall be calculated by reference to the requirements of B2.0.
- B1.2 For the purposes of this Annex, the expression "unprotected area" has the meaning ascribed to it by *Cl.1.4.108*, but in calculating the size of unprotected areas or the permitted limit of unprotected areas, the following provisions shall apply -
- a. where any area of an external wall is an unprotected area, only because it has combustible material attached to it as cladding, the area of that unprotected area shall be deemed to be half the area of such cladding;
 - b. when unprotected openings in the same compartment are recessed at a distance or an angle to the plane of reference, the width of the unprotected opening can be reduced accordingly when projected to the plane of reference based on Table III and IV. However, such reduction is not applicable to the following:
 - (1) Concave building profile or the like where a specific point on the receiving panel receives radiation from more than one source.
 - (2) When the unprotected opening is along a continuous circular profile where its size and angle cannot be determined.
 - c. no account shall be taken of any of the following:
 - (1) an unprotected area which does not exceed 0.1m² and which is not less than 1.5m from any other unprotected area in the same side of the building or compartment (unless that other falls within (3) below);
 - (2) one or more unprotected areas having an area (or, if more than one, the aggregate area) not exceeding 1m² and not less than 4m from any other unprotected area in the same side of the building or compartment (except any such area as is specified in (1) above);
 - (3) an unprotected area in any part of an external wall which forms part of a protected shaft;
 - (4) an unprotected area in the side of a building not divided into compartments, if the area is not less than 28m above any ground adjoining that side of the building.

B2.0 RULES OF CALCULATION BY REFERENCE TO AN ENCLOSING RECTANGLE

- B2.1 The conditions of this Part of this Annex shall be satisfied if a building or compartment is so situated that no point on the relevant boundary is either between the relevant plane of reference and the side of the building or compartment or at a distance from the relevant plane of reference which is less than the distance specified in the Tables to this Part of this Annex, according to the purpose group of the building or compartment, the dimensions of the enclosing rectangle and the unprotected percentage.
- B2.2 For the purpose of this Part of this Annex:
- a. "relevant boundary" means as defined in *Cl.1.4.87* and for the purpose of this calculation is either parallel to the side of the building under consideration or at an angle of not more than 80° with that side;
 - b. "plane of reference" means any vertical plane which touches the side or some part of the side of a building or compartment but which (however far extended) does not pass within the structure of such building or compartment (and for this purpose, any balcony, coping or similar projection shall be deemed not to be part either of that side or of the structure); and the relevant plane of reference shall in each case be taken as that most favourable in that respect to the person erecting the building;
 - c. "enclosing rectangle" means the smallest rectangle on the relevant plane of reference which would:
 - (1) enclose all the outer edge of any unprotected area of the building or, if the building is divided into compartments, of the compartment (other than any of an unprotected area which is at an angle of more than 80° to the plane of reference the outer edges being for this purpose projected on the plane of reference by line perpendicular to such plane);
 - (2) have two horizontal sides; and
 - (3) have height and width falling within those listed in the Tables to this Part of this Annex.
 - d. "unprotected percentage" means the percentage of the area of the enclosing rectangle which is equal to the aggregate of the unprotected areas taken into account in calculating the enclosing rectangle and as projected on it.

TABLE 1 - BUILDINGS OR COMPARTMENTS OF PG I, PG II, PG III, PG IV, PG VII & PG VIII (for Open-sided Car Parking Decks only)

Enclosing Rectangle		Distance (in metres) from Relevant Boundary for Unprotected Percentage not exceeding									
Ht.	Width	20%	30%	40%	50%	60%	70%	80%	90%	100%	
3 metres	3m	1.0	1.0	1.0	1.5	1.5	1.5	2.0	2.0	2.0	
	6m	1.0	1.0	1.5	2.0	2.0	2.0	2.5	2.5	2.5	
	9m	1.0	1.0	1.5	2.0	2.5	2.5	3.0	3.0	3.0	
	12m	1.0	1.5	2.0	2.0	2.5	3.0	3.0	3.5	3.5	
	15m	1.0	1.5	2.0	2.5	2.5	3.0	3.5	3.5	4.0	
	18m	1.0	1.5	2.0	2.5	2.5	3.0	3.5	4.0	4.0	
	21m	1.0	1.5	2.0	2.5	3.0	3.0	3.5	4.0	4.5	
	24m	1.0	1.5	2.0	2.5	3.0	3.0	3.5	4.0	4.5	
	27m	1.0	1.5	2.0	2.5	3.0	3.5	3.5	4.0	4.5	
	30m	1.0	1.5	2.0	2.5	3.0	3.5	4.0	4.0	4.5	
	40m	1.0	1.5	2.0	2.5	3.0	3.5	4.0	4.0	5.0	
	No limit	1.0	1.5	2.0	2.5	3.0	3.5	4.0	4.0	4.0	
	6 metres	3m	1.0	1.0	1.5	2.0	2.0	2.0	2.5	2.5	3.0
		6m	1.0	1.5	2.0	2.5	3.0	3.0	3.5	4.0	4.0
9m		1.0	2.0	2.5	3.0	3.5	4.0	4.5	4.5	5.0	
12m		1.5	2.5	3.0	3.5	4.0	4.5	5.0	5.0	5.5	
15m		1.5	2.5	3.0	4.0	4.5	5.0	5.5	5.5	6.0	
18m		1.5	2.5	3.5	4.0	4.5	5.0	5.5	6.0	6.5	
21m		1.5	2.5	3.5	4.0	5.0	5.5	6.0	6.5	7.0	
24m		1.5	2.5	3.5	4.5	5.0	5.5	6.0	7.0	7.0	
27m		1.5	2.5	3.5	4.5	5.0	6.0	6.5	7.0	7.5	
30m		1.5	2.5	3.5	4.5	5.0	6.0	6.5	7.0	8.0	
40m		1.5	2.5	3.5	4.5	5.5	7.0	7.5	8.0	8.5	
50m		1.5	2.5	3.5	4.5	5.5	7.5	8.0	8.5	9.0	
60m		1.5	2.5	3.5	5.0	5.5	7.5	8.5	8.5	9.5	
80m		1.5	2.5	3.5	5.0	6.0	7.5	8.5	8.5	9.5	
100m	1.5	2.5	3.5	5.0	6.0	8.0	8.5	8.5	10.0		
No limit	1.5	2.5	3.5	5.0	6.0	8.0	8.5	8.5	10.0		

TABLE 1 - BUILDINGS OR COMPARTMENTS OF PG I, PG II, PG III, PG IV, PG VII & PG VIII (for Open-sided Car Parking Decks only) (cont'd)

Enclosing Rectangle		Distance (in metres) from Relevant Boundary for Unprotected Percentage not exceeding									
Ht.	Width	20%	30%	40%	50%	60%	70%	80%	90%	100%	
9 metres	3m	1.0	1.0	1.5	2.0	2.5	2.5	3.0	3.0	3.5	
	6m	1.0	2.0	2.5	3.0	3.5	4.0	4.5	4.5	5.0	
	9m	1.5	2.5	3.5	4.0	4.5	5.0	5.5	5.5	6.0	
	12m	1.5	3.0	3.5	4.5	5.0	5.5	6.0	6.5	7.0	
	15m	2.0	3.0	4.0	5.0	5.5	6.0	6.5	7.0	7.5	
	18m	2.0	3.5	4.5	5.0	6.0	6.5	7.0	8.0	8.5	
	21m	2.0	3.5	4.5	5.5	6.5	7.0	7.5	8.5	9.0	
	24m	2.0	3.5	5.0	5.5	6.5	7.5	8.0	9.0	9.5	
	27m	2.0	3.5	5.0	6.0	7.0	7.5	8.5	9.5	10.0	
	30m	2.0	3.5	5.0	6.0	7.0	8.0	9.0	9.5	10.5	
	40m	2.0	3.5	5.5	6.5	7.5	8.5	9.5	10.5	11.5	
	50m	2.0	4.0	5.5	6.5	8.0	9.0	10.0	11.5	12.5	
	60m	2.0	4.0	5.5	7.0	8.0	9.5	11.0	11.5	13.0	
	80m	2.0	4.0	5.5	7.0	8.5	10.0	11.5	12.5	13.5	
	100m	2.0	4.0	5.5	7.0	8.5	10.0	11.5	12.5	14.5	
	120m	2.0	4.0	5.5	7.0	8.5	10.0	11.5	12.5	14.5	
No limit	2.0	4.0	5.5	7.0	8.5	10.5	12.0	12.5	15.0		
12 metres	3m	1.0	1.5	2.0	2.0	2.5	3.0	3.0	3.5	3.5	
	6m	1.5	2.5	3.0	3.5	4.0	4.5	5.0	5.0	5.5	
	9m	1.5	3.0	3.5	4.5	5.0	5.5	6.0	6.5	7.0	
	12m	1.5	3.5	4.5	5.0	6.0	6.5	7.0	7.5	8.0	
	15m	2.0	3.5	5.0	5.5	6.5	7.0	8.0	8.5	9.0	
	18m	2.5	4.0	5.0	6.0	7.0	7.5	8.5	9.0	10.0	
	21m	2.5	4.0	5.5	6.5	7.5	8.5	9.0	10.0	10.5	
	24m	2.5	4.5	6.0	7.0	8.0	8.5	9.5	10.5	11.5	
	27m	2.5	4.5	6.0	7.0	8.0	9.0	10.5	11.0	12.0	
	30m	2.5	4.5	6.5	7.5	8.5	9.5	10.5	11.5	12.5	
	40m	2.5	5.0	6.5	8.0	9.5	10.5	12.0	12.0	14.0	
	50m	2.5	5.0	7.0	8.5	10.0	11.0	13.0	14.0	15.0	
	60m	2.5	5.0	7.0	9.0	10.5	12.0	13.5	14.5	16.0	
	80m	2.5	5.0	7.0	9.0	11.0	13.0	14.5	16.0	17.0	
	100m	2.5	5.0	7.5	9.5	11.5	13.5	15.0	16.5	18.0	
	120m	2.5	5.0	7.5	9.5	11.5	13.5	15.0	17.0	18.5	
No limit	2.5	5.0	7.5	9.5	12.0	14.0	15.5	17.0	19.0		

TABLE 1 - BUILDINGS OR COMPARTMENTS OF PG I, PG II, PG III, PG IV, PG VII & PG VIII (for Open-sided Car Parking Decks only) (cont'd)

Enclosing Rectangle	Distance (in metres) from Relevant Boundary for Unprotected Percentage not exceeding													
	20%	30%	40%	50%	60%	70%	80%	90%	100%					
15 metres	Ht.	Width	3m	1.0	1.5	2.0	2.5	2.5	3.0	3.5	3.5	3.5	3.5	4.0
			6m	1.5	2.5	3.0	4.0	4.5	5.0	5.0	5.5	5.5	5.5	6.0
			9m	2.0	3.0	4.0	5.0	5.5	6.0	6.0	6.5	6.5	7.0	7.5
			12m	2.0	3.5	5.0	5.5	6.5	7.0	7.0	8.0	8.0	8.5	9.0
			15m	2.0	4.0	5.5	6.5	7.0	8.0	8.0	9.0	9.0	9.5	10.0
			18m	2.5	4.5	6.0	7.0	8.0	8.5	9.5	10.5	10.5	10.5	11.0
			21m	2.5	5.0	6.5	7.5	8.5	9.5	10.0	11.0	11.0	11.0	12.0
			24m	3.0	5.0	6.5	8.0	9.0	10.0	10.0	11.0	11.0	12.0	13.0
			27m	3.0	5.5	7.0	8.5	9.5	10.5	10.5	11.5	11.5	12.5	13.5
			30m	3.0	5.5	7.5	8.5	10.0	11.0	11.0	12.0	12.0	13.5	14.0
			40m	3.0	6.0	8.0	9.5	11.0	12.5	12.5	13.5	13.5	15.0	16.0
			50m	3.5	6.0	8.5	10.0	12.0	13.5	13.5	15.0	15.0	16.5	17.5
			60m	3.5	6.5	8.5	10.5	12.5	14.0	14.0	15.5	15.5	17.0	18.0
			80m	3.5	6.5	9.0	11.0	13.5	15.0	15.0	17.0	17.0	18.5	20.0
			100m	3.5	6.5	9.0	11.5	14.0	16.0	16.0	18.0	18.0	19.5	21.5
		120m	3.5	6.5	9.0	11.5	14.0	16.5	16.5	18.5	18.5	20.5	22.5	
		No limit	3.5	6.5	9.0	12.0	14.5	17.0	17.0	19.0	19.0	21.0	23.0	
18 metres			3m	1.0	1.5	2.0	2.5	2.5	3.0	3.5	3.5	3.5	4.0	
			6m	1.5	2.5	3.5	4.0	4.5	5.0	5.0	5.5	5.5	6.0	
			9m	2.0	3.5	4.5	5.0	6.0	6.5	6.5	7.0	7.0	8.0	
			12m	2.5	4.0	5.0	6.0	7.0	7.5	7.5	8.5	8.5	9.0	
			15m	2.5	4.5	6.0	7.0	8.0	8.5	8.5	9.5	9.5	10.5	
			18m	2.5	5.0	6.5	7.5	8.5	9.5	9.5	11.0	11.0	13.0	
			21m	3.0	5.5	7.0	8.0	9.5	10.5	10.5	11.5	11.5	13.0	
			24m	3.0	5.5	7.5	8.5	10.0	11.0	11.0	12.0	12.0	14.0	
			27m	3.5	6.0	8.0	9.0	10.5	11.5	11.5	12.5	12.5	14.5	
			30m	3.5	6.5	8.0	9.5	11.0	12.0	12.0	13.5	13.5	15.5	
			40m	4.0	7.0	9.0	11.0	12.0	13.5	13.5	15.0	15.0	17.5	
			50m	4.0	7.0	9.5	11.5	13.0	14.0	14.0	16.5	16.5	19.0	
			60m	4.0	7.5	10.0	12.0	14.0	16.0	16.0	17.5	17.5	20.5	
			80m	4.0	7.5	10.0	13.0	15.0	17.0	17.0	19.0	19.0	22.5	
			100m	4.0	7.5	10.0	13.5	16.0	18.0	18.0	20.5	20.5	24.0	
		120m	4.0	7.5	10.0	14.0	16.5	19.0	19.0	21.0	21.0	25.5		
		No limit	4.0	8.0	10.0	14.0	17.0	19.5	19.5	22.0	22.0	26.5		

TABLE 1 - BUILDINGS OR COMPARTMENTS OF PG I, PG II, PG III, PG IV, PG VII & PG VIII (for Open-sided Car Parking Decks only) (cont'd)

Enclosing Rectangle		Distance (in metres) from Relevant Boundary for Unprotected Percentage not exceeding									
Ht.	Width	20%	30%	40%	50%	60%	70%	80%	90%	100%	
21 metres	3m	0.5	1.5	2.0	2.5	3.0	3.0	3.5	4.0	4.5	
	6m	1.5	2.5	3.5	4.0	5.0	5.5	6.0	6.5	7.0	
	9m	2.0	3.5	4.5	5.5	6.5	7.0	7.5	8.5	9.0	
	12m	2.5	4.0	5.5	6.5	7.5	8.5	9.0	10.0	10.5	
	15m	2.5	5.0	6.5	7.5	8.5	9.5	10.5	11.0	12.0	
	18m	3.0	5.5	7.0	8.0	9.5	10.5	11.5	12.5	13.0	
	21m	3.0	6.0	7.5	9.0	10.5	11.0	12.5	13.5	14.0	
	24m	3.5	6.0	8.0	9.5	10.5	12.0	13.0	14.0	15.0	
	27m	3.5	6.5	8.5	10.0	11.5	13.0	14.0	15.0	16.0	
	30m	4.0	7.0	9.0	10.5	12.0	13.0	14.5	16.0	16.5	
	40m	4.5	7.5	10.0	12.0	13.5	15.0	16.5	18.0	19.0	
	50m	4.5	8.0	11.0	13.0	14.5	16.5	18.0	20.0	21.0	
	60m	4.5	8.5	11.5	13.5	15.5	17.5	19.5	21.0	22.5	
	80m	4.5	8.5	12.0	14.5	17.0	19.0	21.0	23.5	25.0	
	100m	4.5	9.0	12.0	15.5	18.0	20.5	22.5	25.0	27.0	
120m	4.5	9.0	12.0	16.0	18.5	21.5	23.5	26.5	28.5		
No limit	4.5	9.0	12.0	16.0	19.0	22.0	25.0	26.5	29.5		
24 metres	3m	0.5	1.5	2.0	2.5	3.0	3.5	3.5	4.0	4.5	
	6m	1.5	2.5	3.5	4.5	5.0	5.5	6.0	7.0	7.0	
	9m	2.0	3.5	5.0	5.5	6.5	7.5	8.0	9.0	9.5	
	12m	2.5	4.5	6.0	7.0	8.0	8.5	9.5	10.5	11.5	
	15m	3.0	5.0	6.5	8.0	9.0	10.0	11.0	12.0	13.0	
	18m	3.0	5.5	7.5	8.5	10.0	11.0	12.0	13.0	14.0	
	21m	3.5	6.0	8.0	9.5	10.5	12.0	13.0	14.0	15.0	
	24m	3.5	6.5	8.5	10.0	11.5	12.5	14.0	15.0	16.0	
	27m	4.0	7.0	9.0	11.0	12.5	13.5	15.0	16.0	17.0	
	30m	4.0	7.5	9.5	11.5	13.0	14.0	15.5	17.0	18.0	
	40m	4.5	8.5	11.0	13.0	14.5	16.0	18.0	19.0	20.5	
	50m	5.0	9.0	12.0	14.0	16.0	17.5	19.5	21.0	22.5	
	60m	5.0	9.5	12.5	15.0	17.0	19.0	21.0	23.0	24.5	
	80m	5.0	10.0	13.5	16.5	18.5	21.0	23.5	25.5	27.5	
	100m	5.0	10.0	13.5	17.0	20.0	22.5	25.0	27.5	29.5	
120m	5.5	10.0	13.5	17.5	20.5	23.5	26.5	29.0	31.0		
No limit	5.5	10.0	13.5	18.0	21.0	24.0	27.5	30.0	32.5		

TABLE 1 - BUILDINGS OR COMPARTMENTS OF PG I, PG II, PG III, PG IV, PG VII & PG VIII (for Open-sided Car Parking Decks only) (cont'd)

Enclosing Rectangle		Distance (in metres) from Relevant Boundary for Unprotected Percentage not exceeding									
Ht.	Width	20%	30%	40%	50%	60%	70%	80%	90%	100%	
27 metres	3m	1.0	1.5	2.0	2.5	3.0	3.5	4.0	4.0	4.5	
	6m	1.5	2.5	3.5	4.5	5.0	6.0	6.5	7.0	7.5	
	9m	2.0	3.5	5.0	6.0	7.0	7.5	8.5	9.5	10.0	
	12m	2.5	4.5	6.0	7.0	8.0	9.0	10.5	11.0	12.0	
	15m	3.0	5.5	7.0	8.5	9.5	10.5	11.5	12.5	13.5	
	18m	3.5	6.0	8.0	9.0	10.5	11.5	12.5	13.5	14.5	
	21m	3.5	6.5	8.5	10.0	11.5	13.0	14.0	15.0	16.0	
	24m	3.5	7.0	9.0	11.0	12.5	13.5	15.0	16.0	17.0	
	27m	4.0	7.5	10.0	11.5	13.0	14.0	16.0	17.0	18.0	
	30m	4.0	8.0	10.0	12.0	13.5	15.0	17.0	18.0	19.0	
	40m	5.0	9.0	11.5	14.0	15.5	17.5	19.0	20.5	22.0	
	50m	5.5	9.5	12.5	15.0	17.0	19.0	21.0	22.5	24.0	
	60m	5.5	10.5	13.5	16.0	18.5	20.5	22.5	24.5	26.5	
	80m	6.0	11.0	14.5	17.5	20.5	22.5	25.0	27.5	29.5	
	100m	6.0	11.0	15.5	19.0	21.5	24.5	27.0	30.0	32.0	
	120m	6.0	11.5	15.5	19.5	22.5	26.0	28.5	32.0	34.0	
No limit	6.0	11.5	15.5	20.0	23.5	27.0	29.5	33.0	35.0		

TABLE 2 - BUILDINGS OR COMPARTMENTS OF PG V, PG VI, & PG VIII (see Table 1 for Open-sided Car Parking Decks)

Enclosing Rectangle		Distance (in metres) from Relevant Boundary for Unprotected Percentage not exceeding									
Ht.	Width	20%	30%	40%	50%	60%	70%	80%	90%	100%	
3 metres	3m	1.0	1.5	2.0	2.0	2.5	2.5	2.5	3.0	3.0	
	6m	1.5	2.0	2.5	3.0	3.0	3.5	3.5	4.0	4.0	
	9m	1.5	2.5	3.0	3.5	4.0	4.0	4.5	5.0	5.0	
	12m	2.0	2.5	3.0	3.5	4.0	4.5	5.0	5.5	5.5	
	15m	2.0	2.5	3.5	4.0	4.5	5.0	5.5	6.0	6.0	
	18m	2.0	2.5	3.5	4.0	5.0	5.0	6.0	6.5	6.5	
	21m	2.0	3.0	3.5	4.5	5.0	5.5	6.0	6.5	7.0	
	24m	2.0	3.0	3.5	4.5	5.0	5.5	6.0	7.0	7.5	
	27m	2.0	3.0	4.0	4.5	5.5	6.0	6.5	7.0	7.5	
	30m	2.0	3.0	4.0	4.5	5.5	6.0	6.5	7.5	8.0	
	40m	2.0	3.0	4.0	5.0	5.5	6.5	7.0	8.0	8.5	
	50m	2.0	3.0	4.0	5.0	6.0	6.5	7.5	8.0	9.0	
	60m	2.0	3.0	4.0	5.0	6.0	7.0	7.5	8.5	9.5	
	80m	2.0	3.0	4.0	5.0	6.0	7.0	8.0	9.0	9.5	
No limit	2.0	3.0	4.0	5.0	6.0	7.0	8.0	9.0	10.0		
6 metres	3m	1.5	2.0	2.5	3.0	3.0	3.5	3.5	4.0	4.0	
	6m	2.0	3.0	3.5	4.0	4.5	5.0	5.5	5.5	6.0	
	9m	2.5	3.5	4.5	5.0	5.5	6.0	6.5	7.0	7.0	
	12m	3.0	4.0	5.0	5.5	6.5	7.0	7.5	8.0	8.5	
	15m	3.0	4.5	5.5	6.0	7.0	7.5	8.0	9.0	9.0	
	18m	3.5	4.5	5.5	6.5	7.5	8.0	9.0	9.5	10.0	
	21m	3.5	5.0	6.0	7.0	8.0	9.0	9.5	10.0	10.5	
	24m	3.5	5.0	6.0	7.0	8.5	9.5	10.0	10.5	11.0	
	27m	3.5	5.0	6.5	7.5	8.5	9.5	10.5	11.0	12.0	
	30m	3.5	5.0	6.5	8.0	9.0	10.0	11.0	12.0	12.5	
	40m	3.5	5.5	7.0	8.5	10.0	11.0	12.0	13.0	14.0	
	50m	3.5	5.5	7.5	9.0	10.5	11.5	13.0	14.0	15.0	
	60m	3.5	5.5	7.5	9.5	11.0	12.0	13.5	15.0	16.0	
	80m	3.5	6.0	7.5	9.5	11.5	13.0	14.5	16.0	17.5	
100m	3.5	6.0	8.0	10.0	12.0	13.5	15.0	16.5	18.0		
120m	3.5	6.0	8.0	10.0	12.0	14.0	15.5	17.0	19.0		
No limit	3.5	6.0	8.0	10.0	12.0	14.0	16.0	18.0	19.0		

TABLE 2 - BUILDINGS OR COMPARTMENTS OF PG V, PG VI, & PG VIII (see Table 1 for Open-sided Car Parking Decks) (cont'd)

Enclosing Rectangle		Distance (in metres) from Relevant Boundary for Unprotected Percentage not exceeding									
Ht.	Width	20%	30%	40%	50%	60%	70%	80%	90%	100%	
9 metres	3m	1.5	2.5	3.0	3.5	4.0	4.0	4.5	5.0	5.0	
	6m	2.5	3.5	4.5	5.0	5.5	6.0	6.5	7.0	7.0	
	9m	3.5	4.5	5.5	6.0	6.5	7.5	8.0	8.5	9.0	
	12m	3.5	5.0	6.0	7.0	7.5	8.5	9.0	9.5	10.5	
	15m	4.0	5.5	6.5	7.5	8.5	9.5	10.0	11.0	11.5	
	18m	4.5	6.0	7.0	8.5	9.5	10.0	11.0	12.0	12.5	
	21m	4.5	6.5	7.5	9.0	10.0	11.0	12.0	13.0	13.5	
	24m	5.0	6.5	8.0	9.5	11.0	12.0	13.0	13.5	14.5	
	27m	5.0	7.0	8.5	10.0	11.5	12.5	13.5	14.5	15.0	
	30m	5.0	7.0	9.0	10.5	12.0	13.0	14.0	15.0	16.0	
	40m	5.5	7.5	9.5	11.5	13.0	14.5	15.5	17.0	17.5	
	50m	5.5	8.0	10.0	12.5	14.0	15.5	17.0	18.5	19.5	
	60m	5.5	8.0	11.0	13.0	15.0	16.5	18.0	19.5	21.0	
	80m	5.5	8.5	11.5	13.5	16.0	17.5	19.5	21.5	23.0	
100m	5.5	8.5	11.5	14.5	16.5	18.5	21.0	22.5	24.5		
120m	5.5	8.5	11.5	14.5	17.0	19.5	21.5	23.5	26.0		
No limit	5.5	8.5	11.5	15.0	17.5	20.0	22.5	24.5	27.0		
12 metres	3m	2.0	2.5	3.0	3.5	4.0	4.5	5.0	5.5	5.5	
	6m	3.0	4.0	5.0	5.5	6.5	7.0	7.5	8.0	8.5	
	9m	3.5	5.0	6.0	7.0	7.5	8.5	9.0	9.5	10.5	
	12m	4.5	6.0	7.0	8.0	9.0	9.5	11.0	11.5	12.0	
	15m	5.0	6.5	8.0	9.0	10.0	11.0	12.0	13.0	13.5	
	18m	5.0	7.0	8.5	10.0	11.0	12.0	13.0	14.0	14.5	
	21m	5.5	7.5	9.0	10.5	12.0	13.0	14.0	15.0	16.0	
	24m	6.0	8.0	9.5	11.5	12.5	14.0	15.0	16.0	16.5	
	27m	6.0	8.0	10.5	12.0	13.5	14.5	16.0	17.0	17.5	
	30m	6.5	8.5	10.5	12.5	14.0	15.0	16.5	17.5	18.5	
	40m	6.5	9.5	12.0	14.0	15.5	17.5	18.5	20.0	21.0	
	50m	7.0	10.0	13.0	15.0	17.0	19.0	20.5	23.0	23.0	
	60m	7.0	10.5	13.5	16.0	18.0	20.0	21.5	23.5	25.0	
	80m	7.0	11.0	14.5	17.0	19.5	21.5	23.5	26.0	27.5	
100m	7.5	11.5	15.0	18.0	21.0	23.0	25.5	28.0	30.0		
120m	7.5	11.5	15.0	18.5	22.0	24.0	27.0	29.5	31.5		
No limit	7.5	12.0	15.5	19.0	22.5	25.0	28.0	30.5	34.0		

TABLE 2 - BUILDINGS OR COMPARTMENTS OF PG V, PG VI, & PG VIII (see Table 1 for Open-sided Car Parking Decks) (cont'd)

Enclosing Rectangle		Distance (in metres) from Relevant Boundary for Unprotected Percentage not exceeding									
Ht.	Width	20%	30%	40%	50%	60%	70%	80%	90%	100%	
15 metres	3m	2.0	2.5	3.5	4.0	4.5	5.0	5.5	6.0	6.0	
	6m	3.0	4.5	5.5	6.0	7.0	7.5	8.0	9.0	9.0	
	9m	4.0	5.5	6.5	7.5	8.5	9.5	10.0	11.0	11.5	
	12m	5.0	6.5	8.0	9.0	10.0	11.0	12.0	13.0	13.5	
	15m	5.5	7.0	9.0	10.0	11.5	12.5	13.5	14.5	15.0	
	18m	6.0	8.0	9.5	11.0	12.5	13.5	14.5	15.5	16.5	
	21m	6.5	8.5	10.5	12.0	13.5	14.5	16.0	16.5	17.5	
	24m	6.5	9.0	11.0	13.0	14.5	15.5	17.0	18.0	19.0	
	27m	7.0	9.5	11.5	13.5	15.0	16.5	18.0	19.0	20.0	
	30m	7.5	10.0	12.0	14.0	16.0	17.0	18.5	20.0	21.0	
	40m	8.0	11.0	13.5	16.0	18.0	19.5	21.0	22.5	23.5	
	50m	8.5	12.0	15.0	17.5	19.5	21.5	23.0	25.0	26.0	
	60m	8.5	12.5	15.5	18.0	21.0	23.5	25.0	27.0	28.0	
	80m	9.0	13.5	17.0	20.0	23.0	25.5	28.0	30.0	31.5	
100m	9.0	14.0	18.0	21.5	24.5	27.5	30.0	32.5	34.5		
120m	9.0	14.0	18.5	22.5	25.5	28.5	31.5	34.5	37.0		
No limit	9.0	14.5	19.0	23.0	27.0	30.0	34.0	36.0	39.0		
18 metres	3m	2.0	2.5	3.5	4.0	5.0	5.0	6.0	6.5	6.5	
	6m	3.5	4.5	5.5	6.5	7.5	8.0	9.0	9.5	10.0	
	9m	4.5	6.0	7.0	8.5	9.5	10.0	11.0	12.0	12.5	
	12m	5.0	7.0	8.5	10.0	11.0	12.0	13.0	14.0	14.5	
	15m	6.0	8.0	9.5	11.0	12.5	13.5	14.5	15.5	16.5	
	18m	6.5	8.5	11.0	12.0	13.5	14.5	16.0	17.0	18.0	
	21m	7.0	9.5	11.5	13.0	14.5	16.0	17.0	18.0	19.5	
	24m	7.5	10.0	12.0	14.0	15.5	16.5	18.5	19.5	20.5	
	27m	8.0	10.5	12.5	14.5	16.5	17.5	19.5	20.5	21.5	
	30m	8.0	11.0	13.5	15.5	17.0	18.5	20.5	21.5	22.5	
	40m	9.0	12.0	15.0	17.5	19.5	21.5	23.5	25.0	26.0	
	50m	9.5	13.0	16.5	19.0	21.5	23.5	26.0	27.5	29.0	
	60m	10.0	14.0	17.5	20.5	23.0	26.0	27.5	29.5	31.0	
	80m	10.0	15.0	19.0	22.5	26.0	28.5	31.0	33.5	35.0	
100m	10.0	16.0	20.5	24.0	28.0	31.0	33.5	36.0	38.5		
120m	10.0	16.5	21.0	25.5	29.5	32.5	35.5	39.0	41.5		
No limit	10.0	17.0	22.0	26.5	30.5	34.0	37.0	41.0	43.5		

TABLE 2 - BUILDINGS OR COMPARTMENTS OF PG V, PG VI, & PG VIII (see Table 1 for Open-sided Car Parking Decks) (cont'd)

Enclosing Rectangle		Distance (in metres) from Relevant Boundary for Unprotected Percentage not exceeding									
Ht.	Width	20%	30%	40%	50%	60%	70%	80%	90%	100%	
21 metres	3m	2.0	3.0	3.5	4.5	5.0	5.5	6.0	6.5	7.0	
	6m	3.5	5.0	6.0	7.0	8.0	9.0	9.5	10.0	10.5	
	9m	4.5	6.5	7.5	9.0	10.0	11.0	12.0	13.0	13.5	
	12m	5.5	7.5	9.0	10.5	12.0	13.0	14.0	15.0	16.0	
	15m	6.5	8.5	10.5	12.0	13.5	14.5	16.0	16.5	17.5	
	18m	7.0	9.5	11.5	13.0	14.5	16.0	17.0	18.0	19.5	
	21m	7.5	10.0	12.5	14.0	15.5	17.0	18.5	20.0	21.0	
	24m	8.0	10.5	13.0	15.0	16.0	18.0	20.0	21.0	22.0	
	27m	8.5	11.5	14.0	16.0	18.0	19.0	21.0	22.5	23.5	
	30m	9.0	12.0	14.5	16.5	18.5	20.5	22.0	23.5	25.0	
	40m	10.0	13.5	16.5	19.0	21.5	23.0	25.5	27.0	28.5	
	50m	11.0	14.5	18.0	21.0	23.5	25.5	28.0	30.0	31.5	
	60m	11.5	15.5	19.5	22.5	25.5	28.0	30.5	32.5	33.5	
	80m	12.0	17.0	21.0	25.0	28.5	31.5	34.0	36.5	38.5	
	100m	12.0	18.0	22.5	27.0	31.0	34.5	37.0	40.0	42.0	
	120m	12.0	18.5	23.5	28.5	32.5	36.5	39.5	43.0	45.5	
No limit	12.0	19.0	25.0	29.5	34.5	38.0	41.5	45.5	48.0		
24 metres	3m	2.0	3.0	3.5	4.5	5.0	5.5	6.0	7.0	7.5	
	6m	3.5	5.0	6.0	7.0	8.5	9.5	10.0	10.5	11.0	
	9m	5.0	6.5	8.0	9.5	11.0	12.0	13.0	13.5	14.5	
	12m	6.0	8.0	9.5	11.5	12.5	14.0	15.0	16.0	16.5	
	15m	6.5	9.0	11.0	13.0	14.5	15.5	17.0	18.0	19.0	
	18m	7.5	10.0	12.0	14.0	15.5	16.5	18.5	19.5	20.5	
	21m	8.0	10.5	13.0	15.0	16.5	18.0	20.0	21.0	22.0	
	24m	8.5	11.5	14.0	16.0	18.0	19.5	21.0	22.5	24.0	
	27m	9.0	12.5	15.0	17.0	19.0	20.5	21.5	24.0	25.5	
	30m	9.5	13.0	15.5	18.0	20.0	21.5	23.5	25.0	26.5	
	40m	11.0	14.5	18.0	20.5	23.0	25.0	27.5	29.0	30.5	
	50m	12.0	16.0	19.5	22.5	25.5	27.5	30.0	32.0	33.5	
	60m	12.5	17.0	21.0	24.5	27.5	30.0	32.5	35.0	36.5	
	80m	13.5	18.5	23.5	27.5	31.0	34.5	37.0	39.5	41.5	
	100m	13.5	20.0	25.0	29.5	33.5	37.0	40.0	43.0	45.5	
	120m	13.5	20.5	26.5	31.0	36.0	39.5	43.0	46.5	49.0	
No limit	13.5	21.0	27.5	32.5	37.5	42.0	45.5	49.5	52.0		

ANNEX 3B

TABLE 2 - BUILDINGS OR COMPARTMENTS OF PG V, PG VI, & PG VIII (see Table 1 for Open-sided Car Parking Decks) (cont'd)

Enclosing Rectangle		Distance (in metres) from Relevant Boundary for Unprotected Percentage not exceeding									
Ht.	Width	20%	30%	40%	50%	60%	70%	80%	90%	100%	
27 metres	3m	2.0	3.0	4.0	4.5	5.5	6.0	6.5	7.0	7.5	
	6m	3.5	5.0	6.5	7.5	8.5	9.5	10.5	11.0	12.0	
	9m	5.0	7.0	8.5	10.0	11.5	12.5	13.5	14.5	15.0	
	12m	6.0	8.0	10.5	12.0	13.5	14.5	16.0	17.0	17.5	
	15m	7.0	9.5	11.5	13.5	15.0	16.5	18.0	19.0	20.0	
	18m	8.0	10.5	12.5	14.5	16.5	17.5	19.5	20.5	21.5	
	21m	8.5	11.5	14.0	16.0	18.0	19.0	21.0	22.5	23.5	
	24m	9.0	12.5	15.0	17.0	19.0	20.5	22.5	24.0	25.5	
	27m	10.0	13.0	16.0	18.0	20.0	22.0	24.0	25.5	27.0	
	30m	10.0	13.5	17.0	19.0	21.0	23.0	25.0	26.5	28.0	
	40m	11.5	15.5	19.0	22.0	24.5	26.5	29.0	30.5	32.5	
	50m	12.5	17.0	21.0	24.0	27.0	29.5	32.0	34.5	36.0	
	60m	13.5	18.5	22.5	26.5	29.5	32.0	35.0	37.0	39.0	
	80m	14.5	20.5	25.0	29.5	33.0	36.5	39.5	42.0	44.0	
	100m	15.5	21.5	27.0	32.0	36.5	40.5	43.0	46.5	48.5	
120m	15.5	22.5	28.5	34.0	39.0	43.0	46.5	50.5	53.0		
No limit	15.5	23.5	29.5	35.0	40.5	44.5	48.5	52.0	55.5		

TABLE 3
Percentage of the Width of the Unprotected Openings upon their Projection onto the Plane of Reference
 (in view of distance of the openings from the plane of reference)

Width of Unprotected Opening*	DISTANCE TO REFERENCE PLANE																										
	1M	2M	3M	4M	5M	6M	7M	8M	9M	10M	11M	12M	13M	14M	15M	16M	17M	18M	19M	20M	21M	22M	23M	24M	25M	26M	27M
3m	72%	54%	41%	33%	28%	24%	21%	18%	16%	15%	13%	12%	11%	11%	10%	9%	9%	8%	8%	7%	7%	7%	6%	6%	6%	6%	6%
6m	85%	72%	62%	54%	47%	41%	37%	33%	30%	28%	25%	24%	22%	21%	19%	18%	17%	16%	15%	15%	14%	13%	13%	12%	12%	11%	11%
9m	90%	80%	72%	65%	59%	54%	49%	45%	41%	38%	36%	33%	31%	29%	28%	26%	25%	24%	22%	21%	21%	20%	19%	18%	17%	17%	16%
15m	94%	88%	82%	77%	72%	68%	64%	60%	57%	54%	51%	48%	46%	43%	41%	40%	38%	36%	35%	33%	32%	31%	30%	29%	28%	27%	26%
21m	95%	91%	87%	83%	79%	75%	72%	69%	66%	63%	61%	58%	56%	54%	51%	50%	48%	46%	44%	43%	41%	40%	39%	38%	36%	35%	34%
27m	96%	93%	90%	86%	83%	80%	77%	75%	72%	70%	67%	65%	63%	61%	59%	57%	55%	54%	52%	50%	49%	48%	46%	45%	44%	43%	41%
30m	97%	94%	90%	88%	85%	82%	79%	77%	74%	72%	70%	68%	66%	64%	62%	60%	58%	57%	55%	54%	52%	51%	49%	48%	47%	46%	45%
40m	98%	95%	93%	90%	88%	86%	84%	82%	80%	78%	76%	74%	73%	71%	69%	68%	66%	65%	63%	62%	60%	59%	58%	57%	55%	54%	53%
50m	98%	96%	94%	92%	90%	89%	87%	85%	84%	82%	80%	79%	77%	76%	74%	73%	72%	70%	69%	68%	66%	66%	64%	63%	62%	61%	60%
60m	98%	97%	95%	94%	92%	90%	89%	88%	86%	85%	83%	82%	81%	79%	78%	77%	76%	74%	73%	72%	71%	70%	69%	68%	67%	66%	65%
70m	99%	97%	96%	94%	93%	92%	90%	89%	88%	87%	86%	84%	83%	82%	81%	80%	79%	78%	76%	75%	74%	73%	72%	71%	70%	70%	69%
80m	99%	98%	96%	95%	94%	93%	92%	90%	89%	88%	87%	86%	85%	84%	83%	82%	81%	80%	79%	78%	77%	76%	75%	74%	73%	72%	72%
90m	99%	98%	97%	96%	95%	94%	93%	92%	90%	90%	89%	88%	87%	86%	85%	84%	83%	82%	81%	80%	80%	79%	78%	77%	76%	75%	74%
100m	99%	98%	97%	96%	95%	94%	93%	92%	91%	90%	90%	89%	88%	87%	86%	85%	84%	83%	82%	82%	81%	80%	80%	79%	78%	77%	77%
110m	99%	98%	97%	96%	96%	95%	94%	93%	92%	91%	90%	90%	89%	88%	87%	86%	85%	84%	83%	83%	82%	81%	81%	80%	80%	79%	78%
120m	99%	98%	98%	97%	96%	95%	94%	94%	93%	92%	91%	90%	90%	89%	88%	87%	86%	85%	84%	84%	83%	83%	82%	82%	81%	81%	80%

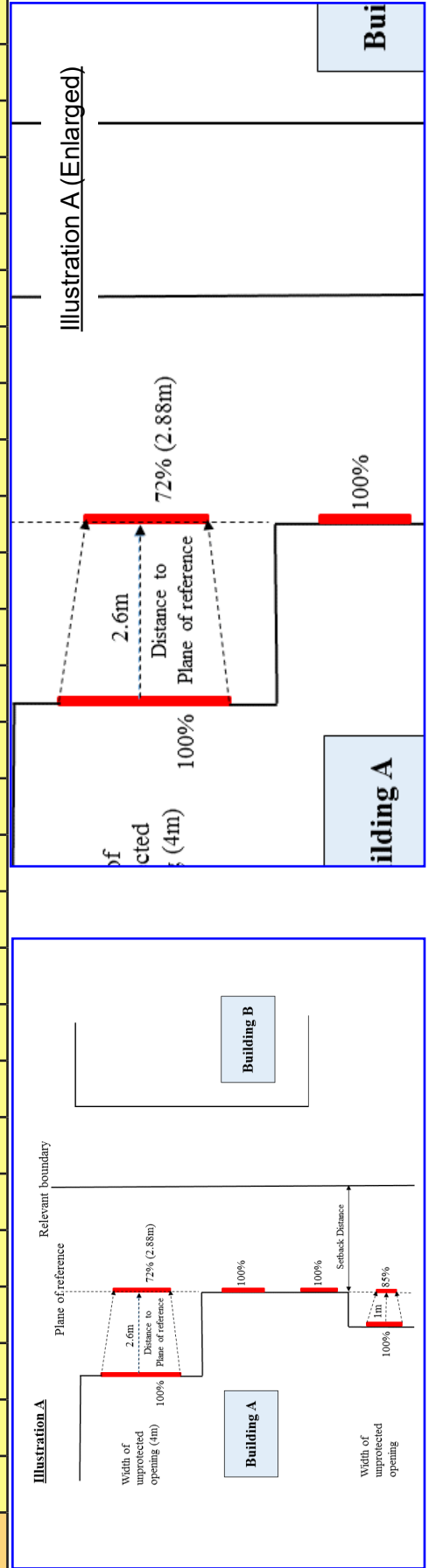

TABLE 3 - (cont'd)
Percentage of the Width of the Unprotected Openings upon their Projection onto the Plane of Reference
(in view of distance of the openings from the plane of reference)

Width of Unprotected Opening*	DISTANCE TO REFERENCE PLANE																										
	28m	29m	30m	31m	32m	33m	34m	35m	36m	37m	38m	39m	40m	41m	42m	43m	44m	45m	46m	47m	48m	49m	50m	51m	52m	53m	54m
3m	5%	5%	5%	5%	5%	5%	4%	4%	4%	4%	4%	4%	4%	4%	4%	3%	3%	3%	3%	3%	3%	3%	3%	3%	3%	3%	3%
6m	11%	10%	10%	10%	9%	9%	8%	8%	8%	8%	8%	8%	7%	7%	7%	7%	7%	7%	6%	6%	6%	6%	6%	6%	6%	6%	6%
9m	16%	15%	15%	14%	14%	13%	13%	13%	12%	12%	12%	11%	11%	11%	11%	10%	10%	10%	10%	9%	9%	9%	9%	9%	9%	8%	8%
15m	25%	24%	24%	23%	22%	22%	21%	21%	20%	19%	19%	19%	18%	18%	17%	17%	17%	16%	16%	16%	15%	15%	15%	14%	14%	14%	14%
21m	33%	32%	32%	31%	30%	29%	28%	28%	27%	26%	26%	25%	25%	24%	24%	23%	23%	22%	22%	21%	21%	21%	20%	20%	19%	19%	19%
27m	40%	39%	38%	37%	37%	36%	35%	34%	33%	33%	32%	31%	31%	30%	29%	29%	28%	28%	27%	27%	26%	26%	25%	25%	24%	24%	24%
30m	43%	42%	41%	40%	40%	39%	38%	37%	36%	35%	35%	34%	33%	33%	32%	31%	31%	30%	30%	29%	29%	28%	28%	27%	27%	26%	26%
40m	52%	51%	50%	49%	48%	47%	46%	45%	45%	44%	43%	42%	41%	41%	40%	39%	39%	38%	37%	37%	36%	36%	35%	35%	34%	34%	33%
50m	59%	58%	57%	56%	55%	54%	53%	52%	51%	50%	50%	49%	48%	47%	46%	45%	45%	44%	43%	43%	42%	42%	41%	41%	40%	40%	39%
60m	64%	63%	62%	61%	60%	59%	58%	57%	56%	55%	55%	54%	53%	52%	51%	51%	50%	50%	49%	49%	48%	47%	47%	46%	46%	45%	45%
70m	68%	67%	66%	65%	64%	63%	63%	62%	61%	60%	59%	59%	58%	57%	56%	56%	55%	55%	54%	54%	53%	53%	52%	51%	51%	50%	49%
80m	71%	70%	69%	68%	68%	67%	66%	65%	65%	64%	63%	63%	62%	61%	60%	60%	59%	58%	58%	57%	57%	56%	56%	55%	54%	54%	53%
90m	74%	73%	72%	71%	71%	70%	69%	68%	68%	67%	66%	66%	65%	64%	64%	63%	62%	62%	61%	61%	60%	60%	59%	59%	58%	57%	57%
100m	76%	75%	74%	74%	73%	72%	72%	71%	70%	70%	69%	68%	68%	67%	66%	66%	65%	65%	64%	64%	63%	63%	62%	62%	61%	61%	60%
110m	78%	77%	76%	76%	75%	74%	74%	73%	72%	72%	71%	71%	70%	69%	68%	68%	67%	67%	66%	66%	65%	65%	64%	64%	63%	63%	62%
120m	79%	79%	78%	77%	77%	76%	76%	75%	74%	74%	73%	73%	72%	72%	71%	70%	70%	69%	69%	68%	68%	67%	67%	66%	66%	65%	65%

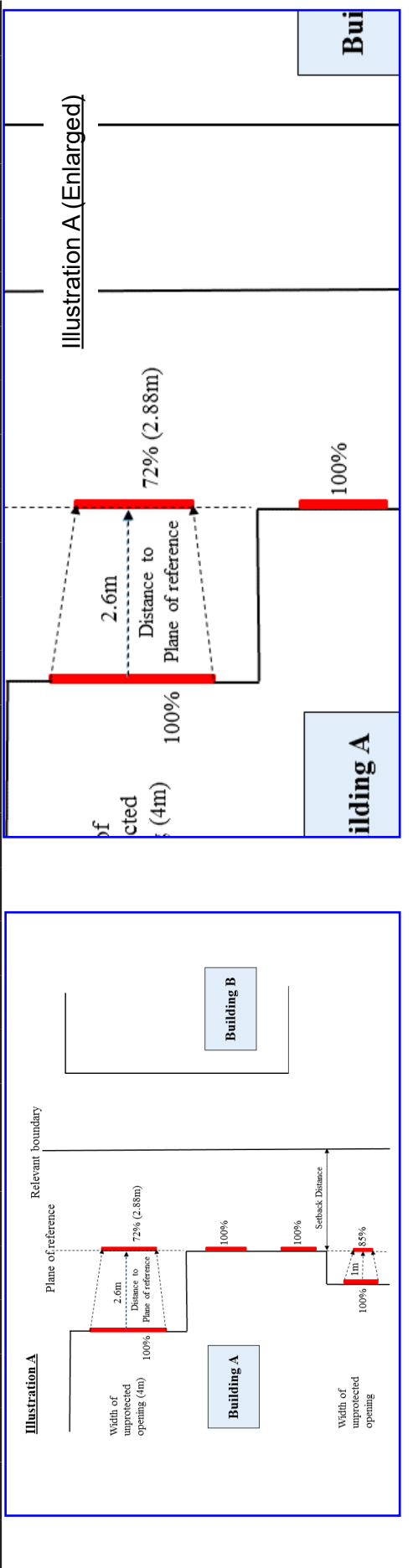
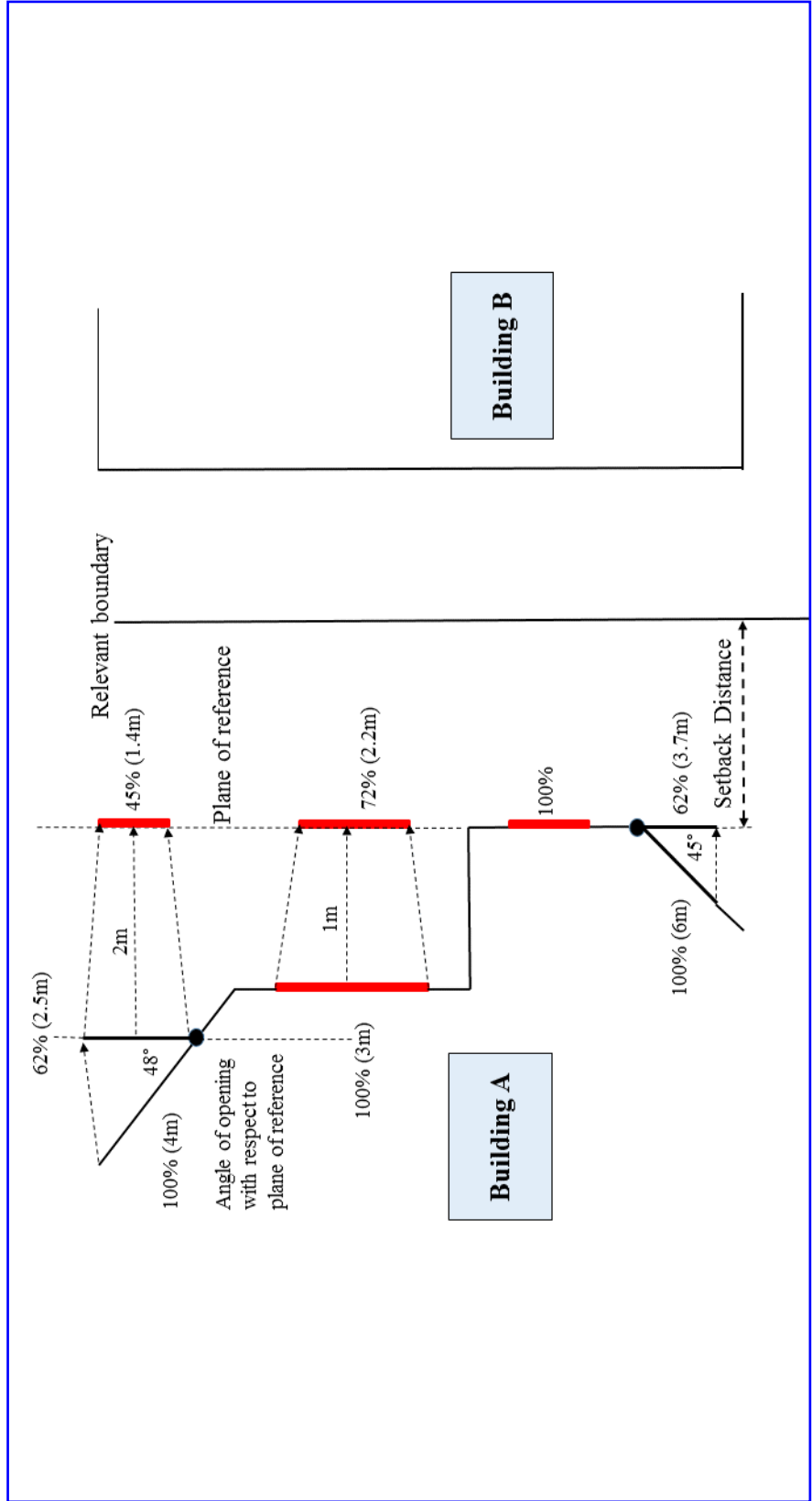

TABLE 4
Percentage of the Width of the Unprotected Openings upon their Projection onto the Plane of Reference
 (in view of distance of the openings from the plane of reference)

Angle of unprotected opening to reference plane*	5°	10°	15°	20°	25°	30°	35°	40°	45°	50°	55°	60°	65°	70°	75°	80°	85°	90°
Actual percentage of unprotected opening width on reference plane	96%	91%	87%	83%	78%	74%	70%	66%	62%	58%	54%	50%	46%	43%	39%	36%	32%	29%



The background of the page is a detailed architectural site plan. It shows various building footprints, streets, and parking areas. Some buildings are labeled with '1st floor', '2nd floor', and '3rd floor'. There are also labels for 'Fire engine road side tank boundary' and 'Fire engine'. The plan is rendered in a light, faded style, providing a technical context for the chapter title.

CHAPTER

04

SITE PLANNING & EXTERNAL FIREFIGHTING PROVISION

CHAPTER

4

SITE PLANNING & EXTERNAL
FIREFIGHTING PROVISION

4.1 GENERAL

The purpose of this Chapter is to make provision for space around buildings to enable effective external firefighting operations.

4.2 PROVISION FOR EXTERNAL ACCESS TO BUILDING FOR FIRE-FIGHTING AND ACCESSIBILITY OF SITE TO FIREFIGHTING APPLIANCES

4.2.1 General

- a. Fire engine accessways/fire engine access roads shall be provided to ensure site accessibility for firefighting appliances.
- b. Fire engine accessways shall have an adequate clear width for the deployment of firefighting appliances, in accordance with the habitable height and the type of building, as stipulated in *Table 4.2A*, *Table 4.2B* and *Table 4.2C*.
- c. Fire engine access roads shall have a clear width of at least 4m.
- d. Fire access openings shall be provided along the external walls of buildings fronting the fire engine accessway to provide access into the building for firefighting and rescue operations.

4.2.2 Fire engine accessway and fire engine access road

a. Provision

(1) PG I and II buildings not exceeding 10m habitable height

A fire engine accessway is not required for the following buildings, however, a fire engine access road for access by firefighting appliances shall be provided to within a travel distance of 60m of every point on the projected plan area of the following buildings:

- (a) PG I buildings;
- (b) PG II buildings of habitable height not exceeding 10m; and
- (c) Cluster housing.

(2) Non-residential standalone buildings within PG II development

Non-residential standalone buildings, such as clubhouses, car parks, etc. (excluding guardhouses and substations) that are located within a PG II housing development, shall comply with *Cl.4.2.2a.(4)*, *Cl.4.2.2a.(5)*, *Cl.4.2.2a.(6)* or *Cl.4.2.2a.(7)*, depending on the habitable heights and usage

of the buildings.

(3) PG II buildings exceeding 10m habitable height

For a building under PG II that exceeds the habitable height of 10m, all of the following shall be complied with:

- (a) A fire engine accessway/fire engine access road shall be provided within a travel distance of 18m to the entrance of all exit staircases where the landing valves (dry or wet riser) are provided.
- (b) A fire engine accessway shall be provided to access at least one entire façade of each block and shall be located at a distance of at least 2m and at most 10m away from the façade of the building.
- (c) The fire engine accessway shall be designed to meet the specifications stipulated in [Table 4.2A](#), [Table 4.2D](#) and [Table 4.2E](#).

(4) PG III, IV, V & VII buildings not exceeding 10m habitable height

For buildings under PG III, IV, V and VII not exceeding the habitable height of 10m, a fire engine accessway is not required. However, a fire engine access road for access by firefighting appliances shall be provided to within a travel distance of 45m of every point on the projected plan area of the building.

(5) Basement

In the case of a basement, the fire engine accessway/fire engine access road shall be provided to within a travel distance of 18m to the entrance of all exit staircases that are provided with landing valves (dry or wet riser) in accordance with [Cl.6.2.2b](#). The measurement of 18m shall be between the fire engine accessway/fire engine access road and the entrance of exit staircase.

(6) PG III, IV, V & VII buildings exceeding 10m habitable height

For buildings under PG III, IV, V and VII exceeding the habitable height of 10m, a fire engine accessway shall be located directly below the fire access openings to provide direct reach to the designated fire access panels. The required length of fire engine accessway shall be computed based on the largest Accessible Floor Area (AFA) of any aboveground floors as follows:

- (a) for interconnected floors, including basements connected to aboveground floors, the AFA shall be the aggregate areas of all the interconnected floors, or
- (b) for buildings with more than one group of interconnected floors, the AFA shall be taken as the largest of the aggregate floor areas among the groups of interconnected floors.

TABLE 4.2.2a.(6) : LENGTH OF FIRE ENGINE ACCESSWAY FOR PG III, IV, V & VII BUILDINGS		
AFA (m ²)	Required length of perimeter	
	Non-sprinkler-protected	Sprinkler-protected
≤ 2000	1/6 (at least 15m)	1/6 (at least 15m)
> 2000 & ≤ 4000	1/4	
> 4000 & ≤ 8000	1/2	1/4
> 8000 & ≤ 16000	3/4	1/2
> 16000 & ≤ 32000	island site	3/4
>32000		island site

(7) PG VI and VIII buildings

For buildings under PG VI and VIII, a fire engine accessway shall be provided for firefighting appliances. The required length of the fire engine accessway shall be calculated based on the following gross cubical extent of the building (excluding basement) as follows:

TABLE 4.2.2a.(7) : LENGTH OF FIRE ENGINE ACCESSWAY FOR PG VI & VIII BUILDINGS		
Cubical Extent (m ³)	Required length of perimeter	
	Non-sprinkler-protected	Sprinkler-protected
≤ 28400	1/6 (at least 15m)	1/6 (at least 15m)
> 28400 & ≤ 56800	1/4	
> 56800 & ≤ 85200	1/2	1/4
> 85200 & ≤ 113600	3/4	1/4
> 113600 & ≤ 170400	island site	1/2
> 170400 & ≤ 227200		3/4
>227200		island site

(8) Mixed-use buildings

- (a) Where the non-residential component of the building occupies only the lower portion of the building, the measurement of habitable height for determining the provisions of a fire engine accessway/fire engine access road shall be based on the non-residential component of the building.
- (b) For mixed-use buildings without PG II usage, the length of fire engine accessway shall be computed based on the following, whichever is larger:
 - (i) the gross cubical extent of the PG VI or VIII usages; or
 - (ii) the larger compartmented floor area, for purpose groups other than PG VI and VIII,
- (c) For mixed-use buildings with PG II usage, the length of fire engine accessway for mixed-use buildings shall be computed based

on *Cl.4.2.2a.(6)* above. In addition, *Cl.4.2.2a.(3)* shall also be complied with.

b. Width of fire engine accessway

The width of fire engine accessway shall be as specified in *Table 4.2A*, *Table 4.2B* and *Table 4.2C*. Such fire engine accessway shall be able to accommodate the entry and manoeuvring of firefighting appliances, and extended ladder firefighting appliances, with turntable and/or hydraulic platforms.

c. Location

The fire engine accessway shall be positioned so that the nearer edge shall be at least 2m or at most 10m from the centre position of the fire access opening, measured horizontally.

d. Gradients of fire engine accessway/fire engine access road

The fire engine accessway shall be laid on a level platform. If on an incline, the gradient shall not exceed 1:15. A fire engine access road shall be laid on an incline not exceeding a gradient of 1:8.3.

e. Turning facilities

- (1) A dead end fire engine accessway/fire engine access road shall not exceed 46m in length. If exceeding 46m, it shall be provided with cul-de-sac turning facility as shown in *Diagram 4.2.2e.*
- (2) The U-turn radii for firefighting appliances on a fire engine accessway/fire engine access road shall comply with the requirements as shown in *Diagram 4.2.2e.*

f. Overhead clearance

An overhead structure shall only be permitted over a fire engine accessway/fire engine access road subject to all of the following (see *Diagram 4.2.2f*):

- (1) the overhead clearance for passage of firefighting appliances shall be at least 4.5m;
- (2) the width of the overhead structure shall not be more than 10m;
- (3) where more than one overhead structure spans across the fire engine accessway/fire engine access road, the separation distance between two adjacent overhead structures shall be at least 20m apart;
- (4) the length of the end-stretch of the fire engine accessway/fire engine access road shall be at least 20m with no overhead structure; and
- (5) the length of fire engine accessway required for the building shall exclude the stretch of fire engine accessway with the overhead structure.

g. Public road

Public roads can serve as a fire engine accessway, provided the location of such

public roads is in compliance with the requirements of distance from fire access openings.

h. Obstruction

Fire engine accessways/fire engine access roads shall be kept clear of obstructions at all times. Plants, trees or other fixtures shall not obstruct the path between the fire engine accessway and fire access openings.

i. Marking of fire engine accessway and fire engine access road

- (1) All corners of fire engine accessway/fire engine access road shall be marked, except where public roads are designated as fire engine accessway/fire engine access road.
- (2) Metalled/non-metalled or paved/non-paved surface fire engine accessways/fire engine access roads shall be marked with reflective white or yellow strips of size not less than 100mm (W) x 400mm (L). The markings shall be visible at night and shall be provided on both sides of the fire engine accessways/fire engine access roads at an interval of not more than 5m.
- (3) A sign post with white background and red wording of not less than 50mm in height shall be provided at the start and end of a fire engine accessway/fire engine access road. The height measured from the ground to the lowest point of the sign shall be between 1m and 1.5m. The sign post shall be visible at night and shall not be positioned more than 3m from the fire engine accessway/fire engine access road. Every part of the fire engine accessway/fire engine access road shall not be more than 15m from the nearest sign post. See *Diagram 4.2.2i.(3)*.

j. Design of fire engine accessway

(1) Fire engine accessway sizes

The minimum width, length and turning radii of a fire engine accessway shall be in accordance with *Table 4.2A*, *Table 4.2B*, *Table 4.2C* and *Diagram 4.2.2e.. Diagram 4.2.2j(1) – 1 to 3* shows the relationship between the fire engine accessway and parked firefighting appliance with its front and rear jacks extended.

- (2) Fire engine accessways and fire engine access roads, which can be on suspended slabs, metalled/non-metalled roads, paved/non-paved surfaces, ground laid with strengthened perforated slabs, etc., shall be designed to withstand both stationary and axle loading capacity of firefighting appliances respectively as stipulated in *Table 4.2D* and *Table 4.2E*. Where a fire engine access road is used for linking fire engine accessway, its loading and turning radius shall comply with the specifications for fire engine accessway.

4.2.3 Fire access opening to building for firefighting

a. **Provision**

Fire access openings shall be provided on the external wall for external firefighting and rescue operations. This can include unobstructed external wall openings, windows, balcony doors, glazed wall panels and access panels. Windows, doors, wall panels or access panels shall be readily openable from the inside and outside. The inside and outside of fire access openings shall be unobstructed at all times during the occupancy of the building. There shall be no furniture or any other obstruction within 1m from the fire access openings at the landing inside the building.

b. **Location**

The fire access opening shall be placed against an occupied space. It shall not be placed at plant/store room, exit staircase, smoke-stop/fire lift lobby or space that leads only to a dead end.

c. **Signage**

Panels to fire access openings shall be indicated with either a red or orange triangle of equal sides (minimum 150mm on each side), which can be upright or inverted, on the external side of the wall and with the wordings "Firefighting Access - Do Not Obstruct" of at least 25mm height on the internal side.

d. **Size**

Fire access openings shall be not less than 850mm wide by 1m high with sill height of not more than 1.1m, and head height not less than 1.8m above the inside floor level.

e. **Number and position of fire access openings for buildings other than residential**

(1) **Number of fire access opening**

For PG III to VIII buildings, the number of fire access opening shall be based on the length of the fire engine accessway. Every 20m of fire engine accessway or part thereof shall be provided with an access panel.

(2) **Position**

Fire access openings shall be remote from each other and located along the side of the building. Such fire access openings shall be spaced at most 20m apart measured along the external wall from centre to centre of the fire access openings. The fire access opening shall be distributed such that there is at least one opening at every 20m of the fire engine accessway, except for parts of the non-PG VI or non-PG VIII building that are single-storey.

(3) **Fire access opening to compartment or spaces**

(a) For buildings under PG III, IV, V and VII exceeding the habitable height of 10m, and up to 90m, fire access openings are required at every storey level, other than the 1st storey, and shall face the fire

engine accessway directly.

- (b) For building under PG VI and VIII, fire engine access openings located over a fire engine accessway shall be provided along the external walls, up to a habitable height of 90m.

(4) Additional openings for ventilation

For buildings under PG III to VIII where an area or space has a ceiling height greater than 10m, additional high level ventilation openings for smoke venting and firefighting purposes shall be provided and located in the external walls opening into the area or space. The ventilation opening shall meet the following criteria:

- (a) the number and location of the openings shall comply with *Cl.4.2.3e.(1)* and *Cl.4.2.3e.(2)*.
- (b) the dimensions of the openings shall comply with *Cl.4.2.3d.*;
- (c) the openings can be in the form of openable panels/louvres, breakable glazing, or permanent openings; and
- (d) the openings shall not be indicated with the triangular signage as mentioned under *Cl.4.2.3c.*, but instead be labelled with red wording, “DO NOT ENTER – FOR SMOKE VENTING ONLY”, of height not less than 50mm and visible from the building exterior.

f. Exemption

The provision of fire access openings shall not be applicable to buildings under PG I and II, including building of non-residential ancillary usage (such as gyms, club rooms, etc.) in a residential building.

4.3 ACCESS TO BUILDINGS WITH RISING MAINS

Buildings fitted with rising mains and automatic sprinkler system shall have fire engine accessway/fire engine access road for firefighting appliances within 18m of breeching inlets. The breeching inlets shall be visible from the fire engine accessways or fire engine access road.

4.4 PRIVATE FIRE HYDRANT

4.4.1 Provision of private fire hydrant

a. General

Every part of a fire engine accessway and/or fire engine access road shall be within an unobstructed distance of 50m from a fire hydrant. Where a public fire hydrant conforming to this requirement is not available, private fire hydrant(s) shall be provided (see *Diagram 4.4.1a.*).

b. Use of public fire hydrant

Existing public fire hydrants along one side of a public road shall not be designated to serve developments sited on the other side of the public road, except for a road having at most two lanes, regardless of traffic direction.

c. Locations of fire hydrants

In situations where more than one private fire hydrants is required, the fire hydrants shall be located along the fire engine accessway/fire engine access road such that every part of the fire engine accessway/fire engine access road is within an unobstructed distance of 50m from any fire hydrant (see *Diagram 4.4.1c.*).

d. Siting and types of fire hydrants

Siting and types of fire hydrants shall comply with the requirements stated in SS 575.

e. Ringed fire hydrant pipes

For a building that is required to have an island site fire engine accessway under *Cl.4.4.2b.*, the fire hydrant pipe shall be a ring system. Isolation valves shall be provided on the fire hydrant ring such that individual fire hydrant can be isolated when required for maintenance without affecting the water supply (both designed pressure and flow) to the other fire hydrants on the ring.

f. Valve locking device

A locking device shall be provided to lock the valves in open position during normal operation. Underground valves shall be kept in an open position at all times.

4.4.2 Water supply for private fire hydrant

The provision of water supply for a private fire hydrant system, where required by this Code, shall comply with the following requirements:

a. Private fire hydrant at or below reduced level 125m

Private fire hydrants installed at reduced level 125m and below can receive direct supply from public water mains. If the flow and pressure from the public water mains cannot meet the fire hydrant requirements as shown in *Table 4.4A*, a storage tank of sufficient capacity with the requisite pumping facilities shall be provided. For premises with private fire hydrants receiving direct supply from public water mains and not able to comply with the flow requirements stipulated in *Table 4.4A*, the following requirements shall be complied with:

- (1) the compartment size shall not exceed 1000m²;
- (2) the nominal bore of the fire hydrant pipe and the bulk water meter shall not be less than 150mm in diameter; and
- (3) the running pressure/flow at the hydraulically most unfavourable fire hydrant of the private fire hydrant system shall comply with the

following:

- (a) running pressure $\geq 0.9 \times$ (running pressure of the nearest public fire hydrant – pressure drop across the bulk water metre); and
- (b) flow rate $\geq 0.9 \times$ water flow of the nearest public fire hydrant or \geq total flow demand (as required in [Table 4.4A](#)) of the private fire hydrant system, provided the running pressure at the most remote private fire hydrant is greater than 2 bars.

Note:

In calculating the frictional loss for the private fire hydrant system, the design flow rates shown in [Table 4.4A](#) shall be used. The pressure drop across bulk water metre shall not be more than 1 bar.

b. Private fire hydrant above reduced level 125m

- (1) Where more than one private fire hydrant is located above reduced level 125m within the same plot, storage and pumping arrangements of water supply to these specified fire hydrants shall comply with the requirements stipulated in *Cl.4.4.2c.*.
- (2) The private fire hydrant can be in the form of a dry fire hydrant, if it is not the sole fire hydrant within 50m from any breeching inlet(s) feeding firefighting systems for the building(s) within the plot of land, which include:
 - (a) automatic fire sprinkler systems, or
 - (b) dry riser systems, or
 - (c) wet riser systems.
- (3) A dry fire hydrant shall comply with all of the following requirements:
 - (a) A dry private fire hydrant shall be connected to a 150mm diameter dry pipe, which shall be connected at the other end to a four-way breeching inlet.
 - (b) This breeching inlet shall be within 18m from any fire engine accessway/fire engine access road having minimum 4m width and within 50m from any wet fire hydrant, private or public.
 - (c) The private dry pillar shall be painted in “yellow” and labelled “dry” on the fire hydrant pillar.
 - (d) A signage indicating the location of breeching inlet shall be positioned next to the dry private fire hydrant.

c. Water supply and storage requirement

Where more than one private fire hydrant is located above reduced level 125m within the same plot, storage and pumping arrangements of water supply to

these specified fire hydrants shall comply with those for wet rising mains stipulated in SS 575 and [Table 4.4A](#) Water Supply & Storage Requirements for Private Fire Hydrant.

4.4.3 Protection of fire hydrant mains in buildings

All fire hydrant mains which pass through a building shall have its full length within the building protected with fire resistance construction complying with [Cl.3.8.7b](#). of at least the same fire resistance as the element of structure, provided all of the following requirements are complied with:

- a. The fire hydrant mains shall be located in common circulation areas, such as car parking spaces and driveways, i.e. they shall not pass through private or confined spaces.
- b. No services (except sprinkler pipes) shall be located above or crossing over the fire hydrant mains.
- c. The fire hydrant mains shall be located away from explosion risk areas.
- d. The protective enclosure to the fire hydrant mains shall be labelled with the words “FIRE HYDRANT MAIN” of minimum 50mm height at suitable intervals.

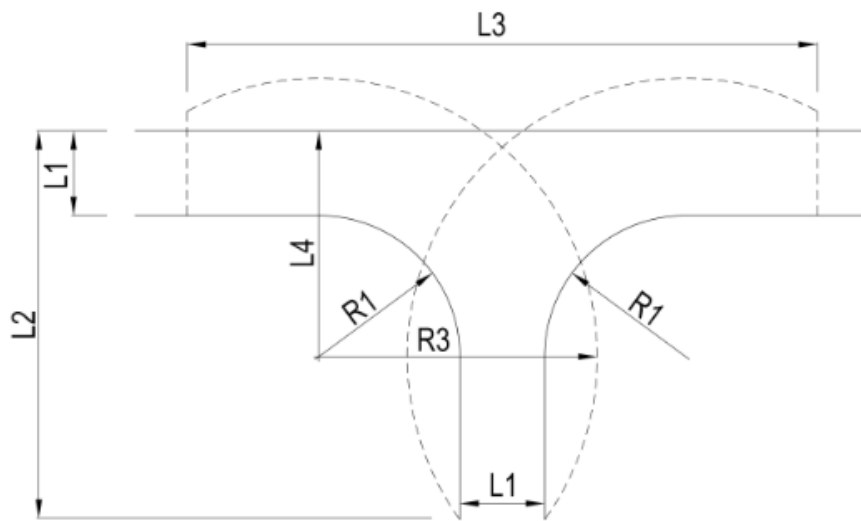

Cul-de-sac turning facility

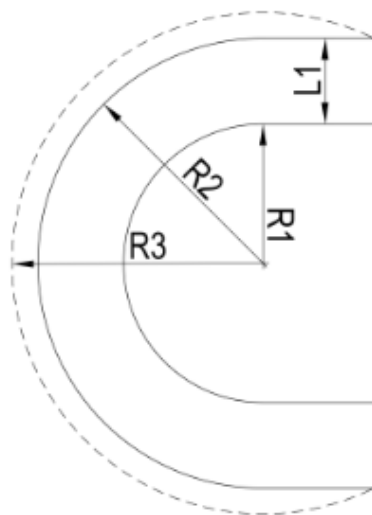

U-turn radii

Dimensions of Turning Facilities for Firefighting Appliances			
Parameters	Building Habitable Height		
	≤ 10m	> 10 & ≤ 50m	> 50m
R1	4.0m	6.5m	7.5m
R2	8.0m	10.5m	12.0m
R3	8.5m	12.0m	14.8m
L1	4.0m	4.0m	4.5m
L2	11.0m	16.0m	21.0m
L3	15.0m	28.1m	33.5m
L4	8.0m	10.5m	12.0m

Diagram 4.2.2e. : Turning facilities for firefighting appliances

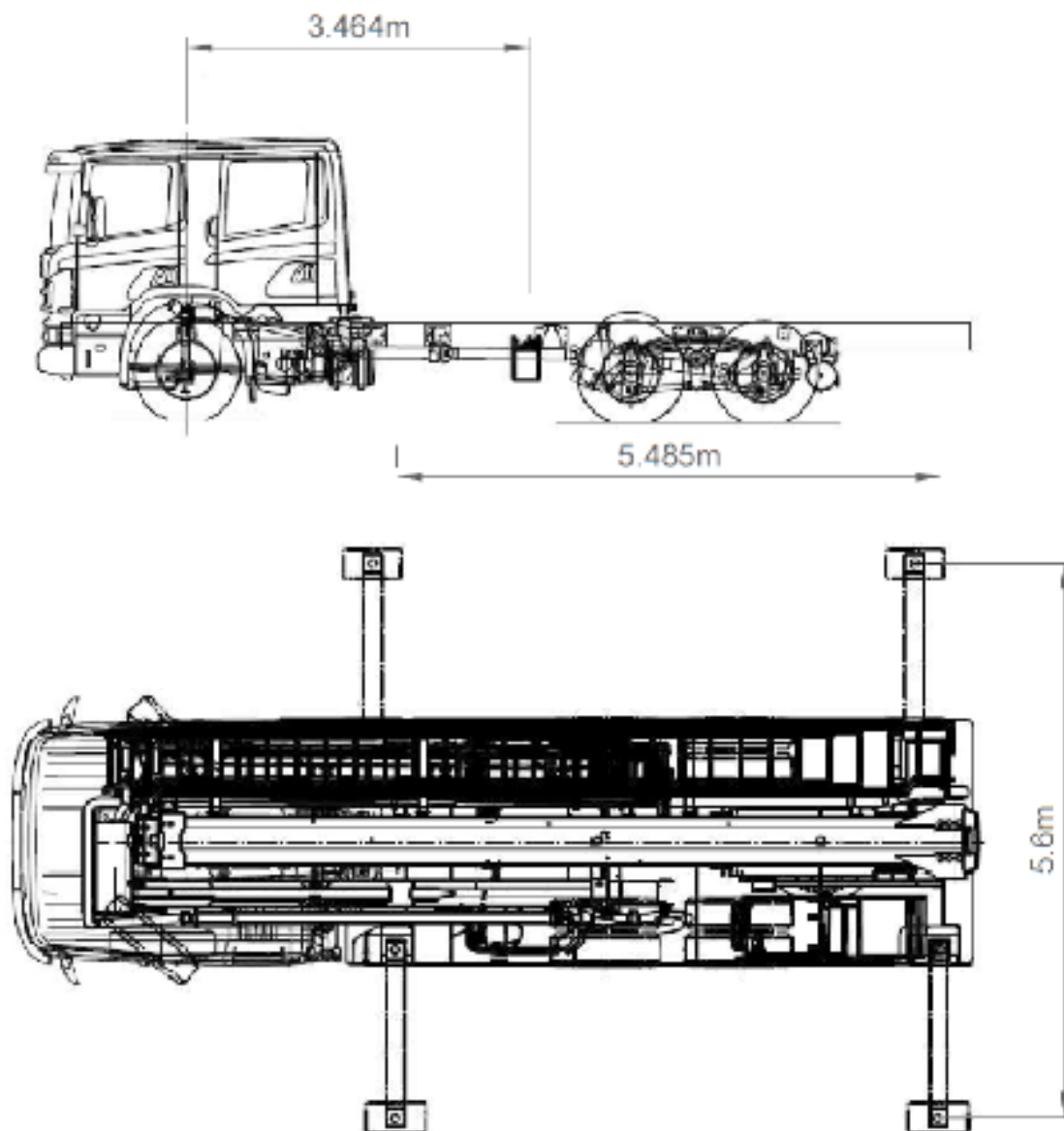

[Diagram 4.2.2j.\(1\) - 1 : CPL 34 firefighting appliance - Wheels & jacks layout](#)

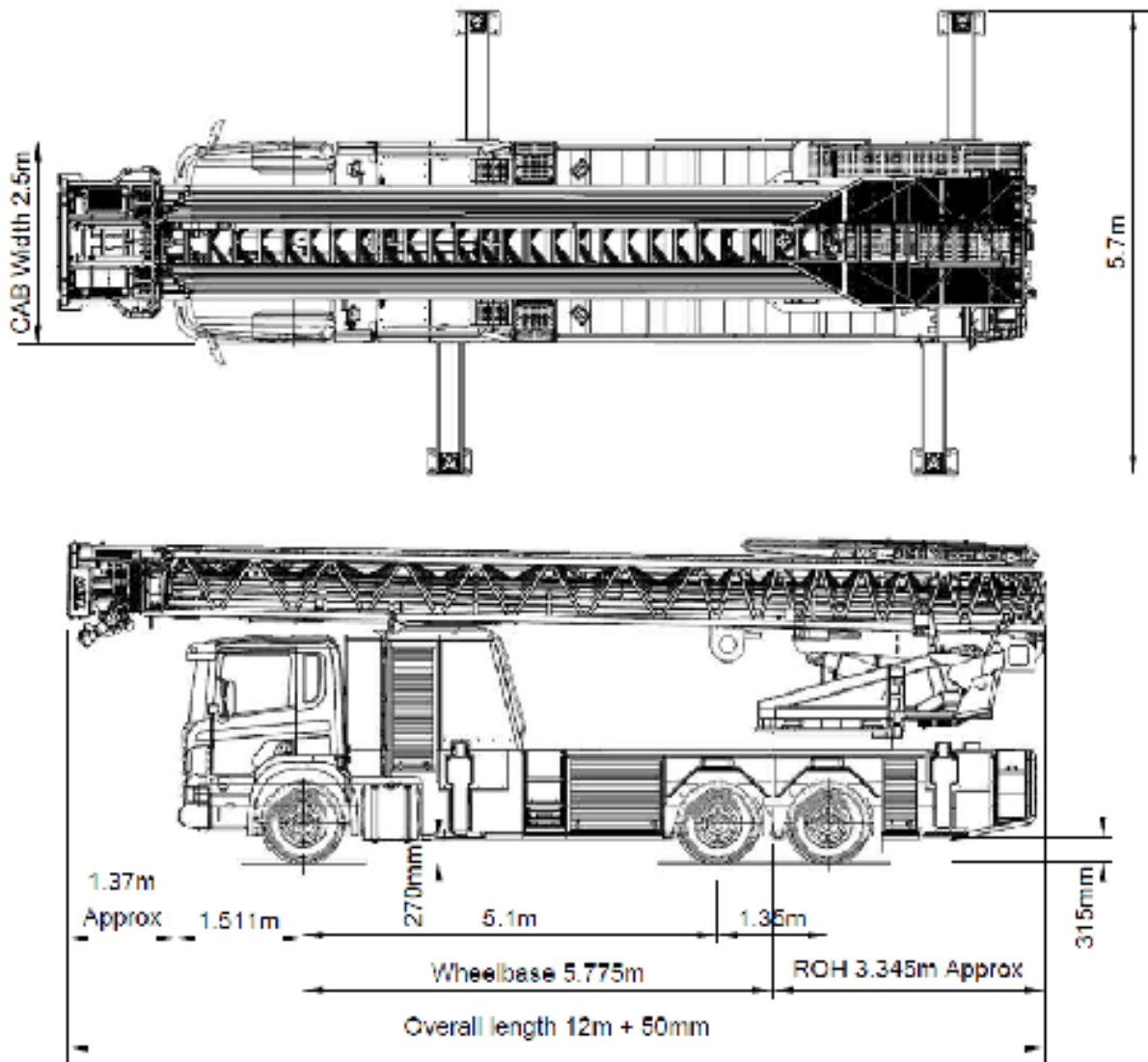

[Diagram 4.2.2j.\(1\) - 2 : AL 56 & CPL 60 firefighting appliances -
Wheels & jacks layout](#)

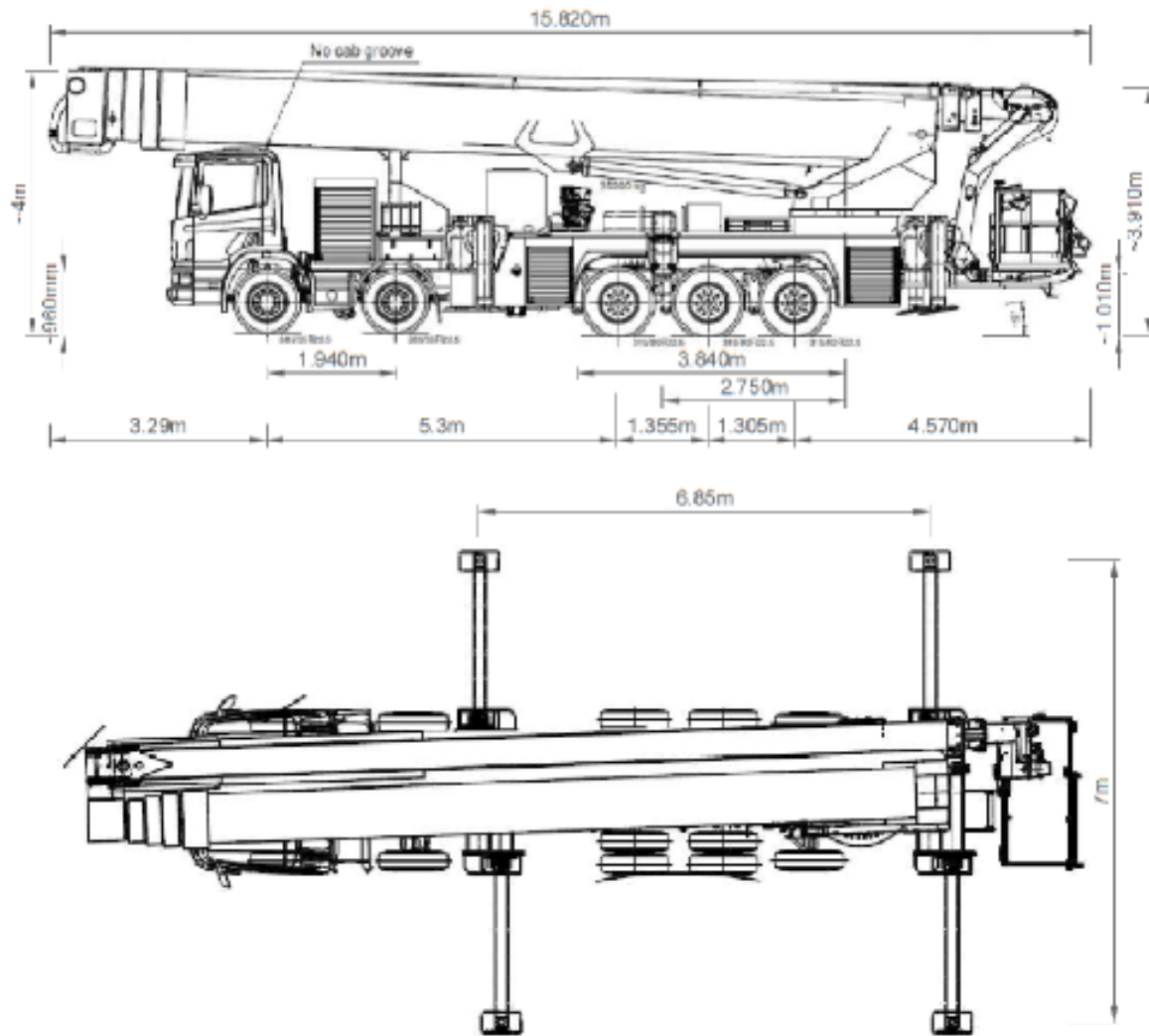

[Diagram 4.2.2j.\(1\) - 3 : HLA 90 firefighting appliance - Wheels & jacks layout](#)

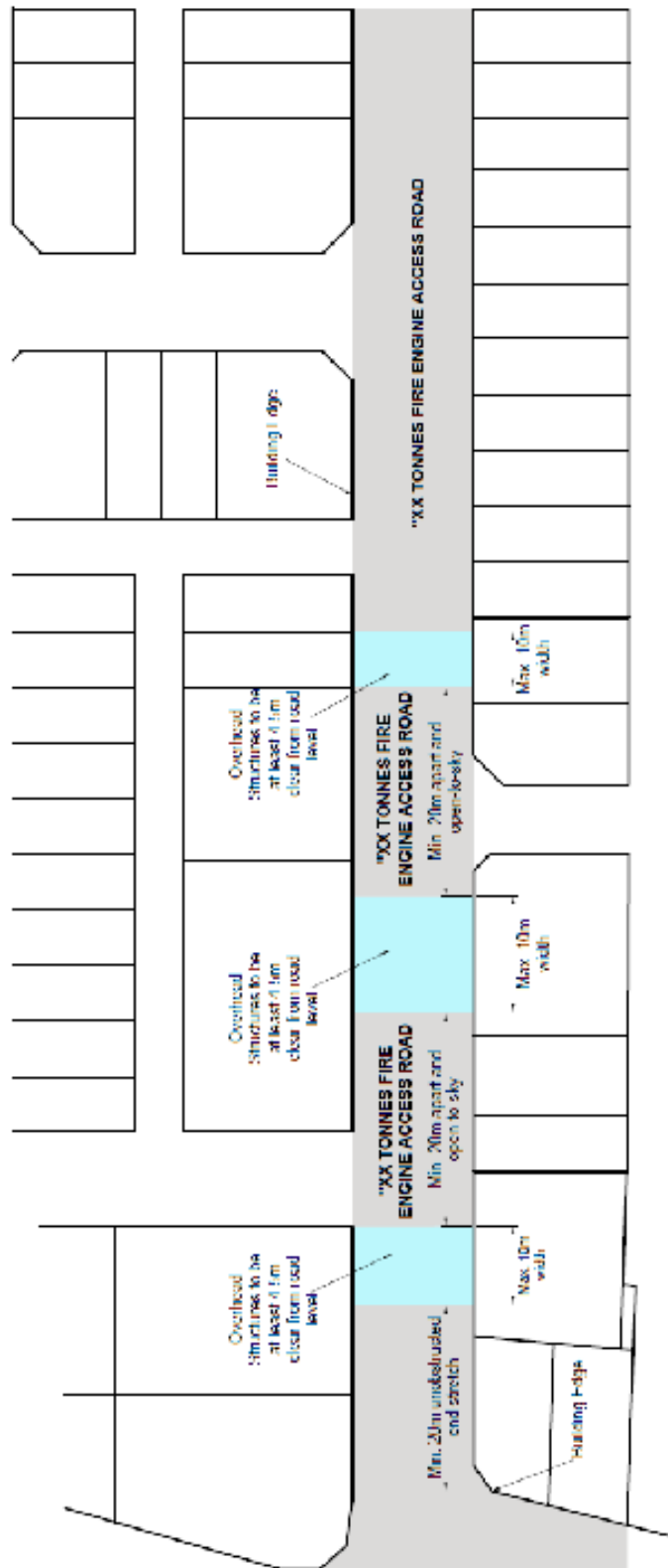
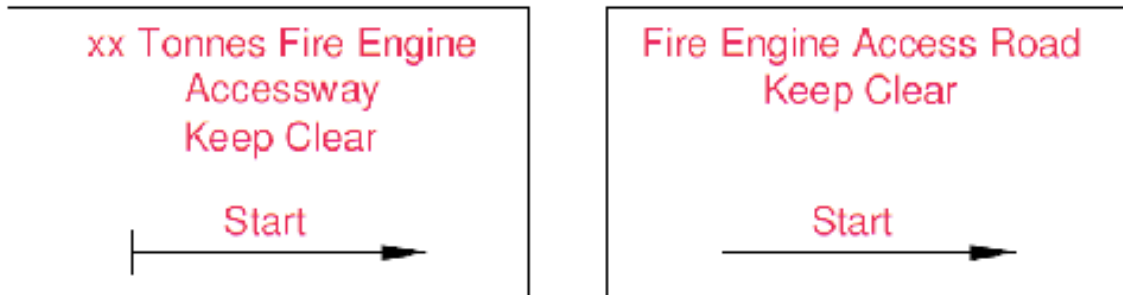

Diagram 4.2.2f. : Building structure over fire engine accessway/fire engine access road

(1) At the start of the fire engine accessway/ fire engine access road



(2) Along the fire engine accessway/ fire engine access road



(3) At the end of the fire engine accessway/ fire engine access road

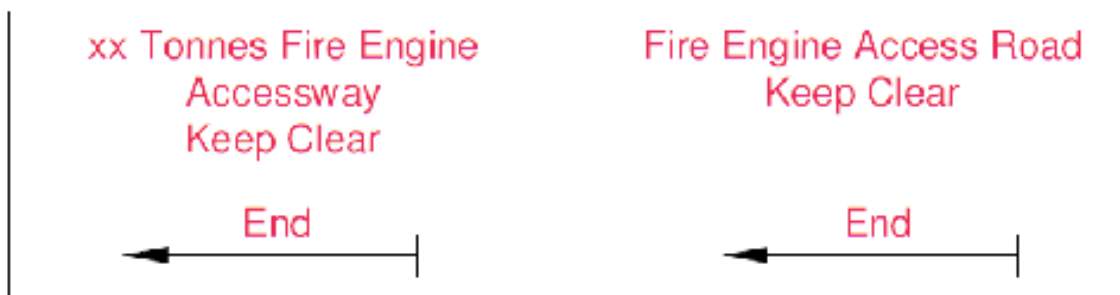

[Diagram 4.2.2i.\(3\) : Signage for fire engine accessway/fire engine access road](#)

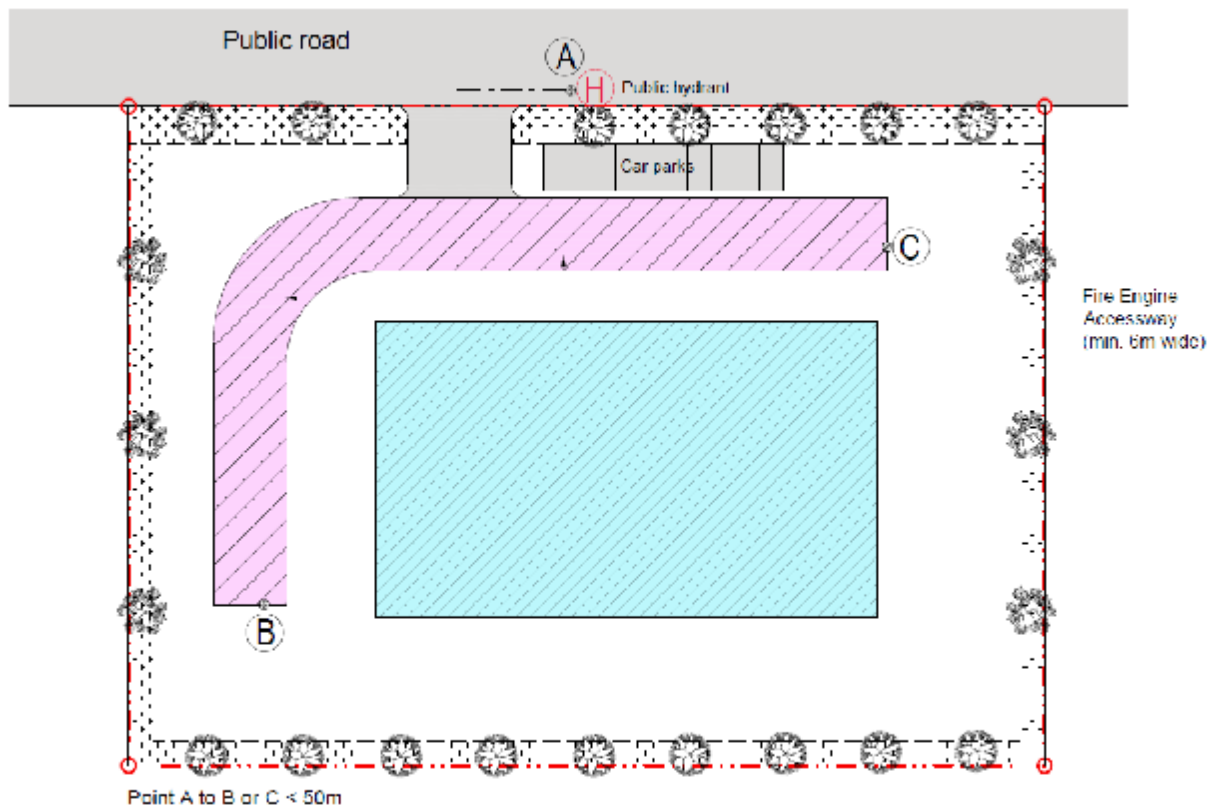

Every part of a fire engine accessway/fire engine access road in a private lot shall be within an unobstructed distance of 50m from a hydrant. Where a private hydrant conforming to such requirement is not available, private hydrant(s) shall be provided.

[Diagram 4.4.1a. : Provision of private fire hydrant](#)

Provision Of Private Hydrant

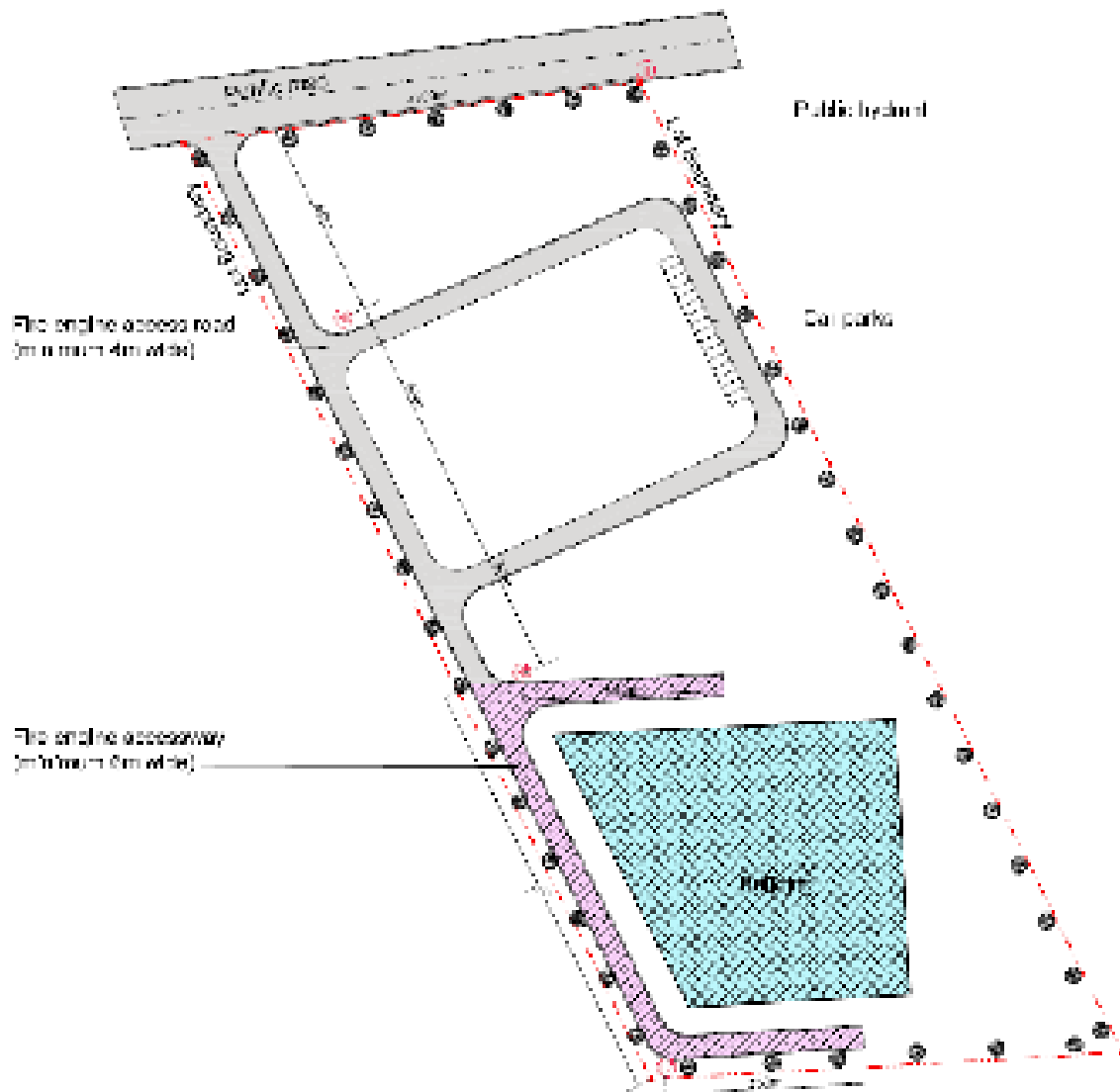

Notes:

 Private hydrant

In a situation where more than one private hydrant is required, the hydrants shall be located along the fire engine accessway/ fire engine access road such that every part of the fire engine accessway/ fire engine access road is within an unobstructed clearance of 50m from any hydrant.

[Diagram 4.4.1c. : Siting of private fire hydrant](#)

TABLE 4.2A : FIRE ENGINE ACCESSWAY/FIRE ENGINE ACCESS ROAD FOR PG II BUILDINGS		
Details	Habitable Height (m)	
	≤ 10	> 10 & ≤ 50
Width of fire engine access road	≥ 4m	
Width of fire engine accessway*	Not required	≥ 6m
Length of fire engine accessway*	-	≥ 15m
Type of firefighting appliance	Pump ladder	CPL 34 & AL 56 AL 56, CPL 60 & HLA 90
Loading capacity of fire engine access road#	≥ 24 tonnes	≥ 30 tonnes
Loading capacity of fire engine accessway#	-	≥ 30 tonnes
Axle/Jack loading	-	See Table 4.2F & Table 4.2G
Turning facility	See Diagram 4.2.2e .	
U-turn radii	See Diagram 4.2.2e .	
<p><u>Note:</u></p> <p># = The appended figures for loading capacity of fire engine accessway/fire engine access road are characteristic values.</p> <p>* = The fire engine accessway shall be provided and located to access at least one entire facade of each building block.</p>		

TABLE 4.2B : FIRE ENGINE ACCESSWAY/FIRE ENGINE ACCESS ROAD FOR PG III, IV, V & VII BUILDINGS		
Details	Habitable Height (m)	
	≤ 10	> 10 & ≤ 50
Width of fire engine access road	≥ 4m	
Width of fire engine accessway	Not required	≥ 6m
Length of fire engine accessway	-	See Table 4.2.2a.(6)
Type of firefighting appliance	Pump ladder	AL 56, CPL 60 & HLA 90
Loading capacity of fire engine access road [#]	≥ 24 tonnes	≥ 30 tonnes
Loading capacity of fire engine accessway [#]	-	≥ 30 tonnes
Axle/Jack loading	See Table 4.2D & Table 4.2E	
Turning facility	See Diagram 4.2.2e .	
U-turn radii	See Diagram 4.2.2e .	
<p><u>Note:</u></p> <p># = The appended figures for loading capacity of fire engine accessway/fire engine access road are characteristic values.</p>		

TABLE 4.2C : FIRE ENGINE ACCESSWAY/FIRE ENGINE ACCESS ROAD FOR PG VI & VIII BUILDINGS		
Details	Habitable Height (m)	
	≤ 10	> 10 & ≤ 50
Width of fire engine access road	≥ 4m	
Width of fire engine accessway	≥ 6m	≥ 7m
Length of fire engine accessway	See Table 4.2.2a.(7)	
Type of firefighting appliance	CPL 34 & AL 56	CPL 34 & AL 56 AL 56, CPL 60 & HLA 90
Loading capacity of fire engine access road [#]	≥ 30 tonnes	≥ 30 tonnes ≥ 50 tonnes
Loading capacity of fire engine accessway [#]	≥ 30 tonnes	≥ 30 tonnes ≥ 50 tonnes
Axle/Jack loading	See Table 4.2D & Table 4.2E	
Turning facility	See Diagram 4.2.2e .	
U-turn radii	See Diagram 4.2.2e .	
<u>Note :</u>	# = The appended figures for loading capacity of fire engine accessway/fire engine access road are characteristic values.	

TABLE 4.2D - AXLE LOADINGS OF FIREFIGHTING APPLIANCES										
Axle No. (from front)	Type of firefighting appliances									
	Pump Ladder		CPL 34		AL 56		CPL 60		HLA 90	
	Loading Wt. (kg)	No of wheels	Loading Wt. (kg)	No of wheels	Loading Wt. (kg)	No of wheels	Loading Wt. (kg)	No of wheels	Loading Wt. (kg)	No of wheels
Axle 1	10000	2	7500	2	9000	2	9000	2	9000	2
Axle 2	14000	2	10500	2	10500	4	9900	4	9000	2
Axle 3	---	---	10500	4	10500	4	9900	4	10500	4
Axle 4	---	---	---	---	---	---	8200	2	10500	4
Axle 5	---	---	---	---	---	---	---	---	10000	2
Axle 6	---	---	---	---	---	---	---	---	---	---

Note:
The appended figures for axle loading are characteristic values.

TABLE 4.2E - JACK LOADINGS OF FIREFIGHTING APPLIANCES			
Type of Fire Appliance	CPL 34	AL56	HLA 90
Jack load contact area	5625 cm ²	5625 cm ²	7125 cm ²
Maximum pressure per Jack (4 jacks per vehicle)	37 N/cm ²	37 N/cm ²	50 N/cm ²

Note:
The appended figures for jack loading are characteristic values.

TABLE 4.4A WATER SUPPLY & STORAGE REQUIREMENTS FOR PRIVATE FIRE HYDRANT				
Purpose Group	Accessible Floor Area* (m²)	Minimum Flow Rate (L/s)	Minimum Running Pressure (bar)	Minimum Water supply and Storage Duration (mins)
PG I & II	-	27	2	45
PG III, IV, V & VII	≤ 1000	38	2	45
	> 1000 & ≤ 5000	57		
	> 5000 & ≤ 10000	76		
	> 10000	95		
PG VI & VIII	≤ 500	38	2	90
	> 500 & ≤ 5000	57		
	> 5000 & ≤ 10000	76		
	> 10000 & ≤ 15000	95		
	> 15000 & ≤ 20000	114		
	> 20000	133		
Note :				
* = Based on the Accessible Floor Area (AFA) of the largest compartment in the building				

The background of the page is a collage of various electrical circuit diagrams. These diagrams include components like resistors, capacitors, inductors, diodes, and integrated circuits, all interconnected with lines representing electrical connections. Some diagrams also feature digital displays showing '8888'. The diagrams are rendered in a light, semi-transparent style, creating a technical and complex visual texture.

CHAPTER

05

ELECTRICAL POWER SUPPLIES

CHAPTER

5

ELECTRICAL POWER SUPPLIES

5.1 GENERAL

The installation, control and distribution of wiring of electrical equipment in buildings shall be in accordance with SS CP 5 and SS CP 551.

5.2 PRIMARY AND SECONDARY POWER SUPPLIES**5.2.1 Installations requiring primary and secondary power supplies**

Where any of the following installations is required by this Code or other Codes/Regulations, its primary and secondary source of power supply shall comply with the corresponding Code of Practice stated therein.

a. Electrical lifts

Where an electrical passenger or goods lift is required, its electrical installations, including batteries and other forms of secondary power supply, shall comply with SS 550. Where the provision of fire lift is required by this Code, installation of the primary and secondary supplies shall also comply with the above-mentioned Code of Practice.

b. Electrical fire alarm system

Where electrical fire alarm system is required, its primary power supply as well as its type and capacity of battery shall comply with SS CP 10.

c. Exit light and emergency lighting systems

Where exit or emergency lighting system is required, its electrical wiring, type and capacity of battery or other form of secondary power supply shall comply with SS 563.

d. Emergency voice communication system

Where an emergency voice communication system is required, its electrical wiring shall be fire-rated or otherwise fire-protected in accordance with SS 546. The appropriate type and capacity of secondary source of supply shall also be provided accordingly.

e. Wet rising main system

Where a wet rising main system is required, the relevant electrical supply shall be installed in accordance with SS 575. A secondary source of power supply with capacity stipulated in SS 575 shall be provided for the wet rising main pumps.

f. Fire sprinkler system

Installation of electrical supply for sprinkler systems shall comply with SS CP 52. The capacity of the secondary source of supply, where required, shall satisfy operational requirements under the respective hazard category.

g. Mechanical ventilation/pressurisation systems

The following systems shall be provided with secondary source of power supply:

- (1) mechanical ventilation system for the following rooms or spaces:
 - (a) exit staircases;
 - (b) exit passageways;
 - (c) smoke-stop/fire lift lobbies;
 - (d) area of refuge within the same building;
 - (e) basement car parks;
 - (f) fire command centres;
 - (g) emergency power generator rooms;
 - (h) engine driven fire pump rooms;
 - (i) rooms involving the use and/or storage of flammable liquid/gas and explosive substances;
 - (j) any other areas where such systems are installed for fire precautionary measures; and
- (2) pressurisation systems for the following areas:
 - (a) smoke-stop/fire lift lobbies;
 - (b) internal exit staircases;
 - (c) hotel corridors;
 - (d) hostel corridors;
 - (e) healthcare corridors; and
 - (f) any other areas where such systems are installed.
- (3) all smoke control/purging systems, including associated equipment forming part of the systems.

h. Air supply system for generator and fire pump

A secondary source of power supply shall be provided for the mechanical ventilation system which is installed to provide air for the operation of the following equipment:

- (1) emergency generator; and
- (2) engine driven fire pump.

5.2.2 Cable installation

Power supply cables for equipment that are required to operate during a fire emergency shall be of fire resistant type. The fire resistant cables shall comply with SS 299.

5.2.3 Electric motors and control equipment

All motors and their control equipment, as well as the associated wiring and accessories, shall be suitable for their particular application and for the environment they are exposed to. In addition, they shall comply with all of the following requirements:

- a. High Rupturing Capacity Fuses (HRC) or Moulded Case Circuit Breakers (MCCB) with magnetic release shall be installed and be capable of protecting the cable connections to the motor, and of carrying the stalled current of the motor for a period not less than 75% of the period for which such a current would cause the motor windings to fail;
- b. any no-volt release mechanism shall be of the automatic resetting type, such that on restoration of supply the motor can start automatically;
- c. thermal overload trips shall not be permitted; and
- d. magnetic (short circuit) trips are permitted for use in motor circuits of mechanical ventilation systems serving essential services.

5.2.4 Emergency generator

- a. Where emergency generators are provided as a secondary source of supply, they shall comply with SS 535.
- b. For outdoor emergency generator, all of the following requirements shall be complied with:
 - (1) Day tank incorporated within the body of the emergency generator shall be constructed of steel. The day tank shall be of double skin construction. The emergency generator enclosure shall be able to contain any leakage of diesel.
 - (2) Alternatively, an internal bund wall shall be built within the outdoor emergency generator's day tank large enough to contain 100% of the diesel content within the day tank.
 - (3) The maximum quantity of diesel permitted in the day tank is 1000 litres.

The background of the page is a collage of various architectural and technical drawings related to fire systems. It includes floor plans with room layouts, detailed views of fire extinguishers, fire alarm pull stations, and other fire safety equipment. The drawings are rendered in a light, semi-transparent style, creating a layered and technical aesthetic.

CHAPTER

06

FIREFIGHTING SYSTEMS

CHAPTER**6****FIREFIGHTING SYSTEMS****6.1 PORTABLE EXTINGUISHERS****6.1.1 General**

- a. Portable fire extinguishers, where required, shall be constructed in accordance with SS EN 3.
- b. All portable fire extinguishers, where required to be provided, shall be charged, tested, maintained and properly tagged in accordance with SS 578.

6.1.2 Provision

- a. Fire extinguishers shall be provided in all buildings except the following:
 - (1) PG I buildings;
 - (2) residential floors of PG II buildings; and
 - (3) car parking areas in standalone car parks or mixed-use residential buildings.
- b. Where the roof level is a non-habitable floor, fire extinguishers shall be provided to cover the M&E plants/equipment.

6.1.3 Type, size and siting

The classification of portable fire extinguishers provided shall be selected in accordance with SS 578 such that the nature of processes and contents within the building concerned can be effectively protected. The size, quantity and siting of these portable fire extinguishers shall comply with the requirements in SS 578 under the respective class of occupancy hazard.

6.1.4 Installation and marking

Portable fire extinguishers provided shall be installed and conspicuously marked in accordance with requirements by SS 578.

6.2 RISING MAIN AND HOSE REEL SYSTEMS**6.2.1 Type of rising mains**

- a. The type of rising main system provided shall be appropriate to the building as follows:
 - (1) dry rising mains shall be installed in PG II to VIII buildings of habitable

height more than 10m, but not more than 60m;

- (2) wet rising mains shall be installed in buildings with habitable height exceeding 60m; and
 - (3) separate dry and wet rising main systems in a building are permitted.
- b. Notwithstanding the requirements in *Cl.6.2.1a.*, dry rising mains conforming to SS 575 shall be provided to supply any part of a single or multiple level basement.
 - c. Where the building has access from more than one ground level or road level, the height measurements for the purpose of this Code shall be taken from the level of the fire engine accessway. Where there is no fire engine accessway, the height measurements shall be based on fire engine access road.

6.2.2 Number, location and size of rising mains

a. **Standard**

The number, distribution, size and installation of rising mains shall comply with the requirements stipulated in SS 575.

b. **Locations of landing valves**

Rising mains and the associated landing valves shall be kept free of physical and visual obstruction, and be located:

- (1) within a fire lift lobby, smoke-stop lobby or external corridor immediately outside the door of the exit staircase, or
- (2) in the case where there is no fire lift lobby, smoke-stop lobby and external corridor, it shall be located inside an exit staircase, or in the common area and within a protected shaft, immediately outside the door of the exit staircase.

Note: Where there are provisions of fire lift lobby and smoke-stop lobby within the building, the position of rising mains and landing valves shall first be located inside fire lift lobby.

c. **Provision for landing valves and standby fire hoses**

- (1) The location and provision for landing valves shall comply with SS 575. Where any part of the 1st storey of a building, except for PG II buildings, is more than 38m (30m hose line length and a jet throw of 8m) from the breeching inlet, a landing valve at the 1st storey shall be provided.
- (2) Where all the exit staircases in a building under PG III to VIII are installed with rising mains and standby fire hoses, and yet part of a floor space is beyond the 38m (30m hose line length and a jet throw of 8m) coverage of any landing valve, an additional standby fire hose shall be provided at the landing valve nearest to this floor space.

6.2.3 Breeching inlets and fire engine accessway/fire engine access road

- a. All buildings fitted with rising mains shall have a fire engine accessway/fire engine access road for firefighting appliances within 18m of the breeching inlet. The breeching inlets shall be visible from the fire engine accessway/fire engine access road.
- b. The requirements and provisions for breeching inlets for the rising main system shall be in accordance with the SS 575. Connecting pipes between the inlets and the vertical run of the rising mains, where applicable, shall be kept as short as possible.

6.2.4 Wet rising mains

a. Water supply

The capacity of the water supply from the public mains and the storage capacity for a wet rising main system shall comply with the requirements in SS 575.

b. Flow

The flow requirements for wet rising main system shall comply with those stipulated in SS 575.

c. Running pressure

Running pressure at each discharging landing valve on the wet rising main system shall be maintained between the minimum and maximum values as stipulated in SS 575.

d. Static pressure

Static pressure in any line of hose connected to a landing valve in a wet rising main system shall not exceed the specified value in SS 575.

e. Storage tanks

The location of storage tank and capacity of break tank where required shall comply with the requirements in SS 575.

f. Fire pumps

Installation of fire pumps for wet rising main system shall comply with the requirements of SS 575. Wet riser pumps shall be installed within a fire compartmented fire pump room, whose fire rating shall be in accordance with [Table 6.4A](#). The fire pump room floor level shall not be lower than the main floor level.

g. Water supply system

- (1) The water supply requirements for wet riser system shall be as follows:

TABLE 6.2.4g - WATER SUPPLY FOR WET RISER SYSTEM		
No: of stacks	Water flow rate (L/s)	
	Non-residential buildings	Residential buildings
1	38	27
2	57	40.5
3	76	54
4 & above	95	67.5

- (2) The minimum water storage capacity shall be capable of supplying water at the above flow rate for the period as specified in SS 575.

6.2.5 Standby fire hose for rising mains

Standby fire hoses shall be provided for every rising main except for those in buildings under PG II. The following requirements shall be complied with:

a. Type and folding method

- (1) The standby fire hose shall be of 63.5mm nominal internal diameter in order to ensure that the hose coupling will fit the existing coupling tail pieces. The hose shall be rugged and capable of carrying water under substantive pressure in accordance with BS 6391. The fire hose shall be of Type 3 as stipulated in BS 6391.
- (2) The fire hose couplings shall be manufactured to BS specifications or equivalent and of be light alloy or gunmetal. The coupling shall be of 63.5mm diameter and be of the instantaneous type with standard (double-pull) release mechanism. The couplings shall be secured to the hoses with galvanised mild steel wire and applied over a hose guard of synthetic fibre. It shall be able to withstand a minimum working pressure of 15 bars.
- (3) Each hose shall have a standard length of 30m and shall be kept stowed in a Dutch Roll and housed in a glass fronted cabinet. The Dutch Roll shall be rolled in the manner shown in *Diagram 6.2.5a.(3)*.

b. Position

- (1) The fire hose shall be installed just next to, but not more than 2m from the landing valve as shown in *Diagram 6.2.5b.(1)*.
- (2) The entire fire hose and cabinet shall be installed away from direct sunlight.

c. Mounting

The wall mounted fire hose and cabinet shall be as follows:

- (1) The cabinet shall be firmly mounted on the wall and able to withstand the weight of the hose(s) it houses.

- (2) The cabinet shall be constructed of non-combustible material and be maintenance free.
- (3) The cabinet lock, if provided, shall be one that can be operated manually from the inside without the use of a key when the front tempered glass (minimum 300mm x 300mm) is broken by firefighters.
- (4) The cabinet swing door shall be made openable such that it will not obstruct the retrieving of the fire hose by firefighters.
- (5) The depth of the cabinet shall not exceed 250mm for one fire hose or 350mm for two fire hoses.
- (6) The cabinet shall be painted in a contrasting colour such that it is conspicuous and easily identified.
- (7) The wording, "FIRE HOSE", with letter height of at least 50mm and shown in contrasting colour, shall be painted directly on the front panel as shown in *Diagram 6.2.5b.(1)*.
- (8) In lieu of the cabinet, a simple wall mounted cradle for the fire hose can be provided, but only in the riser main shaft. The cradle shall be constructed and positioned to facilitate the retrieving of fire hose by firefighters.
- (9) The cradle (in lieu of the cabinet) shall be maintenance-free. The fire hose installation height shall be limited as indicated in *Diagram 6.2.5b.(1)*.

d. General

- (1) Only clean, dry and compactly rolled (Dutch Roll with the Velcro strap secured as shown in the *Diagram 6.2.5a.(3)* and *b.(1)*) hose(s) shall be placed in the cabinet.
- (2) BS 6391 stipulates the technical requirements for quality acceptance standards of the fire hose. In addition, the abovementioned requirements shall be applicable for acceptance of the standby fire hose.

6.2.6 Building under construction

When a building in pursuance of *Cl.6.2.1*, is required to be equipped with rising mains, such rising mains shall be installed progressively as the building attains height during the course of construction. All outlets, landing valves and inlets, water tanks and pumps, and hydrants shall be properly installed so as to be readily operational in case of fire.

6.2.7 Foam inlets

a. Provision

- (1) Where boiler room or storage room containing highly combustible materials are located in a basement, or is not easily accessible for fire-fighting, foam inlets and pipe works shall be provided for the purpose of delivering foam solution to an area close to the room concerned.

- (2) In situations where such rooms have access openings along a fire engine accessway, provision of foam solution inlets and outlets is not required.

b. Breeching inlet

A two-way breeching inlet shall be provided at ground level with pipe run of minimum 100mm bore, terminating with a landing valve just outside the high fire risk room. The provision of the breeching inlet shall comply with the relevant clauses of SS 575.

6.2.8 Hose reels

a. Provision

- (1) Hydraulic hose reel(s) conforming to the requirements in SS 575 shall be provided to every storey of every building regardless of building height.
- (2) Where a roof level is a non-habitable floor, fire hose reels shall be provided to cover the M&E plants/equipment.
- (3) Exemption
 - (a) PG I buildings.
 - (b) Non-residential occupancy at the 1st storey of a mixed commercial-cum-residential building or single storey standalone building and fulfilling all of the following conditions:
 - (i) AFA of the non-residential unit does not exceed 150m².
 - (ii) Individually compartmented except for the parts of the unit fronting and within 3m from the external.
 - (iii) Not being used as an eating establishment, or for storage of flammable materials.
 - (iv) Not being used as a public entertainment outlet.
 - (v) Not belonging to PG VI or VIII buildings.
 - (vi) Not being used as a dormitory, hostel, etc. where sleeping risk is involved.
 - (c) Other standalone buildings as follows:
 - (i) Single-storey guard houses.
 - (ii) Bin centres.
 - (iii) 22kV (and lower) electrical substations.
 - (iv) Open-sided sheds (excluding those for PG VI and VIII usages with floor areas not exceeding 200m²) and openings that constitute not less than 80% of the perimeter wall area (measured along the roof eaves).

- (d) Mezzanine floor of factory unit, subject to compliance with *Cl.9.6.1a.(2)*, and provided the coverage distance of the nearest hose reel at the main floor to the most remote point of the mezzanine floor does not exceed 36m (30m hose path and 6m throw).

b. Size and type

The hose shall be of 20mm or 25mm nominal diameter and conform to EN 694, shall not exceed 30m in length and terminate in “shut-off” branches with 4mm or 6mm nozzles.

c. Water supply

Water supply for hose reels in terms of flow rate and minimum running pressure shall comply with the requirements in SS 575.

d. Siting and installation

- (1) Siting and details of installation for hose reels shall comply with the requirements in SS 575.
- (2) Installation for hose reels shall comply with the requirements in SS 575.
- (3) Hose reels shall be sited in prominent and accessible locations within a distance of 5m from the exit door but not inside exit staircases. If there are parts of the floor space that are beyond the 36m coverage (30m hose path and 6m throw) of the hose reel, additional hose reels shall be provided at the common area or at a distance of not more than 5m from the exit access door of a room.
- (4) Hose reels located within a room shall not be used for covering the areas outside the room.

e. Piping

The use of copper or stainless steel piping is permissible for the connection of the hose reels to the PUB mains.

6.2.9 Graphical symbols

Graphical symbols to depict fire safety equipment are allowed for use in buildings provided the signs comply with SS 508. The Table below shows the different sizes of the graphical symbol with respect to the viewing distance.

TABLE 6.2.9 : SIZES OF GRAPHICAL SYMBOLS				
Viewing Distance	0 to 6m	> 6 to 9m	> 9 to 12m	12m or more
Minimum height of symbol (Z=100)	60mm	90mm	120mm	150mm
<p><u>Note :</u></p> <p>The luminous factor (Z=100) from SS 563 is used to determine the size of the sign. It essentially dictates the size of the sign that varies with distance. The graphical symbol for firefighting equipment shall be sized such that the height and width are same. The size of symbol is not inclusive of borders.</p>				

6.3 ELECTRICAL FIRE ALARM SYSTEM

6.3.1 General

a. PG III to VIII occupancies

- (1) Every building or part of a building, except that of PG I or II (residential floors), having a total floor area of more than that specified in column (3) of [Table 6.3A](#) having regard to the purpose group of the building or part of the building, shall be installed with a fire alarm system, either of the automatic or manual type as indicated in column (4), which shall be an electrically supervised system complying with the requirements of the SS CP 10. The fire alarm system shall be connected to the SCDF's Operations Centre through an approved alarm monitoring company if required under [Cl.6.3.8](#).
- (2) Notwithstanding [Cl.6.3.1a.\(1\)](#) above, if the total floor area per storey of a 2 to 4 storey building of any of the PG III to VIII exceeds the sizes as stipulated in column (2) of [Table 3.2A](#), the building shall be provided with an automatic fire alarm system.

b. PG II mixed occupancy

For PG II mixed occupancy buildings where an automatic sprinkler system and/or electrical fire alarm system is provided to the non-residential part of the building:

- (1) Alarm sounders shall be installed within the non-residential units, at the common areas of the non-residential floors and extended to the immediate two residential floors above the non-residential floor.
- (2) The alarm sounders shall be able to produce a minimum sound level of 65dBA, or 5dBA above the ambient noise level in all parts of such areas.
- (3) Connection of the fire alarm system to an approved alarm monitoring company stipulated under [Cl.6.3.8](#) is not required if the number of non-residential floors is not more than one storey.

c. Dormitories

For dormitories, including workers' dormitories, an electrical fire alarm system shall be provided as follows:

- (1) For single storey dormitory buildings, manual fire alarm system is to be provided to comply with SS CP 10.
- (2) For dormitories exceeding more than one storey, both automatic and manual fire alarm systems shall be provided to comply with SS CP 10.

6.3.2 Fire alarm panel

- a. An electrical fire alarm system of the automatic or manual type shall be provided with a fire alarm panel to indicate the location of the alarm which

has been actuated or operated. Such an alarm panel shall be accurate to the maximum allowed alarm group area limitations specified in SS CP 10.

- b. The associated control and supervisory equipment, indicating equipment, wiring and arrangement of power supplies for the fire alarm panel shall comply with the requirements in SS CP 10.
- c. All automatic systems which are activated via the general building alarm shall be connected directly to the fire alarm panel.
- d. The fire alarm panel shall be located near the main entrance of the building, in the Fire Command Centre (FCC), in the guardhouse or in the fire lift lobby.
- e. Sub fire alarm panel, where provided, shall comply with the requirements in SS CP 10 be located at the fire lift lobby, smoke-stop lobby, or protected staircase, in that order of priority, or at the main point of entry into the area covered by the alarm zone.

6.3.3 Manual alarm call points

- a. In a manual alarm system, except as otherwise exempted in *Cl.6.3.1*, the manual call points shall be provided on every storey of the building or part of the building and shall be so located that no person need travel more than 30m from any position within the building to activate the alarm.
- b. Manual call points shall be located on exit routes preferably next to hose reels and in particular on the floor landings of exit staircases and at exits to the street. In the case where an automatic fire alarm system is provided, grouping for indication of location of the manual call points shall comply with the requirements in SS CP 10.
- c. Manual call points shall be located between 800mm and 1.2m above the finished floor level and shall be located at easily accessible and conspicuous positions free from obstructions. The installation of the sounding device shall be in accordance with SS CP 10.

d. Exemption

Manual call points can be omitted for the following:

- (1) car parks, regardless whether the parking facility is standalone type or forms part of a building;
- (2) open-to-sky roof gardens/terraces, provided an alarm sounder is extended to this level and positioned near the exit staircase except for developments where fire alarm system is not required; and
- (3) mezzanine floor of factory unit, subject to compliance with *Cl.9.6.1a.(2)* and provided no person on the mezzanine floor need to travel more than 30m to activate the nearest manual call point located on the main floor.

- e. Manual call point shall be provided for buildings protected with an automatic fire sprinkler system or automatic fire alarm system.

6.3.4 Automatic fire alarm

Where an automatic fire alarm system is required by this Code, the type, location, spacing and installation of the detectors shall comply with the requirements in SS CP 10.

6.3.5 Alarm device

a. General

- (1) The alarm device, which should normally issue an audible or visible signal, unless specifically allowed or required otherwise by the SCDF, shall be actuated if the electrical fire alarm system is activated or operated. The type, number and location of the alarm device shall comply with the requirements in SS CP 10.
- (2) All sounders and visual alarm signals in the building shall be actuated simultaneously in the event of an activation. However, in cases permitted or required by the SCDF where the operation of alarm sounders are grouped or activated in stages, the arrangement shall comply with the requirements in SS CP 10.

b. Audio alarm

The fire alarm sounder shall have a sound that is readily distinguishable from any other alarm system.

c. Visual alarms

(1) **Provision**

- (a) Visual alarms shall be provided for buildings protected by fire alarm systems, and shall not be used in place of audible alarms.
- (b) Visual alarms shall also be provided in places where persons can be isolated. This is to account for persons with severe hearing impairment, especially when they are not in their identified locations. Such isolated spaces includes full-height enclosed washroom spaces, car park floors, lift lobbies, etc..
- (c) In dance clubs, gaming centres, places of entertainment or areas where sound and/or special effects lighting systems are installed, they shall be electronically synchronised with the fire alarm system to enable these systems to be automatically cut-off when the fire alarm system is activated.

(2) **Siting of visual alarms**

Visual alarms shall be located together with manual alarm call points. Where they are not readily visible from all accessible locations, additional visual alarms shall be provided. The height of the visual alarms shall be between 2m to 2.5m above finished floor level.

(3) **Technical specifications**

Visual alarms shall comply with all of the following requirements:

- (a) They shall take the form of a flashing beacon or strobe light for use in conjunction with the conventional fire alarm system.
- (b) They shall be clearly distinguishable from any other visual indicator used in the premises.
- (c) They shall be labelled with the word “Fire” of at least 15mm in height and lettering colour shall contrast with the background.
- (d) The flashing rate shall be within 30 to 130 flashes per minute.
- (e) The visual alarm signal shall be in white or red.
- (f) The flashing of all visual alarm signals within a same space/room shall be synchronised.
- (g) The intensity of the light signal shall be sufficient to draw the attention of people in the vicinity.

6.3.6 Home Fire Alarm Device (HFAD)

For individual residential units under PG I or II, HFAD shall be installed in accordance with all of the following requirements:

- a. HFAD shall possess the following features and comply with all the requirements stated below:
 - (1) operate on smoke detection technology alone, or have a multi-sensor detector (a detector with multiple sensors built into the device) with smoke detection capability;
 - (2) indicator lights to inform users on the status/condition of the device(s);
 - (3) temporary silence/reset feature to address false alarms;
 - (4) alarm sounder with sound level compliant with any standard listed in item (7);
 - (5) test button to allow the device(s) to be tested/checked periodically;
 - (6) to be powered by long-life built-in battery (i.e. battery that lasts at least 10 years) with low battery alert capability, or to be wired to household electrical supply;
 - (7) detector design to comply with any of the following standards (EN 14604, AS 3786, UL 217);
 - (8) where two or more HFADs are installed, all devices shall be interconnected (either wired or wirelessly) such that when one of the HFADs is triggered, all connected HFADs shall sound an alarm if they are installed on 2 or more storeys (see *Diagram 6.3.6a.(8)*); and
 - (9) the HFAD shall be either:

- (a) listed by any accredited certification body accepted by the SCDF, or
 - (b) listed by Underwriters Laboratories (UL), or
 - (c) listed under the ActivFire Scheme, or
 - (d) CE marked with certification from approved 3rd party Notified Bodies, or
 - (e) listed under BSI Product Directory.
- b. Additional independent functions to enhance the operation of the HFAD may be included as optional features (Such as connection to smart home systems, remote controls, visual alarms, vibrating pads, etc.) of the HFAD, given that the requirements indicated in *Cl.6.3.6a.* are met.
- c. *Table 6.3.6* states the minimum number of HFAD required for different home types, as well as the locations in which the detectors shall be installed.

TABLE 6.3.6 MINIMUM NUMBER OF HFAD TO BE INSTALLED FOR DIFFERENT HOME TYPES	
Home type	Number and location of detectors (Also refer to <i>Diagram 6.3.6 c. - 1 & 2</i>)
Single storey homes: (1) HDB flats (2) Apartments/Condominium (3) Single storey landed dwellings	(1) Minimum 1 smoke detector (2) Installed along circulation area / escape route, e.g. living room, corridor (3) Optional: Additional detectors can be installed in other spaces for enhanced protection.
Multi-storey homes: (1) Landed/Non-landed dwellings (2) HDB flats (3) Apartments/Condominiums	(1) Minimum 1 smoke detector per storey (2) For storeys with circulation area > 70m ² , at least 2 smoke detectors need to be installed on that storey. (3) Installed along circulation area / escape route e.g. living room, corridor, and/or staircase landing (4) Optional: Additional detectors can be installed in other spaces for enhanced protection.

6.3.7 Alarm system for cinema

A theatre or cinema shall be provided with an electrical fire alarm system of the manual type complying with all of the following:

- a. The manual alarm system shall be installed in the lobbies and other areas adjoining the hall and shall be connected to the SCDF Operations Centre through an approved alarm monitoring company.
- b. Visual indicators and audible sounders shall be installed in the projection room and in another room where a designated staff member can alert the audience in

case of a fire.

- c. The provision of the fire protection system in cinema which forms part of a building shall be similar to that of the building.

6.3.8 Connection to the SCDF Operations Centre

The electrical fire alarm system required to be installed in a building or premises under this clause shall be connected to the SCDF Operations Centre through an approved alarm monitoring company when the building or premises is:

- a. a health care occupancy, hotel or other similar occupancies, or
- b. an oil refinery, oil depot, general warehouse, chemical plant or other high hazard factory or premises, or
- c. a theatre, cinema or concert hall as specified in *Cl.6.3.7*, or
- d. a building required under the provisions of this Code to be protected by an automatic fire alarm (except those exempted under *Cl.6.3.1b.*) or fire extinguishing system.

6.3.9 Sprinkler-protected building

Where sprinkler system is required by this Code, provision of automatic thermal/smoke detectors in sprinkler-protected premises will be exempted except where such detectors are required to activate or operate the sprinkler or other systems.

6.3.10 Exemption of automatic fire alarm protection

The following areas are exempted from automatic fire alarm protection in an automatic fire alarm building:

- a. areas which are covered with trellises, louvres or perforated panels having 50% or more evenly distributed effective free openings; and
- b. external open-sided linkways not exceeding 5m in width measured from eave to eave, provided these areas are not for commercial activities or storage.

6.3.11 Video Image Fire Detection System (VIFDS)

- a. VIFDS shall be installed in addition to the electrical fire alarm system for buildings which meet all of the following conditions:
 - (1) It is an unmanned buildings belonging to PG III to VIII.
 - (2) It has an internal open space of more than 2000m² or a ceiling height of more than 12m.
 - (3) It requires the provision of automatic fire alarm system in accordance with *Table 6.3A*.
- b. VIFDS shall comply with SS CP 10 and can be used to complement smoke,

heat and flame detectors in an electrical fire alarm system.

- c. It shall be connected to the SCDF Operations Centre through an approved alarm monitoring company. Alarm signals and live video images of fire and/or smoke captured shall be transmitted to the approved alarm monitoring company upon activation of the building fire alarm system.

6.4 FIRE SPRINKLER INSTALLATION

6.4.1 Provision

The following shall be provided with an automatic sprinkler system:

a. **Compartment size**

Whenever compartmentation requirements under Chapter 3 of this Code cannot be complied with.

b. **Buildings other than PG I and II**

Every storey of buildings of more than 24m in habitable height, except for PG I and II, regardless of whether the compartmentation requirements are complied with.

c. **PG II mixed occupancy**

- (1) For PG II mixed occupancy buildings exceeding 24m in habitable height, the non-residential parts shall be protected by an automatic sprinkler system if they:

- (a) comprise more than one storey, or
- (b) are located above the first storey.

- (2) For PG II mixed occupancy buildings regardless of habitable height, the non-residential parts shall be protected by an automatic sprinkler system if they are not compartmented from the basement storeys.

- (3) For non-residential parts where sprinkler protection is not required under sub-clauses (1) & (2) above, an automatic fire alarm system shall be provided for the non-residential parts in accordance with *Cl.6.3.Ib.*

d. **Basement**

- (1) All basement storeys irrespective of compartment size, except for those used as PG I or II, shall be provided with an automatic sprinkler system. Where the upper storeys of the building are fully compartmented from the basement storeys, the requirement for provision of an automatic sprinkler system for floors above the basement shall be considered separately and in accordance with *Cl.6.4.Ia., b. and c.*

(2) Exemption

- (a) Where the basement storey is effectively cross ventilated to prevent smoke logging, the basement storey can be exempted from providing an automatic sprinkler system.
- (b) In the case of residential developments located over basement car parks, relaxation on the provision of these sprinkler system and smoke purging systems to the basement car park can be granted if all of the following conditions are met:
- (i) The basement car parking shall consist of one level only.
 - (ii) External openings shall be provided to achieve effective cross ventilation by means of evenly distributed vertical openings along the perimeter walls and evenly distributed voids over the basement in such manner that:
 - no point within the basement is more than 12m from any vertical opening or void for spaces that are in between two openings or voids;
 - no point shall be more than 6m from any opening or void for spaces that are ventilated by such opening or void on only one side; and
 - such vertical openings shall be at least 600mm in height.
 - (iii) The total aggregate area of these voids and vertical openings shall be not less than 20% of the total basement floor area.
 - (iv) An automatic fire alarm system shall be provided for the basement car parks with extension of alarm bells to the common/lobby areas of the upper storeys in accordance with *Cl.6.3.1a.* and *b.*

e. Atrium space

A fire sprinkler system shall be provided for an atrium space not exceeding 18m in height. For an atrium with ceiling height exceeding 18m (in whole or in part), water monitor, deluge and/or extended-throw sprinkler systems shall be provided to cover the entire atrium space.

f. Exemption of sprinkler protection

All of the following areas not located within PG VI or VIII buildings are exempted from sprinkler protection in a sprinkler-protected building:

(1) Canopies/car porches

- (a) Such areas are to be used solely for the purpose of passengers pick-up and drop-off.

- (b) There shall be no commercial activities or storage within these areas.
- (c) Cut-off sprinklers and fire-rated walls are not required to be provided to separate the sprinkler-protected and non-sprinkler-protected areas.

(2) External corridor

External corridors shall not exceed 4m in width, and there shall be no commercial activities or storage within these areas.

(3) External/open-sided linkways

External/open-sided linkways shall not exceed 5m in width, and there shall be no commercial activities or storage within these areas.

(4) Covered areas

Areas which are covered with trellises, louvres or perforated panels, which have 50% or more evenly distributed effective free openings (applicable to all purpose groups).

6.4.2 Standard

Installation of the sprinkler system and its associated water supply, and control and testing requirements shall comply with the SS CP 52.

6.4.3 System design

a. Connection to the SCDF Operations Centre

The sprinkler system shall be electrically monitored so that on the operation of any sprinkler head, the fire signal is automatically transmitted to the SCDF Operations Centre through an approved alarm monitoring company.

b. Fire pumps

Installation of fire pumps for sprinkler systems shall comply with requirements of SS CP 52. Sprinkler pumps shall be installed within a fire compartmented fire pump room, whose fire rating shall be in accordance with [Table 6.4A](#). The sprinkler pump room floor level shall not be lower than the main floor level.

c. Sprinkler control valve

The sprinkler control valve(s) shall be located in one of the following areas:

- (1) Facing an external space within a travel distance of 10m from entrance to the FCC.
- (2) Within a fire lift lobby/smoke-stop lobby.
- (3) Within a sprinkler pump room.
- (4) Within a 1-hr fire-rated enclosure, located at most 10m travel distance from the entrance to the exit staircase.

d. Location plan

A floor plan showing the locations of the sprinkler tank room, sprinkler pump room, breeching inlets and control valves shall be prominently displayed within the FCC. In the absence of the FCC, the floor plan shall be located in the following order of priority:

- (1) within the guard house, or
- (2) next to the main fire alarm panel.

6.4.4 Special purpose rooms

- a. Where a building is required to be provided with an automatic sprinkler system under this Code, parts of the building which are used for purposes stipulated in [Table 6.4A](#) shall be compartmented in accordance with columns 3(a) and 3(b) of the table.
- b. Where a building is not required to be provided with an automatic sprinkler system under this Code, special purpose rooms stipulated in [Table 6.4A](#) shall be compartmented in accordance with columns 2(a) and 2(b).
- c. For the protection of communication nerve centres, data process centres and process control rooms composing of high value computers or telecommunication equipment, if automatic sprinklers are to be replaced by an automatic fire extinguishing system, the enclosure to the hazard or occupancy shall comply with the following:
 - (1) it shall be constructed to have 1-hr fire resistance rating;
 - (2) any door opening shall be protected with a 1-hr fire door;
 - (3) it shall not be provided with more than two exits;
 - (4) the direct travel distance to any exit door of the enclosure shall not exceed 15m; and
 - (5) the fire extinguishing system shall use clean agent and shall conform to [Cl.6.5.2](#).

6.4.5 Car park

In multi-storey buildings under PG II to VIII with an aboveground car park, the provision of fire protection and smoke control systems for the car park shall be in accordance with [Table 6.4B](#).

6.4.6 Water mist systems

Water mist systems can be permitted as a substitute for automatic sprinklers in sprinkler-protected buildings, provided all of the following requirements are complied with:

- a. The water mist system shall be of a propriety design that has been tested to meet the performance requirements of a standard acceptable to the SCDF.

- b. The design and installation of water mist system shall conform to NFPA 750 or AS 4587.
- c. The components of the water mist system shall be listed by a recognised testing laboratory.

6.4.7 Reduced water storage for automatic fire sprinkler system

This reduced water storage is only applicable to existing buildings of habitable height not exceeding 60m, and which have a hazard classification of Ordinary Hazard Group I, II or III under SS CP 52. It shall not apply to new buildings, any building housing storage risks and chemical processes.

a. Design considerations

(1) Tank sizing

The minimum water storage capacity of the sprinkler tank shall be capable of providing adequate water supply for 30 mins of the sprinkler pump operation.

(2) System with reliable inflow

For sprinkler systems with a constant reliable inflow from the town mains to replenish the sprinkler tank, the effective tank storage capacity for the various hazard categories shall be as follows:

TABLE 6.4.7a.(2) : EFFECTIVE TANK CAPACITY FOR RELIABLE INFLOW OF NOT LESS THAN 1.0m ³ /min, & WATER INLET POINT AT REDUCED LEVEL OF 125m OR BELOW		
Occupancy group	System demand**	Minimum effective capacity of storage tank, or 30 mins' storage, whichever is greater
OH1	540 L/min	12.5 m ³
OH2	1000 L/min	25.0 m ³
OH3	1350 L/min	37.5 m ³
<p>Note :</p> <p>** = the upper limit in column 6 of Table 17 of SS CP 52</p>		

(3) System with unreliable inflow

For sprinkler systems with an unreliable inflow from the town mains to replenish the sprinkler tank, the effective tank storage capacity for the various hazards categories shall be as follows:

TABLE 6.4.7a.(3): EFFECTIVE TANK CAPACITY FOR UNRELIABLE INFLOW OF LESS THAN 1.0m ³ /min, OR WATER INLET POINT AT REDUCED LEVEL GREATER THAN 125m		
Occupancy group	System demand**	Minimum effective capacity of storage tank, or 30 mins' storage, whichever is greater
OH1	540 L/min	16.2 m ³
OH2	1000 L/min	30.0 m ³
OH3	1350 L/min	40.5 m ³
<p>Note :</p> <p>** = the upper limit in column 6 of Table 17 of SS CP 52</p>		

(4) Pipe sizing

Full hydraulic calculation methods shall be adopted for the design of the sprinkler system pipework. The sprinkler design must ensure that the flow does not exceed the system demand as stipulated in *Table 6.4.7a.(2)* and *Table 6.4.7a.(3)*, throughout the installation. The flow and pressure limitations can be overcome by employing constant flow pressure reducing valves or by including orifice plates at connections to main distribution pipes.

b. Water supply

(1) Size of incoming mains

The pipe size of the replenishing water mains to the sprinkler storage tank shall not be less than 150mm in diameter. Hydrants, hose reels and external drenchers shall not be connected to the sprinkler system or draw from the sprinkler water supply.

(2) Inlets to storage tank

The inlets to the storage tank shall be fitted with a non-modulating type of pilot float valve listed by the SCDF.

6.4.8 Combined sprinkler and wet riser systems

- a. Combining sprinkler and wet riser systems is permitted provided their design complies with the provisions stipulated in SS CP 52 and SS 575 respectively.
- b. There is no necessity to cater for water storage for the sprinkler system's demand separately.
- c. Pump sets shall be designed for the simultaneous operation of both the sprinkler and wet riser systems.
- d. The combined systems' sprinkler riser and wet riser stacks shall not be interconnected by sprinkler system piping or a single riser that serves both systems.

6.5 FIXED AUTOMATIC FIRE EXTINGUISHING SYSTEMS

6.5.1 Installation

Installation of any fixed automatic fire extinguishing systems which are not deemed to be required by this Code shall not be accepted as substitute of any provision stipulated in this Code unless otherwise approved by the SCDF. Such systems will be considered additional protection for property safety and their installation shall not adversely affect the performance of the stipulated systems.

6.5.2 Design standard

The design and installation of such automatic fire extinguishing systems shall comply with corresponding codes of practice acceptable to the SCDF.

6.6 LIFTS

6.6.1 General

All lift installations and operations shall comply with SS 550.

6.6.2 Lift well ventilation

Lift well shall be vented in accordance with SS 550.

6.6.3 Emergency power supply

- a. Emergency power supply for lighting, ventilation and alarm systems for all lifts shall comply with the requirements in SS 550.
- b. A standby generating plant shall be provided for:
 - (1) homing of lifts during an emergency for:
 - (a) PG II buildings with private lifts or that which exceed the habitable height of 60m;
 - (b) mixed-use residential buildings where the lifts serve the residential and/or non-residential floor(s);
 - (c) PG III to VIII buildings exceeding four storeys; and
 - (d) all basement occupancies;
 - (2) operating of the following lifts during an emergency:
 - (a) fire lifts;
 - (b) evacuation lifts for buildings exceeding four storeys and buildings which require the provision of such lifts for PWDs; and
 - (c) fire escape bed lifts.

- c. The power supply to the lift shall be connected to a sub-main circuit exclusive to the lift and be independent of any other main or sub-main circuits. The power cables serving the lift installation shall be routed through an area of negligible fire risk.

6.6.4 Fire lift

a. General

- (1) The installation of the fire lift shall be in accordance with SS 550.
- (2) The fire lift(s) shall be contained within a separate protected shaft. Alternatively, the fire lift(s) can be contained within a common protected shaft containing other lifts, provided such other lifts are served at each storey by the fire lift lobby.
- (3) The fire lift shaft shall be continuous throughout the building and serve every storey except a non-habitable roof.
- (4) A lift mainly intended for the transport of goods shall not be designated as a fire lift.
- (5) Cargo lift shall not open into a fire lift lobby.

b. Number of fire lifts

- (1) With the exception of PG I and II buildings, all other buildings shall be provided with at least two fire lifts if the habitable height exceeds 24m.
- (2) For PG II buildings, at least one fire lift shall be provided if the habitable height exceeds 24m. In the case of super high-rise (above 40 storeys) residential buildings, at least two fire lifts shall be provided.
- (3) All buildings, except PG I, shall also be provided with at least two fire lift if the depth of the basement exceeds 9m below the average grade level.

c. Accessibility and coverage

- (1) A fire lift shall be located such that the travel distance between the nearest edges of the lift landing door and exit staircase door is not more than 5m. In addition, the exit staircase shall be approached through a fire lift lobby at each storey
- (2) The fire lift shall be located such that any part of every storey shall be accessible by firefighters from the fire lift.
- (3) Regardless of whether the building is installed with an automatic sprinkler system, the number of fire lifts required shall be such that any part of a storey of the building is within 60m coverage from the fire lift door, subject to the provision of at least two fire lifts in accordance with *Cl.6.6.4b.(1) & (3)*.

d. Fire lift switch

- (1) The operational features of the fire lift shall be provided in accordance

with SS 550, including the provision of a fire lift switch.

- (2) A fire lift switch shall be provided at both the designated and alternate designated floors.

6.6.5 Evacuation lift

a. General

Evacuation lifts shall be provided for evacuation of occupants requiring assistance during an emergency. The requirements stipulated herein shall be applicable to all, except PG I and II, buildings:

- (1) exceeding 24m in habitable height, or
- (2) accessible to PWDs, except those stipulated under *Cl.2.4.1a..*

b. Provisions

- (1) For buildings provided with at least two fire lifts, one of the fire lifts can be used for the evacuation of occupants, including PWDs.
- (2) Where a fire lift serves the dual purpose of an evacuation lift for PWDs, it shall have a clear car platform area of minimum 1.2m by 1.4m instead of 1.45m². For PG II buildings having more than 40 storeys, the minimum clear car platform size of the fire lift shall be at least 1.7m by 1.5m.
- (3) For buildings without a fire lift, at least one of the passenger lifts shall be designated as a PWD evacuation lift.
- (4) All passenger lifts in buildings exceeding 24m in habitable height shall be designed for use together with the fire lifts so as to speed up occupant evacuation.

c. Communication

- (1) A lift monitoring system shall be provided within the FCC. It shall monitor the floor location of the lift, direction of travel, status with respect to occupation, both the normal and emergency power supplies to the lifts, and activation of a fire alarm within the lift shaft or lift motor room or lift lobby. Provision to manually override the lift shall be installed in the FCC for use by the firefighters/CERT if required.
- (2) A voice communication system shall be provided in the building.
- (3) An intercom system in the lift car shall be provided for communication between the lift operator and the FCC.
- (4) CCTV cameras shall be installed at lift lobbies to facilitate situational awareness for the authorised personnel overseeing the evacuation at the FCC or 24-hourly manned station. Alternatively, a suitable means of communication to call for assistance during a fire can be provided between the protected lobby and FCC or any 24-hourly manned station. It can be in the form of a distress button or voice communication.

- (5) The means of communication shall:
 - (a) be located between 800mm and 1200mm above ground level;
 - (b) be appropriately labelled;
 - (c) be provided with prominently displayed clear instruction signage on its operation; and
 - (d) when activated, generate a clear visual indication for the person requesting for assistance to know that the distress signal has been relayed.

d. Evacuation switch

- (1) A switching device, similar to the fire lift switch, shall be installed next to each evacuation lift landing door on the designated floor (and the alternate designated floor, if provided) for persons authorised by the building owner or firefighters to activate the evacuation mode of the lift.
- (2) Under the evacuation mode, the lift operation shall be similar to the firefighters service operation as stipulated in the SS 550.
- (3) The switching device shall be housed in a breakable glass-fronted box marked “Evacuation Switch”.

e. Signage

- (1) For buildings provided with a PWD evacuation lift, a prominent sign marked “Evacuation Lift” shall be affixed onto the wall adjacent to the lift door at every landing of the evacuation lift.
- (2) The size of the letters shall not be less than 25mm in height.

f. Protected lobby

- (1) Evacuation lifts shall be located within a protected lobby such as a smoke-stop lobby, external exit passageway or external corridor.
- (2) For buildings not exceeding 4 storeys, the provision of a protected lobby for PWD evacuation lift is not required. However, should passenger lifts be installed in such buildings, these lifts shall be provided with a lift evacuation switch for use by emergency responders. If there is no protected lift lobby provided for the said passenger lifts, the PWD Holding Point shall be located inside a protected exit staircase or along the external corridor.

g. Secondary evacuation lifts

- (1) All passenger lifts in buildings exceeding 24m in habitable height shall comply with all of the following requirements:
 - (a) A secondary evacuation switch (labelled accordingly) shall be provided at the FCC for each passenger lifts.

- (b) Power cables shall be routed through an area of negligible fire risk.
- (c) Close circuit television shall be provided at all lift lobbies.
- (2) The passenger lifts provided with a secondary evacuation switch need not be backed up by a secondary source of supply for evacuation operation.

6.6.6 Homing of lifts

a. For buildings requiring fire alarm system

- (1) In a fire emergency, when any one of the fire detection devices or fire alarm systems is activated, all the lifts, including passenger, service, designated fire and designated evacuation lifts, shall be brought to the designated floor (usually 1st storey). Otherwise, the lifts shall home to an alternate designated floor (if the designated floor is a fire floor) and park with the lift landing doors remaining opened.
- (2) Goods lifts with automatic doors shall be similarly homed to the designated floor.
- (3) Goods lifts with manual doors shall be homed if the doors are closed.

b. For buildings requiring standby generating plants

- (1) In the event of power failure or power interruption in the building, the supply to the lifts shall be automatically switched over to the emergency power supply from the generating plant.
- (2) The lifts shall be brought to the designated floor and park with the lift landing doors remaining open until all the lifts have been brought down to the designated floor.
- (3) Thereafter, one or more lifts can resume operation depending on the capacity of the emergency generating plant, in addition to the fire lift.
- (4) Normal operation of the lift shall be automatically reset on the return of normal power supply.

c. For buildings which do not require standby generating plants, and for buildings with standby generating plants but without automatic fire alarm or sprinkler system

- (1) For buildings without standby generating plants, the smoke/heat detectors shall form part of the lift system and shall be connected to the lift control panel to home the lift under normal power upon activation. All lifts, including hydraulic lifts, shall be provided with Automatic Rescue Device (ARD). The ARD shall permit the lifts to move and park at the nearest lift landing floor with the lift/landing doors open in the event of power failure. Homing any of the lifts to a basement storey is not permitted.
- (2) Smoke/heat detectors shall be provided at all lift lobbies such that all lifts serving the same lobby shall be brought to the designated floor or

alternate designated floor upon activation of the detectors. For buildings without a fire alarm system, the smoke/heat detectors shall form part of the lift system and shall be connected to the lift control panel to home the lift under normal power upon activation.

d. For mixed developments comprising residential and non-residential components

- (1) All lifts which serve the residential and non-residential floors shall be required to home to the designated or alternate designated floor (if the designated floor is a fire floor) in the event of power failure and/or fire. The lifts shall be provided with secondary power supply from standby generating plant of sufficient capacity.
- (2) Where the passenger lifts serve only the residential floors and by-pass the non-residential floors in a protected shaft, the lifts shall be required to be installed with Automatic Rescue Device (ARD), provided the habitable height of the highest floor does not exceed 60m.
- (3) Where the lifts serve the upper residential floors and the basement non-residential floor(s), including car parks, the lifts shall be provided with emergency power supply from a standby generating plant for homing to the designated floor when there is a power failure in the building. In a fire emergency, the lifts shall be brought to the designated floor or alternate designated floor (if the designated floor is a fire floor) when any of the fire alarm systems in the basement non-residential floor(s) is activated.

e. Requirements for alternate designated floor

- (1) An alternate designated floor (e.g. 2nd storey) shall be identified.
- (2) The lifts shall be brought to the alternate designated floor in the event of a fire at the designated floor.
- (3) **Localised detectors**
 - (a) Localised detector(s) shall be provided to cover the lift landing space at the designated floor.
 - (b) The activation of any of the localised detectors or any other detectors or sprinklers covering the designated floor shall cause all the lifts to be re-directed to home to the alternate designated floor.
 - (c) The localised detector(s) shall cover the area within at least 3m surrounding the lift landing door opening.
 - (d) Where the lift landing is protected by a fire-rated enclosure, only the space within the enclosure is required to be covered by localised detector(s).
- (4) The alternative alternate floor shall have minimum fire hazard and pre-selected for the homing of passenger lifts, and where people can escape to safety in an exit staircase or other exit from the lift landing door.

- (5) In building under *Cl.6.6.6c.* which are not provided with sprinklers or automatic fire alarm system, suitable sensors shall be provided at the ceiling level to cover the lift landing space. The activation of any sensor shall cause the lifts to be re-directed to home to the alternate floor.
- (6) The above requirements on homing of lifts to an alternate designated floor need not be applied to standalone open-sided car parks and residential buildings under PG I.

6.6.7 Provisions for lift rescue

a. General

The following requirements shall apply to buildings with blind lift hoist ways exceeding 11m, except for PG I buildings. They shall be read in conjunction with SS 550.

b. Rescue hooks

- (1) When the distance between consecutive lift landing doorsills is more than 11m but less than 18m (see *Diagram 6.6.7b.(1) – 1*), rescue hooks complying with *Cl.6.6.7b.(3)* shall be provided at the underside of the upper lift landing door head (see *Diagram 6.6.7b.(1) – 2*).
- (2) Alternatively, these hooks shall be installed in the ceiling space directly above the upper lift landing door, such that the heights of these hooks are not more than 3m above the finished floor level of that upper lift landing, and at an approximate distance of 1m away from the lift shaft wall. The ceiling space shall be easily accessible, and a sign shall be provided to indicate the locations of the rescue hooks (see *Diagram 6.6.7b.(2) – 1 & 2*).

(3) Rescue hook design

Each rescue hook shall have pull-out strength of at least 1000kg (10kN) and a thickness of at most 14mm in diameter. The clear space between the hook and the emergency door frame shall not be less than 100mm, and the spacing between the two hooks shall be between 500 to 700mm. (see *Diagram 6.6.7b.(3)*).

c. Landing emergency doors

- (1) Where the distance between consecutive lift landing doorsills exceeds 18m, intermediate landing emergency doors shall be provided, such that the distance between sills is at most 18m. However, for adjacent cars fitted with car emergency doors complying with *Cl.6.6.7d.*, intermediate landing emergency doors are not required.
- (2) The landing emergency doors shall conform to all of the following requirements (see *Diagram 6.6.7c.(2)*):
 - (a) They shall form a clear opening of at least 760mm wide and 2m high.

- (b) They shall be easily accessible and free from fixed obstructions.
- (c) They shall be either of the horizontally sliding or swinging single-leaf type.
- (d) They shall be self-closing and self-locking and shall be marked in letters not less than 50mm high: "DANGER, LIFT WELL".
- (e) They shall be provided with a landing door lock which can be unlocked only from the landing side through the use of a key. The lock shall not be unlocked by any key which will open any other lock or device used for any other purpose in the building. The key shall be kept where it is accessible only to authorised persons.
- (f) Each door shall be provided with an electrical contact, the opening of which will render the lift inoperable.
- (g) Two rescue hooks complying with *Cl.6.6.7b.(3)* shall be provided at the underside of each emergency door head. Alternatively, these hooks can also be installed in the ceiling space as stipulated under *Cl.6.6.7b.(2)*.

d. Car emergency doors

- (1) When car emergency doors are provided in adjacent cars to permit the lift-to-lift rescue and evacuation of passengers, there is no limit on the maximum allowable length of the blind lift hoist way. (See *Diagram 6.6.7d.(1)*)
- (2) When car emergency doors are provided, all of the following requirements shall be complied with (see *Diagram 6.6.7d.(2)*):
 - (a) The horizontal distance between cars shall not exceed 750mm.
 - (b) Car emergency doors shall measure at least 1.8m high and 350mm wide.
 - (c) Car emergency doors shall be openable from outside the car without a key and from inside the car using a key.
 - (d) Car emergency doors shall open towards the inside of the car.
 - (e) Car emergency doors shall not be located in the path of a counterweight or in front of a fixed obstacle (except for beams separating the cars) preventing passage from one car to another.
 - (f) A set of detachable bridging plate and handrail, painted in bright yellow, shall be provided and secured to each emergency door. The plate shall have an anti-slip surface and means shall be provided to prevent accidental dropping of the plate and handrail into the lift well during deployment.
 - (g) The detachable bridging plate shall have a minimum loading capacity of 200kg and shall not weigh more than 10kg. The

maximum loading capacity shall be clearly marked on the top-face of the plate. Means shall be provided to prevent the plate and handrail from slipping off when deployed.

- (h) Each car emergency door shall be provided with an electrical contact, the opening of which will render the lift inoperable. A safety feature to prevent the lift from operating when the bridging plate or the handrail is deployed shall also be provided.

6.7 COLOUR SCHEME OF FIRE PROTECTION SYSTEMS

6.7.1 Equipment, fixtures and fittings

The following equipment/fixtures/fittings for the fire protection systems shall be painted in red. For those equipment/fixtures/fittings not listed below, the colour scheme shall be in accordance with that specified in the relevant codes of practice.

a. Fire sprinkler system

- (1) Fire pump & control panel
- (2) Breeching inlet (excluding breeching inlet cabinet/enclosure)
- (3) Sprinkler control valve
- (4) Sprinkler water proofing system/device

b. Electrical fire alarm system

- (1) Main fire alarm panel/cabinet
 - (2) Sub fire alarm panel/cabinet
 - (3) Manual call point
 - (4) Visual alarm light housing
- (Note: fire alarm bell need not be in red)

c. Private fire hydrant

- (1) Wet pillar hydrant (with yellow band in accordance with SS 575)
- (2) Dry pillar hydrant (whole hydrant in yellow)

d. Wet/dry rising mains

- (1) Fire pump & control panel
- (2) Breeching inlet (excluding breeching inlet cabinet/enclosure)
- (3) Rising mains pipe
- (4) Landing valve
- (5) Standby hose cabinet/enclosure

e. **Hose reel system**

- (1) Hose reel pump & control panel
- (2) Hose reel drum (excluding cabinet/enclosure)

f. **Total flooding fire extinguishing system**

- (1) Manual release control
- (2) Abort switch
- (3) Breathing apparatus cabinet/enclosure

g. **Emergency Voice Communication System**

Handset/cabinet/enclosure

h. **Fire extinguisher**

Housing cabinet/enclosure

(Note: Alternatively, red graphic signage or red wordings “Fire Extinguisher” of minimum size 20mm shall be provided.)

i. **Electromechanical locking system (for exit and exit access door)**

Emergency door release

6.7.2 Pipework, conduits, trunkings and cable trays

For fire protection systems pipework/conduits/trunkings/cable trays which are not required to be painted in red, red colour bands of width not less than 20mm and labelling shall be provided at an interval of not more than 6m apart.

6.8 REDUNDANCY FOR FIRE PUMPING SYSTEM

The pumping system for wet rising mains, hose reels, sprinklers and hydrants shall be provided with redundancy such that the system performance is not affected when one of the pumps and/or the associated control system is out of operation due to routine maintenance or break-down.

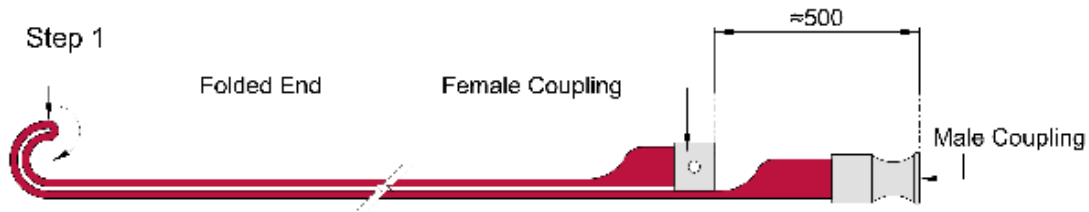

- a. Fold the fire hose into half with the male and female coupling around 500mm apart.
- b. Roll the fire hose at the "folded" end, not coupling end.



- c. Ensure the fire hose is rolled in a compacted manner

- Step 3**
- d. A velcro strap is required to be secured on the Dutch Roll Fire Hose as indicated
 - e. Place the fire hose into a cabinet

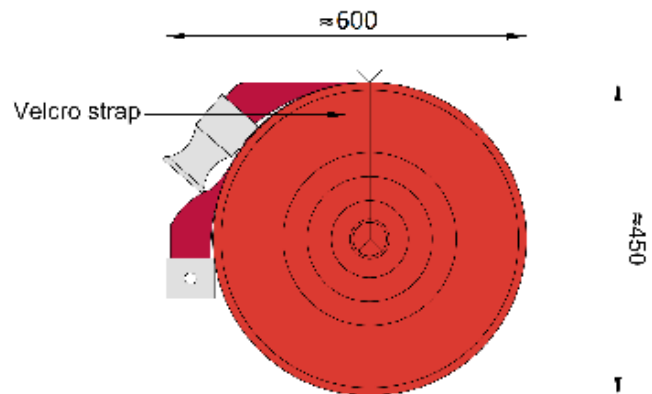

[Diagram 6.2.5a.\(3\) : Dutch roll folding method](#)

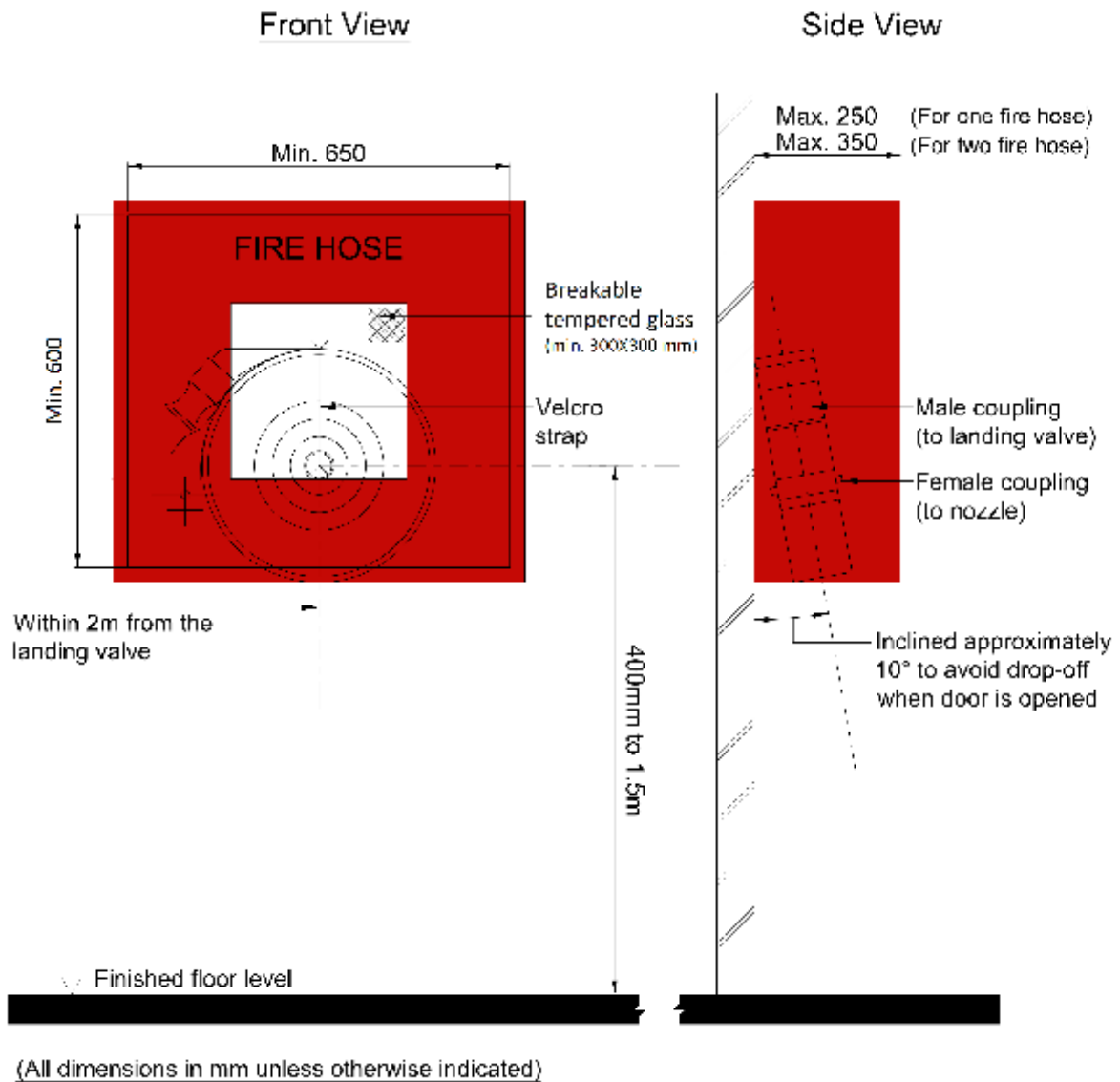

[Diagram 6.2.5b.\(1\) : Dutch-rolled fire hose with cabinet \(surface-mounted or recessed\)](#)

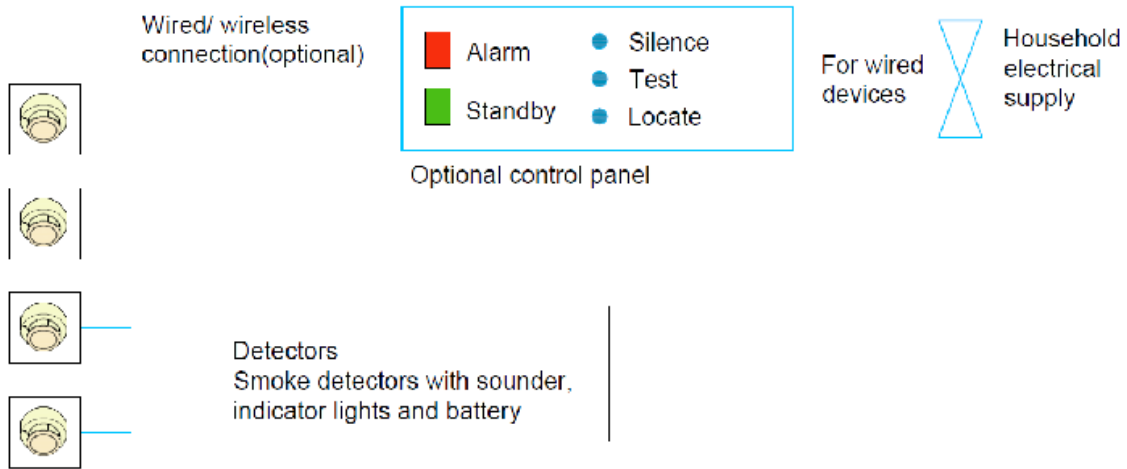

[Diagram 6.3.6a.\(8\) : Home fire alarm system](#)

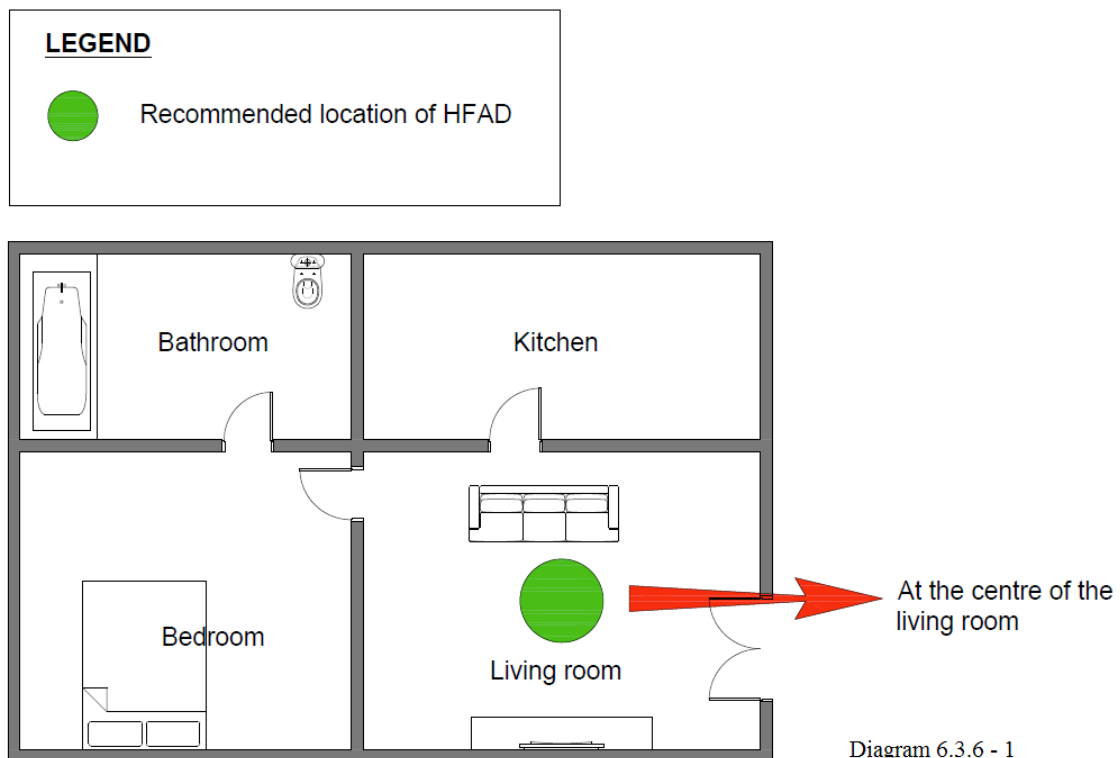

Location of HFAD installation in single storey home

[Diagram 6.3.6c. - 1: Location of HFAD installation in single storey home](#)

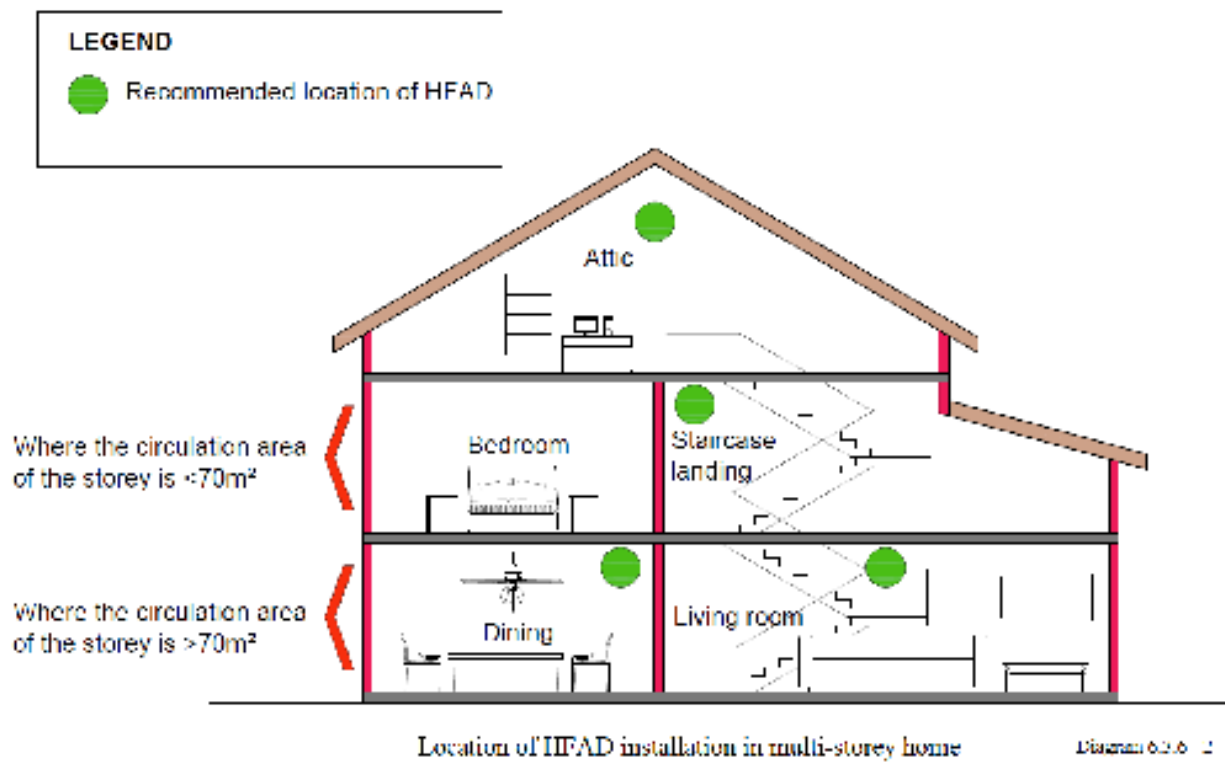

[Diagram 6.3.6c. - 2: Location of HFAD installation in multi-storey home](#)

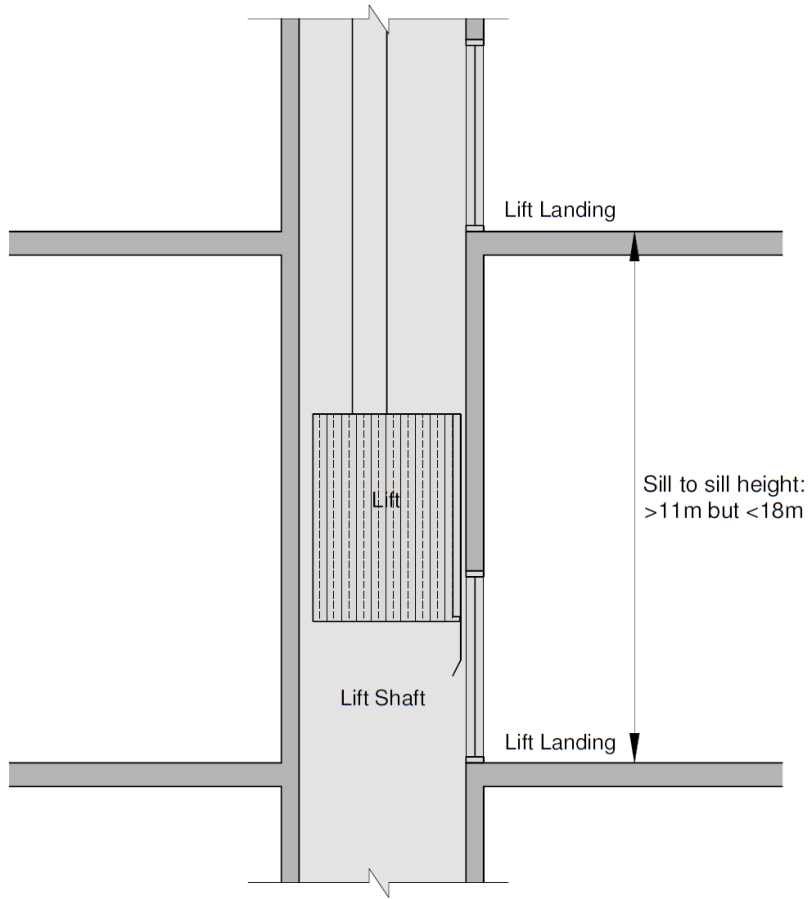

[Diagram 6.6.7b.\(1\) – 1 : Lift landing sill to sill distance >11m but <18m](#)

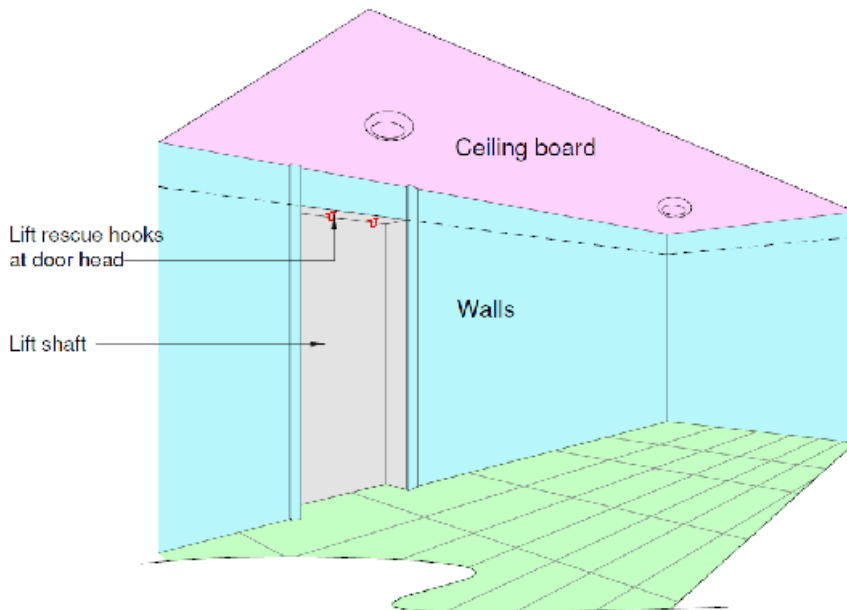

[Diagram 6.6.7b.\(1\) – 2 : Rescue hooks located at lift landing](#)

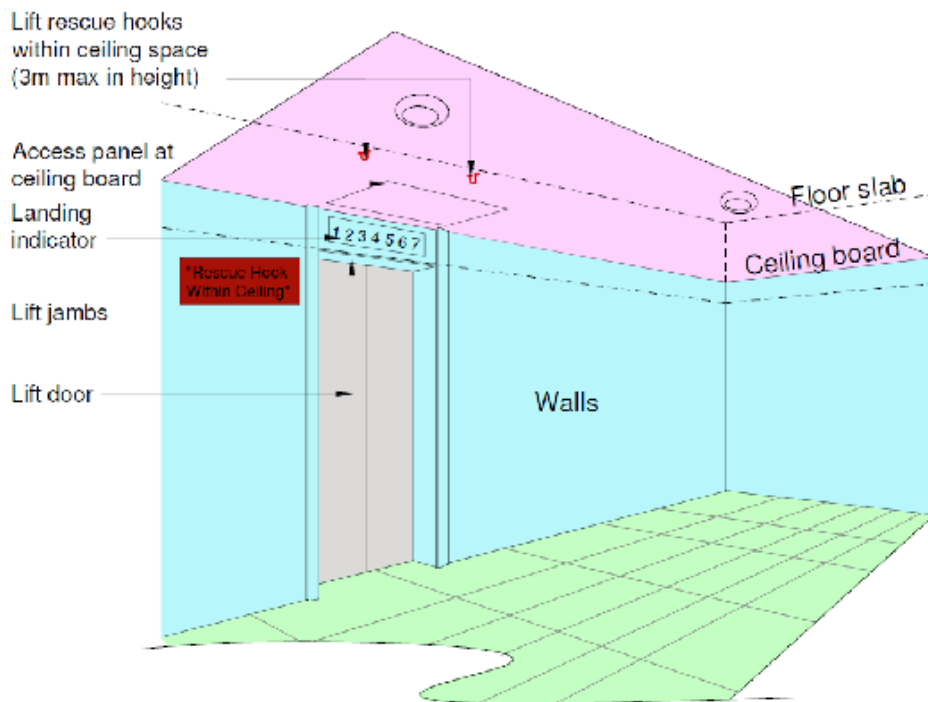

[Diagram 6.6.7b.\(2\) – 1 : Rescue hooks located within lift landing ceiling space](#)

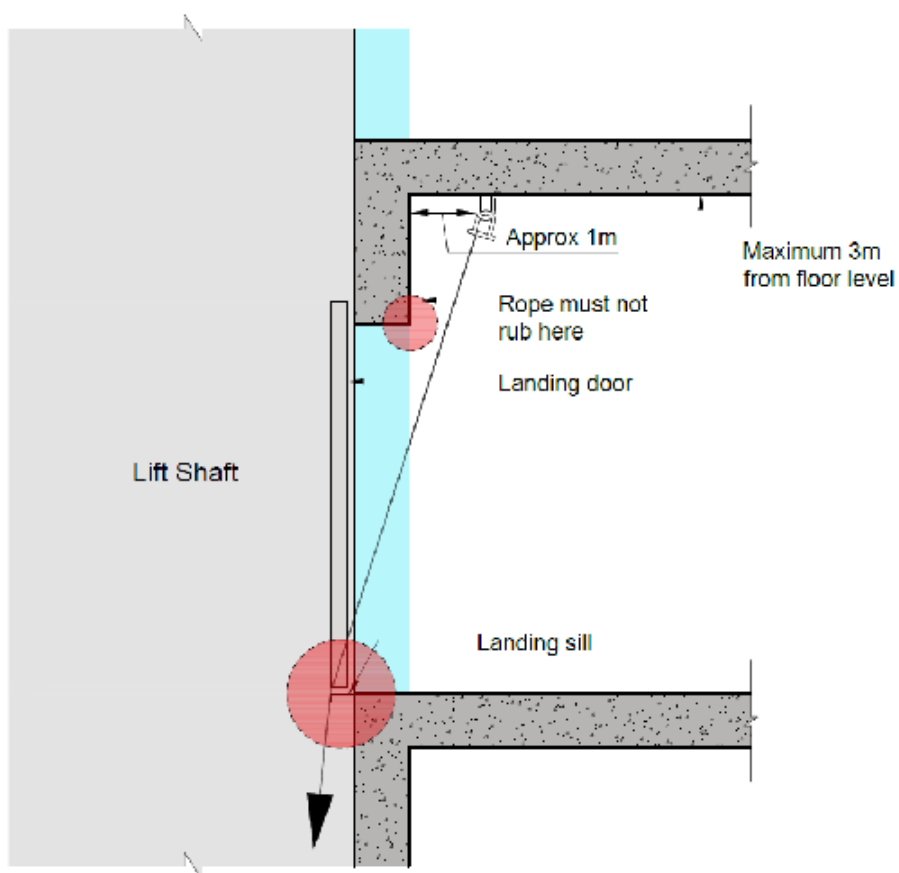

[e](#)

[Diagram 6.6.7b.\(2\) – 2 : Rescue hooks located within lift landing ceiling space](#)

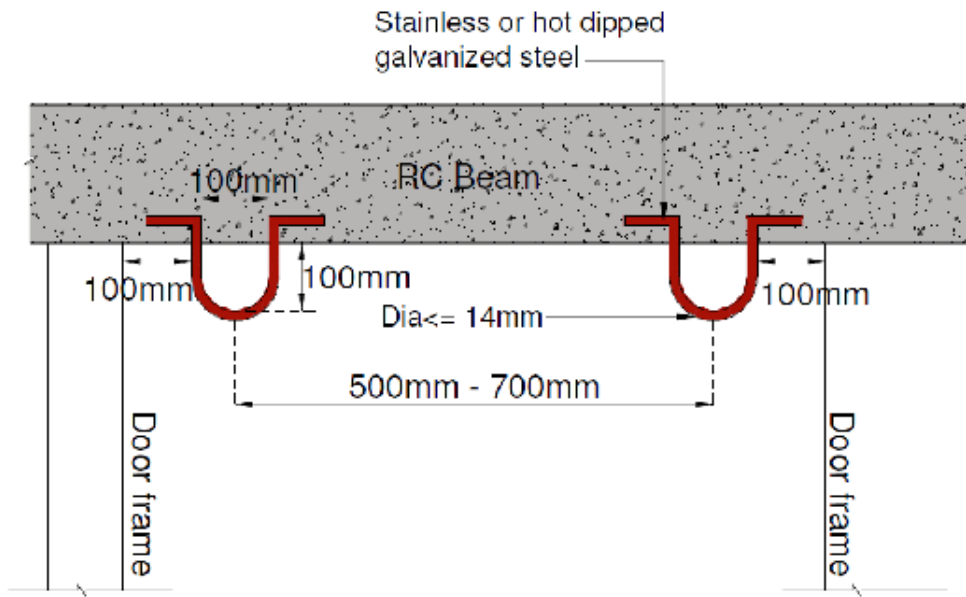

Note: Pull down capacity = 10KN

[Diagram 6.6.7b.\(3\) : Rescue hook design](#)

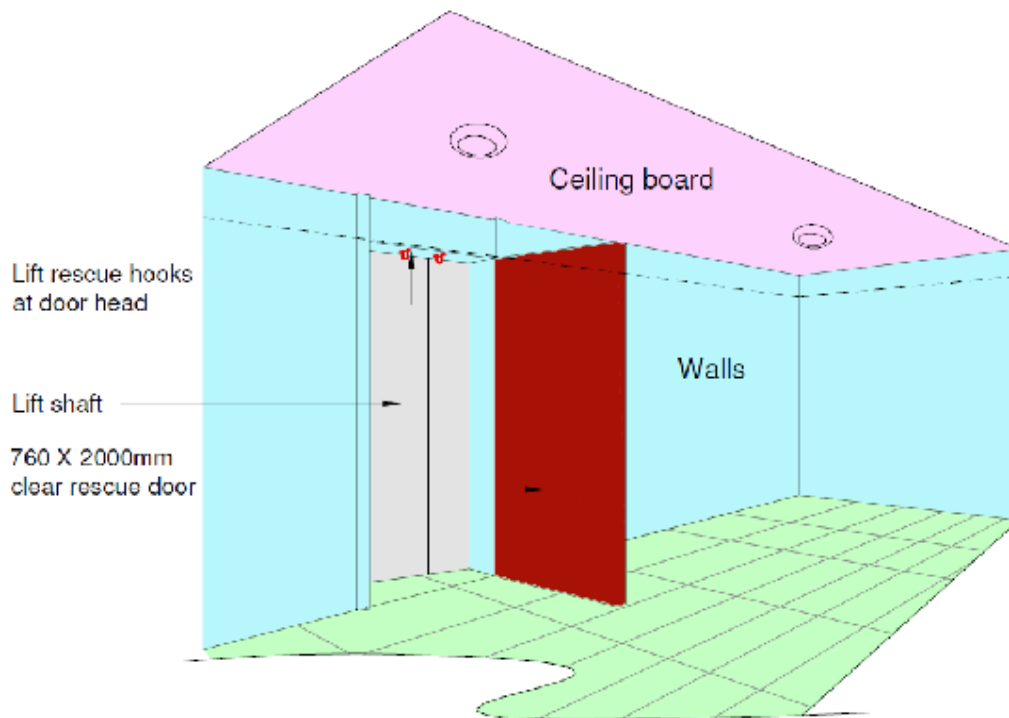

[Diagram 6.6.7c.\(2\) : Landing emergency door](#)

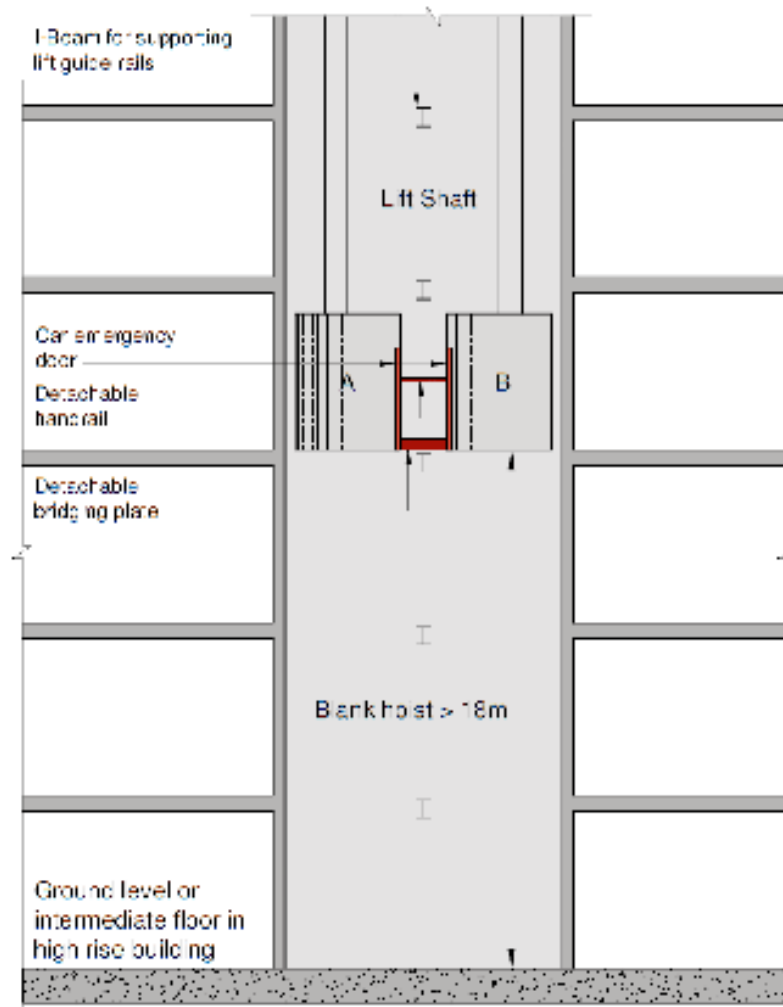

[Diagram 6.6.7d.\(1\) : Car emergency doors for lift-to-lift rescue](#)

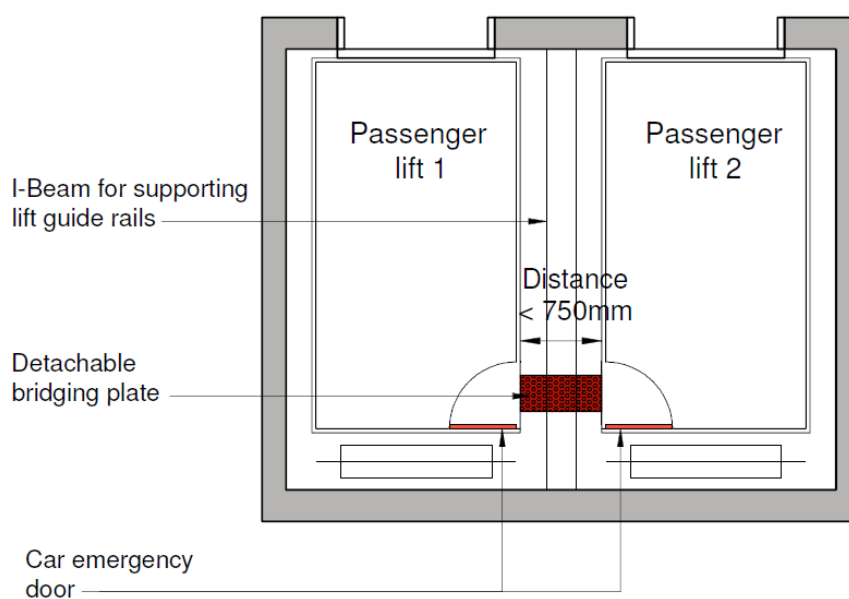

[Diagram 6.6.7d.\(2\) : Car emergency doors - Deployment of bridging plate](#)

**TABLE 6.3A
PROVISION OF FIRE ALARMS ACCORDING TO PURPOSE GROUP,
HEIGHT & SIZE OF THE BUILDING**

Purpose group (1)	Building type (2)	Total floor area per storey (3)	Type of fire alarm system (4)
PG I & II	NR	NR	HFAD
PG III to VIII (Without stay-in facilities)	Single storey building	>400m ²	Manual*
	Building of 2 to 4 storeys	>200m ²	Manual*
	Building of more than 4 storeys	NR	Automatic + manual
PG III to VIII (With stay-in facilities)	Single storey building	NR	Manual**
	Building of more than one storey	NR	Automatic + manual

Note :

NR = Not Relevant

* = Except otherwise exempted under *Cl.6.3.3d*.

** = Healthcare occupancy with patient accommodation ward, nursing home, convalescent home, home for the aged and hospice shall be provided with both automatic fire alarm system and manual fire alarm system. See *Cl.9.3.2b.(5)(b)*.

1. When there are 2 or more purpose groups in a building, the strictest requirement for any one of the purpose groups shall be applicable to the whole building.
2. Where PG II forms part of a mixed-use building, *Cl.6.3.1b.(1)* shall be followed and HFAD shall be provided in the residential units.
3. Where access control using smart card locking device, magnetic bar or electromechanical locking device are installed at fire-rated door(s) of an exit staircase and smoke-stop/fire lift lobby, such devices shall be linked directly to the building fire alarm system or sprinkler system. Linking of the locking devices through other systems to the building fire alarm system or sprinkler system is not permitted.

TABLE 6.4A : COMPARTMENTATION REQUIREMENTS FOR SPECIAL PURPOSE ROOMS IN BUILDINGS

Usage (1)	Non sprinkler-protected building		Sprinkler-protected building		
	Compartmentation (2a)	Door rating (2b)	Compartmentation (3a)	Door rating (3b)	Sprinkler (3c)
Store room ⁽¹⁾	1 hr	1 hr	N	N	S
AHU room ⁽³⁾	N	N	N	N	S
Kitchen ⁽²⁾	1 hr	1/2 hr	1 hr	1/2 hr	S
Boiler room (oil fired)	2 hr	2 hr	1 hr	1 hr	S
Low voltage switch room	B	B	B	B	Ex
High voltage switch room	B	B	B	B	Ex
Transformer room	2 hr	2 hr	1 hr	1 hr	Ex
Oil tank room	2 hr	2 hr	1 hr	1 hr	S
Generator room	2 hr	2 hr	1 hr	1 hr	S
AC plant room	2 hr	2 hr	1 hr	1 hr	S
Electric lift motor room	2 hr	2 hr	2 hr	2 hr	Ex
Hydraulic lift motor room	2 hr	2 hr	1 hr	1 hr	S
Essential fan room	2 hr	2 hr	1 hr	1 hr	S
Electrical room	2 hr	2 hr	2 hr	2 hr	Ex
Battery room	2 hr	2 hr	2 hr	2 hr	Ex
Sprinkler/Wet riser tank room	B	B	B	B	S
Fire pump room	B	B	B	B	S
Fire Command Centre	2 hr	2 hr	2 hr	2 hr	S
MDF room	N	N	B	B	Ex
			N	N	S
PABX room	N	N	B	B	Ex
			N	N	S

Note :

The fire resistance rating stipulated in this table shall be the minimum.

N = no specific requirement on compartmentation/door rating.

B = compartmentation/door rating shall not be less than the fire resistance of the elements of structure of the building where the room is located.

S = Sprinkler system has to be extended into such rooms.

Ex = Sprinkler system is exempted from the corresponding area provided the area is fitted with an automatic fire alarm system installed according to SS CP 10.

(1) = Requirements stated herein apply to store room which is required to be compartmentalised.

(2) = Requirements stated herein apply to kitchens in hotel, restaurant, coffee house or other similar places where the preparation of food is required. However, special considerations will be given to the followings:

(a) kitchens where open flame cooking appliances are NOT used, or

(b) kitchens where all the cooking facilities are fitted with approved extinguishing systems.

(3) = Where AHU rooms are vertically stacked, each AHU room shall be separated by a compartment floor at every level. In the case of AHU serving more than one compartment, fire dampers shall be provided in air ducts at penetration through the compartment wall and floors, see [Cl.7.1.8](#).

TABLE 6.4B VENTILATION, SMOKE PURGING SYSTEM & AUTOMATIC FIRE SPRINKLER SYSTEM REQUIREMENTS FOR ABOVEGROUND CAR PARKS (STANDALONE OR WITHIN BUILDINGS)										
Habitable Height		Criteria for the largest car park compartment			Ventilation in compliance with Cl.3.2.8	Smoke purging system	Automatic fire sprinkler system	Type of fire alarm system		
Building	Car park	Area	Cubical extent	No. of storey				Auto	Manual	
≤ 24m		≤ 4000m ²	≤ 15000m ³	≤ 3-storey	NR	NR	NR ⁽²⁾	NR ⁽¹⁾	NR	
		Area > 4000m ² and ≤ 5000m ²			Comply	NR	NR ⁽²⁾	R	NR	
	≤ 24m	≤ 24m	Cubical extent > 15000m ³			Comply	NR	NR ⁽²⁾	R	NR
			Area > 5000m ² or more than 3 storey			Not comply	R	R	NR	NR
> 24m		≤ 4000m ²	≤ 15000m ³	≤ 3-storey	NR	NR	R	NR	NR	
		Area > 4000m ² & ≤ 5000m ²			Comply	NR	R	NR	NR	
	> 24m	Any	Cubical extent > 15000m ³			Comply	NR	R	R	NR
			Area > 5000m ² or more than 3 storey			Not comply	R	R	NR	NR

Note:
 NR = Not required
 R = Required
⁽¹⁾ = Automatic fire alarm system shall be extended to the car park if the building is protected with automatic fire alarm system
⁽²⁾ = Sprinkler shall be extended to the car park if the building is protected with automatic fire sprinkler system

The background of the entire page is a detailed architectural floor plan of a building. The plan shows various rooms, corridors, and structural elements. Some rooms are labeled with text such as 'OFFICE', 'MEETING ROOM', and 'RECEPTION'. The lines of the floor plan are thin and light gray, creating a complex geometric pattern across the page.

CHAPTER

07

**MECHANICAL VENTILATION &
SMOKE CONTROL SYSTEMS**

CHAPTER

7

MECHANICAL VENTILATION &
SMOKE CONTROL SYSTEMS

7.1 AIR-CONDITIONING AND MECHANICAL VENTILATION SYSTEMS

7.1.1 General

Where an air-conditioning system is provided in lieu of a mechanical ventilation system for emergencies, all the requirements specified in this Code for mechanical ventilation systems shall apply to the air-conditioning system.

7.1.2 Construction of ductwork

Ducts for air-conditioning and mechanical ventilation systems shall be constructed in compliance with all of the following requirements:

a. Materials

Air-conditioning or other ventilation ducts, including framing thereof, shall be constructed of steel, aluminium, glass fibre batt or mineral wool batt or other approved materials.

b. Support

Air-conditioning or other ventilation ducts shall be adequately supported.

c. Duct linings & coverings

Duct covering and lining shall be non-combustible. However, if it is necessary to use combustible material, it shall:

- (1) when tested in accordance with methods specified in this Code, have a surface flame spread rating of not lower than Class 1, except in areas of a building where Class 0 flame spreading rating is required for the ceiling construction under this Code, a Class 0 rating for the covering and lining materials shall instead be required;
- (2) when involved in fire, generate a minimum amount of smoke and toxic gases; and
- (3) be at least 1m away from a fire damper.

d. Flexible joints and connections

- (1) Flexible connections at the ends of ventilation ductwork connecting terminal units, extract units and ventilation grilles shall not exceed 4m.
- (2) Flexible joints, which are normally provided to prevent and/or allow for thermal movements in the duct system, shall not exceed 250mm in length.

- (3) Flexible joints shall be made of material classified as 'not easily ignitable' when tested under BS 476: Part 5.

e. **Duct enclosure**

Enclosure of ducts shall comply with the requirements in *Cl.3.8.9a.*

f. **Ductwork through smoke-stop or fire lift lobbies**

Ventilation ducts should not pass through smoke-stop or fire lift lobbies. Where unavoidable, the part of the ventilation duct within the lobby shall be enclosed in masonry construction with fire resistance rating at least equal to that of the elements of structure. If other forms of fire resisting construction are used, a fire damper shall be fitted where the duct penetrates the lobby enclosure.

g. **Ductwork through separating walls**

No air-conditioning or ventilation duct shall penetrate separating walls.

h. **Fire-rated duct**

- (1) Where proprietary fire-rated materials are used to construct the fire-rated duct, the fire rating of the fire-rated duct shall have the same period of fire resistance as the wall or floor it penetrates.
- (2) Proprietary fire-rated duct shall be tested to BS 476 Pt 24 or equivalent and its usage be approved by the SCDF.
- (3) Running of non-fire-rated duct and/or other building services above the proprietary fire-rated duct should be avoided. When unavoidable due to physical constraints, the supports to such non-fire-rated duct and/or other building services running above the proprietary fire-rated duct shall be strengthened, such that the tensile stress generated on the supports shall not exceed 10N/mm². The non-fire-rated duct and/or building services shall also be adequately protected to prevent collapse in a fire which will otherwise affect the stability of the proprietary fire-rated duct below.
- (4) Fans forming part of a fire-rated duct shall also be enclosed in the same fire-rated enclosure.
- (5) Control panels serving engineered smoke control and smoke purging systems shall be clearly visible and located within a common location readily accessible for operation and maintenance, preferably within circulation space, with a mounting height of not less than 1.5m or more than 1.8m from the finished floor level. For smoke purging systems in car parks, the control panel shall be sited at least 1.5m away from any car park lot or other fire hazards.

If a common accessible location is not possible, the control panels shall be protected with at least 1-hr fire resistance rating.

7.1.3 Pipework

Insulation for pipework associated with the air-conditioning and mechanical

ventilation systems shall comply with the following requirements:

a. Flame spread rating

Insulation material for pipework, together with vapour barrier lining and adhesives shall, when tested in accordance with the methods specified in this Code, have a surface flame spread of not lower than Class 1. However, in areas of buildings where Class 0 flame spread is required for the ceiling construction under this Code, a Class 0 rating for the insulation material shall be required.

b. Plastic and foam rubber insulation

Notwithstanding the requirements of *Cl. 7.1.3a.*, the use of plastic and foam rubber insulation materials of a lower classification is permitted if:

- (1) it is of the self-extinguishing type; and
- (2) the insulation is covered by or encased in a metal sheath or hybrid plaster or other non-combustible cladding material,

provided that any opening in the element of structure or other part of a building penetrated by the pipework shall be effectively fire-stopped by replacement of the insulation material at the junction of penetration with fire resistant material having equal fire resistance rating. A fire-rated proprietary pipework system can be used if it is tested in the manner acceptable to the SCDF.

7.1.4 Air plenum

A concealed space between the ceiling and floor above it, ceiling and roof, or raised floor and structural floor of a building can be used as a plenum provided:

a. The concealed space contains only:

- (1) mineral insulated metal sheathed cable, aluminium sheathed cable, copper sheathed cable, rigid metal conduit, enclosed metal trunking, flexible metal conduit, liquid tight flexible metal conduit in lengths not more than 2m, or metal-cladded cables;
- (2) electric equipment that is permitted within the concealed spaces of such structures, if the wiring materials, including fixtures, are suitable for the expected ambient temperature to which they will be subjected;
- (3) other ventilation ducts complying with *Cl. 7.1.2a. to d.*;
- (4) communication cables for computers, television, telephone and inter-communication systems;
- (5) fire protection installations; and
- (6) pipes of non-combustible material conveying non-flammable liquids.

b. The supports for the ceiling membrane are of non-combustible material.

c. **Exception**

Low-smoke and low-flame plenum rated PVC cables conforming to NFPA 262 can be run exposed in plenum, provided that:

- (1) the plenum space is protected by a sprinkler system or gaseous total flooding system; and
- (2) a FCU or AHU using a plenum for air return and serving more than one room, is installed with smoke detector(s) at the return air plenum space to shut down the FCU/AHU upon detection of smoke.

7.1.5 Fire Dampers

Any fire damper shall have a fire resisting rating of not less than that required for the compartment wall or compartment floor through which the relevant section of the ventilation duct passes. Fire dampers shall be of the type approved by the SCDF and constructed in accordance with the requirements in SS 333.

a. **Provision of fire dampers**

Ventilation ducts which pass directly through a compartment wall or compartment floor shall comply with the following:

- (1) where the ventilation duct does not form a protected shaft or is not contained within a protecting structure, the duct shall be fitted with a fire damper where it passes through the compartment wall or compartment floor; and
- (2) where the ventilation duct forms a protected shaft or is contained within a protecting structure, the duct shall be fitted with fire dampers at the shaft inlets and outlets.

b. **Installation of fire dampers**

- (1) Fire dampers shall be installed so that the casing completely penetrates through the compartment wall or floor, and the casing shall be retained, either:
 - (a) on both sides by means of flanges in such a manner that it can expand under fire conditions without distorting the blades in the closed position, or
 - (b) on the accessible side by means of one flange only, which can be fixed to the damper and to the wall through slotted holes to allow for expansion.
- (2) Flanges shall be butted against the face of the compartment wall or floor and fixed to the damper casing.
- (3) Ductwork connected to the damper shall be attached in such a manner as to ensure that the damper remains securely in position and is fully functional in the event of damage of ductwork.

- (4) The clearance between the damper body and the sides of the penetration shall not be less than that of the tested prototype and be not greater than half the width of the angled section of the collar.
- (5) The space between the damper body and the opening in the wall or floor shall be fire-stopped.
- (6) Vertically positioned fire dampers shall be installed in such a manner that the direction of air flow assists in the closure of the damper.

(7) Connections to fire dampers

The distance between the plane through a closed fire damper and ducting, flexible connections, duct coverings, internal linings and the like, shall be

- (a) not less than 1m when such parts are made of materials with fusing temperatures less than 1000°C;
- (b) not less than three times the diagonal or diameter of the damper; and
- (c) not less than 2m when such parts are made of materials that are combustible, except for vapour barrier to provide thermal insulation.

(8) Fire damper inspection access doors

Each fire damper installation shall be provided with an inspection access door in the ventilation duct, either upstream or downstream, as appropriate. The access door dimension shall measure 450mm (length) X 450mm (width); for smaller ducts, the door width dimension can be reduced to the width or depth of the duct. Access doors shall be hinged and fitted with sash locks, and be constructed of minimum 1.25mm suitably braced sheet steel. Openings in ducts shall be stiffened by a sheet steel frame.

c. Prohibition of fire dampers

Fire dampers shall not be fitted in any of the following locations:

- (1) openings in walls of a smoke extract shaft, or a return air shaft which also serves as a smoke extract shaft, or
- (2) openings in walls of a protected shaft when the openings have a kitchen exhaust duct passing through it, or
- (3) opening in walls of a protected shaft when the openings have a fume hood exhaust duct passing through it, or
- (4) anywhere in an air pressurising system, or
- (5) in locations explicitly prohibited in this Code.

d. **Standards**

Where a fire damper is required by this Code to be installed in an air-conditioning and mechanical ventilation system, its type, details of installation, connection of accessories, inspection door, etc., shall be in accordance with SS CP 333.

7.1.6 **Fire resisting floor ceiling and roof ceiling**

- a. The space above a suspended ceiling which forms part of a fire-rated floor ceiling or roof ceiling construction shall not contain ducting, unless said ducting was incorporated in a prototype that qualified for the required fire resistance rating, in which case the ducting shall be identical to that incorporated in the tested prototype.
- b. Openings in the ceiling, including openings to enable the ceiling to be used as a plenum, shall be protected by fire dampers identical to those used in the tested prototype. Such openings in the ceiling shall be so arranged that:
 - (1) no opening is greater in area than that in the corresponding prototype test panel;
 - (2) the aggregate area of the openings per unit ceiling area does not exceed that of the prototype test panel; and
 - (3) the proximity of any opening to any structural member is not less than that in the prototype test panel.

7.1.7 **Locations of intakes and return air openings**

- a. Openings for the intakes of outdoor air to all air handling systems, mechanical ventilation systems, pressurisation systems of exit staircases and internal corridors, and smoke control systems shall be no less than 5m from any exhaust discharge openings.
- b. All return air openings and outdoor air intakes shall be located and arranged such that sources of ignition, such as lighted matches and cigarette butts, which accidentally enter the openings and intakes cannot be deposited onto the filter media.

7.1.8 **Air handling unit (AHU) room**

a. **Air plenums**

Air handling systems shall not use protected shafts of exits, smoke-stop lobbies, including its concealed space for supply, exhaust or return air plenums.

b. **Compartmentation**

- (1) Where the air handling equipment serves more than one compartment, fire dampers shall be provided in air ducts at penetrations through the compartment walls and floors to comply with the requirements in *Cl.7.1.5*.

- (2) Where AHU rooms are vertically stacked, each AHU room shall be separated by a compartment floor at every level.

c. Smoke detectors

- (1) Smoke detectors of approved type shall be incorporated in the return air stream immediately adjacent to:
- (a) AHUs serving more than one storey or compartment, or
 - (b) a single AHU in excess of 15000 m³/h.
- (2) The function of smoke detectors, where required by this Code, is to initiate action to shut down the AHU automatically when the smoke density in the return air system has become unacceptable for recycling.

d. Stop switch

Where the AHUs in a building are not centrally controlled, each AHU exceeding 8500m³/h shall be provided with a manual stop switch to facilitate quick shutting down of the fan in the case of fire. For ease of access, this switch shall be located on the wall next to the door opening of the air handling equipment room.

7.1.9 Ventilation system for exits

a. Air plenums

Protected shaft of exits, smoke-stop lobbies, including their concealed spaces shall not be used for supply, exhaust or return air plenum of air handling systems.

b. Exit staircase and internal exit passageway

A mechanical ventilation system for each exit staircase and internal exit passageway, if provided, shall be an independent system of supply mode only exclusive to the particular staircase, and it shall comply with all of the following requirements:

- (1) Supply air for the system shall be drawn directly from the external space, with intake point not less than 5m from any exhaust discharge openings.
- (2) For exit staircase serving more than four storeys, supply air shall be conveyed via a vertical duct extending throughout the staircase height and discharging through outlets distributed at alternate floors.
- (3) Where the supply air duct serving the exit staircase has to penetrate the staircase enclosure, the portion of the duct where it traverses outside the staircase shall be enclosed in masonry construction or drywall complying with *Cl.3.8.7b.* of at least the same fire resistance as the elements of structure, and it shall not be fitted with fire dampers.
- (4) The ventilation system shall be of supply mode only, and of not less than 4 air changes per hour.

- (5) The mechanical ventilation system shall be automatically activated by the building fire alarm system. In addition, a remote manual start-stop switch shall be made available to firefighters at the FCC, or, where there is no FCC, at the fire alarm panel.
- (6) Visual indication of the operational status of the mechanical ventilation system shall be provided.

7.1.10 Ventilation system for smoke-stop lobby and fire lift lobby

- a. The ventilation system shall be of supply mode only of not less than 10 air changes per hour.
- b. Supply air shall be drawn directly from the external space with intake point not less than 5m from any exhaust discharge or openings for natural ventilation.
- c. Any part of the supply duct running outside the smoke-stop or fire lift lobby which it serves shall either be enclosed or constructed to give a 1-hr fire resistance rating. The SCDF may, at its discretion, require a higher fire resistance rating if the duct passes through an area of high fire risk.
- d. The mechanical ventilation system shall be automatically activated by the building fire alarm system. In addition, a remote manual start-stop switch shall be made available to firefighters at the FCC, or, where there is no FCC, at the main fire alarm panel.
- e. Visual indication of the operational status of the mechanical ventilation system shall be provided.

7.1.11 Ventilation system for engine-driven fire pump room and generator room

Where mechanical ventilation is installed to provide a smoke-free environment for the room housing the engine-driven fire pump or emergency generator, such systems shall be independent of each other and of any other system serving other parts of the building, and shall comply with all of the following requirements:

- a. Supply air shall be drawn directly from the external space and its intake point shall not be less than 5m from any exhaust discharge openings. Exhaust discharge shall also be direct to the external space.
- b. Where the corresponding ducts run outside the room they shall either be enclosed in a structure or be constructed to give at least the same fire rating as the room which they serve, or that of the room through which they traverse, whichever is higher. The rating shall apply to fire exposure from both interior and exterior of the duct or structure. Where the duct risers are required to be enclosed in a protected shaft constructed of masonry or drywall complying with *Cl.3.8.7b.*, they shall be compartmented from the rest of the shaft space containing other ducts or service installations.
- c. No fire damper shall be fitted in either supply or exhaust duct required under this clause.

- d. A duct serving areas other than rooms housing equipment stated in this clause shall not pass through such rooms.

7.1.12 Ventilation system for Fire Command Centre (FCC)

The FCC can either be air-conditioned, naturally ventilated or mechanically ventilated. The air-conditioning or mechanical ventilation shall be independent of each other and any other system serving other parts of the building. Where mechanical ventilation is required, it shall also comply with all of the following requirements:

- a. Supply air shall be drawn directly from the external space and its intake point shall not be less than 5m from any exhaust discharge openings. Exhaust discharge shall also be direct to the external space.
- b. Where the corresponding ducts run outside the FCC, they shall either be enclosed in a structure or be constructed to give at least the same fire rating as the room which they serve or that of the room through which they traverse, whichever is higher. Where the duct risers are required to be enclosed in a protected shaft constructed of masonry or drywall complying with *Cl.3.8.7b.*, they shall be compartmented from the rest of the shaft space containing other ducts or service installations.
- c. No fire damper shall be fitted in either supply or exhaust duct required under this Clause.
- d. A duct serving areas other than the FCC shall not pass through the room.

7.1.13 Exhaust system for kitchen

a. Provision

A mechanical exhaust system for the cooking area of a kitchen in a hotel, restaurant, coffee house or the like shall be independent of those serving other parts of the building. It shall also comply with all of the following requirements:

- (1) The hood and ducts for the exhaust shall have a clearance of 500mm from unprotected combustible materials.
- (2) The exhaust shall discharge directly to the external space and shall not be less than 5m from any air intake openings.
- (3) The exhaust duct, where it runs outside the kitchen, shall either be enclosed in a structure or be constructed to give at least the same fire rating as the kitchen or that of the room through which it traverses, whichever is higher. The rating shall apply to fire exposure from both interior and exterior of the duct or structure. Where the duct riser is required to be enclosed in a protected shaft constructed of masonry or drywall complying with *Cl.3.8.7b.*, it shall be compartmented from the rest of the shaft space containing other ducts or services installations.
- (4) No fire damper shall be fitted in kitchen exhaust ducts.

b. Sharing of kitchen exhaust system

Sharing of kitchen exhaust system for food and beverage outlets is allowed, provided all of the following conditions are complied with:

(1) For food courts

- (a) The food court shall be under a single ownership/operator.
- (b) All kitchen exhaust ducts running outside the food court shall have 1-hr fire resistance rating, or shall not be less than that for the elements of structure, whichever is higher.

(2) For restaurants/small F&B outlets (e.g. snack bars, food kiosks, etc.)

- (a) Restaurants and small F&B outlets that are sharing the same kitchen exhaust system shall be located on the same storey and within the aggregate zone area not exceeding 2000m². The maximum length of the aggregate zone covering from the first to the last restaurant/F&B outlet shall not exceed 50m.
- (b) The aggregate floor area of the restaurants and F&B outlets shall not exceed 1000m².
- (c) Common ducts shall be provided with a common exhaust fan.
- (d) The building shall be protected by an automatic fire sprinkler system.
- (e) The exhaust hood shall be fitted with a wet chemical fire extinguishing system.
- (f) The fire rating of the common kitchen exhaust duct running outside the restaurants shall have 1-hr fire resistance rating, or shall not be less than that for the elements of structure, whichever is higher.

(Note: Kitchen exhaust ducts include both horizontal and vertical ducts.)

c. Kitchen exhaust duct

- (1) A kitchen exhaust duct running outside a building shall not be located within 3m of any unprotected openings. This separation distance can be reduced to 1.5m if the unprotected opening is on the same plane as the duct. (See *Diagram 7.1.13c.(1) - 1 and 2*)
- (2) Where the distances mentioned above cannot be achieved, a fire resistant construction having at least ½-hr fire resistance shall be placed between the duct and the unprotected opening. (See *Diagram 7.1.13c.(2)*)
- (3) A non-fire-rated kitchen exhaust duct shall not be located above an LPG storage cabinet, unless they are separated from LPG cylinders by a minimum of 2-hr fire-rated masonry construction above and beside the cylinders. (See *Diagram 7.1.13c.(3)*)

- (4) The kitchen exhaust duct shall be located at least 3m from any unprotected LPG cylinders. Non-fire-rated kitchen exhaust duct shall be located at least 600mm from the vapouriser or any liquid-phase LPG pipeline. (See *Diagram 7.1.13c.(4)*)

d. Maintenance

All kitchen exhaust systems shall be properly maintained. The entire (interior and exterior) exhaust duct and kitchen hood shall be degreased and cleaned at least once every 12 months. The work shall be carried out by a specialist and the records of cleaning and degreasing shall be kept by the owner/operator for verification by the authority having jurisdiction. This requirement shall be included in the Fire Safety Instruction Manual

7.1.14 Ventilation system for rooms involving use of flammable and explosive substances

a. Dedicated system

Mechanical ventilation systems, where required for rooms which involve the use of flammable and explosive substances, shall be independent from those serving other parts of the building. They shall comply with all of the following requirements:

- (1) Ventilation system shall consist of exhaust and supply parts with a rate of 20 air changes per hour or any other rates acceptable to the SCDF. The exhaust shall direct to the external space and shall not be less than 5m from any air intake openings.
- (2) Where such ducts run outside the room they shall either be enclosed in a structure or be constructed to give at least the same fire rating as the room which they serve or that of the room through which they traverse, whichever is higher. The rating shall apply to fire exposure from both interior and exterior of the duct or structure. Where the duct risers are required to be enclosed in a protected shaft constructed of masonry or drywall complying with *Cl.3.8.7b.*, they shall be compartmented from the rest of the shaft space containing other ducts or service installations.
- (3) No fire damper shall be fitted in either a supply or exhaust duct required under this Clause.
- (4) Ducts serving other areas shall not pass through rooms involving use of flammable and explosive substances.

b. Sharing of supply air duct

A common fire-rated supply air duct can serve various compartments within the same floor level or other floor levels, provided:

- (1) the compartments are sprinkler-protected;
- (2) the compartments are of the same purpose group;

- (3) the duct is fitted with a fire damper where it passes through the wall or floor of each fire compartment; and
- (4) a dedicated exhaust duct is provided for individual fire compartments and shall be maintained in operation (with the minimum flow rate) even it is under fire mode situation to prevent smoke entering into other fire compartments.

7.1.15 Ventilation system for rooms housing batteries

Rooms housing batteries shall comply with the following requirements:

- a. The batteries shall be of either vented or sealed type.
- b. The room ventilation system shall be designed to limit the maximum concentration of Hydrogen (H_2) gas to 1% of the total volume of the room during the worst case event of simultaneous “boost” charging of the batteries. The inlets and outlets of the ventilation system shall be properly located so that there is no stagnant area in the room.
- c. Adequate hydrogen gas detectors shall be provided inside the room to monitor the hydrogen concentration and to activate the fan, if necessary, to ensure that the hydrogen concentration level at any part of the room does not exceed 1% of the total volume of the room. Display panels showing the readings of the detectors shall be located at the entrance to the room. At the same time, an alarm signal shall be sent to a manned station such as security control room, guard house or FCC.
- d. The design of the battery room ventilation shall be in accordance with BS EN IEC 62485-2 & BS EN IEC 62485-3.
- e. For mechanically ventilated battery rooms, the ventilation requirement shall be based on *Cl.7.1.15d.*, or 6 air changes per hour, whichever is higher.
- f. No fire damper shall be provided in the essential ventilation system and ducts passing through other compartments shall have 2-hr fire resistance rating.
- g. Essential fans and associated electrical controls shall be backed up with a secondary source of power supply.

7.2 PRESSURISATION FOR EXIT STAIRCASES

7.2.1 Provision

a. Internal exit staircase

In any building of which the habitable height exceeds 24m, any internal exit staircases without adequate provision for natural ventilation shall be pressurised to comply with the requirements in this Code. Where the upper part of the staircase is naturally ventilated, its lower part can be provided with mechanical ventilation or pressurisation, whichever is appropriate, in

accordance with *Cl.2.3.3d.(9)*.

b. Basement

In a building comprising more than four basement storeys, exit staircases connected to a fire lift lobby in basement storeys shall be pressurised to comply with the requirements in this Code.

c. PG II occupancy

Where PG II building is provided with a mechanical ventilation system or pressurisation system for its staircase storey shelter, an automatic smoke detection system complying with SS CP 10 shall be installed. The smoke detector shall be located at the entrance of each exit staircase at every storey, including the non-residential floors. Activation of any smoke detector shall initiate the operation of the mechanical ventilation system or pressurisation system.

7.2.2 Pressurisation level

- a. When in operation, the pressurisation system shall maintain a pressure differential of not less than 50 Pa between the pressurised exit staircase and the occupied area when all doors are closed.
- b. Where a smoke-stop lobby is also pressurised, the pressure at the exit staircase shall always be higher.
- c. The force required to open any door against the combined resistance of the pressurising air and the automatic door closing mechanism shall not exceed 110N at the door handle.

7.2.3 Egress velocity

- a. When in operation, the pressurisation system shall maintain an airflow of sufficient velocity through open doors to prevent smoke from entering into the pressurised area.
- b. The flow velocity shall be attained when a combination of two doors from any two successive storeys and the main discharge door are fully open.
- c. The velocity averaged over the full area of each door opening shall not be less than 1.0 m/s.

7.2.4 Leakages

- a. The rate of supply of pressurised air to the pressurised areas shall be sufficient to make up for loss through leakages into the unpressurised surroundings.
- b. Adequate relief of leaked air out of the occupied area shall be provided to avoid a pressure build-up in this area. The relief can be in the form of perimeter leakages or purpose built extraction systems.

7.2.5 Distribution of pressurising air

- a. The number and distribution of injection points for supply of pressurising air to the exit staircase should ensure an even pressure profile complying with *Cl.7.2.2*.
- b. The arrangement of the injection points and the control of the pressurisation system shall be such that when the opening of doors or other factors cause significant variations in pressure difference, the condition in *Cl.7.2.2* shall be restored as soon as practicable.

7.2.6 Pressurisation equipment and controls

- a. All the equipment and the relevant controls associated with the pressurisation system shall be designed and installed to ensure satisfactory operation in the event of a fire.
- b. Supply air for the pressurisation system shall be drawn directly from the external space and its intake shall not be less than 5m from any exhaust discharge openings.
- c. The pressurisation system shall be automatically activated by the building fire alarm system. In addition, a remote manual start-stop switch shall be made available to firefighters at the FCC, or at the fire alarm panel where there is no FCC. Visual indication of the operation status of the pressurisation system shall be provided.

7.3 PRESSURISATION OF INTERNAL CORRIDORS IN HOTELS

7.3.1 Pressure differences

- a. Where internal corridors in hotels are required to be pressurised in compliance with *Cl.9.7.2a.(3)*, the pressure within such corridors shall be higher than that in the guest rooms by 12.5 Pa. Corridor pressurisation shall be activated for the floor on fire and two floors above.
- b. The pressure within the smoke-stop lobby/fire lift lobby serving these internal corridors shall be higher than that of the internal corridors by 12.5 Pa. The pressurisation fans serving the smoke-stop lobby/fire lift lobby shall activate on all floors during a fire.
- c. Pressure within the internal exit staircases shall comply with *Cl.7.2.2a*.

7.4 SMOKE CONTROL SYSTEM

7.4.1 Provision

- a. An engineered smoke control system as specified in *Cl.7.4.5* shall be provided where:

- (1) the requirements for compartmentation specified in *Cl.3.2.1*, *Cl.3.2.4a* and *Cl.3.2.4b* are relaxed under the conditions in *Cl.3.2.6* for Atrium spaces in a building, or
 - (2) the total floor area of any compartment in a building or part of a building exceeds 5000m², or
 - (3) the total aggregate floor area of all basement storeys exceeds 2000m², except in any of the following situations:
 - (a) Where the basement or a portion of the basement is used as a car park, the car park shall comply with the requirements of *Cl.7.4.3*, provided it is compartmented from the rest of the basement.
 - (b) Where a plant/equipment room with floor area not exceeding 250m² is compartmented from rest of the basement, two doors remotely located from each other for better reach in firefighting operations shall be provided. The provision of a single door opening for this room is permitted provided the most remote part of the room is less than 8m from the door, and the equipment found inside this room, does not obstruct the throw of a water jet from a firefighting hose.
 - (c) Where a plant/equipment room with floor area exceeds 250m² but not 2000m², and for which smoke vents in accordance with *Cl.7.4.2* or smoke purging system of at least 9 air changes per hour are provided.
 - (d) Where a service area comprising storerooms or workshops (restricted to staff only) which are compartmented, which are provided with smoke venting in accordance with *Cl.7.4.2*, or a smoke purging system of at least 9 air changes per hour in lieu of an engineered smoke control system. An automatic fire alarm/ extinguishing system in accordance with *Table 6.4A* shall be provided where required.
- b. A smoke vent in accordance with *Cl.7.4.2* shall be provided if the total aggregate floor area of all basement storeys does not exceed 2000m². In lieu of smoke vents, a smoke purging system or an engineered smoke control system is permissible for car parks or other occupancies respectively.

7.4.2 Smoke vent

Smoke vents shall be adequately distributed along the perimeter of the space served, and its outlets shall be easily accessible during firefighting and rescue operations. Smoke vents shall comply with the following requirements:

- a. the number and their sizes shall be such that the aggregate effective vent openings shall not be less than 2.5% of the floor area served;
- b. the vent outlets, if covered under normal conditions, shall be openable in case of fire;

- c. the position of all vent outlets and the areas they serve shall be suitably indicated adjacent to such outlets;
- d. where ducts are required to connect the vent to outlets, the ducts shall either be enclosed in structure or be constructed to give at least 1-hr fire resistance rating; and
- e. separate ducts and vent outlets shall be provided for each storey.

7.4.3 Smoke purging system

Smoke purging system, where permitted under this Code in buildings, shall conform to all of the following requirements:

- a. The smoke purging system shall be independent of any other system serving other parts of the building.
- b. The purging system's purge rate shall be at least 9 air changes per hour.
- c. The purging system shall be activated automatically by the building fire alarm system. In addition, a remote manual start-stop switch shall be located at the FCC, or at main fire alarm panel on first storey (where there is no FCC in the building). Visual indication of the operation status of the smoke purging system shall also be provided with this remote control.
- d. Supply air shall be drawn directly from the external space and its intake shall not be less than 5m from any exhaust discharge openings. Outlets for the supply air shall be adequately distributed over the area served.
- e. Where there is natural ventilation for the area served based upon evenly distributed openings equal to not less than 2.5% of the floor area of a given storey, such natural ventilation can be considered a satisfactory substitute for the supply part of the smoke purging system.
- f. Replacement air shall be provided and if it is supplied by a separate mechanical system, such a system shall be connected to a secondary power supply.
- g. Exhaust ducts shall be fabricated from heavy gauge steel of at least 1.2mm thickness.
- h. The exhaust fan shall be capable of operating effectively at 250°C for 2 hours and be connected to a secondary power supply.

7.4.4 Ductless jet fan system

a. General

This system can be used in lieu of a smoke purging system for conventional car parks where passenger cars/light weight vehicles are parked alongside each other with common driveways. It is not intended for mechanised car park systems or other forms of car parking systems.

b. Provision of sprinkler system

- (1) The basement car park shall be sprinkler-protected in accordance with the SS CP 52.
- (2) The arrangement of the sprinkler heads and the jet fans shall be such that, upon the operation of the jet fans, the effect on the spray pattern of the sprinklers is minimised.

c. Zoning of car park

- (1) All car park spaces shall be divided into smoke control zones with each zone not larger than 2000m² (excluding plant rooms and circulation spaces) for the purpose of smoke containment and quicker location of fire. A commissioning test will be carried out using hot smoke to demonstrate that smoke can be contained within each zone and channelled to the extract fans.
- (2) Each smoke control zone shall have its own jet fan system (fresh air fans, exhaust air fans and jet fans) to purge smoke from the affected zone. The ducts shall be fabricated from heavy steel gauge steel of 1.2mm thickness. Alternatively, sharing of the fresh air and exhaust air fans is permitted provided the fans, wiring and control panel are protected with at least 1-hr fire resistance rating. The exhaust fan system shall also be designed to run in at least two parts, such that the total exhaust capacity does not fall below 100% of the required rate of extract for the zones affected in the event of failure of any one part. This requirement is also applicable for mechanised supply fan system, if it is used.

d. Jet fan system

- (1) The jet fan system shall be activated by the sprinkler system serving the basement car park level and any other areas located within the same level. The activation of the jet fan system shall be confined to the smoke control zone on fire and all its adjacent zones. A firefighter cut-off and activation (override) switch shall be provided at the FCC. As an alternative form of fan activation, the use of smoke detectors to activate the jet fan system is allowed, provided:
 - (a) the detectors are positioned at the effective mid-range of the jet fan profile;
 - (b) in-duct smoke detector is located at the start point of the exhaust duct; and
 - (c) jet fan system shall only operate upon activation of two smoke detectors. This is to minimise false alarms.
- (2) The jet fan system shall be provided with a secondary source of power supply through automatic operation of an emergency generator in case of failure of the primary power supply source.
- (3) The jet fans shall be distributed at a spacing of $\frac{2}{3}$ of the tested

effective range of each jet fan. The tested effective range of the jet fan shall be taken as the distance up to the point at 0.2m/s of the air-velocity distribution profile.

- (4) The minimum headroom for the installation of jet fan system is 3m.
- (5) The interaction of the various components of the jet fan system shall be as follows:
 - (a) Each group of exhaust fans for each smoke control zone shall be interlocked with its corresponding groups of jet fans for that zone.
 - (b) If the group of exhaust fans stops/fails in any smoke control zone, the corresponding group of jet fans in that zone shall stop. But if any of the exhaust fans is still in operation in a particular smoke control zone, all the jet fans in that zone shall continue to operate.
 - (c) The exhaust fan shall continue to run even if any corresponding group of jet fans fails.
 - (d) The other groups of jet fans shall continue to run even if any one group of jet fans fails.
 - (e) If the fire alarm signal is isolated, the exhaust fans and jet fans shall continue to run at high speed. If the fans are manually restarted, both the exhaust fans and jet fans shall continue to run at high speed until they are set to low speed at the field control panel.
- (6) The jet fan system shall be independent of any systems serving other parts of the building.
- (7) The jet fan system design shall be such that the bulk air velocity induced by the jet fans is sufficient to stop the advance of the ceiling jet within 5m from the fire location in the direction opposite to the induced bulk air flow.
- (8) The smoke control sub-panel in each smoke control zone is to be connected to the main smoke control panel, such that any isolation of jet fan system at a particular zone is automatically displayed at the main smoke control panel.
- (9) The car park main smoke control panel at the FCC/Guard house and remote local panel for the supply and exhaust fans shall indicate, by means of indicator lights, whether the fans are on low or high speed. The panels are also required to have the individual group of jet fans indication lights interlocked with the main exhaust fans in the respective smoke control zones.
- (10) In the event of failure of the primary source of power supply and subsequent operation of the secondary power supply, the mode of operation of the jet fan system during the fire mode shall follow that prior to the failure of the primary power supply. For example, if the operation

of jet fan system in a particular smoke control zone is switched off by the firefighter during fire mode condition and the primary source of power fails, the subsequent operation of the secondary power supply shall be such that the jet fan system remains in the previous fire mode condition, i.e. non-operational mode for that smoke control zone, while the other smoke control zones resume operation.

- (11) The jet fan system design shall take into consideration the presence of any down-stand beams and other obstructions that are of depths of more than $\frac{1}{10}$ of the car park floor to ceiling height so as to account for any resistance to airflow.
- (12) On activation of the jet fan system, the movement of smoke towards the extraction point(s) shall not adversely affect the means of escape and cause smoke to be blown into the lobby area or exit staircases.
- (13) The operation of the jet fan system should be such that there are no stagnant areas where smoke can accumulate in the event of fire.
- (14) The operation of the jet fan system shall not cause the volume of air movement to be greater than that volume extracted by the main exhaust fans.

e. Wiring arrangement of jet fans

- (1) All jet fans shall be connected to the local jet fan control panel in groups of not more than three jet fans.
- (2) Each group will be connected by fire-rated cabling.
- (3) Each group of jet fans will be protected by a separate MCB (main circuit breaker), with power supply compliant with SS CP 5, to prevent the failure of all the jet fans at once due to tripping of the main RCB, e.g. due to overloading.
- (4) The jet fans shall also be wired in a zigzag configuration and no two consecutive jet fans in a straight line are to be wired in the same group. In the event of failure of one group of jet fans, the next corresponding group will be able to drive the smoke towards the exhaust location to be extracted (see *Diagram 7.4.4e.(4) - 1 & 2*). Should one group of jet fans fail, all other groups shall still continue to run.
- (5) The location of the local control panel for the operation of the jet fans within each zone shall be in a relatively safe area within the zone and be spaced as least 5m apart from the local control panels of adjacent zones. This is to minimise the risk of a fire affecting all the control panels if they be spaced closely together, and thus rendering the ineffectiveness of the jet fan system.

f. Provision of supply air

- (1) Supply air to the car park can be provided via mechanised supply air fans or by permanent openings of at least 2.5% of the floor area.

Whichever is used, the maximum inlet air speed should be 2m/s to prevent recirculation of smoke.

- (2) The air velocity within escape routes and ramps shall not exceed 5m/s to prevent escapees from being hindered by the air flow.
- (3) The replacement air intakes shall face away from any smoke exhaust points and be sited at least 5m apart so as to prevent recirculation of smoke. If the supply and exhaust louvers are located on the same façade of the building, they shall also be sited at least 5m apart.
- (4) The replacement air intake shall be located on the opposing end of the smoke exhaust points so that there is no opposing flow between the supply air and the smoke that is drawn towards the exhaust fan.

g. Exhaust fan design

- (1) The car park shall be provided with at least 12 air changes per hour during a fire.
- (2) The capacity of the exhaust fan and any associated ducting shall be calculated on the basis that the pressure in the car park close to the extract points is equal to the external atmospheric pressure.
- (3) Each smoke control zone of the car park shall have its own exhaust fan system. The exhaust fan system in each zone should be designed to run in at least two parts, such that the total exhaust capacity does not fall below 50% of the required rate of extract in the event of failure of any one part, and that a fault or failure of the exhaust fan system in one zone will not affect the operation of the exhaust fan system in the other zones. The above requirement is also applicable for mechanised supply fan systems, where used. (Note: If there is sharing of the exhaust air fans, see [Cl.7.4.4c.\(2\)](#))
- (4) The smoke discharge points shall be located such that the smoke extracted from the smoke exhaust fans does not affect any occupied area or means of escape at the level where smoke is discharged.

h. Fire resistance of jet fan system

The jet fan system, such as the mechanised air supply fans, smoke exhaust fans, jet fans, duct works and wiring shall be capable of operating effectively at 250°C for 2 hours. The fans, ducts and wiring shall be tested in accordance with BS 7346: Pt 2, BS 476: Pt 24 and SS 299 respectively.

7.4.5 Engineered smoke control system

a. Acceptable design guidance

The engineered smoke control system shall be in the form of a smoke ventilation system by natural or mechanical extraction designed in accordance with BR 186, BR 258, BR 368 and other acceptable standards:

b. Sprinkler system

A building provided with an engineered smoke control system shall be sprinkler-protected.

c. Fire size

(1) Non-industrial buildings

The capacity of the engineered smoke control system shall be calculated based on the incidence of a likely maximum fire size for a sprinkler controlled fire as recommended in the following table:

TABLE 7.4.5C.(1) : FIRE SIZE FOR NON-INDUSTRIAL BUILDINGS		
Occupancy (Sprinkler-protected)	Fire Size	
	Heat Output (MW)	Perimeter of Fire (m)
Shops	5	12
Offices	1	14
Hotel Guest Room	0.5	6
Hotel Public Areas	2.5	12
Assembly Occupancy with Fixed Seating	2.5	12

(2) Industrial buildings

The requirements for design fire size are applicable to sprinkler-protected industrial premises (factory and warehouse) without in-rack sprinklers and limited to the design of smoke control system based on [Cl.7.4](#).

(a) Fire growth

The fire growth can be evaluated by the following generic fire growth curve (also referred to as 't² fire'), that represents the general types of combustible material present within an enclosure:

$$Q_{max} = \alpha (t-t_i)^2 \text{ ----- equation (1)}$$

where:

Q_{max} = heat release rate (kW);

α = fire growth parameter (kJ/s³);

t = time (s);

t_i = time of ignition (s) (taken here as zero)

The fire growth parameter varies with the fire load density and the fire load configuration factor. However, for purpose of design, fire growth parameter can be generally defined as follows:

TABLE 7.4.5C.(2)(A) : FIRE GROWTH PARAMETER FOR INDUSTRIAL BUILDINGS		
Fire growth rate	Fire growth parameter (kJ/s ³)	Time for Q _g = 1MW (s)
Slow	0.0029	600
Medium	0.012	300
Fast	0.047	150
Ultra fast	0.188	75

Note:
The fire growth rate that is applicable through available literature or standard such as the SFPE Handbook shall be adopted. In the instance where the fire growth rate lies in between the range as stated above, the more conservative fire growth rate is to be used.

(b) Design fire – sprinkler-protected

- (i) The heat output of the design fire is assumed to increase according to equation (1) until sprinkler operation is deemed to occur at time t_s . Following sprinkler operation, the heat output of the fire is considered to remain constant.
- (ii) The capacity of the smoke control system shall be based on the fire size that is controlled by activation of 2nd ring of sprinklers.
- (iii) The operation of the sprinkler system at t_s and the corresponding fire size can be determined by hand calculations based on fire engineering principles or the use of fire engineering tools such as FPETool from National Institute of Standards and Technology (NIST). Whichever approach is used, the following design factors governing its calculation are as follows:

- Rate of fire growth
The type of fuel load and its configuration in the premises shall govern the rate of fire growth which can be represented using equation (1) and Table 7.4.5c.(2)(a).

- Sprinkler response time index (RTI)
The RTI is the thermal sensitivity of the sprinkler and shall be based on the manufacturer’s specification.

Example:

Standard response sprinkler – $105m^{0.5}s^{0.5}$;

Fast response sprinkler - $50m^{0.5}s^{0.5}$;

ESFR - $26m^{0.5}s^{0.5}$

- **Temperature rating of sprinkler**
The operating temperature of the sprinklers shall be based on SS CP 52 (e.g. 141°C or 68°C).
- **Ambient temperature**
Room temperature for air-conditioned spaces and non-air conditioned spaces can be taken as 25°C and 30°C respectively.
- **Ceiling height**
The ceiling height shall be based on the height, measured from the finished floor level to the soffit of the ceiling/roof.
- **Spacing of sprinkler above fire**
Sprinkler spacing shall be based on SS CP 52 (e.g. 3m by 3m or 4m x 3m).

Note: The application of FPETool from NIST or any other software in determining the activation time of the sprinkler system and the corresponding fire size has its limitations. Some of the software programs are based on Alpert's correlations where a number of fundamental assumptions are made such as flat smooth ceilings, unconfined smoke flow, axisymmetric plumes (not near walls or corners), location of detector close to the ceiling, etc.. Such assumptions shall thus be taken into consideration when using this tool.

- (iv) The capacity of the smoke control system shall also take into consideration the possibility of forklift or general goods vehicle on fire along the internal ramps/driveways. For design purposes, the design fire size shall be taken as follows:

TABLE 7.4.5C.(2)(b)(iv) : VEHICLE DESIGN FIRE SIZE	
Type of vehicle	Design fire size
Forklift or car	4MW
General goods vehicle	10MW

(c) Determination of perimeter of fire

- (i) **Fire perimeter for forklift/car and good vehicle**

The fire perimeter is used to determine the mass flow rate of smoke. For forklift or general goods vehicle, the perimeter of fire shall be taken as follows:

TABLE 7.4.5C.(2)(C)(I) - FIRE PERIMETER SIZE	
Type of vehicle	Perimeter of fire
Forklift or car	5m x 2m
General goods vehicle	9m x 2.5m

- (ii) Fire perimeter other than for forklift/car and general goods vehicle

Other than for forklift/car and general goods vehicle, the following equation is used to calculate the fire perimeter for a square fire of equal sides:

$$P = 4(Q_c/Q_r)^{0.5} \text{ ----- equation (2)}$$

where:

P = fire perimeter (m);

Q_c = convective heat output = $0.7Q_{max}$ (kW);

Q_r = heat release rate per unit area (kW/m²), see Table 7.4.5c.(2)(c)(ii)

Where elongated storage configurations such as racking or shelving are used, the fire perimeter is determined using the following equation:

$$P = 2[Q_c/(Q_r \times d)] \text{ ----- equation (3)}$$

where:

Q_c = convective heat output = $0.7Q_{max}$ (kW);

Q_r = heat release rate per unit area (kW/m²), see Table 7.4.5c.(2)(c)(ii)

d = depth of rack (m)

For purpose of calculating the fire perimeter, the values for Q_r given in Table 7.4.5c.(2)(c)(ii) are used.

TABLE 7.4.5C.(2)(C)(II) - HEAT RELEASE RATE	
Building Use	Heat release rate per unit area, Q_r (kW/m ²)
Industrial	260
Storage	500

d. Capacity

The capacity of an engineered smoke control system shall be capable of

handling the demand for smoke exhaust in a worst case scenario.

e. Clear layer

The design smoke layer base shall be above the heads of people escaping beneath it. The minimum height shall be 2.5m.

f. Smoke reservoir

(1) Smoke reservoirs to prevent the lateral spread of smoke, and to collect smoke for removal, shall be of non-combustible construction capable of withstanding smoke temperatures.

(2) For cases where smoke is removed from the room of origin, the smoke reservoir size for a smoke ventilation system shall not exceed:

(a) 2000m² for a natural smoke ventilation system; and

(b) 2600m² for a mechanical smoke ventilation system.

(3) For cases where smoke is removed from a circulation space or atrium space, the smoke reservoir size for a smoke ventilation system shall not exceed:

(a) 1000m² for a natural smoke ventilation system; and

(b) 1300m² for a mechanical smoke ventilation system.

(4) Reservoir length

The maximum length of the smoke reservoir shall not exceed 60m.

(5) Stagnant regions

Adequate arrangement(s) shall be made in each smoke reservoir for the removal of smoke in a way that will prevent the formation of stagnant regions.

(6) Perforated ceiling

For cases where the smoke reservoir is above the false ceiling, the ceiling shall be of perforated type with at least 25% opening.

g. Discharge of smoke

For cases where smoke is removed from a circulation space or atrium space, the rooms discharging smoke into the circulation space/atrium spaces shall either:

(1) have a floor area of not exceeding 1000m² (for natural ventilation system) or 1300m² (for mechanical ventilation system), or

(2) be subdivided such that smoke is vented to the circulation space or atrium only from part of the room with floor area not exceeding 1000m² (for natural ventilation system) or 1300m² (for mechanical ventilation system), that is adjacent to the circulation space or atrium. However, the remainder of the room needs to be provided with an independent smoke

ventilation system(s).

h. Limitations

Owing to practical limitations, a smoke ventilation system shall have:

- (1) a maximum mass flow not exceeding 175kg/s; and
- (2) a minimum smoke layer temperature of 18°C above ambient temperature.

i. Replacement air

- (1) Replacement air shall by natural means be drawn directly from the external space.
- (2) The design replacement air discharge velocity shall not exceed 5m/s to prevent the escapees being hindered by the air flow.
- (3) Replacement air intake shall be sited at least 5m away from any exhaust air discharge.
- (4) Replacement air shall be discharged at a low level, at least 1.5m beneath the designed smoke layer, to prevent fogging up of the lower clear zone.
- (5) Where the inlet cannot be sited at least 1.5m below the smoke layer, a smoke curtain or a barrier shall be used to prevent replacement air disrupting the smoke layer.
- (6) Where replacement air is taken through inlet air ventilators or doorways, devices shall be incorporated to automatically open such inlet ventilators and doors to admit replacement air upon activation of the smoke ventilation system.
- (7) Where the automatic roller shutters are used at replacement air inlets in the design and installation of an engineered smoke control system, it shall be of perforated type having the required effective free area for the effective operation of the engineered smoke control system.

j. Emergency power supply

The engineered smoke ventilation system shall be provided with secondary source of power supply.

k. Mode of activation

(1) Automatic activation

- (a) The engineered smoke ventilation system shall be activated by smoke detectors located in the smoke control zone. Use of smoke detectors for activation shall be carefully designed, so that accidental or premature activation of smoke detectors in a non-fire zone (due to smoke spills or spread from other areas) are avoided.
- (b) Provision of activating smoke detectors shall comply with SS CP 10.

(2) Manual activation

A remote manual activation and control switches, as well as visual indication of the operation status of the smoke ventilation system, shall also be provided at the FCC. Where there is no FCC, it shall be indicated at the main fire alarm panel.

l. Interlocking with other ACMV systems

Except for ventilation systems in *Cl.5.2.1g.* and *Cl.5.2.1h.*, all other air-conditioning and mechanical ventilation systems within the areas served shall be shut down automatically upon activation of the smoke ventilation system.

m. Standby fans/ multiple fans

(1) Either a standby fan or multiple fans with excess capacity shall be provided for each mechanical smoke ventilation system, such that in the event the duty fan or the largest capacity fan fails, the required smoke extraction rate will still be met. The standby fan shall be automatically activated in the event the duty fan fails.

(2) Fans shall be capable of operating at 250°C for 2 hours.

(3) Protected circuits

The fans and associated smoke control equipment shall be wired in protected circuits designed to ensure continued operation in the event of fire.

(4) Electrical supply

The electrical supply to the fans shall, in each case, be connected to a sub-main circuit exclusive thereto after the main isolator of the building. The cables shall be of at least 1-hr fire resistance rating in accordance with SS 299.

n. Smoke ventilation ducts

(1) Smoke ventilation ducts (both exhaust and replacement air ducts) shall be of at least 1-hr fire resistance rating. The rating shall apply to fire exposure from both the interior and exterior of the duct or structure and the duct shall also comply with *Cl.7.1.2h.*

(2) Where a duct passes through another fire compartment with higher fire rating, the duct shall be constructed to have fire-rating as that of the compartment. Where a duct is installed in a single fire compartment and does not pass through another compartment, smoke control ducts (both exhaust and replacement air ducts) within that compartment need not comply with the 1-hr fire resistance rating requirement subject to the following conditions:

(a) the smoke ventilation ducts (both exhaust and replacement air ducts) are constructed of at least 1.2mm thick galvanised steel sheet;

- (b) sprinklers, designed to SS CP 52, shall be provided above and below the entire length of the ducts (regardless of the duct dimensions) to protect the duct surfaces from the effect of water spray through the activated sprinklers; and
- (c) the construction and support of the duct shall conform to the appropriate requirements of the duct construction standards contained in ASHRAE Handbook, IHVE Guild books or SMACNA Manuals.

o. Fire damper

- (1) Fire dampers shall not be fitted in the smoke ventilation system, except where used in an engineered smoke control system. In such a situation, a combination of fire and smoke dampers shall be constructed in accordance with SS 333, and its electric actuator shall be tested in accordance with the requirements of UL 555S for at least 2 hours at 250°C.
- (2) The damper shall be in closed position during fail-safe mode.
- (3) The combination fire and smoke damper, and any duct extension between it and the protected vent shaft, shall be of the same rating as the element of structure.
- (4) Sprinkler protection shall be provided to the electric actuator.
- (5) The electrical power supply cables to the electric actuator shall be fire resistant.

- p. The time taken for a smoke ventilation system within a smoke zone to be fully operational shall not exceed 60 secs from the time of activation.

q. Fail-safe system

For natural smoke ventilation system, the natural ventilators shall be-

- (1) in the “open” position in the event of power/system failure; and
- (2) positioned such that they will not be adversely affected by positive wind pressure.

- r. Natural ventilation shall not be used together with mechanical ventilation.

s. Smoke curtain

All smoke curtains, where required, unless permanently fixed in-position, shall be brought into position automatically to provide adequate smoke-tightness and effective depth.

t. Obstruction to means of escape

A smoke curtain, or other smoke barrier, located at any access route forming part of or leading to a means of escape, shall not in its operational position obstruct said escape route.

u. **Smoke or channelling screens**

Where glass walls or panels are being used as smoke screens to form a smoke reservoir or as channelling screens, they shall be able to withstand the design highest temperature.

- v. All smoke control equipment (including smoke curtains) shall be supplied and installed in accordance with BS EN 12101-1, BS EN 12101-3 and BS 7346 Pt 7 or equivalent.

7.5 REDUNDANCY FOR MECHANICAL VENTILATION AND PRESSURISATION SYSTEMS

7.5.1 Provision

The fan and its associated controller for the following systems shall be provided with redundancy such that the system performance is not affected when one of the fans and/or controllers is out of operation due to routine maintenance or breakdown:

- a. mechanical ventilation systems for:
 - (1) smoke-stop/fire lift lobbies;
 - (2) exit staircases; and
 - (3) essential rooms (e.g. sprinkler/wet riser/hydrant/hose reel pump room, standby generator room, FCC, etc.).
- b. engineered smoke control systems;
- c. car park smoke purging systems; and
- d. pressurisation systems for smoke-stop/fire lift lobbies, exit staircase and hotel internal corridor.

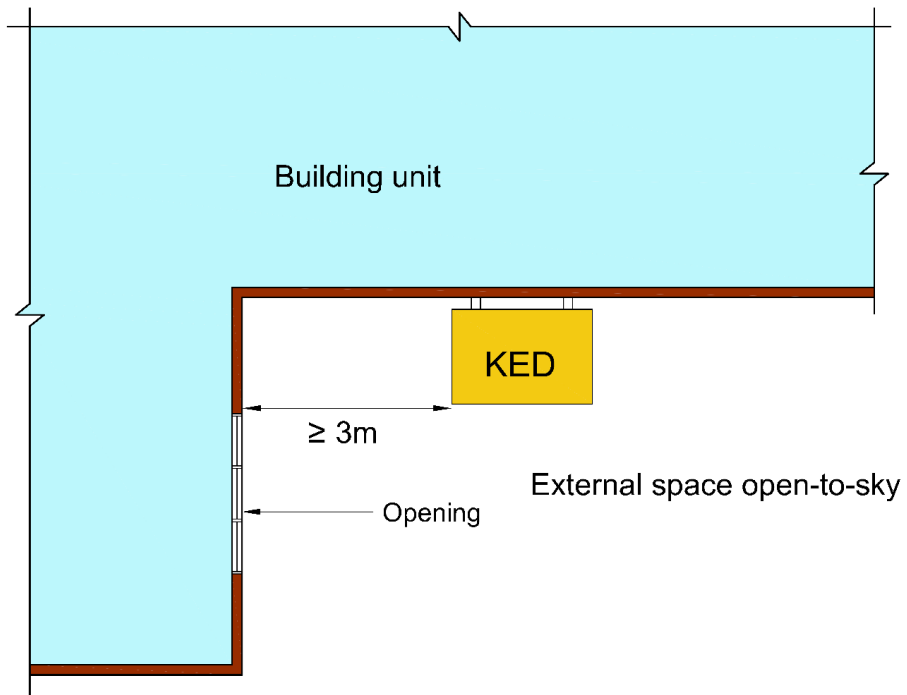

[Diagram 7.1.13c.\(1\) - 1 : Unprotected opening perpendicular to the kitchen exhaust duct](#)

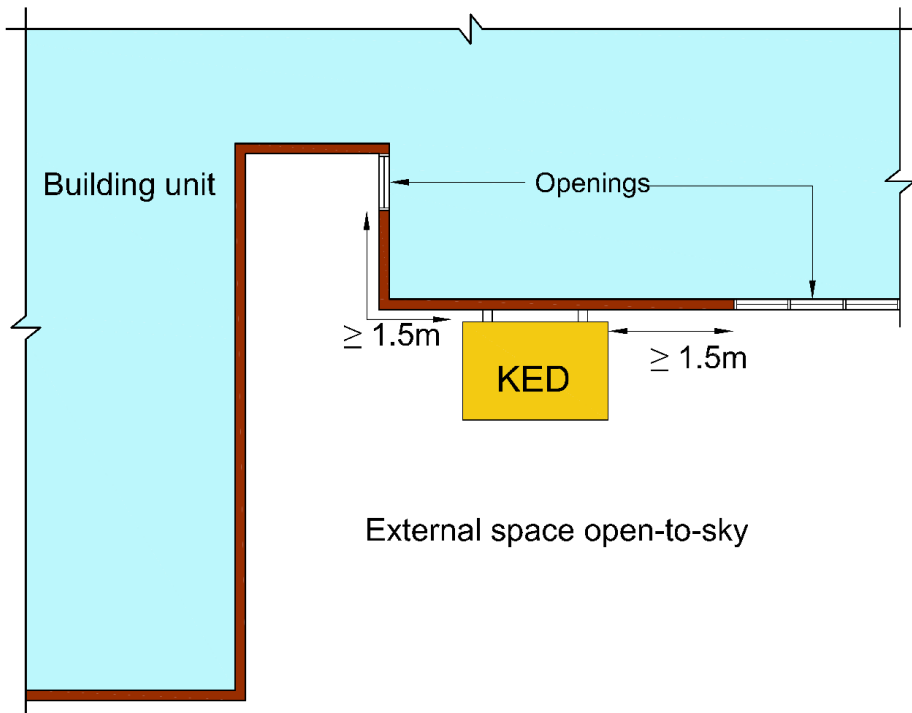

[Diagram 7.1.13c.\(1\) - 2 : Unprotected opening parallel to the kitchen exhaust duct](#)

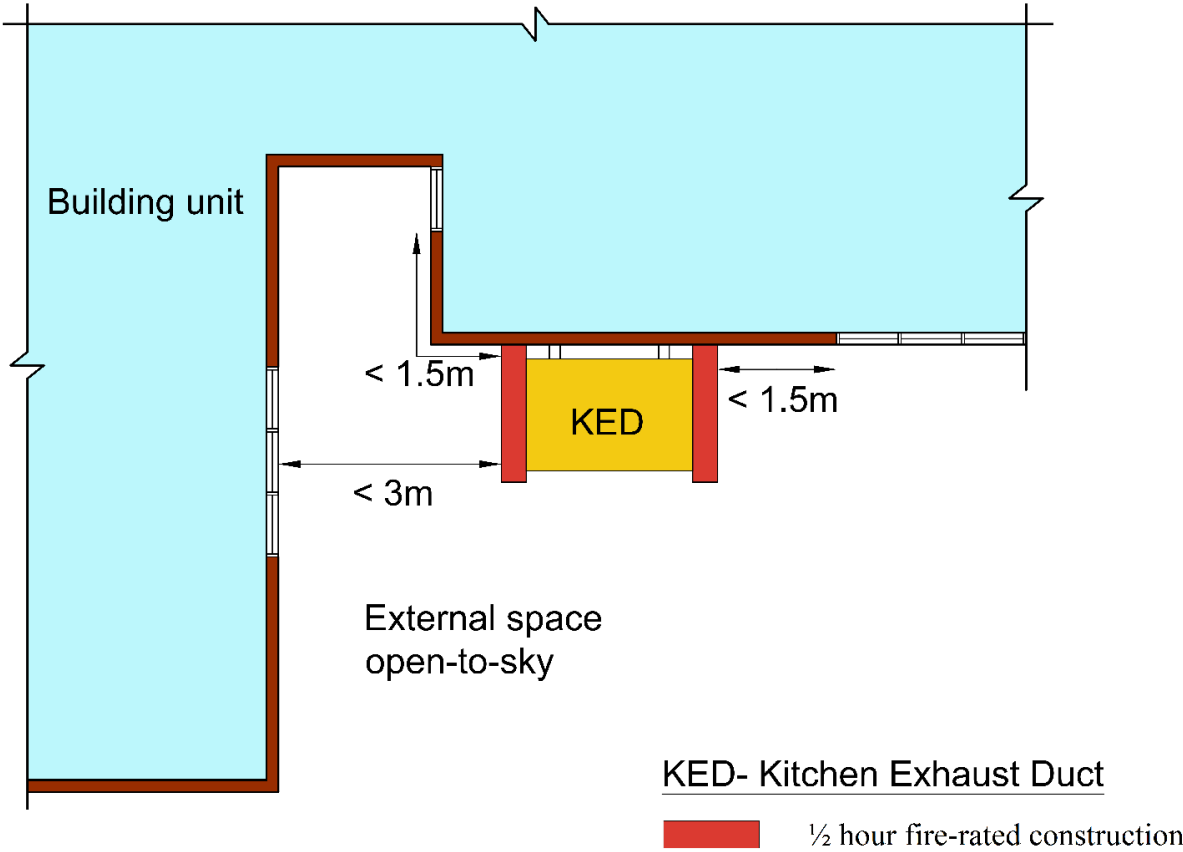

[Diagram 7.1.13c.\(2\) : Fire resistance construction for kitchen exhaust duct](#)

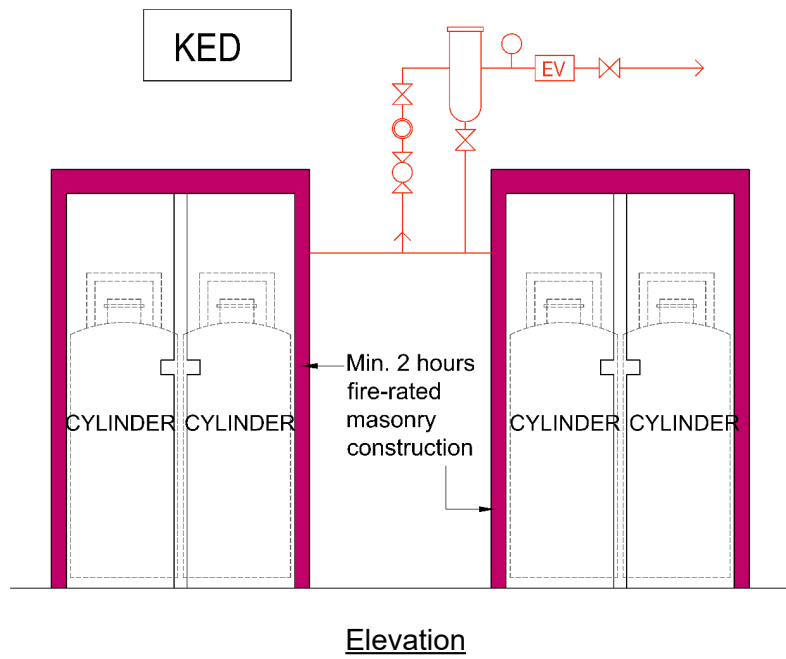

[Diagram 7.1.13c.\(3\) : Installation of non-fire-rated kitchen exhaust duct above LPG cylinders](#)

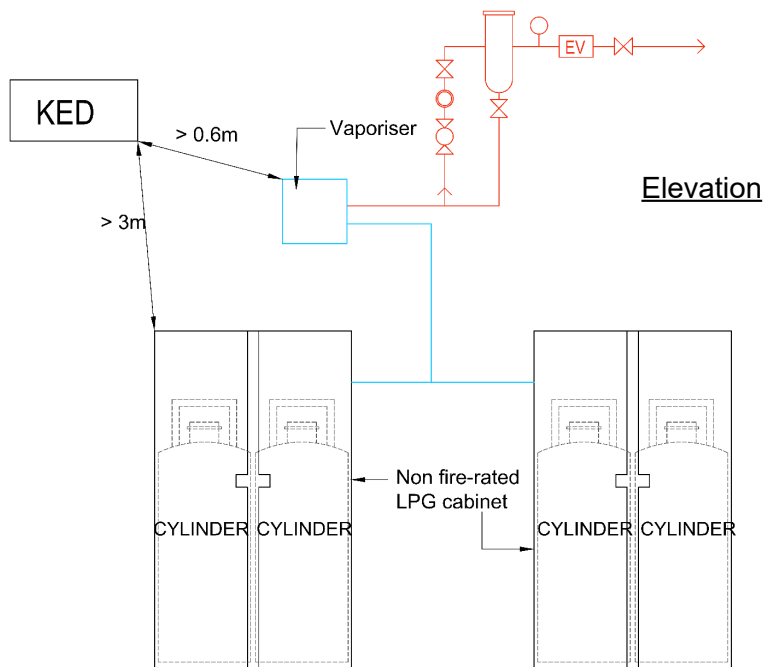

[Diagram 7.1.13c.\(4\) : Installation of non-fire-rated kitchen exhaust duct in close proximity to LPG cylinders and vapouriser](#)

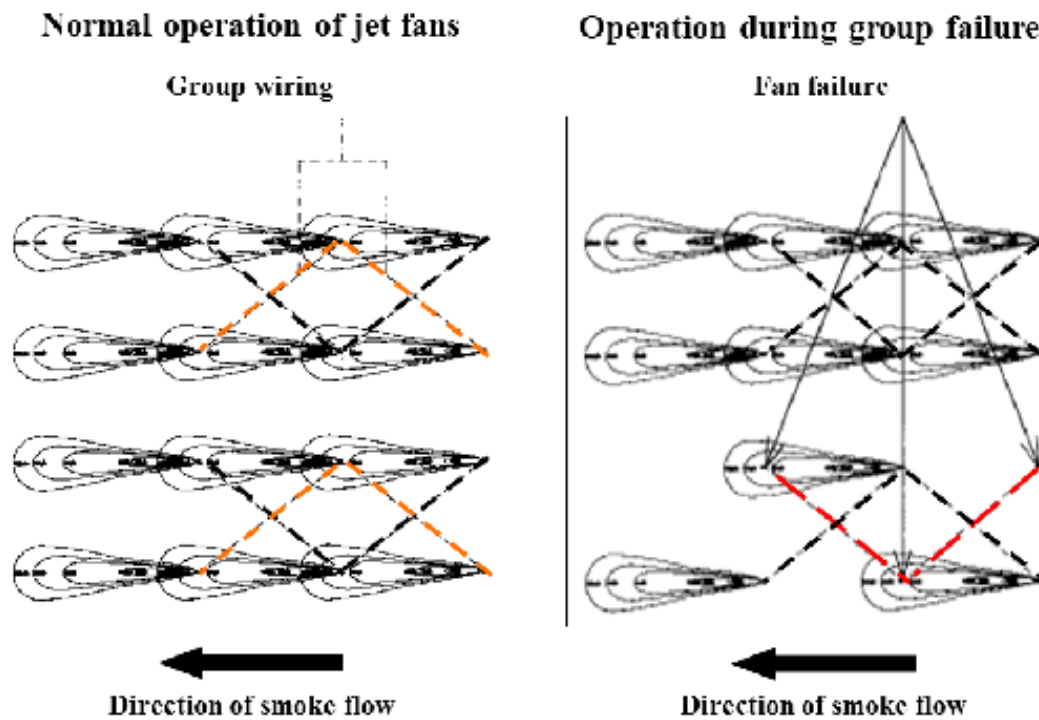

Diagram 7.4.4e.(4) - 1 : Wiring arrangement of jet fan system

Legend

Smoke-logged area <math>< 1000\text{m}^2</math>	Fire point	Car park lot
Smoke-logged where conditions of smoke temperature & visibility are met	Direction of jet fan air profile	Visibility > 25m Smoke temp <math>< 60^\circ\text{C}</math>

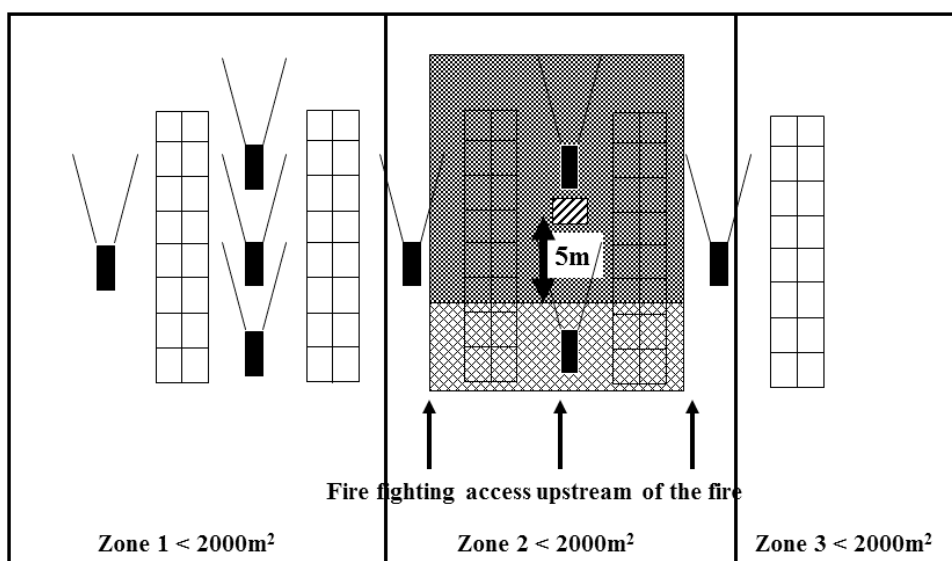
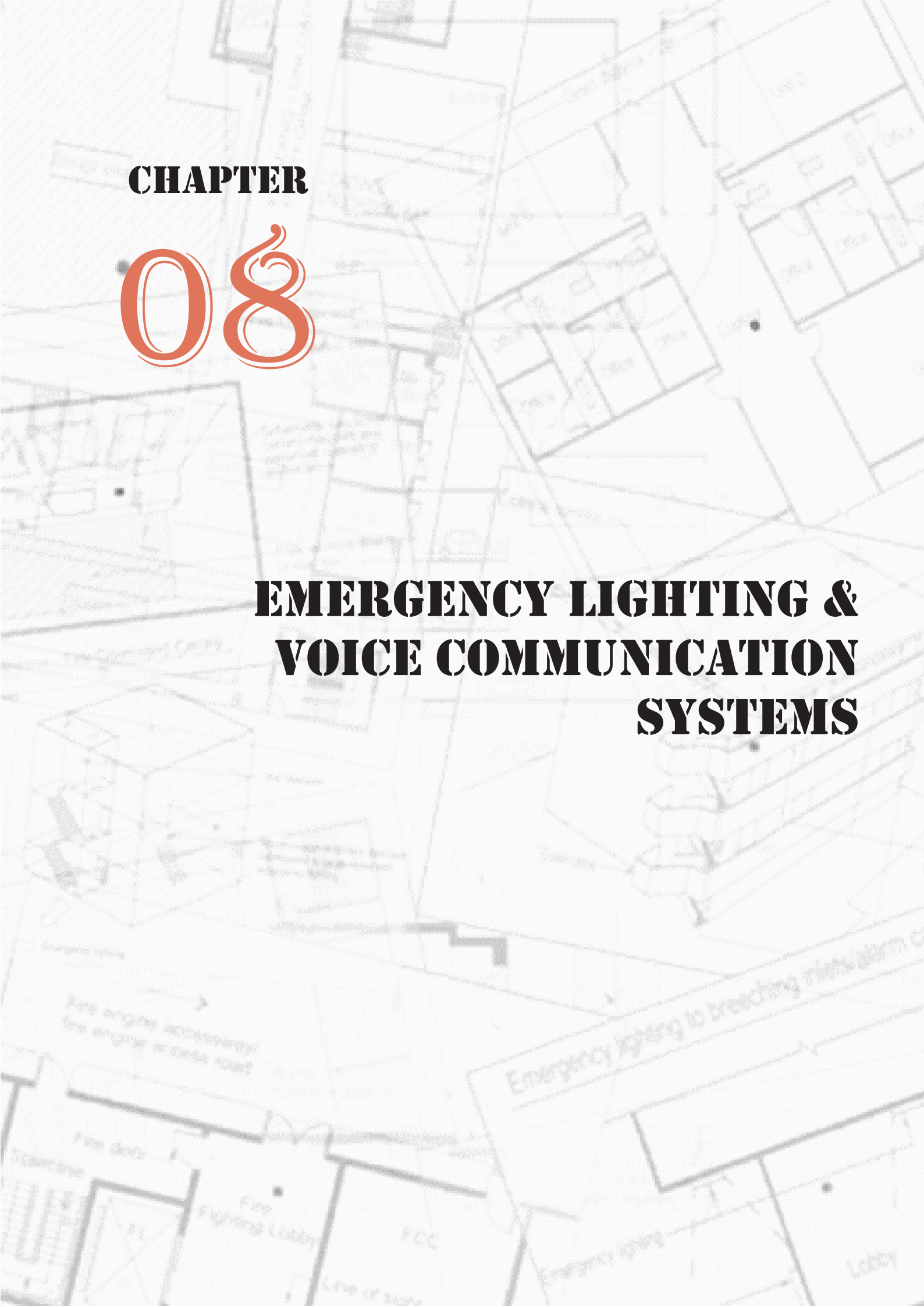

Diagram 7.4.4e.(4) - 2 : Wiring arrangement of jet fan system

CHAPTER

08

EMERGENCY LIGHTING & VOICE COMMUNICATION SYSTEMS



CHAPTER

8

EMERGENCY LIGHTING &
VOICE COMMUNICATION SYSTEMS**8.1 EXIT LIGHTING AND EXIT SIGN****8.1.1 Exit lighting**

- a. Exits of all buildings, except for PG I, shall be provided with artificial lighting facilities to the satisfaction of the requirements under this Code.
- b. The minimum illuminance to be provided for all exits and the spacing for luminaires shall be in accordance with the requirements in SS 563.
- c. The delay between the failure of the electrical supply to normal lighting and the energisation of the exit lighting shall not exceed 1 sec.

8.1.2 Emergency lighting for corridors and lobbies

- a. Emergency lighting shall be provided in all corridors and lobbies of all buildings except PG I.
- b. The minimum level of illuminance, the spacing of luminaires and the maximum delay for emergency lighting required in this clause shall be the same as that for the exit lighting.

8.1.3 Emergency lighting for occupied areas

- a. For all buildings except PG I or II, emergency lighting shall be provided in the occupied areas following the requirements below:
 - (1) along paths leading to corridors, lobbies and exits in all occupied areas where the direct distance from the entry point of the corridor, lobby or exit to the furthest point in the area concerned exceeds 13m; or
 - (2) over the whole of such area if there are no explicit paths leading to corridors, lobbies and exits.
- b. The provision of emergency lighting is exempted for:
 - (1) open-to-sky roof terrace/garden; and
 - (2) open-sided single storey building, with floor area not exceeding 200m² and openings that constitute at least 80% of the perimeter wall area (measured along the roof eaves).
- c. Notwithstanding the requirements in *Cl.8.1.3a.* above, emergency lighting shall be provided in the following locations:
 - (1) Lift cars as stipulated in this Code;

- (2) Fire Command Centres;
 - (3) Generator rooms;
 - (4) Basement car parks;
 - (5) Fire pump rooms;
 - (6) Areas of refuge within the same building.
- d. The minimum level of illuminance shall comply with the requirements in SS 563.
 - e. The delay between the failure of the electrical supply to normal lighting and the energisation of the emergency lighting for occupied areas shall not exceed 15 secs.

8.1.4 Emergency lighting for firefighting facilities

- a. Fire alarm panels, fire alarm call points and firefighting equipment shall be adequately illuminated at all times so that they can be readily located.
- b. The minimum level of illuminance shall comply with the requirements in SS 563.
- c. The delay between the failure of the electrical supply to normal lighting and the energisation of the emergency lighting for firefighting facilities shall not exceed 15 secs.

8.1.5 Secondary source of power supply

- a. The delay for energisation of the exit and emergency lighting systems between normal supply and the secondary source shall be as stipulated in the relevant clauses.
- b. Duration of the secondary source of power supply shall comply with the requirements in SS 563.
- c. Location, arrangement and control, installation of electrical wiring of the secondary source of supply, be it in the form of battery, standby generator, inverter or other accepted equipment, shall comply with the requirements in SS 563.

8.1.6 Luminaire

All exit and emergency luminaires required by this Code shall be of approved type as specified in SS 563.

8.1.7 Exit and exit directional signs

a. Exit sign

- (1) The entrance to every exit on every floor shall be clearly indicated by an

exit sign placed over the exit door. Such signs shall be placed so as to be clearly visible at all times.

- (2) Exit sign shall be provided over all the exit access doors for rooms with more than one door. (See *Diagram 8.1.7a.(2)*)

(3) Exemption

Exit sign is not required under the following situations:

- (a) PG I and II buildings
- (b) Room provided with emergency lighting
- (i) When a room is provided with only one door (see *Diagram 8.1.7a.(3)(b)(i)*); or
- (ii) When a room or internal space is fully open towards an external corridor or the external of a building.
- (c) Room without emergency lighting
- (i) When a room is provided with only one door and the direct distance from the furthest distance in the room to the exit access door is 7m or less (see *Diagram 8.1.7a.(3)(c)(i) - 1 & 2*);
- (ii) When the furthest point in the room to the exit access door is 13m or less and wall of the room comprises not less than 50% clear glazing facing (see *Diagram 8.1.7a.(3)(c)(ii)*):
- an internal corridor covered by emergency lighting,
 - an external corridor, or
 - the external of the building.
- (iii) When an internal space is fully open towards an external corridor or the external of a building.
- (d) Open-sided single storey building, with floor area not exceeding 200m² and openings that constitute at least 80% of the perimeter wall area (measured along the roof eaves).

b. Directional signs

- (1) In long corridors, in open floor areas, and in all situations where the location of the exits may not be readily visible, directional signs shall be provided to serve as guides from all portions of the corridors or floors. (See *Diagram 8.1.7b.(1)*)
- (2) In rooms where the line of sight to the exit access door is obstructed, directional sign shall be provided.

(3) Exemption

Directional sign is not required under the following situations:

- (a) PG I and II buildings.
- (b) Open-to-sky roof terrace/garden.
- (c) Open-sided single storey building, with floor area not exceeding 200m² and openings that constitute at least 80% of the perimeter wall area (measured along the roof eaves).

c. Low level signs

Additional low level or floor-mounted exit and exit directional signs shall be provided in hotel accommodation floors including boarding houses.

d. Signs within exit staircase

- (1) Where the SCDF has allowed under *Cl.2.3.5d.* for upper storey staircase to be continuous with that serving the basement, appropriate signage, including pictorials, shall be placed at strategic location inside the staircase to direct occupants out of the building in times of emergency.
- (2) Where the direction of travel to exit discharge is upward, the staircase signage required under *Cl.2.3.1b.* shall comply with SS 508.

e. Electrically-powered exit and directional signs

The legends, dimensions, design and installation of electrically-powered exit and directional signs shall comply with SS 563. Either graphic or text format can be used for the design of the signage.

f. Self-illuminating signs

The use of self-illuminating exit and directional signs powered by radioactive material are permitted in buildings, provided the signs comply with UL 924, SS 563 and SS 508 (Part 1, 2, 3 & 5). Either graphic or text format can be used for the design of the signage. In addition, SS 563 Part 1 shall be complied with for determination of the viewing distance with distance factor (*Z*) fixed at 50.

8.1.8 Photoluminescent marking

- a. In all buildings, except PG I & II, photoluminescent marking/tape to guide occupants along evacuation routes to appropriate exit shall be provided:
 - (1) along internal walls and/or floors of the exit staircase, smoke-stop lobby and fire lift lobby;
 - (2) on the doors of smoke-stop lobby, fire lift lobby and exit staircase; and
 - (3) along corridor with exit directional signs.
- b. The width of photoluminescent marking or tape shall be at least 50mm and be placed at low level. The bottom of the low level sign shall not be less than

150mm or more than 400mm above the floor level.

- c. Omission of photoluminescent marking/tape is permitted on the following conditions:
- (1) the emergency power supply of the exit lightings, exit signs and directional signs in the above locations shall be self-contained battery pack (single point emergency lighting system) in compliance with SS 563 or central battery supply backed up by stand-by generator;
 - (2) there shall be at least 2 emergency luminaires in the smoke-stop lobby, fire lift lobby and corridor with exit directional signs, such that no part of such spaces shall be left in total darkness should there be failure of any one of the emergency luminaires; and
 - (3) there shall be at least one emergency luminaire at every exit staircase landing.

8.2 EMERGENCY VOICE COMMUNICATION SYSTEM AND FIRE COMMAND CENTRE (FCC)

8.2.1 One-way emergency voice communication system

One-way emergency voice communication system and a FCC shall be provided as follows:

- a. For all large buildings under PG III (not applicable to primary school, secondary school and junior colleges), IV, V, VI, VII and VIII with AFA greater than 5000m² or having a total occupant load exceeding 1000 persons. The calculation of AFA and occupant load shall exclude the aboveground or underground car park; or
- b. For all buildings belonging to PG III, IV, V, VI, VII, and VIII of more than 24m in habitable height.
- c. For building of mixed commercial-cum-residential usage:
 - (1) where the commercial component of the building occupies only the lower portion of the building and is separated from the residential occupancies, the habitable height of the commercial component of the building exceeds 24m, or
 - (2) where a commercial component of the building is located above any residential occupancies, the habitable height of the building exceeds 24m.

d. Exception

For hotel or healthcare buildings of less than 24m in habitable height, AFA not greater than 5000m² and total occupant load not exceeding 1000 persons, an ordinary public address system shall be provided. However, FCC is not required. Loudspeakers for the ordinary public address system shall be provided in every lift lobby, staircase enclosure and

other strategic positions within audible distance of all parts of all storeys throughout the building.

8.2.2 Two-way emergency voice communication system

- a. Two-way emergency voice communication system shall be provided for
 - (1) buildings which are required to be provided with one-way emergency voice communication system under *Cl.8.2.1 a., b. and c.*; and
 - (2) all multi-level basements of buildings under PG II to VIII, except the following:
 - (a) Single-level basement, irrespective of its usage of building under PG II to VIII and basements of building of PG I.
 - (b) Multi-level basements of building under PG II, provided the basements are used solely for car parking and not exceeding two basement storeys in depth.
- b. Two-way emergency voice communication system, where required, shall provide two-way communication between the FCC and the following areas:
 - (1) Every fire lift lobby, including 1st storey
 - (2) All firefighting-related mechanical equipment rooms
(These include sprinkler pump room, wet rising main pump room, hose reel pump room, switch rooms and generator rooms.)
 - (3) All rooms housing smoke control equipment
 - (4) All lift machine rooms
 - (5) Fire lift
(Where the lift car is equipped with built-in intercom system that complies with SS 546, the two-way communication system can be exempted)
 - (6) Each area of refuge
 - (7) Air-handling control rooms
(Where AHU can be remotely monitored and controlled at the FCC, and cannot be by-passed locally, and the electrical cabling between AHU rooms and FCC are fire-rated, the two-way emergency voice communication system can be exempted.)

8.2.3 Standard

Where a one-way or two-way emergency voice communication system is required by this Code, it shall comply with the requirements stipulated in SS 546.

8.2.4 Fire Command Centre

a. Provision

A FCC shall be provided in any building, with the exception of buildings under PG I and II (PG II building having not more than two basement storeys used solely for car parking), which requires any of the following installations:

- (1) Fire lift.
- (2) Emergency voice communication system.
- (3) Engineered smoke control system.

b. Size

A FCC shall be of adequate size to house all the terminals and supervisory/control equipment, etc. of the building's fire protection/detection systems and a free working space (unobstructed by door swing) of at least 6m².

c. Location

- (1) The FCC shall be located at the same level as the fire engine accessway or fire engine access road and its entrance shall be located in the following order of priority:
 - (a) It shall be within 5m from entrance of the fire lift lobby at the designated storey of the building.
 - (b) In the case where there is no fire lift lobby, it shall be located within vicinity of the fire engine accessway or fire engine access road and within 5m from the entrance of one of the protected stairs serving all storeys of the development.
 - (c) It shall be at any other location as may be designated by the SCDF.
- (2) In the case of a site consisting of more than one building which required FCC in accordance with *Cl.8.2.1*, there shall be more than one FCC. For such cases, the SCDF shall be consulted.

d. Construction

The construction of enclosure, facilities and lighting of a FCC shall comply with the SS 546.

e. Air-conditioning and/or mechanical ventilation

Air-conditioning and/or mechanical ventilation where required for the FCC shall be provided with secondary power supply and shall have ductworks independent of any other ductwork serving other parts of the building.

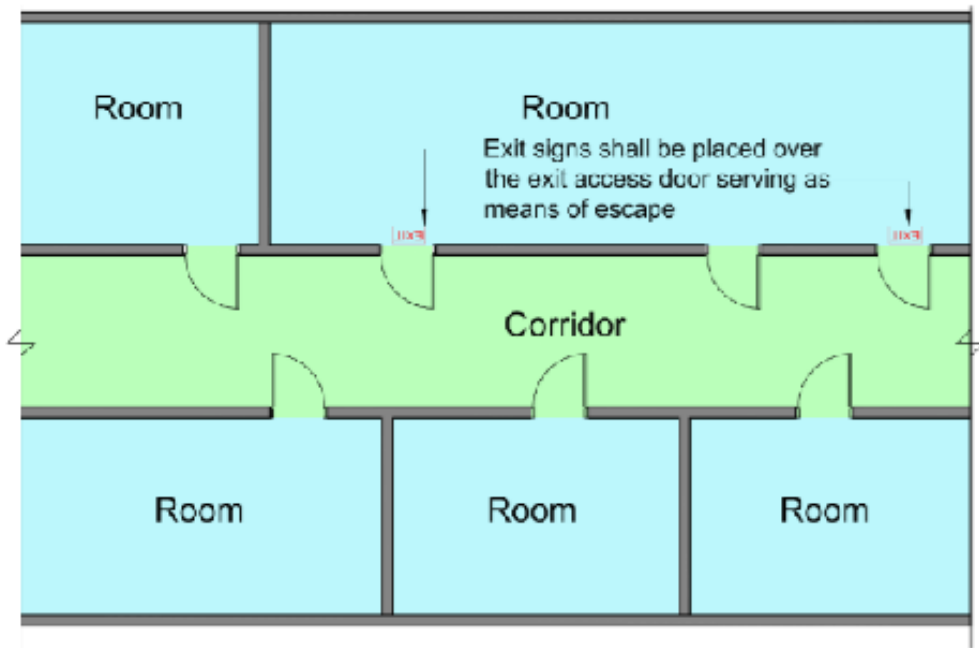

When a room is provided with more than one door, exit signs shall be provided over the exit access doors intended to be used as means of escape.

[Diagram 8.1.7a.\(2\)](#)

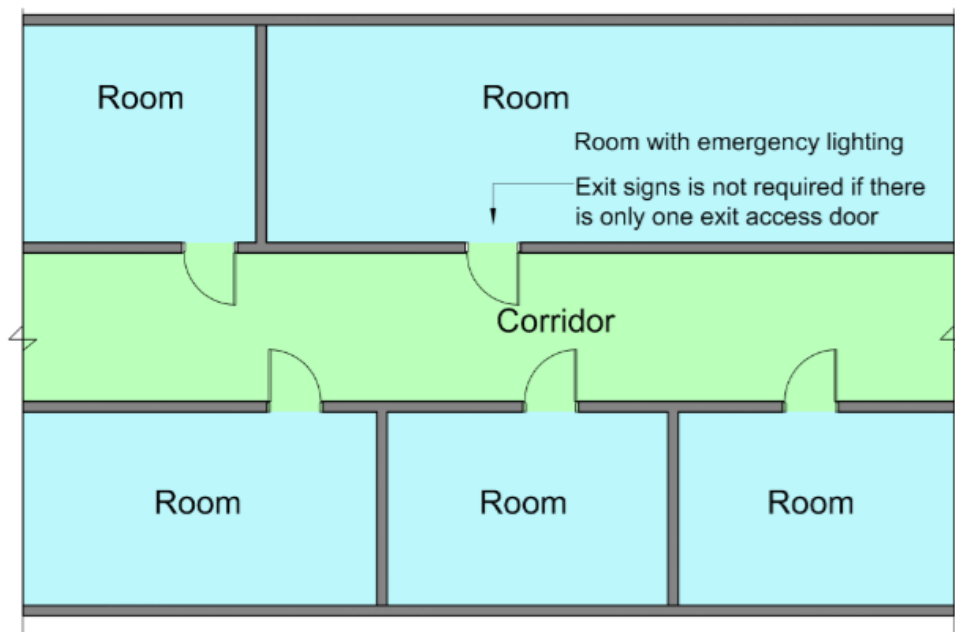

When an occupied space is provided with emergency lighting, exit sign is not required if there is only one exit access door

[Diagram 8.1.7a.\(3\)\(b\)\(i\)](#)

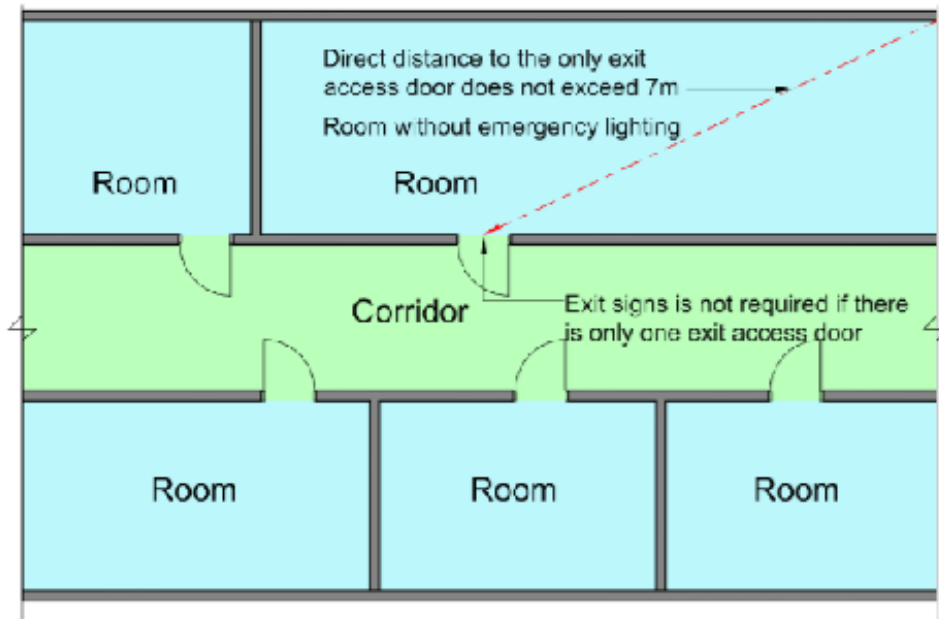

In a room without emergency lighting where the room is provided with only one door and the direct distance from the furthest distance in the room to the exit access door is 7m or less, exit sign is not required if there is only one exit access door.

[Diagram 8.1.7a.\(3\)\(c\)\(i\) - 1](#)

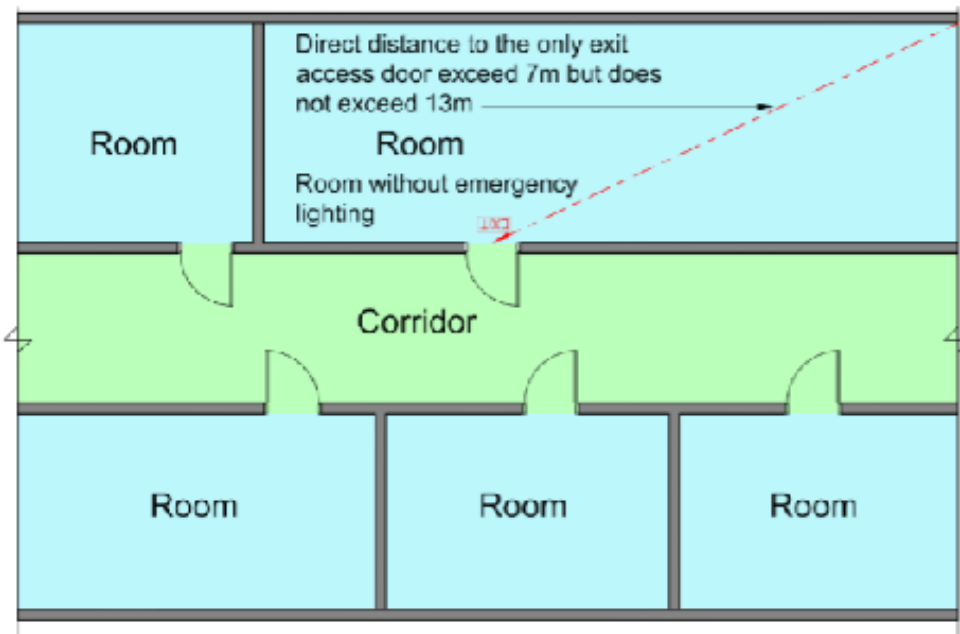

In a room without emergency lighting where the furthest point in the room to the exit access door exceeds 7m but does not exceed 13m, exit sign shall be provided over the door. Alternatively, the room can be provided with emergency lighting.

[Diagram 8.1.7a.\(3\)\(c\)\(i\) - 2](#)

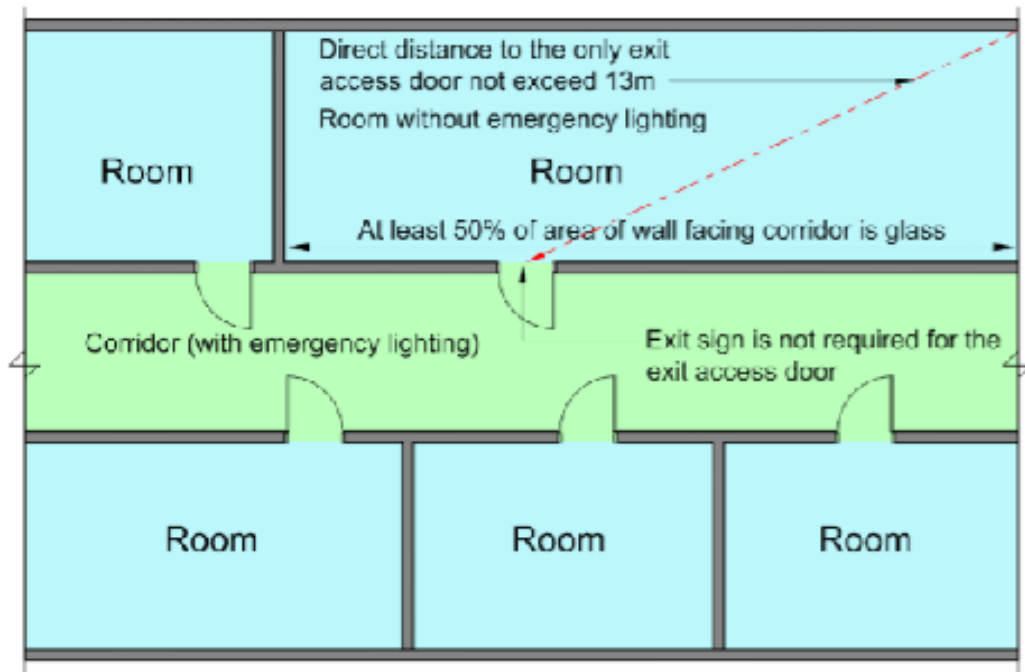

In a room without emergency lighting where the furthest point in the room to the exit access door is 13m or less and wall of the room comprises not less than 50% clear glazing facing:

- an internal corridor covered by emergency lighting
- an external corridor, or
- the external of the building.

Exit sign is not required to be provided over the exit access door.

[Diagram 8.1.7a.\(3\)\(c\)\(ii\)](#)

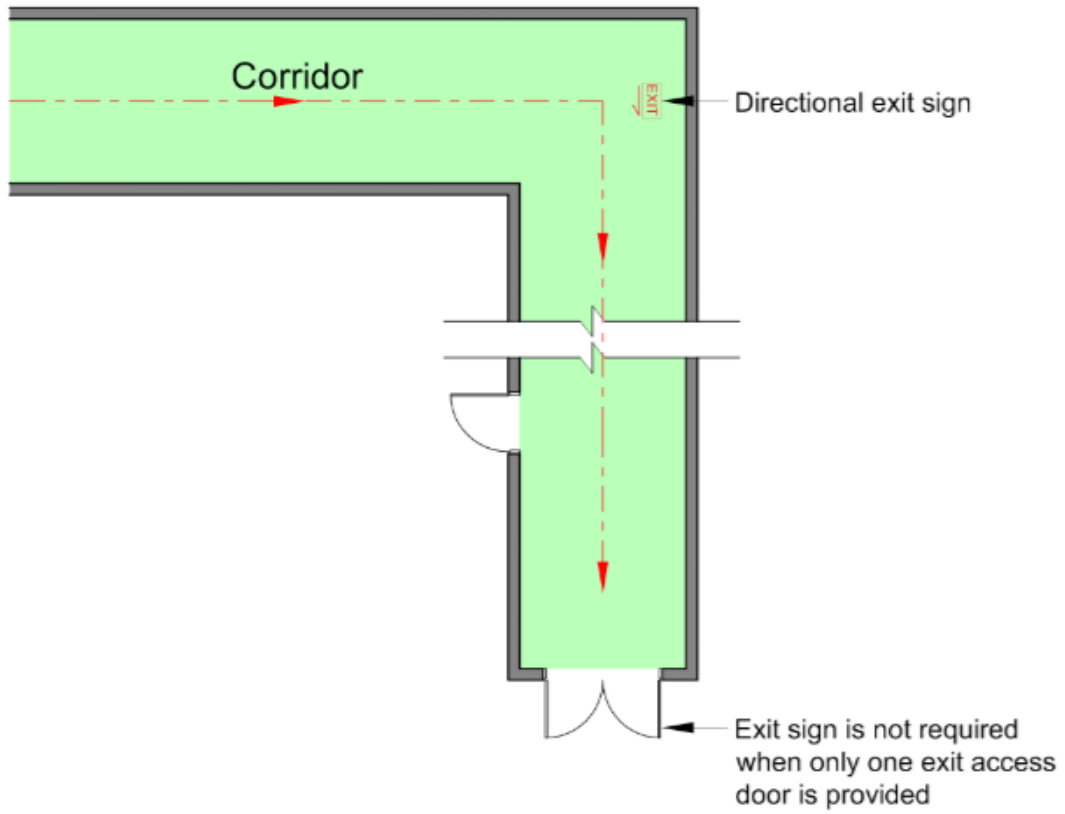

[Diagram 8.1.7b.\(1\)](#)



CHAPTER

09

**ADDITIONAL REQUIREMENTS
FOR EACH PURPOSE GROUP**

CHAPTER 9

ADDITIONAL REQUIREMENTS FOR EACH PURPOSE GROUP

This chapter specifies the requirements peculiar to buildings of respective purpose groups. These requirements shall be read in conjunction with those stipulated in Chapter 1 to 8 of this Code.

9.1 PURPOSE GROUP I OCCUPANCY

9.1.1 General

a. Means of escape

(1) **Single household dwelling**

Buildings under PG I can consist of more than three floors if they are occupied as a single household dwelling.

(2) **Basement levels**

For PG I building which has four or more levels (including the basement levels and attics), the basement levels shall discharge directly to the external space at grade level.

(3) **Access staircases**

Means of escape for a building or a separate part of a building of single occupancy of PG I can be provided via access staircases, and exit staircase under the provision of [Cl.2.3](#) is not required.

b. Structural fire precautions

(1) **Attic floor**

An attic in buildings under PG I can be constructed of timber boarding on timber joists, provided it is protected to achieve the fire resistance rating required of the elements of structure of the building or compartment.

(2) **Floor over a basement**

For PG I building which has four or more levels (including the basement storeys and attics), the floor immediately over the basement storeys shall be compartmented by compartment walls/floors. Where there is an internal connection between the basement storeys and upper levels, it shall be compartmented by a fire-rated door at the 1st storey landing.

9.2 PURPOSE GROUP II OCCUPANCY

9.2.1 General

a. Means of escape

(1) Means of escape for a building or a separated part of a building of PG II shall comply with the provision of *Cl.2.3*.

(2) **Number of exit staircases or exits per storey**

In a block of residential apartments or maisonettes, at least two independent exit staircases or other exits from every storey shall be provided, in compliance with the requirements of *Cl.2.2.11*, unless otherwise permitted.

(3) **Provision for buildings not exceeding 24m in habitable height**

In a block of residential apartments or maisonettes not exceeding 24m in habitable height, one exit staircase can be allowed provided the one-way travel distance is complied with.

(4) **Provision for buildings exceeding 24m in habitable height**

In a block of residential apartments or maisonettes exceeding 24m in habitable height, one exit staircase can be provided, subject to all of the following conditions:

(a) The building's habitable height does not exceed 60m, unless otherwise permitted by the SCDF.

(b) The single exit staircase shall serve not more than four apartments or maisonettes at each storey.

(c) Provision of exits for each residential apartment or maisonette shall comply with the requirements under *Cl.9.2.1a.(5)*.

(d) Travel distance from the most remote exit door to the exit staircase from each apartment or maisonette shall not exceed 15m.

(e) The approach to the exit staircase shall be through cross-ventilated corridor/lobby in accordance with *Cl.1.4.28*, except that the ventilation openings shall have a minimum width of 2m and a minimum height of 1.2m, as well as the following requirements:

(i) the openings shall be unobstructed from the parapet wall or balustrade level upwards and be positioned on opposite sides of the corridor/lobby such that they provide cross ventilation throughout the entire space of the corridor/lobby; and

(ii) the entire cross-ventilated corridor/lobby shall be unobstructed and maintained at minimum 2m width throughout.

- (f) Where multiple ventilation openings are provided on opposite sides of the corridor/lobby, the minimum width and height of each opening shall not be less than 1m and 1.2m respectively, provided the aggregate width of the openings at each opposite side is not less than 2m. (See *Diagram 9.2.1a.(4)(f)*)

(5) Exits from residential unit

- (a) In each residential apartment or maisonette unit, the exit access door or doors shall be provided such that the travel distance measured from any point within the unit to the entrance door(s) of the unit shall not exceed 20m. (See *Diagram 9.2.1a.(5)(a)*)
- (b) In the case of a maisonette unit comprising not more than two storeys, where a single entrance door is provided:
- (i) the door shall not be located on the upper storey of the unit; and
 - (ii) the floor area of the upper storey shall not exceed 60m², unless a separate exit is provided on this upper storey.
- (c) All exits from residential or maisonette units shall have direct access to an exit staircase, exit passageway or external space.

(6) Measurement of travel distance

Travel distance of a residential unit shall be measured from its entrance door(s) to the exit staircase. Where a residential unit requires two entrance doors at the same storey level, and if only one exit staircase is provided, the travel distance shall be measured from the most remote door. If two or more exit staircases are provided, the travel distance shall be measured from the entrance door of each unit.

(7) Smoke-free approach to exit staircase

In a block of residential apartments or maisonettes, a smoke-free approach to an exit staircase can be provided by means of an external corridor, complying with *Cl.2.3.10*.

(8) Travel distance

(a) One-way travel distance

In a block of residential apartments or maisonettes where the means of escape is through an external corridor, the one-way travel distance measured from the door of the apartment or maisonette to the exit staircase shall not exceed 20m, or 24m if the aggregate one-way travel distance within the unit and along the external corridor does not exceed 40m. The above one-way travel distances along the external corridor shall not apply to residential apartments or maisonettes in a building exceeding 24m permitted under *Cl.9.2.1a.(3)*.

(b) Two-way travel distance

In a block of residential apartments or maisonettes, the two-way travel distance can be extended to 45m if the means of escape is through an external corridor as in *Cl.2.3.10*.

In the case of buildings which are required to be provided with rising mains, the number and distribution of rising mains specified in Chapter 6 shall be complied with.

(9) **Protection of staircases**

The requirements for unprotected openings stipulated under *Cl.2.3.3a.(2)* and *Cl.2.3.3b.(2)* for internal and external exit staircases respectively need not be complied with for PG II buildings provided:

- (a) the exit staircases are cross-ventilated and maintained under smoke-free conditions at all times; and
- (b) unprotected openings of the apartment or maisonette units are not facing or ventilating into the exit staircase enclosures, as shown in *Diagram 9.2.1a(9)*.

(10) **Ventilation**

(a) Exit staircase

All exit staircases shall be naturally ventilated. Where an exit staircase is used as storey shelter, mechanical ventilation is permitted provided there are more than one exit staircase, with the remaining exit staircase(s) being naturally ventilated.

(b) Common internal corridor

- (i) The internal corridor not forming part of smoke-free approach to exit staircase shall have ventilation openings of not less than 15% of the floor area and located not more than 9m from any part of the common internal corridor.
- (ii) If the common internal corridor is cross ventilated, all of the following requirements shall be complied with:
 - The ventilation openings shall be located at high level and positioned directly opposite to each other.
 - Each ventilation opening shall be at least 50% of the superficial area of the opposing external walls.
 - No part of the floor area of the corridor shall be at a distance of more than 12m from any ventilation openings, or from the outer plane of recess void space, if ventilation opening is in recess position.

b. **Structural fire precaution**

(1) **Wall separating residential apartment or maisonette**

- (a) Each residential dwelling unit shall be compartmented from adjoining units and other parts of the same building by construction having at least 1-hr fire resistance rating and unit's exit access door of ½-hr fire resistance rating, unless otherwise permitted under *Cl.2.3.10d.*
- (b) Any compartment wall separating a residential apartment or maisonette from any other part of the same building, shall not be required to have at least 1-hr fire resistance rating unless:
 - (i) the wall forms part of a protected shaft and the minimum period of fire resistance required by the provisions of this Code for the protecting structure is more than one hour, or
 - (ii) the part of the building from which the wall separates the residential apartment or maisonette is of a different purpose group and the minimum period of fire resistance required by the provisions of this Code for any element of structure in that part is more than one hour.

(2) Attic floor

An attic in buildings under PG II can be constructed of timber boarding on timber joists, provided it is protected to achieve the fire resistance rating required of the elements of structure of the building or compartment.

9.2.2 Super high-rise residential building

a. Refuge floor

A super high-rise residential building shall be provided with at least one refuge floor at an interval of not more than 20 storeys, i.e. each refuge floor shall not serve more than the 20 storeys immediately above it. The refuge floor shall comply with all of the following requirements:

- (1) It shall be of masonry construction having at least 2-hr fire resistance rating.
- (2) At least 50% of the accessible floor area of the refuge floor shall be designated as an evacuee holding area. There shall be no residential unit or part of the unit on the refuge floor.
- (3) There shall be no commercial activities in the evacuee holding area, however, it can be used as space for physical exercises or a children's playground. All equipment placed within the evacuee holding area shall be made/constructed of non-combustible materials.
- (4) The size of the evacuee holding area shall be adequate to accommodate at least the total occupant load of all storeys above the refuge floor, up till the next higher refuge floor, or the remaining floors, based on 0.3m² per person.

- (5) The evacuee holding area shall be separated from other areas of the refuge floor by compartment walls having at least 2-hr fire resistance rating. Linking of the evacuee holding area with other occupied rooms/ areas shall be via an external corridor, or a smoke-stop lobby complying with *Cl.2.2.13a.*
- (6) The evacuee holding area shall be naturally ventilated with permanent openings on at least two sides of the external walls, with total area of at least 25% of the floor area of the evacuee holding area.
- (7) The minimum height (measured from the sill to the top) of each opening shall be at least 1.2m.
- (8) All parts of the evacuee holding area shall be within 9m of a ventilation opening.
- (9) Ventilation openings shall be located at least 1.5m horizontally from and 3m vertically above unprotected openings, except for ventilation openings which total area as specified in *Cl.9.2.2a.(6)* above is at least 50% of the evacuee holding area, the vertical distance from the unprotected openings can be reduced to 1.5m.
- (10) A sprinkler system shall be provided for the refuge floor if there is any non-residential room located on the same floor.
- (11) Escape routes leading to the evacuee holding area shall be through a smoke-stop/fire lift lobby or external corridor.
- (12) Emergency lighting shall be provided to cover all areas of the evacuee holding area. Such lighting shall be connected to a secondary power supply, i.e. generator, battery, etc., and shall be able to provide horizontal luminance at floor level of not less than 5 lux. The delay between the failure of the electrical supply for normal lighting and the energization of the emergency lighting for occupied areas shall not exceed 15 secs.

b. Provision of fire lift

- (1) The fire lift car shall have a clear area/space of not less than 1.7m (depth) x 1.5m (width).
- (2) Two-way emergency voice communication system shall be provided between the fire lift lobby at the refuge floor and the following locations in order of priority:
 - (a) FCC, or
 - (b) Main alarm panel, or
 - (c) Respective fire lift lobby at grade level nearest the fire engine access road.
- (3) At least two fire lifts shall be provided for a super high-rise residential building.

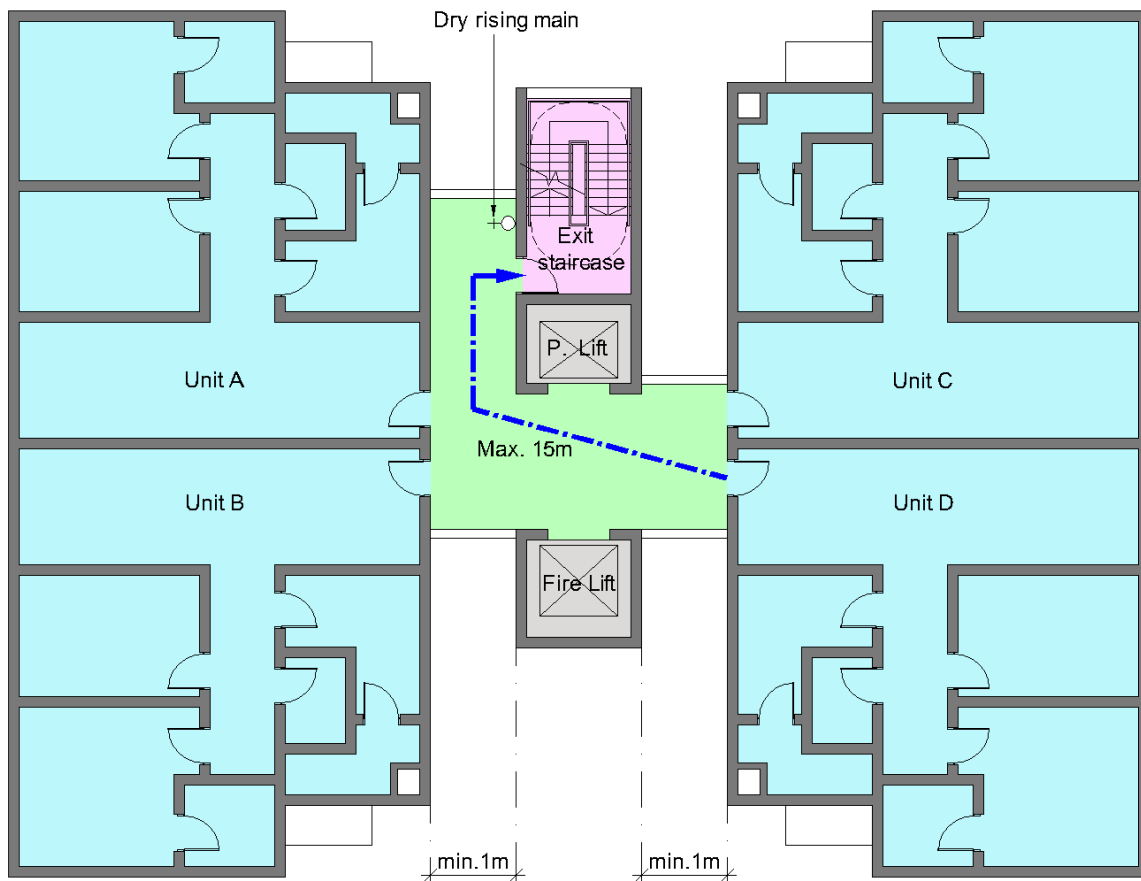
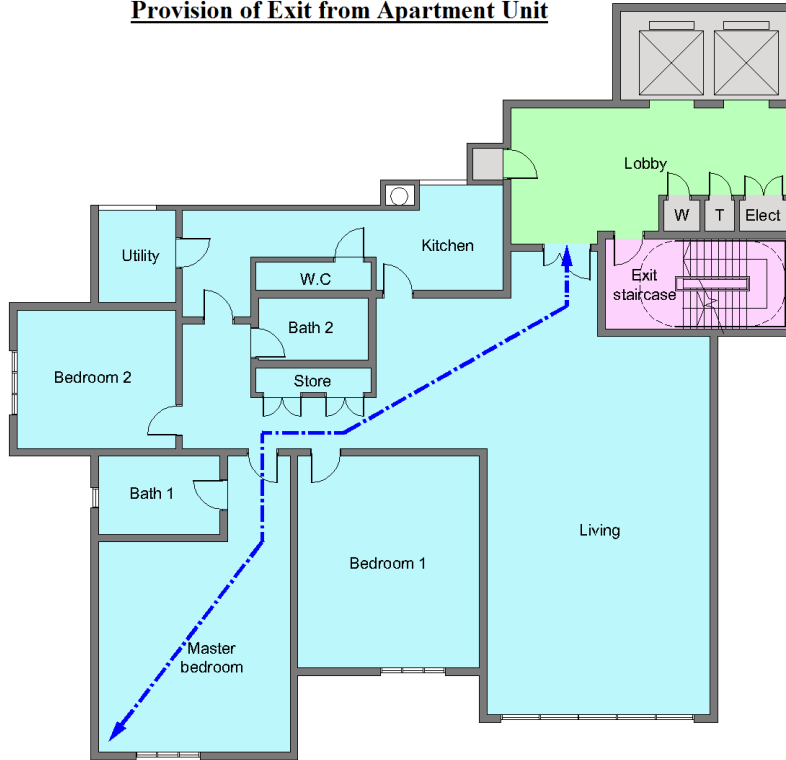

Diagram 9.2.1a.(4)(f) : Provision of exit staircase for residential building not exceeding 60m in habitable height

In a block of residential apartments or maisonettes not exceeding 60m in habitable height, one exit staircase only can be provided to every storey

Provision of Exit from Apartment Unit



←---→ Travel distance from any point within unit to the exit door (max. 20m)

[Diagram 9.2.1a.\(5\)\(a\) : Provision of exit for apartment unit](#)

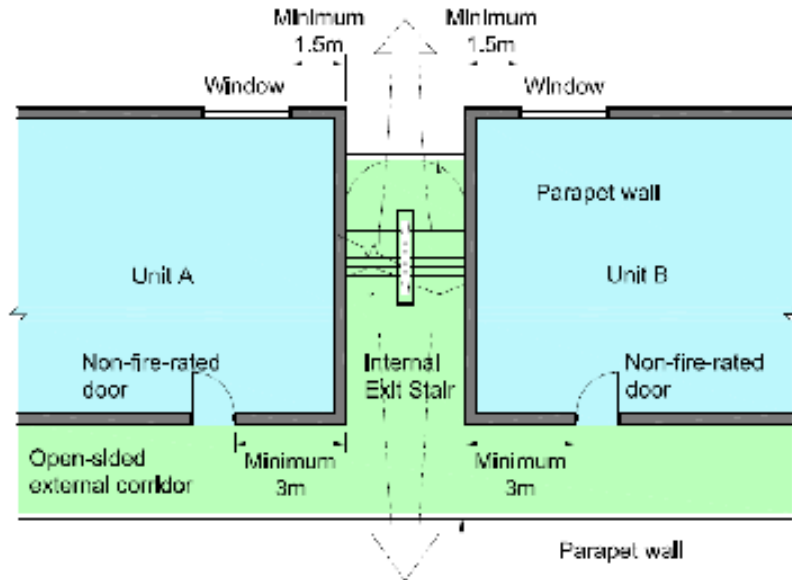

[Diagram 9.2.1a.\(9\) : Cross-ventilated exit staircase to residential apartment/maisonette](#)

Exit staircase is cross-ventilated and maintained under smoke-free condition at all times. Unprotected openings of the apartment/maisonette units are not facing or ventilating into the exit staircase enclosure.

9.3 PURPOSE GROUP III OCCUPANCY

9.3.1 General

(Not in use)

9.3.2 Healthcare occupancy

a. **General**

Sprinkler shall be provided for healthcare occupancy with patient accommodation if:

- (1) it comprises more than one storey, or
- (2) it is located on an upper storey other than first storey, or
- (3) its largest non-compartmented AFA exceeds 750m².

b. **Hospital**

They shall comply with the following additional requirements:

(1) **Basement**

Patient accommodation area containing beds shall not be located in basement storeys.

(2) **Width of exit**

The minimum clear width of an exit door opening shall be not less than 1.2m.

(3) **Number of exits per ward**

For patient accommodation wards where the occupant load exceeds 50 persons, each ward shall be provided with at least two exits, which shall be remotely located from each other.

(4) **Provision of area of refuge**

Every upper storey used for the accommodation of patients shall be provided with at least one area of refuge. The size of the area of refuge shall be computed based on [Table 1.4B](#). For hospital and nursing home, the area of refuge shall be sized adequately to accommodate the number of beds of minimum dimension 2.55m (length) by 1.1m (width) and computed based on occupant load factor of 2.8m²/person for the ward served by the area of refuge. .

(a) For area of refuge not adjacent to the patient ward, the routes leading to the area of refuge shall be through:

- (i) an external corridor complying with [CI 2.3.10](#), or
- (ii) a protected lobby separated from the adjoining areas of the

building by a wall and door of at least 1-hr fire resistance rating. The protected lobby shall have a minimum size of 4m (length) by 2m (width) and ventilated in accordance with *Cl 2.2.13b.(7)(a)* or *(b)*.

- (b) For area of refuge immediately adjacent to a patient ward, the routes leading to the area of refuge need not be through an external corridor provided both the area of refuge and the adjacent patient ward are:
 - (i) fire compartmented from each other by a wall and door of at least 1-hr fire resistance rating;
 - (ii) provided with engineered smoke control and the design smoke layer height shall be at least 2.5m above the finished floor; and
 - (iii) provided with minimum of 2 remotely located exit access between them.

(5) Size and compartmentation of patient accommodation area

- (a) Each patient accommodation ward shall not exceed a floor area of 750m² and an occupant load of 75 persons, calculated on the basis of Accessible Floor Area (AFA) of 10m² per person.
- (b) For single storey premises not protected by sprinkler, each patient accommodation ward shall be constructed as a compartment having at least 1-hr fire resistance rating and at least ½-hr fire resistance rating door for protection of door openings. It shall be provided with both an automatic fire alarm system.
- (c) For sprinkler-protected premises, patient accommodation ward area shall not exceed a fire compartment size 2100m² and shall be separated by full-height smoke barrier (up to soffit of the slab) for patient rooms of aggregated area not exceeding 750m² within the ward.

(6) Provision of fire escape bed lifts

- (a) At least two fire escape bed lifts shall be provided for premises with more than one storey. They shall be located remotely from each other and sited adjacent to a protected exit staircase. Each area of refuge shall also be served by at least one fire escape bed lift. Fire lift can double-up as a fire escape bed lift provided there is more than one fire lift and at least one shall remain as a dedicated fire lift. Where the fire lift doubles up as fire escape bed lift, its dimension shall be as specified in *Cl.9.3.2b.(6)(c)*.
- (b) The fire escape bed lift shall be contained within a protected shaft, constructed to comply with the relevant requirements under *Cl.3.8*.
- (c) The entry into the fire escape bed lift and the protected exit

staircase shall be through a common protected lobby. The fire escape bed lift shall have a minimum clear platform size of 2.8m (depth) by 1.8m (width). The protected lobby shall have a minimum size of 5m (length) by 4m (width). In the situation where the protected lobby is also serving as a smoke-stop lobby or fire lift lobby, the floor area of the lobby shall be of sufficient size to accommodate both the evacuation of the required number of beds, as well as the passage of other occupants into the protected staircase.

- (d) A signage shall be displayed outside the bed lift stating “FIRE ESCAPE BED LIFT”.
- (e) The escape route for the fire escape bed lift at the 1st storey level shall be protected from other occupancy areas by 1-hr fire resistance separation and shall discharge directly into an external space.
- (f) An fire escape bed lift that opens directly into an external corridor and which is sited adjacent to a protected exit staircase does not require a protected lobby, provided there is no unprotected opening within 3m horizontally from the fire escape bed lift door opening. The fire escape bed lift provided in this situation may be treated as a common bed lift that can serve multiple compartments located on the same floor.
- (g) An fire escape bed lift shall be provided with the following features:
 - (i) a secondary power supply from an emergency generating plant;
 - (ii) a switch labelled “Fire Escape Bed Lift”, situated next to the lift landing door at the final exit storey, which enables an authorised person nominated by the building management to take control of the lift car during an emergency. The operating of the switch shall be similar to fire lift operational features stipulated in SS 550. Such a switch is not needed in two-storey buildings;
 - (iii) a communications system (except in two-storey buildings) shall be installed to allow communication between occupants at each lift landing and the operator in the lift car; and
 - (iv) the installation of fire escape bed lifts shall be in accordance with SS 550.

(7) Internal access to wards

A patient accommodation ward with access through an internal corridor shall comply with the following requirements:

- (a) each ward shall be separated from the internal corridor by a wall having at least 1-hr fire resistance rating;
- (b) doors opening into an internal corridor shall have at least ½-hr fire resistance rating and be fitted with an automatic self-closing device to comply with the requirements of *Cl.3.9.2*; or be held open by an electromagnetic or electromechanical device;
- (c) requirements on fire compartmentation under *Cl.9.3.2b.(7)(a)* and *Cl.9.3.2b.(7)(b)* can be relaxed up to a size of 2100m² as per *Cl.9.3.2b.(5)(c)*, if the premises is sprinkler-protected;
- (d) an internal corridor shall be naturally ventilated with fixed openings in an external wall, such ventilation openings being not less than 15% of the floor area of the internal corridor;
- (e) the ventilation opening in the external walls shall not be less than 3.5m², with at least 1.75m² on each side shall be unobstructed by parapet walls or balustrade levels upwards and be positioned on opposite sides of the internal corridor such that they provide effective cross ventilation throughout the entire space of the corridor;
- (f) the ventilation openings in the external walls shall not be more than 12m from any part of the internal corridor;
- (g) an internal corridor can be provided with mechanical ventilation and pressurisation in lieu of natural ventilation; and
- (h) other non-patient accommodation areas or spaces which open into or form part of the internal corridor, and which can jeopardise the means of escape provision, shall be compartmentalised by 1-hr fire-rated enclosures and ½-hr fire-rated doors unless otherwise allowed under *Cl.9.3.2b.(4)(b)* and *Cl.9.3.2b.(6)(c)*.

(8) External access to wards

External access to a patient accommodation ward shall be through external corridor complying with *Cl.2.3.10*.

(9) Smoke-free approach to exit staircase

- (a) Entry into an exit staircase from any part of a building of more than four storeys above ground level shall comply with the requirements of smoke-free approach to an exit staircase, as stipulated in *Cl.2.2.13*.
- (b) Where a smoke-stop lobby is provided to an exit staircase to serve a patient accommodation floor, or any area where patients may need to be evacuated on mattresses or stretchers, the lobby shall have a minimum clear space (unobstructed by door swing) of 6m².

(10) Staircase landing width/depth

- (a) Exit staircases that serve a patient accommodation floor to be used by patients in an emergency fire situation shall be designed to allow the evacuation of patients on mattresses or stretchers.
- (b) The width of stairs, and staircase landing width and depth shall comply with [Table 9.3A](#).

c. Nursing home, convalescent home, home for the aged and hospice

They shall comply with the full requirements stated under [Cl.9.3.2a.](#) and [b.](#) for hospital.

d. Custodian care facility

It shall comply with the following additional requirements:

- (1) where such facilities are located within a building of mixed use, they shall be compartmentalised from other spaces and occupancies by walls and doors having at least 1-hr fire resistance rating;

Exception:

The requirement on the provision of fire compartmentation will not apply if the building is sprinkler-protected.

- (2) where such facilities are located on the 1st storey, they shall be provided with direct access to the exterior of the building;
- (3) where located on upper storeys, they shall have direct access through a smoke-stop lobby to the staircase (minimum one exit staircase);
- (4) where there is no fire lift lobby or smoke-stop lobby, there shall be at least one direct access to the exit staircase;
- (5) institutions for the mentally disabled shall be designed with each storey having an area of refuge in accordance with [Cl.1.4.9](#) and [Table 1.4B](#); and
- (6) fire safety requirements under [Cl.9.3.2b.](#) - Hospital, shall be fully complied with, except [Cl.9.3.2b.\(6\)](#) on provision of escape bed lift and [Cl.9.3.2b\(10\)](#) on staircase landing width/depth.

e. Supervisory care facility

It shall comply with [Cl.9.3.2a. and b.](#), except [Cl.9.3.2b.\(6\)](#) on provision of fire escape bed lift and [Cl.9.3.2b.\(10\)](#) on staircase landing width/depth.

f. Ambulatory healthcare centre

It shall comply with the following additional requirements:

- (1) if located within a building of mixed use, shall be compartmentalised from other tenants and occupancies by walls and doors having at least 1-hr fire resistance rating;

- (2) shall be provided with its own means of escape to at least one exit staircase; and
- (3) shall fully comply with *Cl.9.3.2a.* and *b.*, except *Cl.9.3.2b.(4)* on provision of area of refuge for horizontal evacuation, *Cl.9.3.2b.(6)* on provision of fire escape bed-lift and *Cl.9.3.2b.(10)* on staircase landing/depth.

g. Other outpatient clinics

For outpatient clinics that do not fall under the above categories, the fire safety requirements under *Cl.9.3.2b.* are not applicable. Instead, these clinics shall comply with the provision of fire-rated wall to separate the clinics from other usage as stipulated in *Cl.3.2.5b.*, except for the frontage of the clinic.

9.3.3 Workers' dormitory

Workers' dormitories shall comply with the following additional requirements:

a. Size

Each dormitory bedroom shall not exceed 120m² and an occupant load of 40 persons.

b. Occupant load

The occupant load shall be based on accessible floor area on the basis of 3m² per person.

c. Number of exit staircases or exits per storey

There shall be at least two independent exit staircases or other exits from every storey of a workers' dormitory.

d. Maximum travel distance

The travel distance, measured from the most remote point of the dormitory bedroom to the nearest exit staircase or other storey exit, shall not exceed the maximum travel distance permitted under *Table 2.2A.*

e. Internal corridor to dormitory bedrooms

Dormitory bedrooms with access through an internal corridor shall comply with the following requirements:

- (1) dormitory bedrooms shall be separated from the internal corridor by a wall having at least 1-hr fire resistance;
- (2) doors opening into internal corridors shall have at least ½-hr fire resistance and be fitted with an automatic self-closing device to comply with the requirements of *Cl.3.9.2*; and
- (3) internal corridors shall be naturally cross-ventilated with fixed openings on the external walls, with such ventilation openings having an aggregate free area of:
 - (a) at least 15% of the total floor area of the internal corridor, or

(b) at least 3.5m², whichever is greater.

- (4) each ventilation openings in the external walls shall have at least 1.75m² free area, unobstructed by parapet walls or balustrade levels such that they provide effective cross-ventilation throughout the entire space of the corridor;
- (5) the ventilation openings in the external walls shall not be at most 12m from any part of the corridor;
- (6) pressurisation of internal corridors in lieu of natural ventilation is not permitted; and
- (7) other rooms or spaces which open into or form part of the bedroom corridor and which can jeopardise the means of escape shall be compartmented by enclosures with at least 1-hr fire-resistance rating and doors with at least ½-fire resistance rating.

f. External access to dormitory bedrooms-

External access to dormitory bedrooms shall be through an external corridor complying with *Cl.2.3.10*.

g. Smoke-free approach to exit staircase

Entry into an exit staircase from any part of a building of more than four storeys above ground level shall comply with requirements of *Cl.2.2.13* - requirements of smoke-free approach to exit staircase. Pressurisation of a staircase in lieu of the provision of smoke-stop lobby is not permitted.

h. Bedroom compartmentation

- (1) Each dormitory bedroom shall be compartmented from adjoining rooms and other parts of the same building by construction having at least 1-hr fire resistance rating, unless otherwise permitted under *Cl.9.3.3f*. for the provision of window openings between the bedroom and external corridor;
- (2) Dormitory bedrooms and other rooms or spaces which open into or form part of the dormitory bedroom corridor shall be separated from the corridor to comply with *Cl.9.3.3e*. and *Cl.9.3.3f*.; and
- (3) Kitchen shall be enclosed with at least 1-hr fire-rated compartment wall, including at least ½-hr fire-rated door. Kitchen can be located within each floor, but shall not be within the dormitory bedroom.

9.3.4 Temporary workers' quarter in uncompleted permanent buildings on construction sites

a. General

- (1) The temporary workers' quarters shall not be located higher than 10m above the fire engine access road level of the uncompleted building and shall not be lower than first basement level.

- (2) The temporary workers' quarters shall only be used for housing workers working within the construction site.
- (3) Hot work is not allowed in the basement(s) where the temporary workers' quarters are located.

b. Means of escape

- (1) For aboveground levels, provision of only one exit staircase is permitted provided that the one-way travel distance is complied with and the occupant load does not exceed 20 persons on any storey. The exit staircase shall discharge directly to exterior open space.
- (2) At least two independent exit staircases shall be provided for the temporary workers' quarters located in basement levels or when the occupant load exceeds more than 20 persons on any storey.

c. Compartmentation

- (1) Cooking is only allowed at a designated kitchen area, including basement(s). Such kitchen, shall be enclosed with at least 1-hr fire-rated compartment wall and at least ½-hr fire-rated door and shall not be located within the dormitory unit.
- (2) Office and storage are allowed in the basement(s) where the temporary workers' quarters are located. They shall be compartmented from the accommodation areas with at least 1-hr fire-rated compartment wall and at least ½-hr fire-rated door.

d. Fire engine access

- (1) Provision of fire engine access road shall be provided in accordance with the requirements for the development. Only the portion of the fire engine access road serving the temporary workers' quarters shall be made available.
- (2) Where the remotest temporary workers' quarter is located not more than 100m away from the site entrance at the public road, provision of working private fire hydrant is exempted.
- (3) A temporary "dry" fire hydrant is allowed. The "dry" fire hydrant shall be connected to a 150mm diameter pipe, which shall be connected the other end to a 4-way breeching inlet. This breeching inlet shall be within 18m from any fire engine accessway or fire engine access road having minimum 4m width and within 50m from any wet fire hydrant.

e. Emergency power supply

Emergency power supply lasting at least 2-hr shall be provided for all systems requiring it.

f. Firefighting systems

- (1) Where dry riser system is required for the main development, they shall be commissioned and made operable for the storeys housing the

temporary workers' quarters during the accommodation period.

- (2) Provision of automatic sprinkler system and smoke control system is exempted for basement provided all of the following requirements are complied with:
 - (a) The basement is effectively cross-ventilated as follows:
 - (i) no point within the basement(s) is more than 12m from any vertical opening or void for spaces that are in between two openings or voids;
 - (ii) no point shall be more than 6m from any opening or void for spaces that are ventilated by such opening or void on only one side;
 - (iii) all ventilation openings shall be at least 1000 x 600mm; and
 - (iv) the total aggregate area of these voids and vertical openings shall be at least 20% of the total basement floor area.
 - (b) The occupant load is computed based on 6m² per person.
- (3) An automatic fire alarm system shall be provided if provision of automatic fire sprinkler system is exempted for the temporary workers' quarters located in the basement(s).
- (4) For temporary workers' quarters located above ground level, fire alarm system shall be provided as stipulated under [Table 6.3A](#).
- (5) Connection of fire protection systems to the approved alarm monitoring company is not required.

g. Engineered smoke control system

Engineered smoke control and sprinkler systems shall be required for the basement levels where the workers' quarters are located, if the provision of cross ventilation stipulated in *Cl.9.3.4.f.* cannot be fulfilled.

h. Storage of hazardous materials

All stores of highly flammable substances shall be sited in open space at a minimum distance of 5m away from the building where the temporary workers' quarters are located and shall comply with the relevant standards.

TABLE 9.3A STAIRCASE LANDING WIDTH/DEPTH			
Stair Width (m)	Minimum Landing width (m)	Minimum Landing Depth (m)	
1	2.8	1.9	Allows mattress or stretcher evacuation only (i.e. no pedestrian passing)
1.25	2.8	1.9	Allows mattress or stretcher evacuation and restricted ambulant passing
1.5	3.2	1.55	
1.75	3.6	1.35*	Allows mattress or stretcher evacuation and ambulant passing.
2	4	1.25*	

Note:

* = Clear landing depth, instead of the clear stair width, shall be taken for the purpose of calculating the exit capacity of the staircase.

9.4 PURPOSE GROUP IV OCCUPANCY

9.4.1 General

a. Means of escape

(1) **Aboveground office floors**

One exit staircase is permitted to serve an aboveground office floor provided:

- (a) the habitable height of the floor does not exceed 15m;
- (b) the floor does not be located above 4th storey; and
- (c) the AFA of the floor does not exceed 200m².

(2) **Underground office floors**

One exit staircase is permitted to serve an office basement provided:

- (a) the building is of non-combustible construction;
- (b) the depth of basement storey does not exceed 9m below the average ground level;
- (c) compartment below ground does not comprise more than one storey; and
- (d) the AFA of each basement storey, including service ducts, lift shafts, toilets, staircase, etc., does not exceed 200m².

b. Structural fire precautions

(Not in use)

9.5 PURPOSE GROUP V OCCUPANCY

9.5.1 General

a. Means of escape

(1) **Aboveground shop floors**

One exit staircase is permitted to serve an aboveground shop floor provided:

- (a) the habitable height of the floor does not exceed 15m;
- (b) the floor does not be located above 4th storey; and
- (c) the AFA of the floor does not exceed 200m².

(2) **Underground shop floors**

One exit staircase is permitted to serve a shop basement provided:

- (a) the building is of non-combustible construction;
- (b) the depth of basement storey does not exceed 9m below the average ground level;
- (c) compartment below ground does not comprise more than one storey; and
- (d) the AFA of each basement storey, including service ducts, lift shafts, toilets, staircase, etc., does not exceed 200m².

b. Structural fire precautions

(Not in use)

9.5.2 Outdoor Display Areas (ODAs)

a. General

This set of fire safety requirements shall be applicable to the following four types of Outdoor Display Areas (ODAs).

(1) **Non-roofed-over ODAs detached from building**

This refers to the ODAs where goods are displayed at the outdoors without any roofing. An example of this type of ODAs is the outdoor flea market.

(2) **Roofed-over ODAs detached from building**

This refers to the ODAs where goods are displayed at the outdoors with roofing. An example of this type of ODAs is the outdoor kiosk.

(3) **ODAs along covered walkway**

This refers to the ODA where goods are displayed along the

common walkway in front of a shop unit.

(4) ODAs with extended awning/canopy

This refers to the ODAs where goods are displayed underneath the awning/canopy from a shop front.

b. Fire Safety Requirements for Outdoor Display Areas (ODAs)

(1) Non roofed-over ODAs detached from building

- (a) The goods display area shall be located at least 3m from the roof eaves and/or boundaries of the neighbouring buildings.
- (b) There is no control on the size/height of the ODAs and the materials used for displaying goods at the ODAs.

(See *Diagram 9.5.2b.(1)*)

(2) Roofed-over ODAs detached from building

- (a) The goods display area shall be located at least 3m from the roof eaves and/or boundaries of the neighbouring buildings.
- (b) The maximum total length of stalls shall not exceed 6m. A separation distance of at least 3m shall be provided between stalls if the total length exceeds 6m. However, the continuous length of stalls can exceed 6m if hose reel is provided to cover these stalls.
- (c) There is no control on the size/height of the ODAs and the materials used for displaying goods at the ODAs.

(See *Diagram 9.5.2b.(2)*)

(3) ODAs along covered walkway

- (a) A clear width of not less than 1.2m shall be maintained along the covered walkway at the shop front.
- (b) Racks for displaying goods shall not exceed 3m in length. There shall be a minimum 1m wide clear path between rows of racks. Goods shall not be stacked higher than 2m above floor level.
- (c) There shall not be any drop-down screen at the ODAs for protecting merchandises from weather elements, except the retractable type approved by the SCDF. The retractable screen shall retract upon activation of smoke detectors or during a power failure.
- (d) Goods shall not be placed within 3m from the discharge points of exit staircases. However, if there is more than one exit staircase or there is a rear escape at the 1st storey for single exit staircase, the distance can be reduced to 1.5m.

- (e) Goods, shelves or racks shall not be left overnight at the ODAs outside the shop after operating hours.
- (f) Hose reel shall be provided to cover the ODAs if the total area of shop and ODAs per unit exceeds 150m² or if the unit above the shop is used for non-residential purposes. The hose reel shall be located not more than 5m from exit.

(See *Diagram 9.5.2b.(3)*)

(4) ODAs with extended awning/canopy

- (a) The depth of awning/canopy shall not exceed 2.4m. There is no restriction on the use of material for the awning/canopy.
- (b) The awning/canopy shall be set back at least 3m from the discharge points of exit staircases. However, if there is more than one exit staircase or there is a rear escape at the first storey for single exit staircase, the distance can be reduced to 1.5m.
- (c) Goods, shelves or racks shall not be left overnight at the ODAs outside the shop after operating hours.
- (d) A clear width of at least 1.2m shall be maintained along the covered walkway at the shop front.
- (e) Racks for displaying goods shall not exceed 3m in length. There shall be a minimum 1m wide clear path between rows of racks. Goods shall not be stacked higher than 2m before floor level.
- (f) There shall not be any drop-down screen at the ODAs for protecting merchandises from the weather elements, except the retractable type approved by the SCDF. The retractable screen shall retract upon activation of smoke detectors or during a power failure.
- (g) Hose reel shall be provided to cover the ODAs if the total area of shop and ODAs per unit exceeds 150m² or if the unit above the shop is used for non-residential purposes. The hose reel shall be located not more than 5m from exit.
- (h) For sprinkler-protected buildings, the sprinkler system shall be extended to cover the ODAs. The sprinkler shall not be obstructed by the stacked merchandises and a minimum vertical clearance of 500mm shall be maintained between the goods and the sprinkler heads.

(See *Diagram 9.5.2b.(4)*)

(5) Other fire safety requirements applicable to all ODAs

- (a) There shall be no open-flame activities at the ODAs.

- (b) The ODAs shall not encroach onto any fire engine accessway/fire engine access road.
- (c) Fire extinguisher(s) shall be provided to cover the ODAs so that no person needs to travel more than 15m to reach an extinguisher. For roofed-over ODAs detached from building, fire extinguisher shall be provided for each stall.

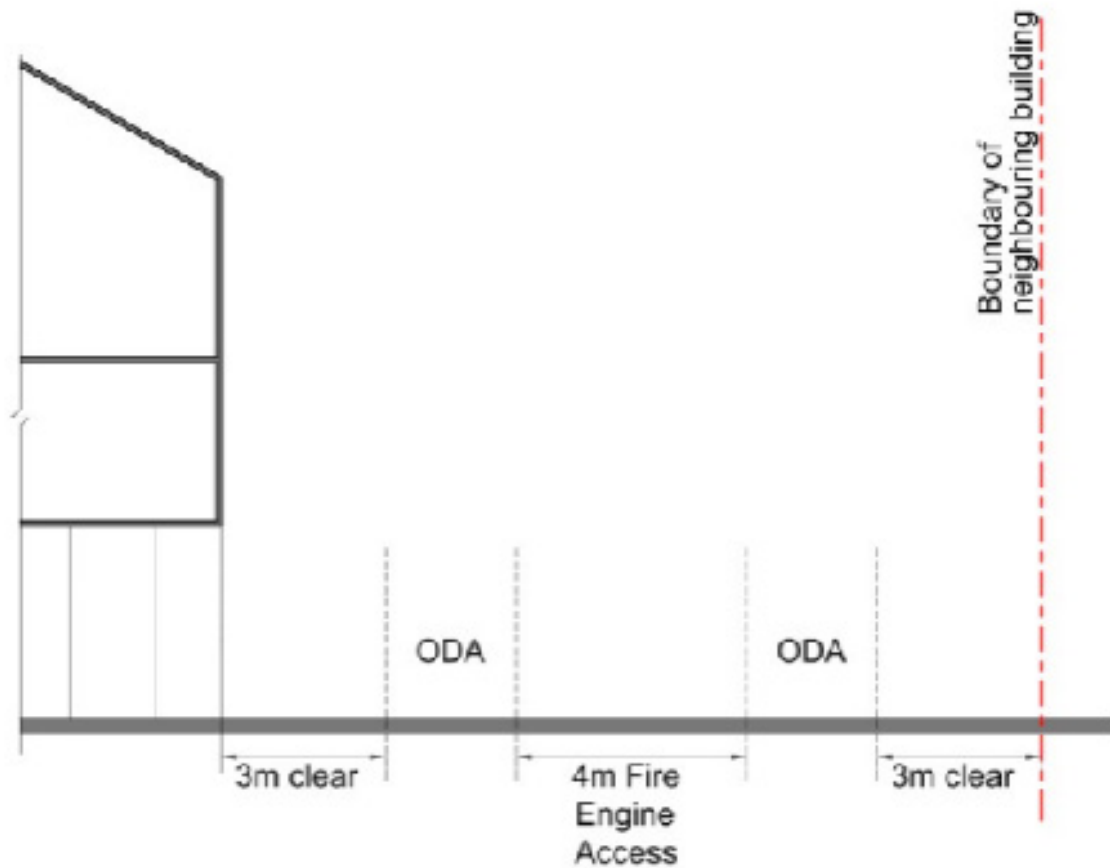

[Diagram 9.5.2b.\(1\) : Non-roofed-over ODAs detached from building](#)

The goods display area shall be located at least 3m from the roof eaves and/or boundaries of the neighbouring buildings.

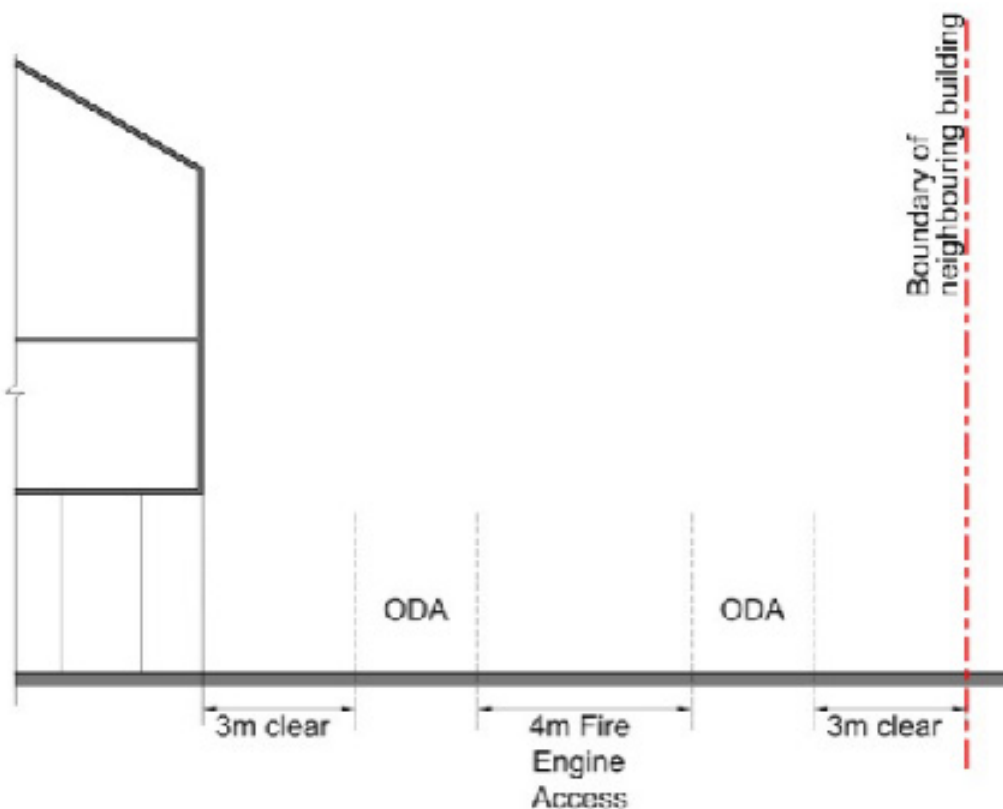

The goods display area shall be located at least 3m from the roof eaves and/ or boundaries of the neighbouring buildings



[Diagram 9.5.2b.\(2\) : Roofed-over ODAs detached from building](#)

The goods display area shall be located at least 3m from the roof eaves and/or boundaries of the neighbouring buildings.

The maximum total length of stalls shall not exceed 6m. A separation distance of at least 3m shall be provided between stalls if the total length exceeds 6m. However, the continuous length of stalls can exceed 6m if hose reel is provided to cover these stalls.

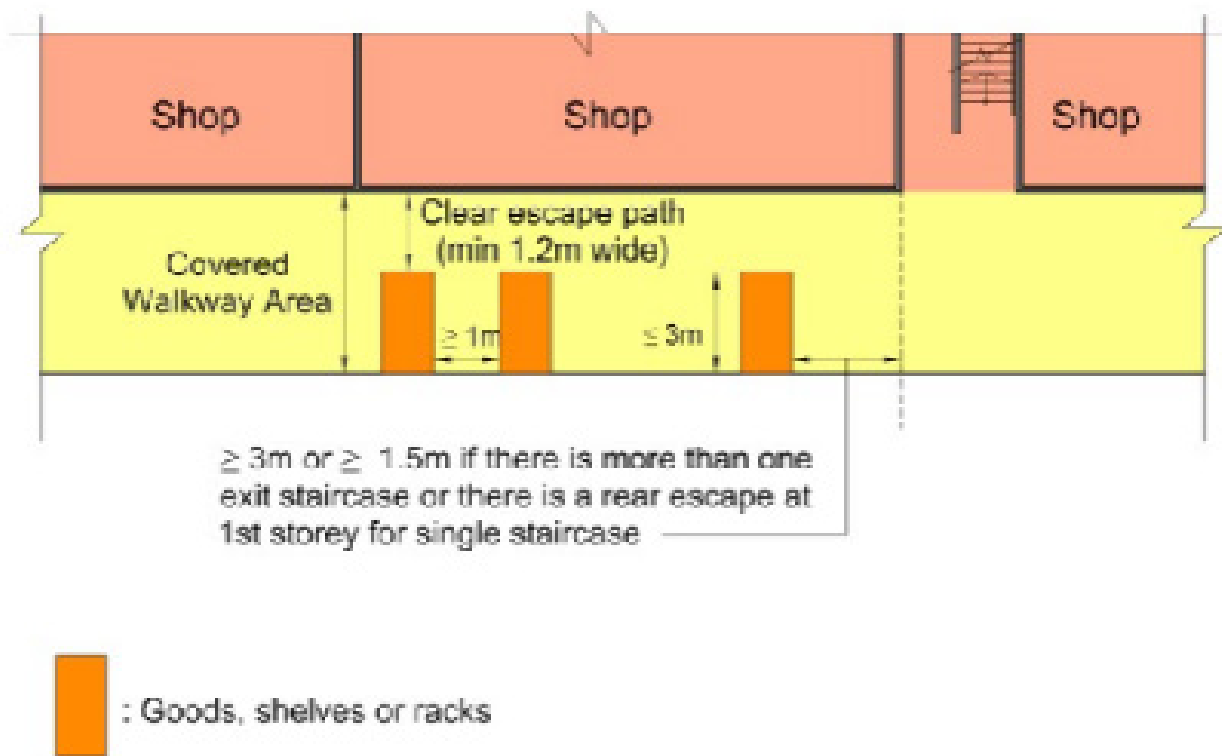

[Diagram 9.5.2b.\(3\) : ODAs along covered walkway](#)

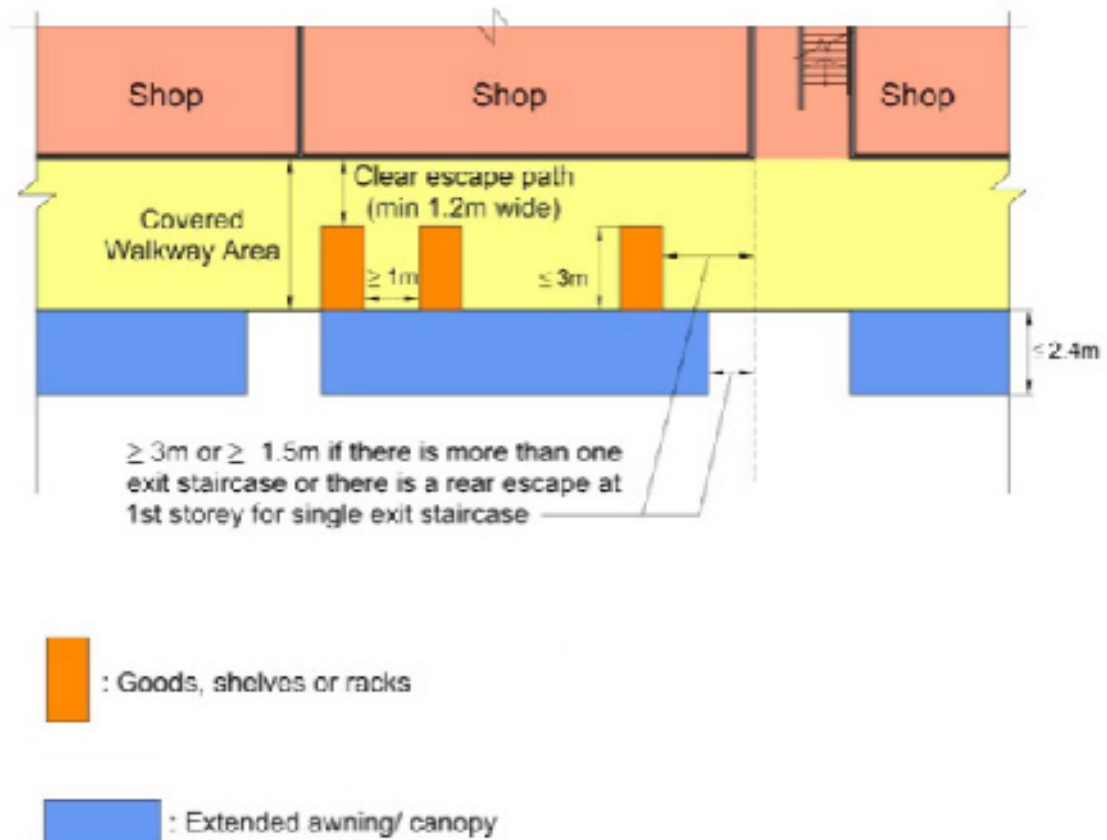

[Diagram 9.5.2b.\(4\) : ODAs underneath extended awning/canopy](#)

9.6 PURPOSE GROUP VI OCCUPANCY

9.6.1 General

a. Means of escape

(1) **Aboveground factory floors**

One exit staircase is permitted to serve an aboveground factory floor provided:

- (a) the habitable height of the floor does not exceed 15m;
- (b) the floor does not be located above 4th storey; and
- (c) the AFA of the floor does not exceed 200m².

(2) **Mezzanine floor**

One open staircase is allowed to serve a mezzanine floor(s) within an aboveground factory floor provided:

- (a) the aggregate AFA of the mezzanine floor(s) per factory unit does not exceed 60m²;
- (b) the open staircase has a width of at least 1m and be constructed of non-combustible materials;
- (c) the maximum travel distance measured from remote point on the mezzanine floor(s) to the exits complies with [Table 2.2A](#);
- (d) the elements of structure of the mezzanine floor(s) are of at least 1-hr fire resistance rating construction;
- (e) the habitable height of mezzanine floor does not exceed 24m; and
- (f) the mezzanine floor is only be used for store and/or ancillary office.

b. Structural fire precautions

Fire compartmentation between individual tenancy units within a terraced or flatted factory building shall be provided. The entire enclosure of each of these units shall be fire compartmented with walls and floors of at least 1-hr fire resistance rating.

9.6.2 Petroleum service stations

a. General

- (1) Any site chosen shall be sufficiently spacious for it to be designed to minimise unauthorised access, i.e. it shall be away from areas of high human traffic and the entrances/exits of other buildings.
- (2) The boundary line of petroleum service stations shall be at least 50m from any residential building, or 90m from any place of public assembly.

- (3) The route for tank vehicles leading to petroleum service stations shall not pass through or be near to places of public assembly, as stated in *Cl.9.6.2a.(2)*.
- (4) A service station shall be stand-alone, and dispensing of petrol shall be restricted to the ground level only (see *Diagram 9.6.2a.(4)*).
- (5) Convenience stores integrated with the petroleum service station shall be at most 150m².

b. Storage and tank requirements

- (1) Tanks for all classes of petroleum in a petroleum service station shall be installed underground.
- (2) All underground tanks shall have a water capacity of not more than 30kl each.

c. Tank requirements

The tank shall be designed, constructed, installed and tested to meet any of the following:

- (1) British Standards (BS 2594): Carbon Steel Welded Horizontal Cylindrical Storage Tanks, or
- (2) Underwriters Laboratories (UL 58): Steel Underground Tanks for Flammable and Combustible Liquids, or
- (3) Standards Association of Australia (1962): Steel Tanks for the Storage of Flammable and Combustible Liquids, or
- (4) NFPA 30, Flammable and Combustible Liquids Code, or
- (5) other equivalent standards.

d. Underground tanks and access pits

All underground tanks installations shall comply with the following requirements:

- (1) the road surface above the underground tanks shall be of reinforced concrete of the thickness necessary to support itself and any superimposed loads, but not less than 150mm;
- (2) the depth from the road surface to the top of the tank shall be not less than 450mm; and
- (3) each access pit shall be fitted with a cover that is watertight or raised above the level of the surrounding ground to prevent the entry of surface water, and be strong enough to withstand any superimposed loads. The strength of such a cover shall not be inferior to those of 5mm low carbon steel.

e. **Separation from property boundaries and building foundations**

The distance of the underground tank to any property boundaries and foundations shall be not less than 2.5m and 1m respectively (see *Diagram 9.6.2a.(4)*).

f. **Corrosion protection**

Any underground tank and its associated piping shall be protected from corrosion by one or more of the following methods:

- (1) protective coating or wrappings, or
- (2) cathodic protection, or
- (3) corrosion-resistant materials of construction.

g. **Venting**

Each tank shall incorporate a vent to atmosphere for the vapour space above the liquid to allow vapours to vent to the atmosphere.

h. **Vent capacity**

The size of any vent shall be such that pressure or vacuums resulting from filling, emptying or atmospheric temperature change, will not cause stresses in excess of the maximum design stress for the tank. The vent shall have a minimum internal diameter of 38mm.

i. **Vent piping**

Any vent piping between the tank vent connection and the discharge point shall comply with the following requirements (see *Diagram 9.6.2i*):

- (1) the vent pipes shall fall consistently back to the tank at a slope not less than 1 in 40;
- (2) a vent pipe shall not pass through building foundations, but can be embedded in concrete, which is part of other types of building construction. A vent shall not be run within a cavity wall but can pass through a cavity wall or through masonry which incorporates cavities, provided that it is in a sleeve which will prevent vapour gaining access to the cavities; and
- (3) a vent pipe can be either embedded in a concrete slab or laid in the earth. If the vent pipe is laid in the earth, it shall be:
 - (a) located not less than 300mm below ground level;
 - (b) surrounded by clean washed sand, or provided with equivalent corrosion protection;
 - (c) suitably protected if the area is subject to vehicular traffic;
 - (d) the vent pipe and its terminal shall be located or protected so that they are not liable to damage resulting from normal activities;

- (e) the vent pipe shall be vapour-tight throughout its length; and
- (f) all underground tanks or compartments in a tank shall have a separate individual vent pipe.

j. Vent outlet location

The discharge point of a vent shall comply with the following requirements:

- (1) the location, direction and velocity of discharge shall be such that venting vapour will not cause danger to the surroundings;
- (2) the vent discharge point shall be not less than 2m from any boundary or opening of a building, e.g. windows, doors, ventilators, air conditioners and forced air intakes (see *Diagram 9.6.2a.(4)*); and
- (3) the vent shall discharge into open air and vent discharge point shall be located not less than 4m above ground level (see *Diagram 9.6.2i.*).

k. Vent terminal

- (1) The discharge end of a vent shall be protected from the ingress of foreign material by a protective cage of fitting and shall discharge only vertically upward in order to disperse vapours.
- (2) A vent provision shall be connected to a vapour recovery or collection system, as similarly provided for at the filling mentioned in *Cl.9.6.2l.*

l. Filling connection

The filling connection to a storage tank, which is filled from a tank vehicle, shall incorporate a vapour-tight connection. A cap or cover with lock shall be provided for the filling point. A vapour recovery system shall be provided to prevent accumulation or abnormal discharge of vapour during refilling.

m. Location of filling point

The location of the filling point for any storage tank intended to be filled from a tank vehicle shall comply with the following requirements (see *Diagram 9.6.2a.(4)*):

- (1) the length of any hose required to connect a tank vehicle to the filling point shall not exceed 5m;
- (2) the filling point shall be protected from accidental or physical damage. Guardrails or any necessary measures shall be installed to prevent damage by collision;
- (3) the filling point for any tank containing Class I, Class II or Class III petroleum shall be in open air at least 3m from any building opening or boundary. If a distance of 3m cannot be complied with, a vapour barrier made of material of at least 2-hr fire resistance rating shall be installed and shall not be less than 500mm above the centre of the filling point inlet. The vapour barrier shall be at least 1m from the boundary line. The distance measured in a horizontal plane around the end of any vapour

barrier shall be 3m from the centre of the outermost filling point inlet to the building and boundary (See *Diagram 9.6.2a.(4)* for details);

- (4) the edge of the tank vehicle designated parking area for refilling shall be at least 3m from any building opening or boundary; and
- (5) the filling point for the underground tank shall be located in such a way that tank vehicles have unobstructed entry and egress from the service station.

n. Piping design suitability

The design, fabrication, assembly, test and inspection of piping shall be suitable for the expected working pressure temperatures and structural stresses and shall comply with relevant local (where available) or international standards.

o. Piping material suitability

Any material used in the construction or installation of piping shall be suitable for the conditions of use, and in particular:

- (1) it shall be compatible with the particular petroleum or any other component with which it may be in contact;
- (2) it shall be resistant to any heat (during operations) to which it may be exposed; and
- (3) it shall be corrosion-resistant.

p. Piping flexible tube

Flexible tubing, piping or hose can be used only on condition that:

- (1) the use of such tubing is unavoidable because of the need to provide for movement or to reduce the effect of vibration; and
- (2) the tubing is of flexible metallic, metal-reinforced, armoured or other construction suitable for the working pressure, temperature and the liquid being handled.

q. Piping design and construction

The following general design considerations shall be taken into account when designing or installing any piping:

- (1) the layout shall take into account the needs for all operating accesses and shall ensure that fire engine accessways are not impeded;
- (2) supports and fitting of the pipework shall be secure and the piping shall be not unduly exposed to mechanical damage;
- (3) wherever necessary, provision shall be made for the expansion or contraction of the piping and its contents;
- (4) any buried piping shall be protected from superimposed loads, ground settlement, etc.;

- (5) any necessary electrical bonding and earthing shall be provided; and
- (6) piping shall be painted and/or marked in a manner sufficient to facilitate identification of its contents.

r. Pump drive

Any motor or engine that drives a pump for use with any classes of petroleum shall be of the type specifically approved for such use.

s. Fuel dispensing system

- (1) Dispensing units at a service station shall be located in the open air where they will be adequately ventilated. These shall be located such that all parts of the vehicle being served will be on the premises of the service station, and shall be sited not less than 6m away from any building, public roadway or boundary (see *Diagram 9.6.2a.(4)*).
- (2) A clearly identified and easily accessible switch or circuit breaker (a centralised Emergency Shut-Off Device) shall be provided at a location remote from the dispensing devices, including remote pumping systems, to shut off the power to all dispensing devices in the event of an emergency, and shall not be less than 6m or more than 15m from the dispenser. A sign incorporating the wordings “EMERGENCY CUT-OFF” shall be provided in the vicinity of the cut-off switch (see *Diagram 9.6.2s.(2)*). A similar device shall be provided in close vicinity to the console area/cashier as stipulated in *Cl.9.6.2u.(1)*.
- (3) Petroleum shall be transferred from underground tanks by means of fixed pumps designed and equipped to allow control of the flow and to prevent leakage or accidental discharge.
- (4) A control shall be provided such that the pump will operate only when a dispensing nozzle is removed from its bracket or normal position with respect to the dispensing unit and the lever on this dispensing unit is manually activated. This control shall also stop the pump when all nozzles have been returned, either to their bracket or to the normal non-dispensing position.
- (5) The dispensing unit and its piping shall be mounted on a concrete island. Each island shall rise not less than 150mm above the surrounding ground level and shall extend not less than 300mm on both sides of the dispensing units and at least 500mm from the dispensing unit to the edge of the base measured longitudinally (see *Diagram 9.6.2s.(2)*).
- (6) The length of hose at each service station shall not exceed 5m. When not in use the hose shall be secured so as to protect it from damage.
- (7) The nozzle through which fuel is dispensed to a vehicle shall be designed to automatically close when the fuel tanks of the vehicles are full.
- (8) Individual dispensing units shall be provided with an emergency shut-off device.

- (9) A rigidly anchored emergency shutoff valve, incorporating a fusible link or other thermally activated device, designed to close automatically in the event of a severe impact or fire exposure, shall be properly installed in the supply line at the base or inlet of each dispenser. The automatic closing feature of this valve shall be checked at the time of initial installation, and at least once a year thereafter by manually tripping the hold-open linkage.

t. Remote pumping systems

For systems where petroleum is transferred from storage to individual or multiple dispensing units by pumps located other than at the dispensing units, the following requirements shall apply:

- (1) pumps shall be designed or equipped so that no part of the system will be subjected to pressure above its allowable working pressure;
- (2) pumps installed above grade level shall be located not less than 3m from the boundary or building opening, and shall be substantially anchored and protected against physical damage; and
- (3) pit lids or covers for subsurface pumps or piping manifolds of submersible pumps shall be in accordance with [Cl.9.6.2d.\(3\)](#).

u. Attended self-service stations

- (1) The dispensing area at all times shall be in clear view of the console area/cashier (area having control of the emergency shut-off devices for all and individual dispensing units, including remote pumping systems).
- (2) The console/cashier operator shall at all times be able to communicate with persons at the dispensing area. This can be by means of a voice communication system.
- (3) Sufficient close circuit cameras are to be installed at the petroleum service station to cover the forecourt, backcourt, dispensing areas and other critical areas of the petroleum service station.
- (4) Provisions must be made for bollards and chains to be installed at the exit and the entrance of the petroleum service station during refilling by the tank vehicle to be utilised during high alert situations.
- (5) The setback distance from the edge of the roof of the dispensing area to any boundary line must be in accordance to the requirements of [Cl.3.5.3](#), or 3m, whichever greater. (See [Diagram 9.6.2a.\(4\)](#))

v. Electrical equipment and area classification

All electrical wiring and equipment shall be of a type suitable for the location, in accordance with NFPA 70 or SS 254.

w. Caution labelling

An emergency information panel shall be provided at the filling point.

x. Warning signs

- (1) Warning signs shall be conspicuously displayed at the individual dispensing area incorporating the following wordings: "WARNING - NO SMOKING, NO NAKED LIGHTS, STOP ENGINE". The lettering shall be at least 50mm high.
- (2) The signs shall be displayed not less than 1.8m and not more than 2.5m above the ground level.

y. Firefighting and prevention**(1) Fire extinguishers**

Approved types of fire extinguishers of rating not less than 70B (9kg) or 34B (2 x 4.5kg) shall be provided at the individual dispensing units and protected from the weather.

(2) Hose reels

- (a) Sufficient hose reel coverage shall be provided such that the service station usable/accessible area is within 6m of a nozzle attached to a 30m hose.
- (b) Hose reels shall comply with the requirements of SS 575.

(3) Absorbents

A small quantity of absorbent material or sand (as a guide, one full bucket minimum of 40 litres) shall be provided at the service station to mop up any spillage. These absorbent materials shall be kept in a container with a close fitting lid and shall be installed in an accessible place.

(4) Fire hydrant

Fire hydrants shall be within 50m from any part of the fire engine access road. The actual travel distance from the edge of the fire engine access road to the most remote point of the petroleum service station usable/accessible space shall not be more than 50m.

9.6.3 High containment facilities**a. General**

The purpose of this section of the Code is to stipulate fire safety requirements for high containment facilities and laboratories that handle biological agents or toxins, which are designed to meet the requirements of WHO and the authority having jurisdiction for Bio-Safety Level 3 (BSL-3) or higher.

b. General requirements

- (1) A BSL-3 or BSL-4 containment laboratory shall be located at the ground floor and shall be separated from areas that are open to unrestricted traffic flow within the building. They shall be designed and constructed to comply with the requirements listed herein.

- (2) The word “BSL-3” or “BSL-4” shall be stated clearly in the project title and printed on the top-right corner (lettering shall be bold, in red colour and at least 15mm in size) of all the fire safety plans of the high containment facility.

c. Fire compartment

- (1) In a sprinkler-protected building, the high containment facility (including interstitial space, waste treatment areas, anterooms, etc.) shall be fire compartmented from adjoining spaces with at least 1-hr fire-rated walls, floor and ceiling. For a non-sprinkler-protected building, the fire rating shall be at least 2 hours.
- (2) The protecting structure shall be constructed of masonry or drywall. If drywall construction is used, it shall be in accordance with *Cl.3.8.7b.*

d. Firefighter staging lobby

For high containment facilities, an additional (on top of the usual requirement to have a fire lift lobby next to exit staircases) firefighter staging lobby shall be provided to comply with the following requirements:

- (1) it shall be located at every entrance of the facility;
- (2) it shall be fire-compartmented with at least 1-hr fire resistance rating;
- (3) in the absence of (1), an anteroom with the same fire resistance rating shall be provided to serve this function;
- (4) it shall have at least 6m² free working space;
- (5) it shall comply fully with *Cl.2.2.13b.(1) to (6), (7)(a) and (b)*; and
- (6) it shall be installed with designated main landing valve, standby fire hose and fire hose reel.

e. Two-way emergency communication system

For a biomedical facility or building provided with a two-way emergency voice communication system, the two-way emergency communication system shall be extended to the firefighter staging lobby.

f. Fire detection and suppression systems

All high containment facilities shall be protected with sprinkler systems. High containment facilities without sprinkler protection shall comply with the following:

- (1) smoke detectors shall be installed along the exterior of the periphery walls of the high containment facility;
- (2) the fire protection circuit for BSL-3 or BSL-4 shall be grouped in a different fire zone for ease of identification;
- (3) the fire protection systems shall be linked to the building fire alarm

system and shall be connected to the SCDF Operations Centre through an approved alarm monitoring company; and

- (4) if water discharge within the high containment facility is undesirable or unacceptable, the sprinkler system can be replaced by an approved fire extinguishing system.

g. Label and sign

- (1) Caution labels shall be provided at all the laboratory entrances and exits in accordance with SS 586. In addition, a label indicating the information as shown in *Diagram 9.6.3g.(1)* shall be also provided.
- (2) A sign shall be displayed at all entrances to the high containment facility, with the following wording: “In the event of fire or any water discharge, please notify PUB at 1800-2846600 for control of contaminated water runoff.”

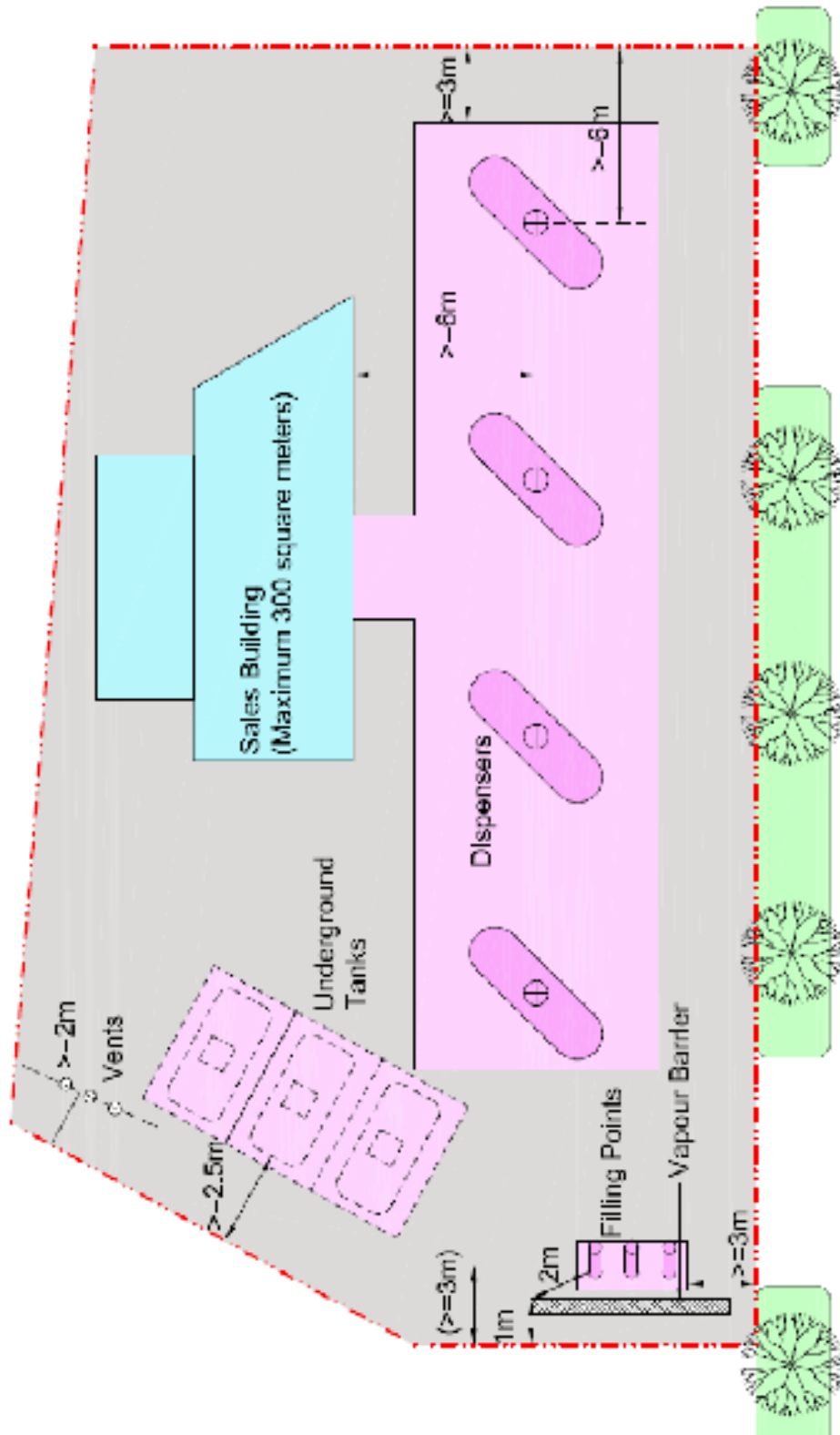

[Diagram 9.6.2a.\(4\) : Typical petroleum service station](#)

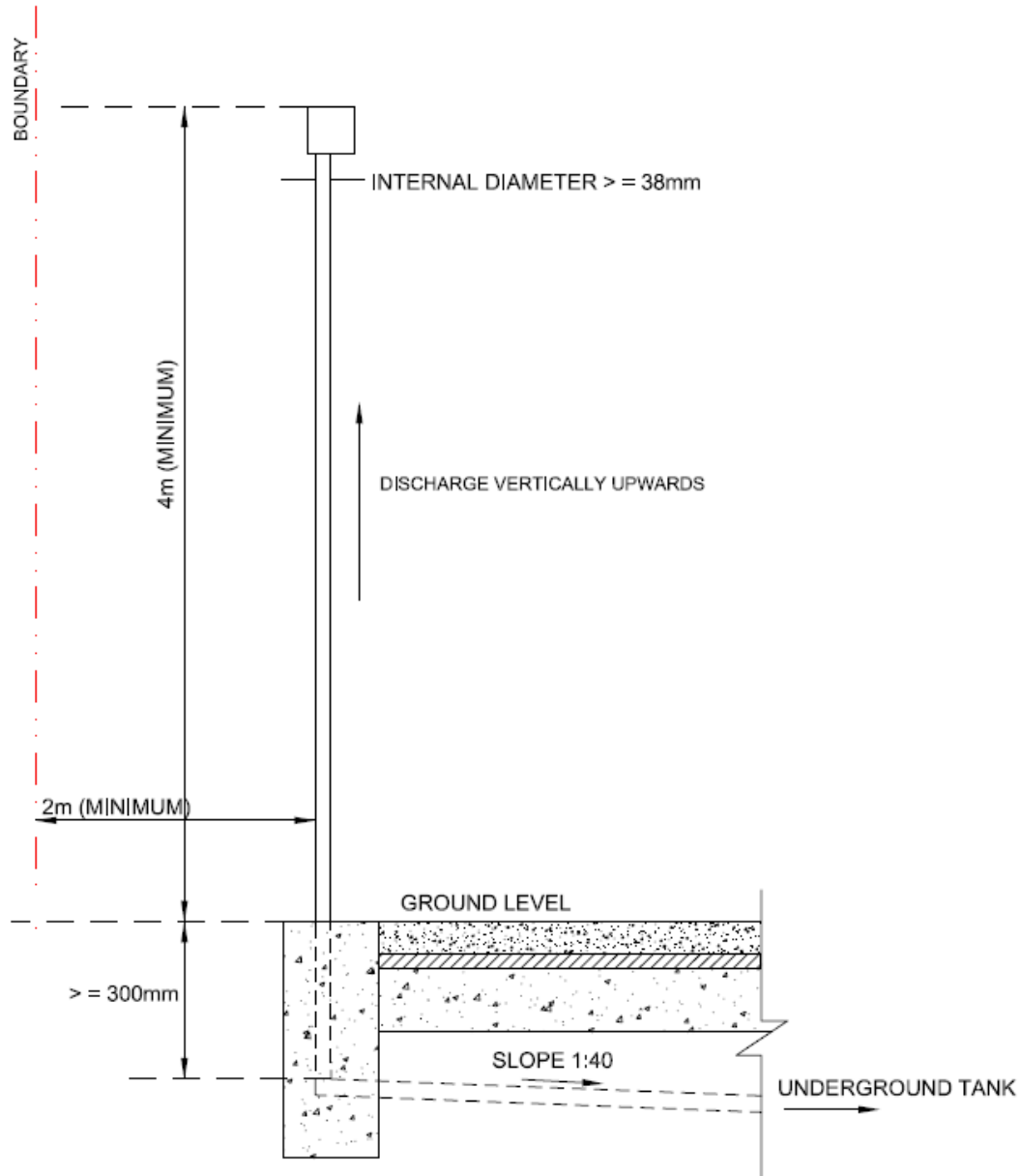

[Diagram 9.6.2i : Vent](#)

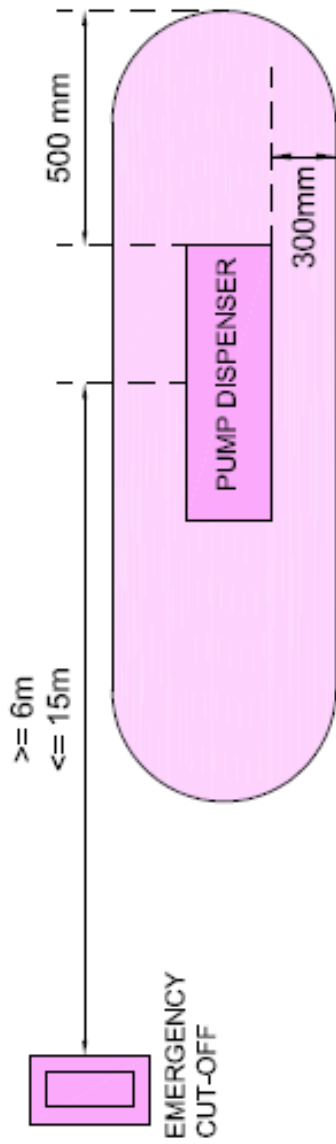

Plan

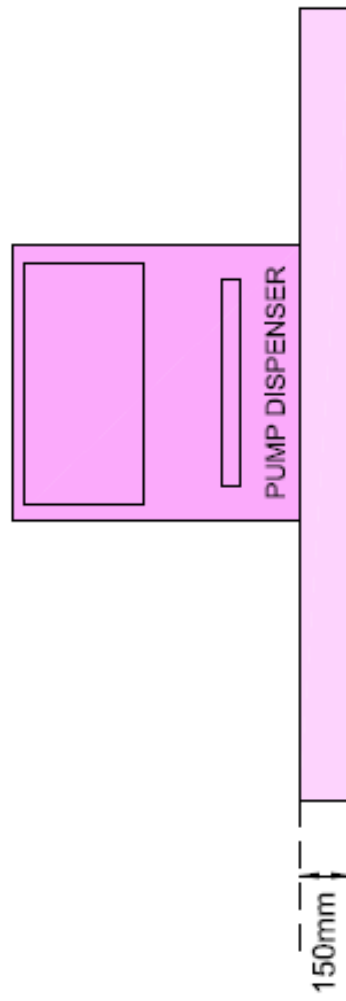

Elevation

[Diagram 9.6.2s.\(2\) : Pump island](#)



BIOHAZARD

1000-04-04

ADMITTANCE TO AUTHORIZED PERSONNEL ONLY

Biosafety Level:

Responsible Investigator: _____

In case of emergency call: _____

Daytime phone: _____ **Home phone:** _____

**Authorization for entrance must be obtained from
the Responsible Investigator named above.**

[Diagram 9.6.3g.\(1\) : Biohazard caution label](#)

9.7 PURPOSE GROUP VII OCCUPANCY

9.7.1 General

(Not in use)

9.7.2 Hotels, boarding houses, serviced apartments, hostels & backpacker hotels

a. Access through an internal corridor

Guestrooms or accommodation units with access through an internal corridor shall comply with all of the following requirements:

- (1) Each guestroom or accommodation unit shall be compartmented from adjoining rooms and other parts of the same building, including the internal corridor, by construction having fire resistance rating of at least 1 hour.
- (2) Doors opening into internal corridors shall have fire resistance of at least half an hour and fitted with automatic self-closing device to comply with the requirements of *Cl.3.9.2*.
- (3) The common internal corridor shall have ventilation openings of not less than 15% of the floor area and located not more than 9m from any part of the common internal corridor. Internal corridors which cannot be naturally ventilated shall be pressurised to comply with the requirements in Chapter 7.
- (4) Other rooms or spaces which open into or form part of the guestroom or accommodation unit corridor which can jeopardise the means of escape shall be required to be compartmented to the same extent as the guestroom or accommodation unit.

b. Access through an external corridor

Guestrooms or accommodation units with access through an external corridor shall comply with all of the following requirements:

- (1) Each guestroom or accommodation unit shall be compartmented from adjoining rooms and other parts of the same building by construction having fire resistance rating of at least 1 hour, unless otherwise permitted under *Cl.2.3.10* for the provision of window openings between the guestroom or accommodation unit and external corridor.
- (2) Doors opening into the external corridor need not have fire resistance rating.
- (3) The external corridor shall comply with *Cl.2.3.10*.

c. Measurement of travel distance

The travel distance shall be measured from the most remote point of a guestroom or accommodation unit or suite to the exit door of an exit staircase, exit passageway or external space.

d. Spacing of smoke barrier

- (1) Internal corridors which are not naturally-ventilated shall be subdivided by smoke barriers into the following lengths:
 - (a) Building protected by sprinkler system - 45m, or
 - (b) Building not protected by sprinkler system - 30m
- (2) Smoke barriers shall comply with all of the following requirements:
 - (a) The smoke barriers shall consist of non-combustible partitions containing smoke check doors. The smoke barriers, including the enclosing walls to the corridor, shall be constructed to full height, carried right up to form a close joint with the soffit of the floor slab above, or an imperforate non-combustible ceiling or the roof coverings.
 - (b) The smoke barriers shall be sited at suitable locations across the corridor to create multiple sections, with each having free and direct access to an exit or exit staircase, exit passageway or exit ramp.
 - (c) Smoke-check doors excluding glass doors, shall be provided with clear glass vision panels having at least 25% of the surface area of each door leaf.
 - (d) Smoke-check doors shall be of the self-closing, swinging type. Double swing type is permitted provided that the door opening is closed completely with such clearance as is reasonably necessary for proper operation. The doors shall be closely fitted around their edges and the bottom clearance gap between such doors and the floor shall not exceed 4mm.
 - (e) Smoke-check doors shall normally be in the closed position. However, they can be left open if they are arranged to close automatically by an approved electromagnetic or electromechanical device which can be activated by the presence of smoke and/or the building fire alarm system.

e. Visual alarm system

At least 10% of the guestrooms or accommodation units shall be provided with visual alarms.

9.7.3 Assembly occupancy**a. General**

Number and minimum width of exits for assembly occupancies shall comply with the provisions tabulated as follows:

TABLE 9.7.3a. : MINIMUM WIDTH OF EXITS FOR ASSEMBLY OCCUPANCIES		
No. of Occupants	Min No. of Doors	Min width of corridors
51 - 200	2	1.20m
201 - 500	2	1.25m
501 - 1000	3	1.25m
exceeding 1000	4	1.25m

b. **Assembly occupancy with fixed seating (Performance theatres, Cinemas, Auditoriums, Concert Halls, etc.)**

(1) **Aisles and gangways**

- (a) clear aisles or gangways of not less than the minimum width of corridors shall be provided around the auditorium, stalls and balconies leading to doors or exit doors;
- (b) aisles or gangways shall be provided with intersecting rows of seating and the number of seats in a row shall be in accordance with the provisions tabulated as follows:

TABLE 9.7.3b.(1)(b) : NUMBER OF SEATS IN A ROW		
Seatway width mm	Maximum no. of seats in a row	
	Gangway on one side	Gangway on two sides
300 - 324	7	14
325 - 349	8	16
350 - 374	9	18
375 - 399	10	20
400 - 424	11	22
425 - 449	12	24
450 - 474	12	26
475 - 499	12	28
500 or more	12	Limited by the travel distance

The seatway shall be the minimum clear width between rows, which shall not be less than 300mm, measured as the clear horizontal distance from the back of the row ahead (including seats that tip up automatically) and the nearest projection of the row behind when the seats are in upright position. The seatway widths shall be constant throughout the length of the row. (See *Diagram 9.7.3b.(1)(b) - 1 and 2*)

- (c) for changes of level, steps shall not be used to overcome differences in level in aisles or gangways unless the slope of such gangways exceeds 1 in 10;
- (d) handrails shall be provided, where steps of a pitch exceeding 30° or ramps of a slope exceeding 1 in 10 are provided in aisles or

gangways flanking the seating;

- (e) flooring for the surface of steps and ramps forming the aisles or gangways shall be finished using non-slip materials; and
- (f) illumination of steps shall be such that each step is clearly visible in the event of emergency.
- (g) Combustible seats for cinemas, theatre, auditorium, etc.

The construction of combustible upholstered seats in cinema, theatre, auditorium, etc. shall comply with BS 5852 in respect of the following testing standard:

- (i) Smouldering Ignition Source;
- (ii) Flaming Ignition Source 1; and
- (iii) Crib Ignition Source 5.

(2) Exits from a theatre, cinema or a concert hall

- (a) The number and capacity of exits from an enclosed space in an assembly occupancy used or intended for use as cinema, concert hall, auditorium, performance theatre that is not normally provided with natural ventilation and lighting, shall be provided its own means of escape without having to take into account exits provided for its adjoining parts of the same building in which it is housed. Exception can be permitted where the occupant load does not exceed 200 persons, in which case at least half the capacity of exits shall be provided within the compartment.
- (b) Where a building or part of a building is designed as a cineplex to house multiple mini-cinemas, the means of escape to be provided can be shared by all the mini-cinemas. Each cineplex shall be treated as a single big cinema for the purpose of determining the exit requirements under *Cl.9.7.3b.(2)*.
- (c) The exits adjacent or attached to cinema, theatre or concert hall and the like can be shared as exits with the other parts of the building, provided the exits are accessible from the common circulation areas. The occupant load of the cinema, theatre, concert hall and the like does not exceed 200 persons.

(3) Separation of theatre, cinema or concert hall from other parts of the building

A theatre, cinema or concert hall shall be separated from other parts of the same building, which is of a different purpose group, by compartment walls and floors having a fire resistance rating of at least 2 hours. If the building is protected by an automatic sprinkler system, the fire resistance rating of the compartment walls or floors can be reduced to 1 hour. Where

openings are provided for access between the theatre, cinema or concert hall and any other part of the same building of a different purpose group, the openings shall either be protected by fire doors having the necessary fire resistance rating as the enclosing walls or floors, or be provided with lobby which complies with the following requirements:

- (a) The lobby is enclosed by walls having fire resistance rating of at least 1 hour, is naturally ventilated complying with the requirements for ventilation of smoke-stop lobbies, or mechanically ventilated to comply with the requirements in Chapter 7; and
- (b) All doors to the lobby shall each have fire resistance rating of at least ½ hour and fitted with an automatic self-closing device.

(4) Separation by proscenium wall in theatres or concert halls

- (a) In a place of public resort, such as theatres, and concert halls, capable of seating more than 500 persons and in which fly tower is used for stage scenery or when extensive stage scenery is installed on the stage side, the stage shall be separated from the seating area by a proscenium wall of at least 1-hr fire resistance rating in such a way that the stage and the audience seating area form separate compartments.
- (b) The entire stage side of the proscenium wall shall be fitted with an automatic sprinkler system which complies with the requirements in Chapter 6.
- (c) The proscenium opening shall be protected by fire curtain with fire resistance rating of at least 1 hour, automatically operated by a fusible link or a smoke detector. In lieu of fire curtain, a smoke curtain is acceptable, if engineered smoke control and automatic sprinkler systems are to be provided to the stage area.
- (d) Not more than three other openings can be provided in the proscenium wall. Such openings shall not exceed 2m² in area and shall be fitted with doors having fire resistance rating of at least ½ hour and fitted with an automatic self-closing device.

(5) Smoke control system

- (a) Multi-tier/level seating auditorium shall be protected by an automatic sprinkler system and engineered smoke control system. For single tier/level seating auditorium that is either sprinkler-protected or non sprinkler-protected, smoke vents complying with the following criteria can be provided in lieu of engineered smoke control system:
 - (i) at least 2.5% of the floor area;
 - (ii) at least 600mm X 600mm in size;

- (iii) adequately distributed such that no part of the auditorium is more than 12m from any ventilation opening;
 - (iv) located at high level close to soffit of the ceiling or within a perforated ceiling space; and
 - (v) activated by automatic device.
- (b) Exception:
- Lecture theatres and the like are exempted from the requirement to provide smoke vents, provided they fulfil all of the following criteria:
- (i) without stage curtain, fly tower, props, and back stage areas;
 - (ii) used solely for the conduct of lessons;
 - (iii) not located below ground level; and
 - (iv) not exceeding 5000m² in size.

9.7.4 Outdoor Refreshment Areas (ORAs)

a. General

- (1) This set of fire safety requirements shall be applicable to all food and beverage (F&B) outlets where ORAs are permitted by the authority have jurisdiction. F&B outlets shall include eating houses, restaurants, coffee shops, hawker centres, fast food outlets, cafeterias, canteens, pubs, bars and the like.
- (2) The total occupant load within each F&B outlet shall not exceed 200 persons. Where the limit is exceeded, alternate rear exit opening directly into a back lane or safe external space shall be provided.
- (3) Where an ORA encroaches on neighbouring property(s) or state land, it is the responsibility of the F&B's owner/operator to seek no objection from the property owner(s) for the setting up of the ORA on his property.

b. Fire safety requirements for ORAs

(1) ORAs along covered walkway

- (a) A five-foot way of width not less than 1.2m shall be provided along the covered walkway. Tables and chairs shall be abutting the F&B shop front or located at the outer edge of the building within the covered walkway. The entrance of the F&B outlet shall not be blocked.
- (b) For F&B outlet located next to an exit staircase, a clear escape path from the staircase discharge point to external space shall be maintained. The width of the escape path shall not be less than the width of the exit staircase. No table(s), chair(s) or any form of obstruction shall encroach onto this escape path at all times.

(See *Diagram 9.7.4b.(1)*)

(2) ORAs open to the sky

- (a) There is no limit to the number of table(s) or chair(s) placed in areas open to the sky, subject to compliance to other authorities having jurisdiction.
- (b) When placement of table(s) or chair(s) is extended to any covered walkway, the requirements stipulated under *CI.9.7.4b.(1)* shall be complied with.
- (c) There is no control on the size/height of the ODAs and the materials used for displaying goods at the ODAs. There shall be no encroachment of table(s), chair(s) or any form of obstruction on the escape path from the exit staircase discharge point to external space. The portion of covered ORAs beyond the building lines and abutting the escape path shall be demarcated from the escape path with a red colour line of width not less than 50mm. Red colour wordings, "NO OBSTRUCTION OF EXIT", of height not less

than 100mm shall be marked along the line at regular intervals of not more than 1.5m.

(See *Diagram 9.7.4b.(2)*)

(3) ORA with umbrellas

- (a) When umbrellas are used to provide shelter for diners, its size shall not be larger than 2m in diameter or 2m x 2m. The umbrellas shall be placed at a distance of not less than 1.5m from the building line (eaves of building).
- (b) There shall be no limit on the number of umbrellas placed in areas open to the sky. A separation distance of not less than 1.5m shall be provided between rows of umbrella. There shall be no roofing between rows of umbrellas.
- (c) Where placement of table(s), chair(s) or any form of obstruction is extended to any covered walkway, the requirements stipulated under *Cl.9.7.4b.(1)* shall be complied with.
- (d) There shall be no encroachment of table(s), chair(s) or umbrella(s) or any form of obstruction on the escape path from the exit staircase discharge point to external space. Where umbrellas are placed close to the exit staircase discharge path, *Cl.9.7.4b.(2)(c)* shall be complied with.
- (e) Umbrella having dimensions larger than 2m in diameter or 2m x 2m shall be treated as canopy/awning. Hence, requirements stipulated under *Cl.9.7.4b.(4)* shall be complied with.

(See *Diagram 9.7.4b.(3)*)

(4) ORAs with canopy/awning

- (a) There shall be no encroachment of table(s) or chair(s) or any form of obstruction onto the escape path from the exit staircase discharge point to the external space. This path beyond the building façade shall be clearly demarcated as per *Cl.9.7.4b.(2)(c)*.
- (b) For canopy/awning with projection not exceeding 1m
 - (i) No separation between the canopy/awning and the nearer edge of the exit staircase discharge path is required.
 - (ii) The high/low separation requirements stipulated under *Cl.3.5.7* need not be complied with.
 - (iii) The requirements on set back of unprotected openings from building/notional boundary stipulated under *Cl.3.5.3* need not be complied with.
 - (iv) Placement of table(s) or chair(s) beneath the canopy/awning is permitted.

- (v) The canopy/awning can be continuous and cover the exit staircase discharge path. Separation between the canopy/awning of the F&B outlet and those of the neighbouring units is not required.
- (vi) There shall be no control on the material of the canopy/awning.

(See *Diagram 9.7.4b.(4)(b)*)

(c) For canopy/awning with projection greater than 1m but not exceeding 2m

- (i) A minimum separation distance of 500mm between the canopy/awning and the nearer edge of the exit staircase discharge path shall be maintained and shall only be exempted if the awning/canopy is designed to retract automatically when fire/smoke is detected within the F&B unit or its ORA.
- (ii) The high/low separation requirements stipulated under [CI.3.5.7](#) shall be complied with.
- (iii) The requirements on set back of unprotected openings from building/notional boundary stipulated under [CI.3.5.3](#) shall be complied with.
- (iv) At least 500mm separation distance shall be maintained between the canopy/awning of the F&B outlet and the projection line of the separating wall and shall only be exempted if the awning/canopy is designed to retract automatically when fire/smoke is detected within the F&B unit or its ORA.
- (v) For auto-retractable canopy/awning as mentioned in [CI.9.7.4b.\(4\)\(c\)\(i\)](#), the canopy/awning can be continuous and cover the exit staircase discharge path and separation between the canopy/awning of the F&B outlet and those of the neighbouring units is not required.
- (vi) The surface flame spread rating of the canopy/awning shall be at least Class 2.

(See *Diagram 9.7.4b.(4)(c) - 1 & 2*)

(d) For canopy/awning with projection greater than 2m but not exceeding 3m

- (i) A minimum separation distance of 500mm between the canopy/awning and the nearer edge of the exit staircase discharge path shall be maintained.
- (ii) The high/low separation requirements stipulated in [CI.3.5.7](#)

shall be complied with.

- (iii) The requirement on set back of unprotected openings from building/notional boundary stipulated under *CI.3.5.3* shall be complied with.
- (iv) At least 500mm separation distance shall be maintained between the canopy/awning of the F&B outlet and the projection line of the separating wall.
- (v) The surface flame spread rating of the canopy/awning shall be at least Class 1.

(See *Diagram 9.7.4b.(4)(d)*)

(e) For canopy/awning with projection exceeding 3m

All relevant requirements stipulated in this Code shall be complied with.

(5) Other fire safety requirements

- (a) There shall be no open-flame cooking in ORAs, except those open to the sky.
- (b) For buildings which are installed with automatic fire sprinkler system, the sprinkler protection shall be extended to protected the covered ORAs.
- (c) Every part of covered ORAs shall be within the coverage of fire hose reel(s).
- (d) Approval of fire safety plans.

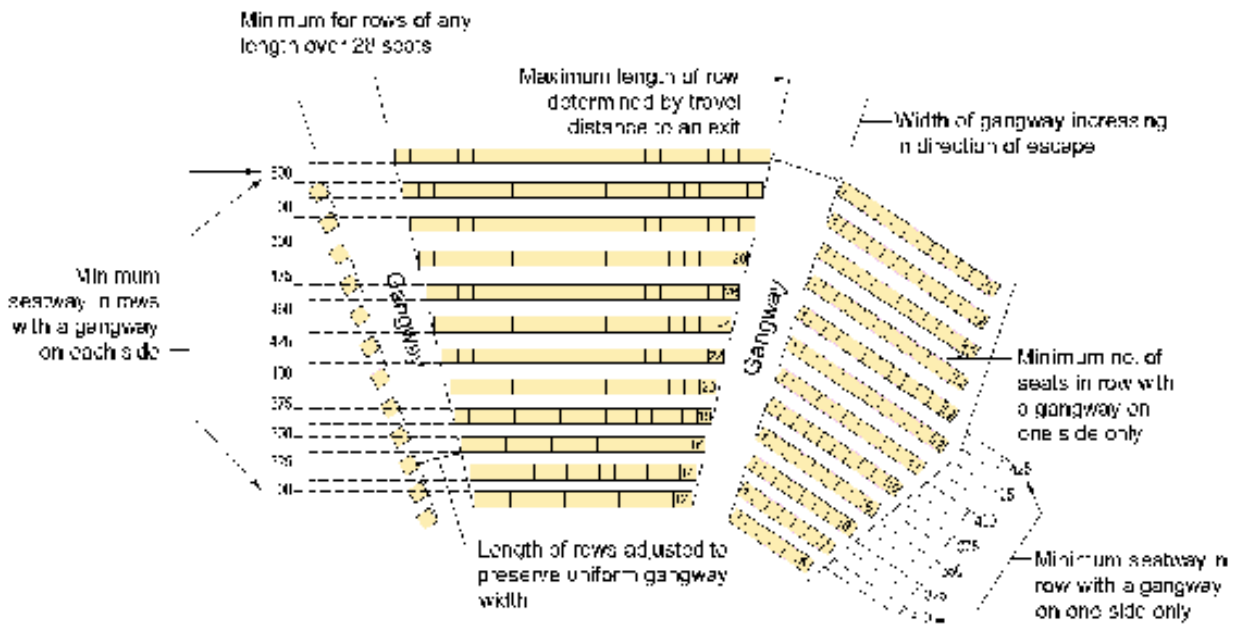

[Diagram 9.7.3b.\(1\)\(b\) - 1 : Seatway width and number of seats in a row](#)

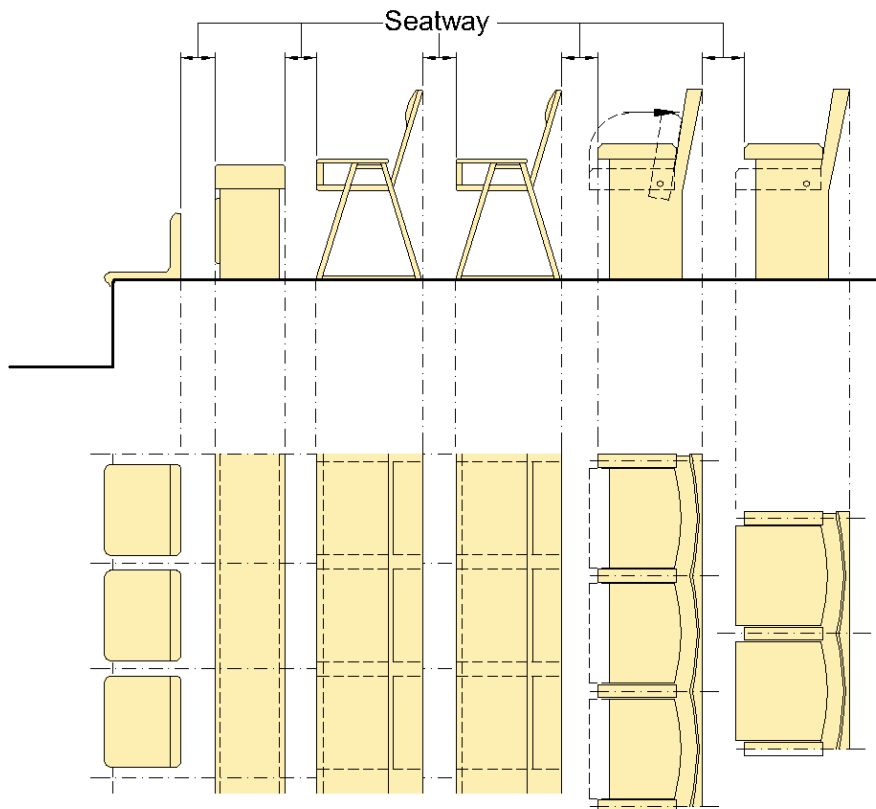

Seatway widths shall not be less than 300mm and shall be constant throughout the length of the row.

[Diagram 9.7.3b.\(1\)\(b\) - 2 : Determination of seatway width](#)

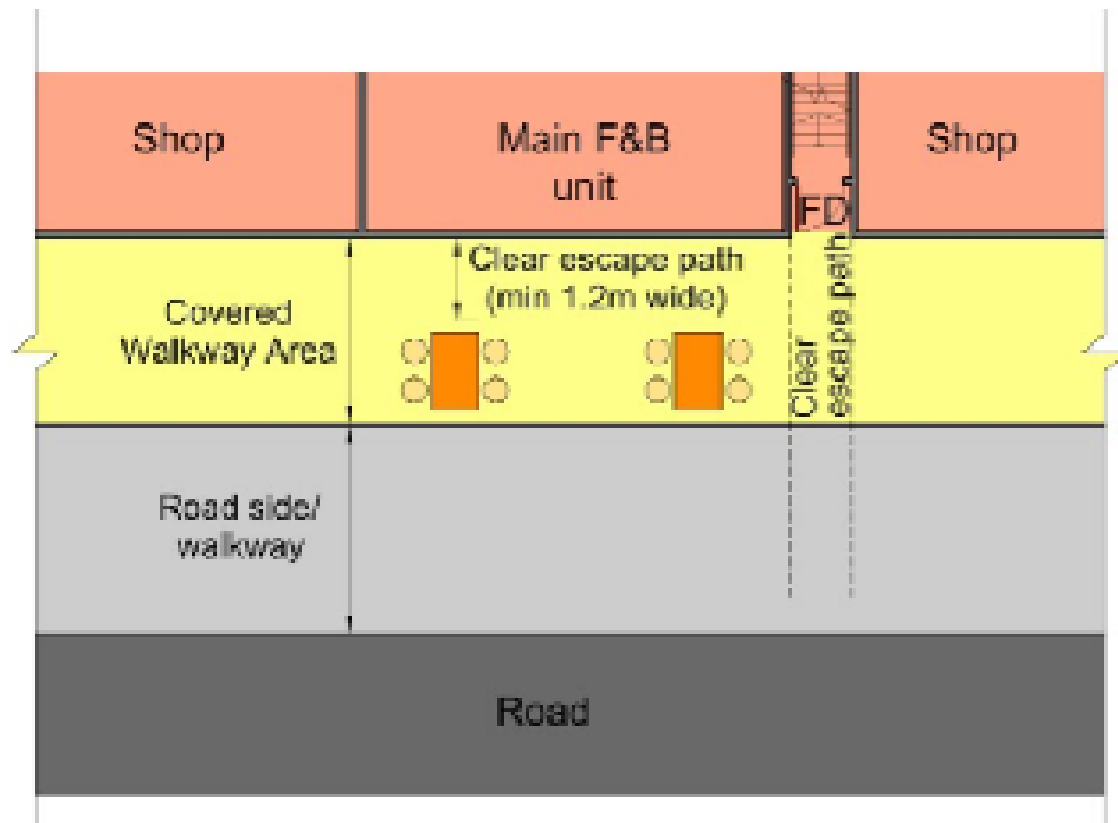

Plan view

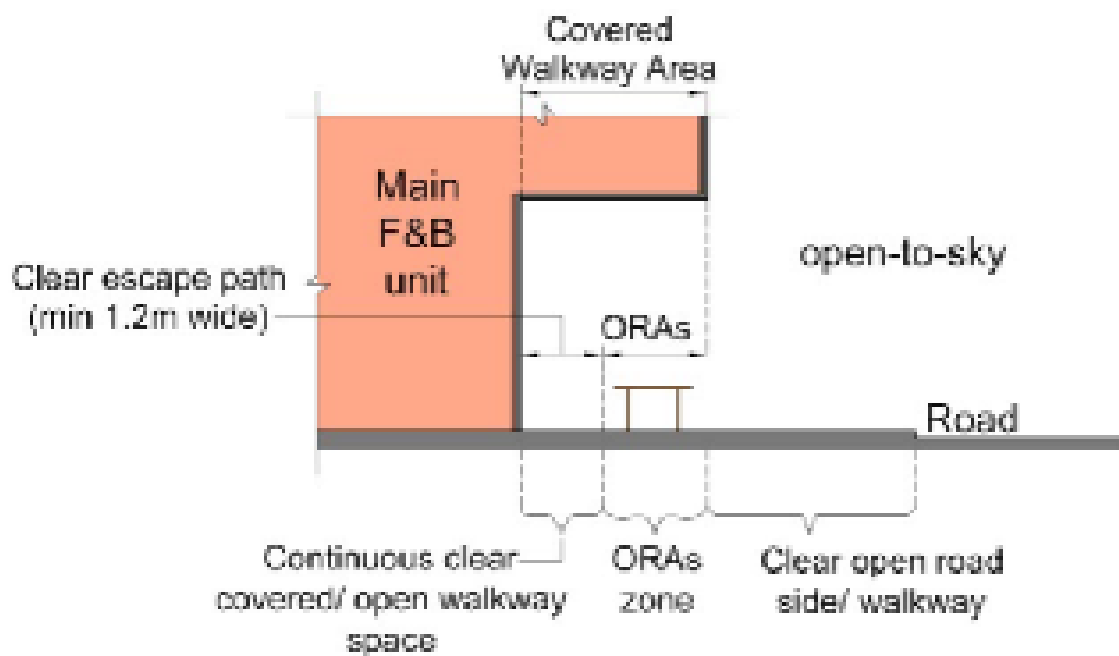

Cross sectional view

[Diagram 9.7.4b.\(1\) : ORAs along covered walkway](#)

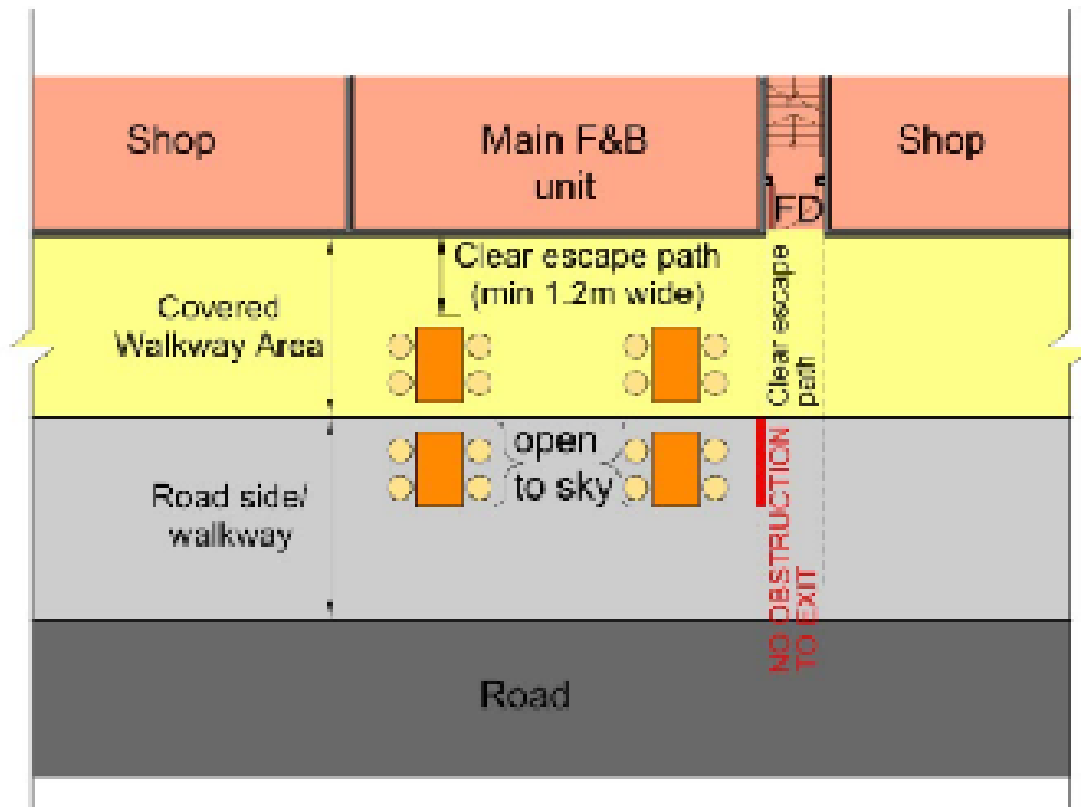

Plan view

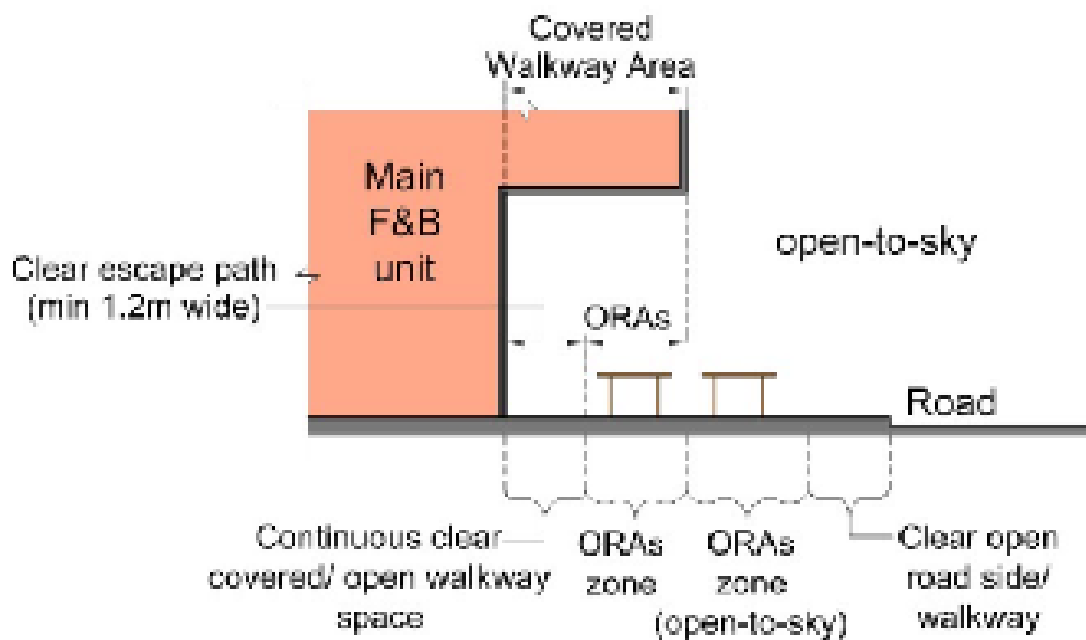

Cross sectional view

[Diagram 9.7.4b.\(2\) : ORAs open to sky](#)

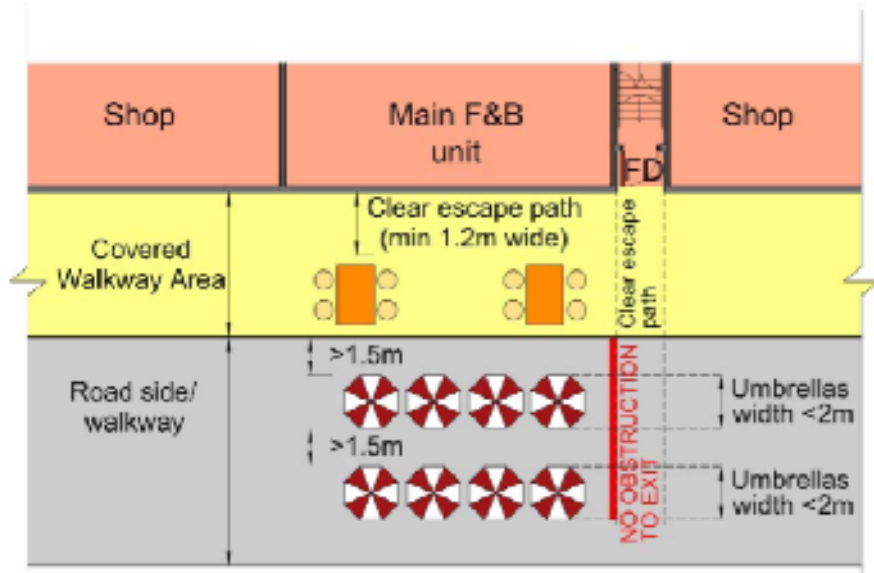

Plan view

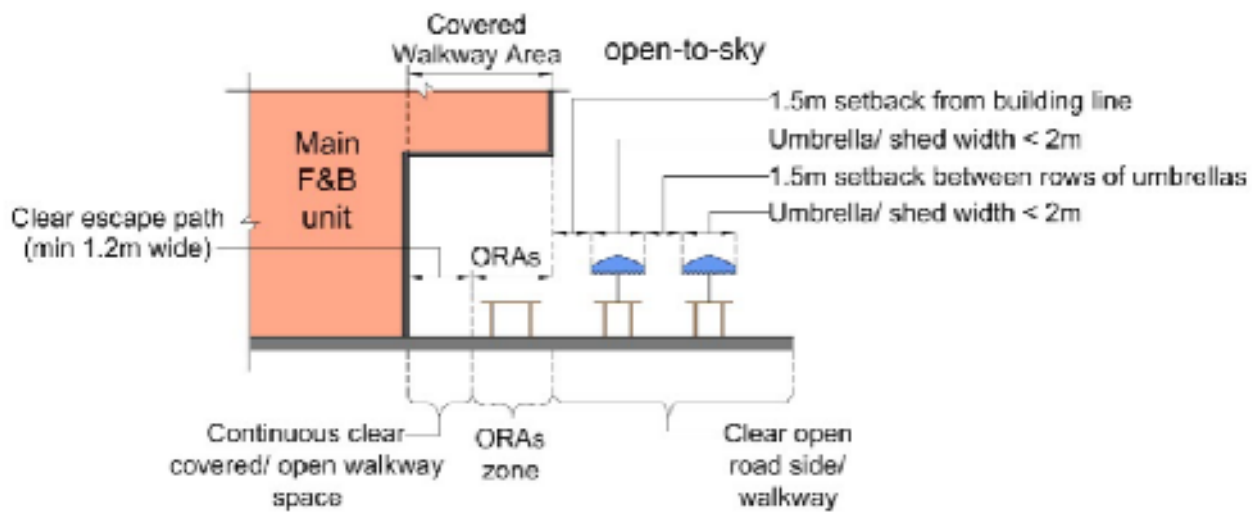

Cross sectional view

[Diagram 9.7.4b.\(3\) : ORAs with umbrella](#)

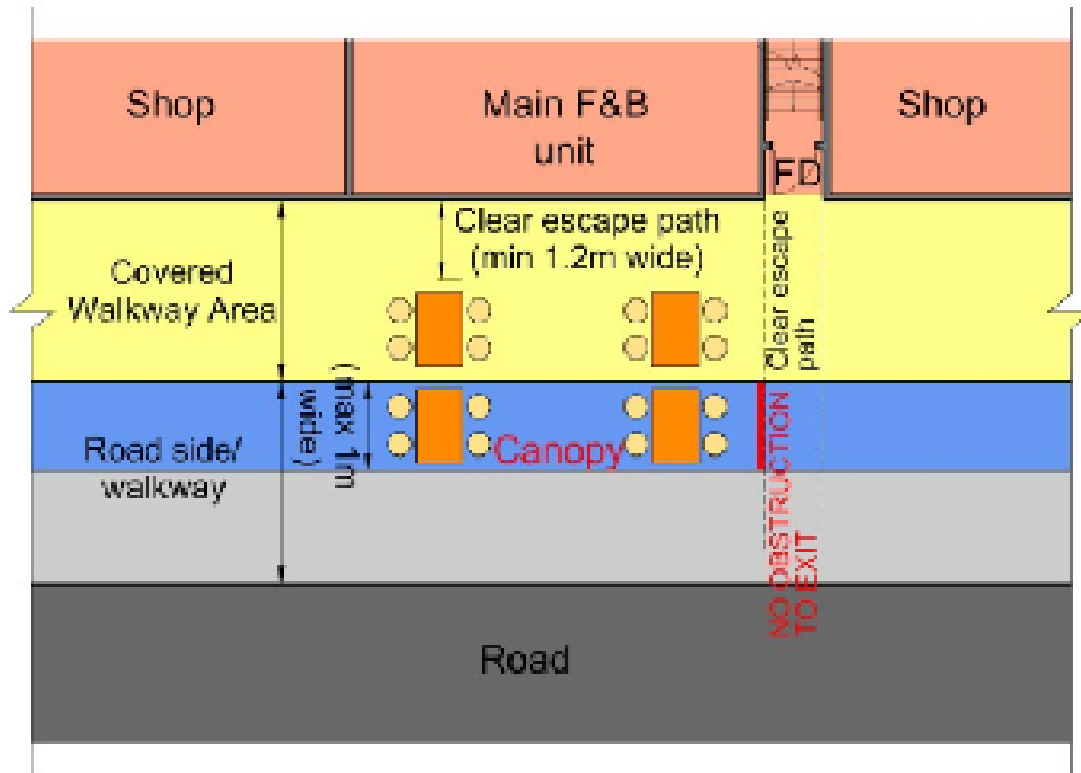

Plan view

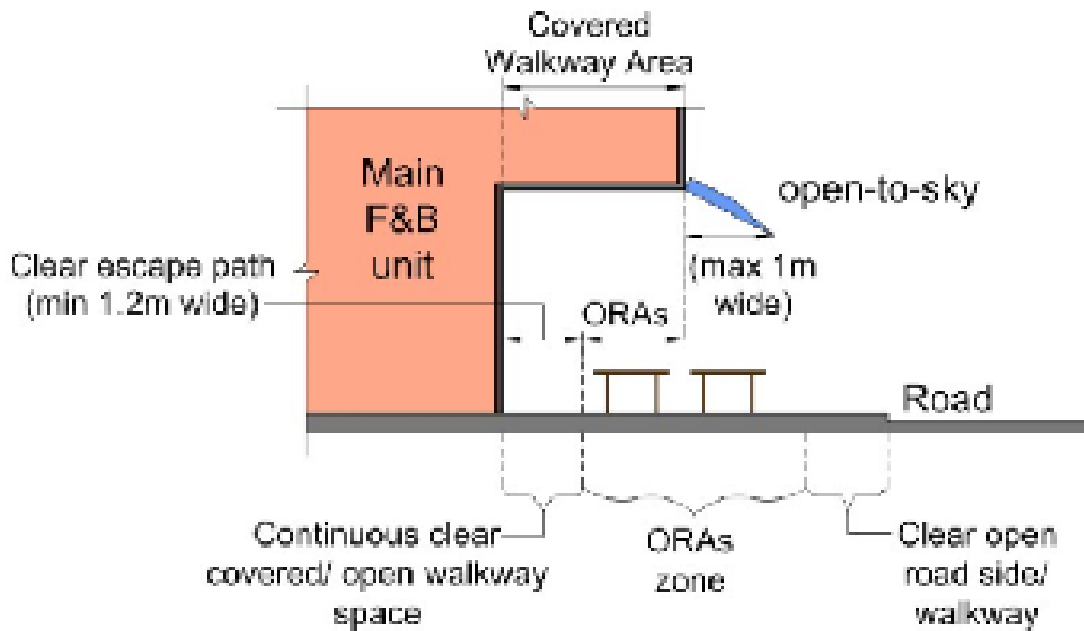

Cross sectional view

[Diagram 9.7.4b.\(4\)\(b\) : ORAs with canopy/awning projection not exceeding 1m](#)

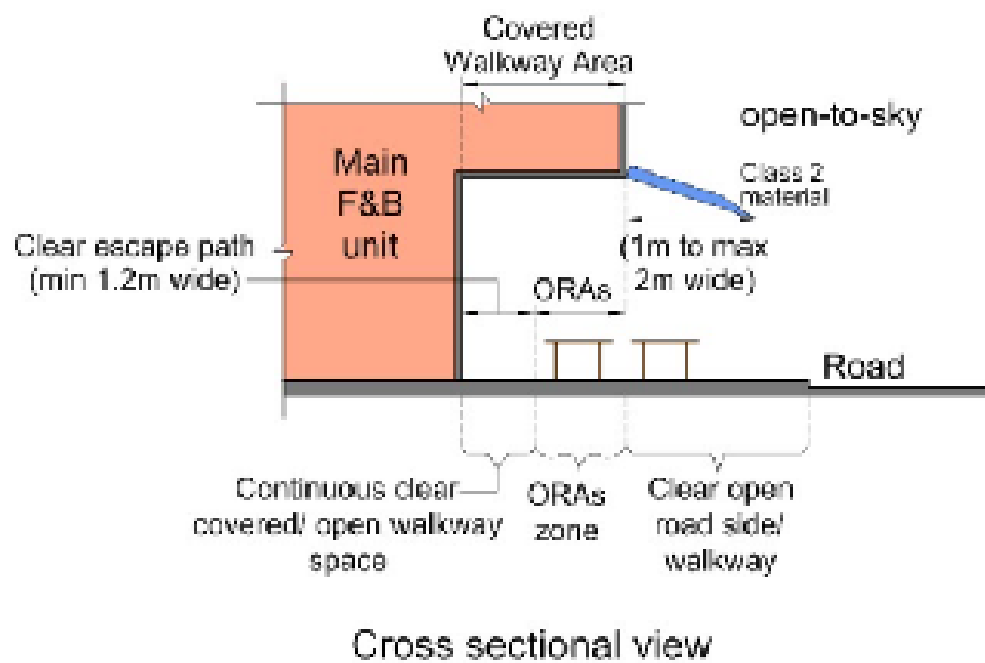
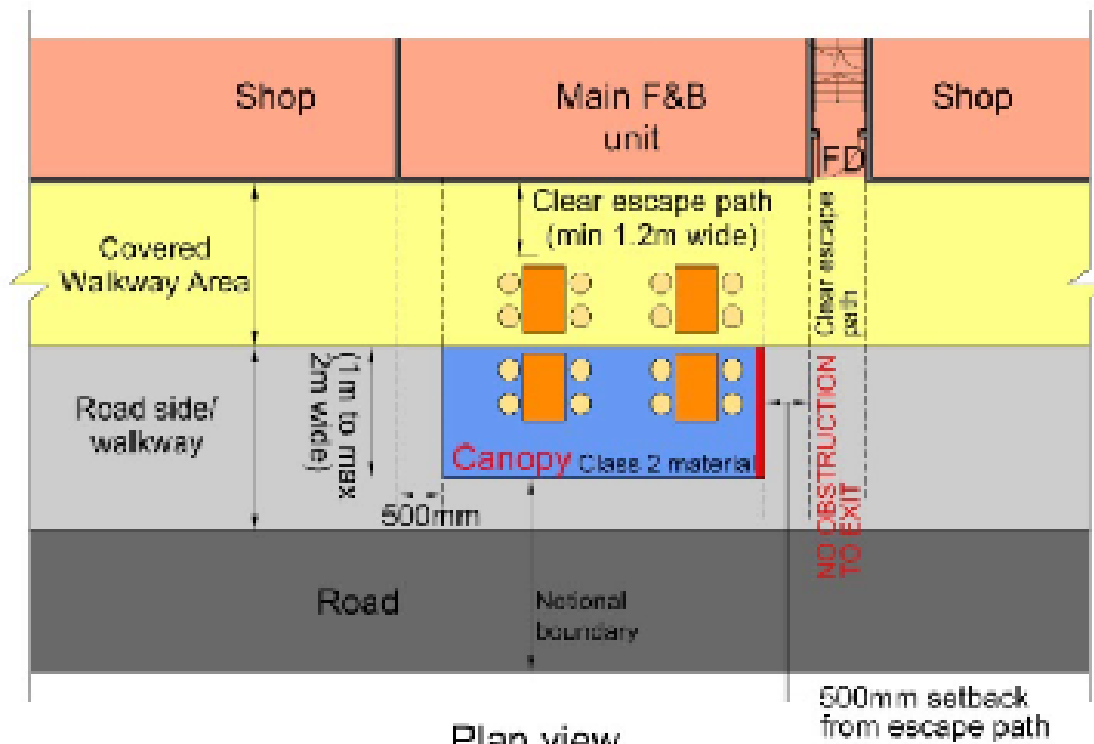

[Diagram 9.7.4b.\(4\)\(c\) - 1 : ORAs with canopy/awning projection greater than 1m but not exceeding 2m - \(without auto retraction\)](#)

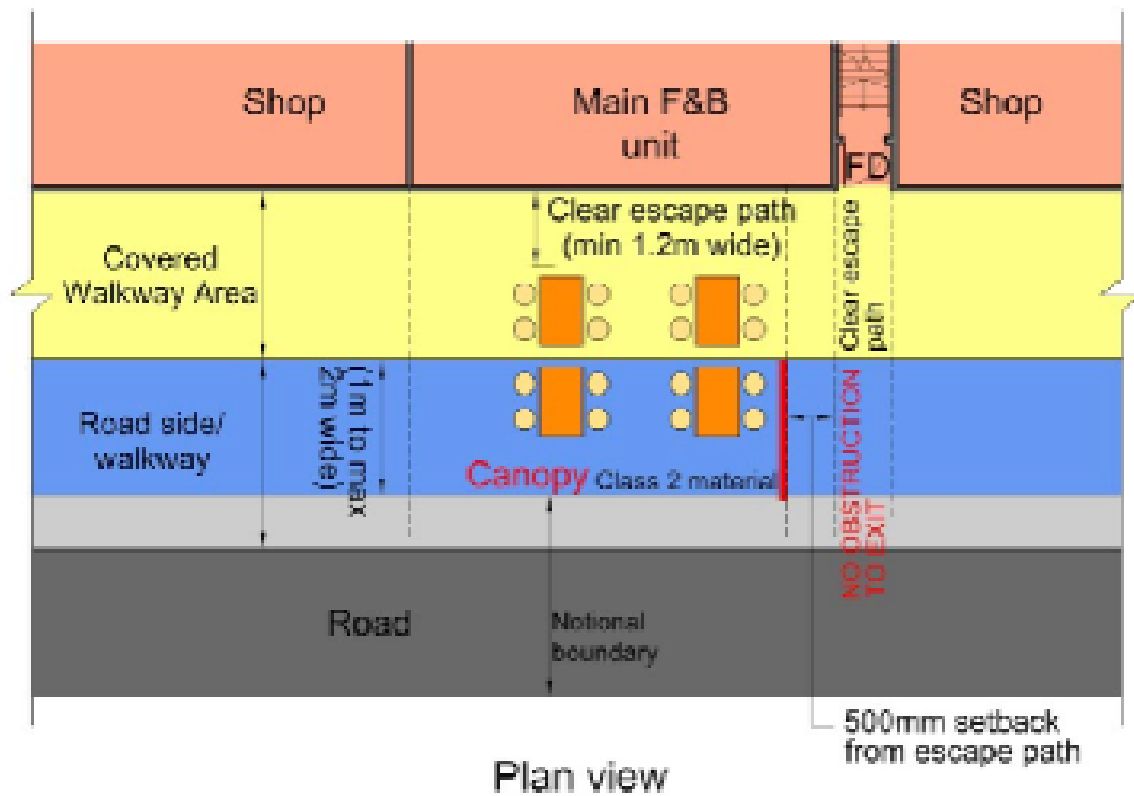

Plan view

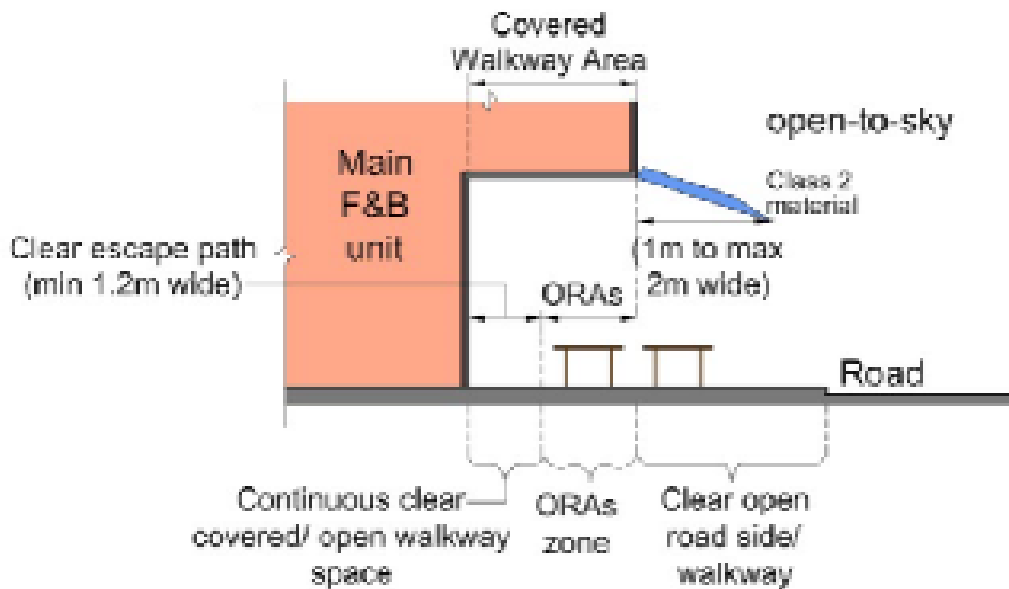

Cross sectional view

[Diagram 9.7.4b.\(4\)\(c\) - 2 : ORAs with canopy/awning projection greater than 1m but not exceeding 2m - \(with auto retraction\)](#)

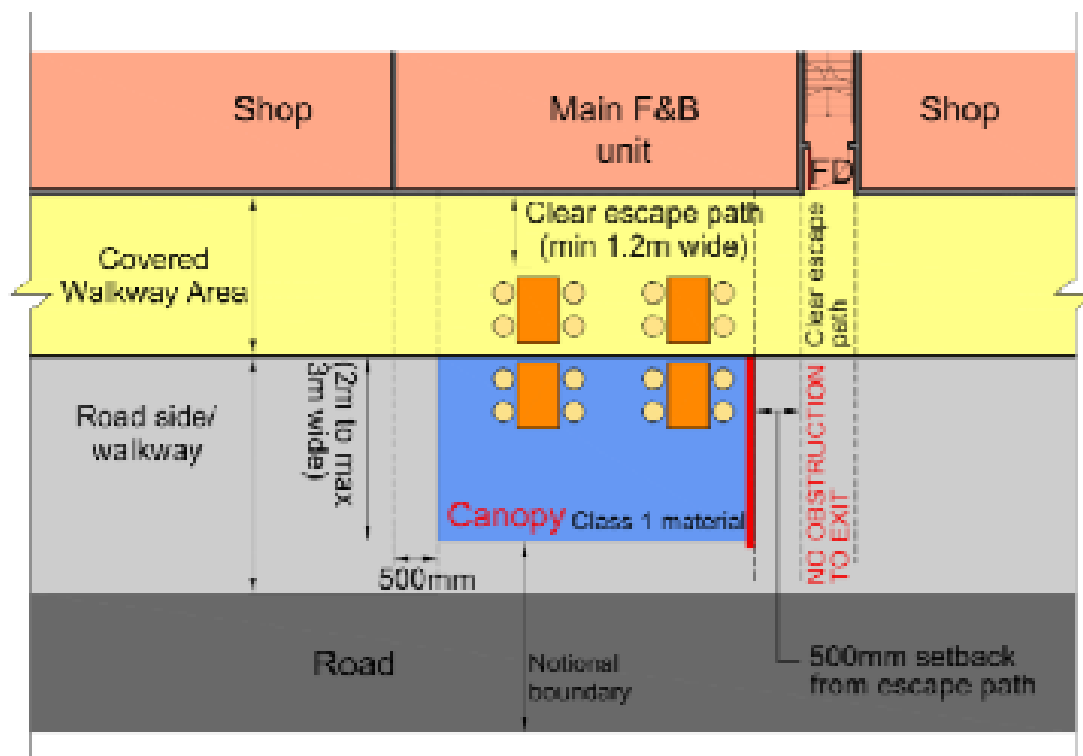

Plan view

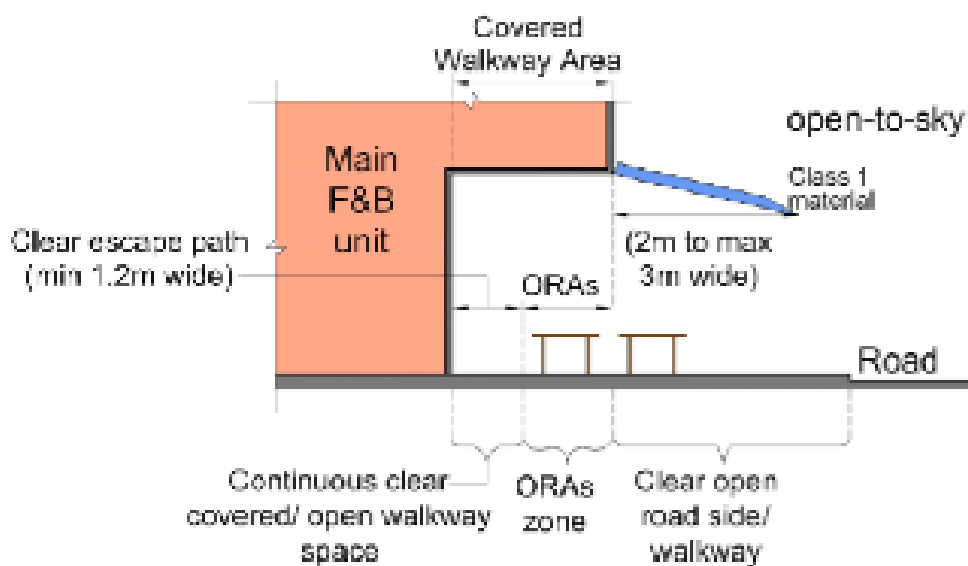

Cross sectional view

[Diagram 9.7.4b.\(4\)\(d\) : ORAs with canopy/awning projection greater than 2m but not exceeding 3m](#)

9.8 PURPOSE GROUP VIII OCCUPANCY

9.8.1 General

a. Means of escape

(1) **aboveground warehouse floors**

One exit staircase is permitted to serve an aboveground warehouse floor provided:

- (a) the habitable height of the floor shall not exceed 15m;
- (b) the floor shall not be located above 4th storey; and
- (c) the AFA of the floor shall not exceed 200m².

(2) **Mezzanine floors**

One open stair is allowed to serve a mezzanine floor(s) within an aboveground warehouse floor provided:

- (a) the aggregate AFA of the mezzanine floor(s) per warehouse unit shall not exceed 60m²;
- (b) the open stair shall have a width of at least 1m and be constructed of non-combustible materials;
- (c) the maximum travel distance measured from remote point on the mezzanine floor(s) to the exits shall comply with [Table 2.2A](#);
- (d) the elements of structure of the mezzanine floor(s) shall be of at least 1-hr fire resistance construction;
- (e) the habitable height of mezzanine floor shall not exceed 24m; and
- (f) mezzanine floor shall only be used for store and/or ancillary office.

b. Structural fire precautions

(1) **Vehicle parking area**

Fire compartmentation shall be provided between a vehicle parking area (PG VIII) and other areas, except for ancillary washrooms, the fire compartment walls and floors shall have at least 1-hr fire resistance rating.

Exceptions:

- (a) For a sprinkler-protected factory, compartmentation between the vehicle parking areas and the factory is not required, provided the vehicle parking area and adjacent driveway are provided with an engineered smoke control system.
- (b) For a sprinkler-protected warehouse, thermal insulation of the fire-rated shutters between the vehicle parking area and the

warehouse is not required, provided the vehicle parking/loading and unloading area and adjacent driveway are provided with an engineered smoke control system.

(2) Warehouse

Warehouse compartment size exceeding 700m² for above ground level and 100m² for below ground level are subject to full compliance of *Cl.9.8.3*.

9.8.2 Coldroom

Where coldrooms are provided in PG III, IV, V, VI, VII or VIII buildings, the following requirements shall be complied with:

a. Coldroom constructed of combustible insulation panels

(1) For non-sprinkler-protected buildings

Where the aggregate floor area of coldroom(s) exceeds 10m², a separate outer layer of non-combustible construction, including the door, having at least 1-hr fire resistance rating, shall be provided to compartmentalise the coldroom(s) from other areas. The maximum aggregate floor area of the coldroom(s) shall not exceed 100m² in each compartment.

(2) For sprinkler-protected buildings

Where the aggregate floor area of coldroom(s) exceeds 20m², a separate outer layer of non-combustible construction, including the door, having 1-hr fire resistance rating, shall be provided to compartmentalise the coldroom(s) from other areas/usages. The maximum aggregate floor area of the coldroom(s) shall not exceed 700m² in each compartment.

(3) Non-compartmentalised coldroom shall not be used for storage of highly flammable chemicals.

b. Coldroom constructed of fire-rated insulation panels

Where the coldroom panels are constructed of material having at least 1-hr fire resistance rating, the compartment sizes stipulated in *Cl.9.8.2a.(1)* and *(2)* above need not be complied with but are subject to a maximum of 2000m² (for non-sprinkler-protected buildings) or 4000m² (for sprinkler-protected buildings), or sizes stipulated under *Cl.9.8.4* for storage of chemical/HazMat materials, whichever is applicable and smaller.

c. Properties of coldroom panel

(1) All coldroom panels shall achieve at least Class B under EN 13501-1 or its equivalent, when tested as a composite panel with plastic or other types of core material.

(2) For a coldroom that consists of a processing/handling area, the toxicity emission and smoke density requirements shown in *Table 9.8.2c.(2)* for the insulation material shall be complied with.

TABLE 9.8.2c.(2) : TOXICITY EMISSION AND SMOKE DENSITY REQUIREMENTS		
Fire risk	Applicable fire test standards	Acceptance criteria
Toxicity emission	BS EN 45545-2; or	CIT < 0.75
	EN ISO 5659-2	
Smoke density	EN 13501-1; or	(a) Smoke classification to be of s1 rating (b) Flaming droplet classification to be d0 rating
	EN ISO 5659-2	VOF ₄ < 300 min

(3) For a standalone coldroom that does not have a processing/handling area, the above toxicity emission and smoke density requirements for the insulation material need not be complied with.

d. Coldroom panels supporting structures

All coldroom panels supporting structures shall have a fire resistance rating of at least 1 hour, unless it is located at an external space.

e. Activities involving open flame

Open-flame activities shall not be carried out in coldrooms. Where such activities are required due to the nature of the operation, the areas where open-flame activities are carried out shall be protected in accordance with *Cl.3.2.5f. (1)* and *(4)* and the coldroom insulation materials shall meet the toxicity emission and smoke density requirements stipulated under *Table 9.8.2c.(2)* above.

9.8.3 General warehouses

a. General

The scope of this section covers the fire safety requirements for general warehouses which include single-storey single-user warehouses, single-storey multi-user warehouses, underground warehouses, multi-storey warehouses with or without basements and warehouse within other non-industrial buildings.

b. Compartment

- (1) Departmental stores and supermarkets having displayed storage height more than 4m (with sprinkler protection) or 2.5m (without sprinkler protection) shall comply with the requirements as stipulated in this section.
- (2) The size of compartment shall not exceed the maximum allowable dimensions shown in the *Table 9.8A*, depending on the type of fire protection and location of the warehouse.
- (3) Compartmentation, in respect of size limitation, can be achieved by using fire-rated roller shutter. Localised smoke detector shall be installed to activate the roller shutter. The roller shutter shall also be linked to the building automatic fire alarm system which shall act as a backup for the

activation of the shutter.

Note: Such localised smoke detection system shall be provided with zone indication on the main fire alarm panel with buzzer sound, however its activation is not necessary to sound the general fire alarm.

- (4) Compartmentation between the warehouse and loading/unloading/staging area shall be provided (to comply with *Cl.9.8.3b.(3)*), except where:
- (a) the warehouse is a single-storey single-user or multi-storey single-user per storey type, with the loading/unloading area abutting an external space, or
 - (b) the roof over the loading/unloading (or staging) area abutting an external space is not more than 3m in depth.

Note: Down-stand fire wall of minimum depth 1m hanging from the ceiling shall be provided [except for *Cl.9.8.3b.(4)(b)*] between the loading/unloading area and the warehouse storage area.

- (5) The compartment size limit stipulated in *Table 9.8A* shall include the loading/unloading (or staging) area if it is not fire-compartmented from the warehouse area, unless:
- (a) the entire warehouse including, loading/unloading and driveway areas, is protected with sprinkler and smoke control systems; and
 - (b) the roof over the loading/unloading (or staging) area abutting an external space is not more than 3m in depth.

c. Sprinkler protection

- (1) Automatic sprinkler system shall be provided if the compartment size of the warehouse exceeds the maximum allowable size shown in the *Table 9.8A*.
- (2) Sprinkler coverage shall be extended to the areas shielded by access platforms in the high-rack storage warehouse. The supporting structures of the platforms shall have the same fire resistance rating as the element of structure of the warehouse.

d. Storage height control

- (1) Signage shall be provided on the walls of the warehouse (including the loading/unloading or staging area) to control the maximum allowable storage height and to maintain the minimum clearance below the sprinkler heads in accordance with SS CP 52.
- (2) A 50mm wide red line shall be drawn around the wall with signage indicated as “No Storage Above This Line”. This sign shall be provided at intervals not exceeding 15m.
- (3) The lettering of the sign shall be at least 100mm.

- (4) The storage height limitations shall be clearly indicated on building plans and on the walls of the warehouse at intervals not exceeding 15m.
- (5) Transient storage at loading/unloading (or staging) area shall comply with the [Table 9.8D](#) and [Table 9.8E](#) in terms of the storage height limit. For non-sprinkler-protected warehouse, the storage height shall be limited to 2.5m.

e. **Smoke control**

(1) **Provision**

The provision of smoke control shall be in accordance with [Table 9.8B](#), either in the form of smoke vent, smoke purging or engineered smoke control system depending on the fire compartment size and type of fire protection system.

(2) **Smoke vents**

Smoke vents (refer to [Table 9.8B](#)) shall comply with the requirements stipulated below:

- (a) They shall be of permanent open type and the effective opening shall be either comply with [Table 9.8B](#) or [Table 9.8C](#). Panels can be used as smoke vents provided they are designed to be activated automatically. The use of glass blocks as smoke vents are not permitted.
- (b) The minimum dimensions of vertical smoke vent shall be 400mm (length) x 600mm (height) and horizontal smoke vent (roof or ceiling) shall be 0.25m² in area.
- (c) No area in the warehouse shall be more than the stipulated distance (refer to either [Table 9.8B](#) or [Table 9.8C](#)) measured horizontally away from any vertical or horizontal smoke vent.
- (d) They shall be located at the highest unobstructed level along the perimeter walls of the warehouse.

(3) **Smoke purging system**

Replacement of smoke vents by smoke purging system is allowed provided that the warehouse is sprinkler-protected. The smoke purging system shall comply with [Cl.7.4.3](#).

(4) **Engineered smoke control**

Engineered smoke control systems shall comply with the requirements stipulated below:

- (a) They shall be provided if the floor area of the compartment is more than 5000m² or 2000m² for aboveground or underground warehouses respectively;
- (b) They shall be designed and installed in accordance with the

requirements stipulated in this Code or equivalent standards approved by the SCDF; and

- (c) The fire size determined shall be concurred by the SCDF before it is used for the design of the engineered smoke control system.

f. Fire extinguishers

- (1) Fire extinguishers shall be provided in accordance with SS CP 55.
- (2) Classification of storage hazards based on storage height shall follow Table 21(A) and Table 21(B) of SS CP 52 (refer to [Table 9.8D](#) and [Table 9.8E](#)) for the different categories of storage and overall stack heights. Ordinary hazard classification in SS CP 52 shall be taken as equivalent to medium hazard classification in SS CP 55.

9.8.4 Chemical/HazMat warehouses

a. Scope

- (1) Chemicals or hazardous materials (HazMat) have a wide range of properties and hazards, which shall be identified and understood in order to fulfil the requirements of safe warehousing. A complete understanding of the hazards requires an assessment of the container and packaging systems and storage arrangements. In addition, the requirements of general warehouse shall be complied with.
- (2) The fire safety requirement for laboratory storing and using chemicals/hazmat shall be in accordance with NFPA 45 [except for Maximum Allowable Quantity (MAQ) which shall be as stipulated in [Table 9.8K](#) and [Table 9.8L](#)].

b. Identification of hazardous materials (HazMat)

Substances listed as hazardous materials are classified as shown in [Table 9.8F](#).

c. Size limitation

- (1) For chemical/HazMat warehouses storing Class 3, 4 & 5 hazardous materials, the maximum floor area per compartment and type of fire protection system shall be as shown in [Table 9.8G](#).
- (2) Storage of compressed gases (Class 2), flammable liquid (Class 3), flammable solid (Class 4.2 & 4.3), oxidising agent (Class 5.1) and organic peroxide (Class 5.2) shall be located only at the ground floor with at least one external wall facing directly to an exterior open safe space unless otherwise stipulated.
- (3) Solid materials (Class 4.1) is allowed to be stored at aboveground floors of habitable height not more than 24m and the storage quantity shall be limited to 1200kg/m² of floor area.
- (4) Compressed gas cylinders (Class 2) are allowed to be stored at aboveground floors of habitable height not more than 24m provided that

a vehicular ramp (with turning facility) suitable for 30-tonne firefighting appliances is erected for direct access to the storage area.

- (5) For Class 2 HazMat, no stacking is allowed. The hazardous materials shall be laid directly on the floor.
- (6) Storage, use and handling of compressed gases (Class 2) shall be in compliance with NFPA 55 and it be allowed to be located at aboveground floor.
- (7) For sprinkler-protected warehouses, the storage height shall be limited to 18m for single- storey warehouse and 15m for warehouse that is located at 1st storey of a multiple-storey building. For non-sprinkler protected warehouse storing Class 3 HazMat, storage height shall be in compliance with NFPA 30 (basing on the flash points of the hazardous materials), subject to a maximum height of 3.6m.
- (8) Storage of oxidizers (Class 5.1, solid or liquid) shall be in compliance with NFPA 430 or AS 4326.
- (9) Storage of organic peroxide (Class 5.2) shall be in compliance with NFPA 432 or AS 2714.
- (10) No compartment in the chemical/hazmat warehouse shall comprise more than one storey.
- (11) Recommendations made within the individual Material Safety Data Sheet (MSDS) shall be complied with.
- (12) An approved layout plan (with the relevant TFP/FSC) with such hazmat warehouse/storage capacity highlighted shall be kept within the premises to facilitate the inspection and emergency operation procedures.

d. Provision of fire engine accessway

- (1) Fire engine accessway shall be provided for firefighting appliances. The minimum length of the accessway, based on the gross cubical extent of the entire warehouse space, shall be as shown in [*Table 9.8J*](#).
- (2) At least one external wall of the warehouse shall be directly fronting an empty space (such as turf area) of minimum width 2m. One of the access doors provided along this external wall shall be placed not more than 300m (for type K1) or 15m (for type K2) from the fire engine accessway/ fire engine access road for ease of firefighting.
- (3) For K3 and K4 compartments, at least one external wall shall be directly fronting an engine access road or access way. At least two exit access doors (minimum 15m apart) shall be provided along this external wall for ease of firefighting.
- (4) The loading and unloading (the area may be roofed over) shall be carried out directly from the exterior open space for type K2, K3 and K4 compartments.

- (5) For type K1 compartment, the distance from the external loading/unloading area (may be roofed over) to the access door of the compartment shall not be more than 10m for non-sprinkler-protected buildings and 15m for sprinkler-protected buildings. For Class 3 HazMat, the maximum volume of hazardous liquid shall be limited to 3000L or 5000L for non-sprinkler-protected and sprinkler-protected compartments respectively.
- (6) For storage of Class 4.1 HazMat aboveground level, fire engine accessway and the associated FAPs shall be provided for the full stretch of the external wall of the storage area.

e. Water supply for private hydrant

- (1) Water supply for hydrant system shall comply with the following requirements:
 - (a) hydrant fed by PUB mains is allowed for type K1 and K2 compartments. The water supply requirement shall comply with the [Cl.4.4.2a.](#)
 - (b) hydrant with dedicated pumping & storage facilities shall be provided for type K3 and K4 compartments. The water supply requirement shall comply with [Table 4.4A](#) of this Code with minimum running pressure of 3.5 bars (it shall be designed accordingly to individual emergency response plan and respective SOP).
- (2) The spillage control and retention basin for firefighting water for warehouse storage hazardous substances shall be in accordance with SS 532, NFPA 30 and requirements of authority having jurisdiction. Gate valve(s) shall be provided from the second containment (such as bund wall) at a safe location to allow the firefighters to operate during emergency and, the outlet shall be directly drained to a safe area or storm drain.

f. Mechanical ventilation systems

- (1) The ventilation systems for warehouse storing Class 3 HazMat shall comply with SS 532 and the smoke control system shall comply with the requirements for general warehouse.
- (2) The ventilation system for Class 2 shall comply with NFPA 55.
- (3) Mechanical ventilation system for removal of vapour shall be interlocked with the smoke control system to ensure that both systems will not be affecting one another.
- (4) The ventilation system shall be designed to provide air-movement across all portions of the room to prevent the accumulation of vapours. Short-circuiting of the mechanical ventilation system shall be avoided.
- (5) Fresh air inlets and exhaust outlets shall be properly located according to

the type of gases or vapours to be exhausted.

- (6) The air-conditioning system and MV system for the storage area of HazMat shall not be shared with other occupied areas.

g. Fire extinguisher

- (1) Fire extinguisher shall be provided complying with SS CP 55, SS 532 and other related standards. (Also, refer to the relevant MSDS and consult the manufacturer or supplier for the details.)
- (2) Additional mobile type 50kg ABC (foam or chemical powder) fire extinguishers having minimum 6m throw and discharge hose length of minimum 6m shall be provided to cover the loading and unloading area for K2, K3 and K4 compartment under hazard grade 2, 3 & 4. The access from any remote point of the loading/unloading area (including the parking lots area) to the 50kg fire extinguishers shall not be more than 15m.
- (3) For K1 compartment size, mobile type 50kg fire extinguisher shall only be required when the overall hazmat storage area is more than 100m².

h. Determination of exit requirement

- (1) The determination of travel distance in chemical/HazMat warehouse shall be in compliance with [Table 2.24](#) for high hazard occupancy, 10m/20m for non-sprinkler-protected building and 20m/35m for sprinkler-protected building.
- (2) All exit and access doors shall be provided with the proper hazard and warning sign on both sides of these doors.

i. Other fire safety requirements

The following standards and codes of practices (non-exhaustive) shall be complied with for the proposed chemical/HazMat warehouse:

- (1) SS CP 10, SS CP 52
- (2) SS 98, SS 254, SS 286, SS 532, SS 575, SS 578
- (3) AS 2714, AS 4326
- (4) NFPA 16, NFPA 45, NFPA 55, NFPA 400, NFPA 495
- (5) IEC 60079

9.8.5 Fully Automated Mechanised Car Parks (FAMCPs)

a. General

The provisions of this chapter of the Code shall serve to stipulate the fire safety requirements for the FAMCP. These requirements shall assist with plans submissions to the design, construction, protection, location and arrangement of the various fire safety provisions.

b. Parking height

The parking height refers to the height that shall be measured from the average level of the ground adjoining the outside of the external walls of the building to the highest or lowest car parking level. In situations where mixed usage involving above ground and underground car parking, the height shall be measured between the highest and lowest car parking levels.

c. Classification of FAMCP

The FAMCP shall be subdivided into three categories as follows:

- (1) Category 1a: Small aboveground having the following sizes:
 - (a) Maximum floor area: 200m² (Total area of car parking decks)
 - (b) Maximum cubical extent: 1400m³
 - (c) Maximum parking height: 10m
 - (d) Minimum side openings: At least one side of the FAMCP shall be fully open and facing the fire engine access road
- (2) Category 1b: Small above ground with deck sunken, having not more than 2 car parking level sunken below the ground level and having the following sizes:
 - (a) Maximum floor area: 200m² (Total area of car parking decks)
 - (b) Maximum cubical extent: 1400m³
 - (c) Maximum parking height: 14m (Subject to maximum parking height of 10m above ground level)
 - (d) Minimum side openings: At least one side of the FAMCP shall be fully open and facing the fire engine access road
- (3) Category 2: Any above ground that does not fall under Category 1.
- (4) Category 3: Any underground that does not fall under Category 1, including FAMCP that combines above ground (Category 2) and underground (Category 3) parking.

d. Fire safety requirements that are applicable to all three categories of FAMCP

The fire safety requirements that are applicable to all three categories of car parks are as follows:

- (1) areas within the car park building shall not be accessible to the public;
- (2) the car park building shall be classified as PG VIII (storage) as per [Table 1.4A](#);
- (3) means of escape shall be provided where there are areas that are accessible by the public and these shall be in accordance with the

requirements as for PG VIII buildings;

- (4) where a separation wall or floor is required, fire-rated floor of at least 2-hr fire resistance rating subject to compliance with the requirements of the elements of structure for PG VIII buildings shall be provided;
- (5) where an external wall is required in [Cl.3.5](#), fire-rated floor of at least 1-hr fire resistance rating subject to compliance with the requirements of the elements of structure for PG VIII buildings shall be provided;
- (6) for unprotected openings, [Table 2](#) of [Annex 3B](#) to [Cl 3.5](#) shall be complied with;
- (7) fire extinguishers having a minimum rating of 70B shall be provided at every entrance and exit of the car park;
- (8) hose reel coverage shall be provided for every entrance and exit of the car park;
- (9) where any such installation is required, its primary and secondary source of power supplies shall be in accordance with Chapter 5; and
- (10) fire engine access roads to be provided to gain access to the exit staircases.

e. **Category 1 fire safety requirements for small above ground fully automated mechanised car park (SA- FAMCP)**

- (1) The SA-FAMCP shall not exceed the following compartment limits as indicated in the table below:

TABLE 9.8.5e.(1) : COMPARTMENTATION OF SA-FAMCP		
Compartment	Maximum Floor Area	Maximum Cubical Extent
Compartment between average ground level and a height of 10m.	200m ² (Total area of car parking decks)	1400m ³

- (2) The SA-FAMCP shall be constructed of structural steel construction. Fire resistance to element shall be provided according to [Cl.3.3](#).
- (3) For SA-FAMCP having multi-car parking level, vertical fire separation between the upper and lower decks by using non-perforated and non-combustible materials (e.g. structural steel plate) shall be provided.
- (4) Fire engine access roads to be provided to gain access to the exit staircases.
- (5) Private fire hydrants if required shall be provided in accordance with [Cl.4.4](#).

- (6) At least one side of the FAMCP shall be fully open and facing the access road. The maximum distance measured from the opening(s) to the most remote part of the car parking deck shall not exceed 8m.

f. Category 2 fire safety requirements for above ground fully automated mechanised car park (A - FAMCP)

All A-FAMCP shall be subjected to the Fire Certificate scheme. The specific fire safety requirements for the A-FAMCP shall be as follows:

- (1) the A-FAMCP shall be constructed of structural steel construction. Fire resistance to element of structure shall be provided according to [Cl.3.3](#).
- (2) the vertical fire separation between the upper and lower decks by using non-perforated and non-combustible materials (structural steel plate) shall be provided.
- (3) firefighting provisions shall be provided as follows:
 - (a) all exit staircases shall conform to the requirements of [Cl.2.3.3](#);
 - (b) smoke-free approach as stated in [Cl.2.2.13](#) and Cl.2.2.14;
 - (c) fire doors of at least 1-hr fire resistance rating for the access of firefighters via the exit staircase into the car park. The fire door shall be of at least 850mm wide by 1000mm high with a visual glass panel. Wordings of “For smoke venting, do not enter” shall be posted on the external side of the door. The wordings shall be of at least 25mm in height.
 - (d) the numbers of exit staircases provided shall depend on the number of rising mains. Each rising main serving every car parking level shall provide the following coverage:
 - (i) an access platform of minimum width of 900mm shall be provided and shall be constructed with at least 1-hr fire resistance rating. Handrails shall be provided on both sides to prevent falls.
 - (ii) no part of any car parking deck shall exceed 28m.
 - (e) Breeching inlet serving rising main shall be located within 18m of the fire engine access road.
 - (f) Dry rising main shall be provided for height exceeding 10m and up to 60m. When the height exceeds 60m, wet rising main shall be provided. The breeching inlet shall be located at the foot of the riser stack. One standby fire hose shall be provided at the ground level of each staircase.
 - (g) Fire lift shall be provided for habitable height exceeding 24m.
 - (h) Where fire lift is required, a two-way voice communication system shall be provided between the Fire Command Centre and

the following areas:

- (i) every fire lift lobby, including 1st storey; and
- (ii) all firefighting-related mechanical equipment rooms inclusive of sprinkler pump room, wet riser pump room, etc..
- (i) FCC shall be provided in accordance with *Cl.8.2.4*.
- (j) Private fire hydrant where required shall be provided in accordance with *Cl.4.4*;
- (k) Fire engine access roads to be provided to gain access to exit staircases.
- (l) The A-FAMCP shall be protected by active firefighting systems such as sprinklers or clean agent fire extinguishing systems:
 - (i) Where sprinkler protection is installed, quick response sprinklers shall be provided. Each parking deck shall be protected by at least one sprinkler head.
 - (ii) Where clean agent fire extinguishing systems are installed, the amount of agent required to achieve the design concentration shall be based on total flooding method. Standby cylinders at 100% capacity shall be provided on site.
 - (iii) All doors, shutters, dampers, and/or openings shall be closed throughout the duration of gas deployment.
 - (iv) Bypass door shall be provided in the event where there are occupants inside A-FAMCP during gas deployment.
 - (v) Firefighters shall be able to activate the clean agent manually if the system was not activated during a fire.
- (m) Sump pit shall be provided to contain water discharge from sprinkler system. The capacity of the sump put shall be based on simultaneous operation of sprinklers for 4 car park decks for duration of 20 mins. Foam inlet in accordance to *Cl.6.2.7* shall be provided adjacent to the sump pit to address liquid fire (burning fuel on water).
- (n) For A-FAMCP protected by sprinkler systems, ventilation openings (with exhaust air outlet sited at high level and fresh air inlet sited at low level) of at least 2.5% of the largest floor area of any car parking level shall be provided. It shall be operated automatically by activation of sprinklers or heat detectors, if such openings are not naturally ventilated.
- (o) For A-FAMCP protected by clean agent systems, ventilation openings (with exhaust air outlet sited at high level and fresh air

inlet sited at low level) of at least 2.5% of the largest floor area of any car parking level shall be provided. It shall be operated manually by firefighters.

- (p) Addressable heat detectors shall be installed according to SS CP 10 and provided to every parking deck to assist firefighters in identifying the exact location of the car on fire. Each addressable heat detector shall be represented by its own LED indicator and shall be displayed at the sub-alarm panel according to their locations/levels. Sub-alarm panel shall be provided at the entrance on FAMCP.
- (q) Thermocouple reading for every parking level shall be provided as a means for firefighters to identify if the fire has been effectively extinguished. No point in the FAMCP shall exceed 10m from a thermocouple. A panel to display temperature readings shall be installed adjacent to sub-alarm panel.
- (r) The deck to deck height shall be at least 2.2m.
- (s) Self-Contained Breathing Apparatus (SCBA) shall be provided and maintained in a clearly marked cabinet for maintenance personnel. Maintenance personnel must be equipped with SCBA while working in A-FAMCP. Signage with words minimum 50mm shall be clearly visible and state: "Personnel must be equipped with SCBA during maintenance"
- (t) A-FAMCP shall be maintained and inspected yearly or at intervals specified by the individual system suppliers, whichever is shorter.

g. Category 3 fire safety requirements for underground fully automated mechanised car park (U – FAMCP)

All U-FAMCPs shall be subjected to the Fire Certificate scheme. The specific fire safety requirements for the U-FAMCP shall be as follows:

- (1) The compartmentation of the U-FAMCP shall not exceed the following sizes:

TABLE 9.8.5g.(1) : COMPARTMENTATION OF U-FAMCP		
Maximum Parking Depth	Maximum Floor Area	Cubical Extent
28m	2000m ² (Total area of car parking decks)	7000m ³

- (2) The U-FAMCP shall be constructed on structural steel construction. Fire resistance to element of structure shall be provided according to [Cl.3.3](#).
- (3) The vertical fire separation between the upper and lower decks by using non-perforated and non-combustible materials (structural steel

plate) shall be provided.

- (4) The U-FAMCP shall be provided with the following firefighting provisions:
- (a) all exit staircases shall conform to the requirements of *Cl.2.3.3*;
 - (b) smoke-free approach as stated in *Cl.2.2.13* and *Cl.2.2.14*;
 - (c) fire doors of at least 1-hr fire resistance rating for the access of firefighters via the staircase into the car park;
 - (d) the number of exit staircases provided shall depend on the number of rising mains. Each rising main serving every car parking level shall provide the following coverage:
 - (i) where internal access to every car parking deck is provided:
 - an access platform of minimum width of 900mm shall be provided and shall be constructed with at least 1-hr fire resistance rating with handrails provided on both sides; and
 - no part of any car parking deck shall exceed 28m.
 - (ii) where no internal access to every car parking deck is provided, the maximum distance measured from the staircase door to the most remote part of the car parking deck shall not exceed 8m.
 - (e) Breeching inlet serving rising main shall be located within a travel distance of 18m from the fire engine accessway/fire engine access road.
 - (f) Dry rising main shall be provided for height exceeding 10m and up to 60m. When the height exceeds 60m, wet rising main shall be provided. The breeching inlet shall be located at the foot of the riser stack. One standby fire hose shall be provided at the ground level of each exit staircase.
 - (g) Fire lift shall be provided for basement depth exceeding 9m.
 - (h) Where fire lift is required, a two-way emergency voice communication system shall be provided between the FCC and the following areas:
 - (i) every fire lift lobby, including first storey; and
 - (ii) all firefighting-related mechanical equipment rooms, inclusive of sprinkler pump room, wet riser pump room etc..
 - (i) FCC shall be provided in accordance with *Cl.8.2.4*.

- (j) Basement levels shall be provided with two-way emergency voice communication system in accordance with [Cl.8.2.2](#).
- (5) Private fire hydrant where required shall be provided in accordance with [Cl.4.4](#).
- (6) Fire engine access road to be provided to gain access to the exit staircases.
- (7) The U-FAMCP shall be protected by sprinklers or clean agent fire extinguishing systems.
 - (a) Where sprinkler protection is installed, it shall be in accordance with SS CP 52. Quick response sprinklers shall be provided. Each parking deck shall be protected by at least one sprinkler head.
 - (b) Where clean agent fire extinguishing systems are installed, they shall comply with NFPA 2001. The amount of agent required to achieve the design concentration shall be based on total flooding method.
 - (i) Standby cylinders at 100% capacity shall be provided on site;
 - (ii) All doors, shutters, dampers, and/or openings shall be closed throughout the duration of gas deployment;
 - (iii) Bypass door shall be provided in the event there are occupants inside U-FAMCP during gas deployment; and
 - (iv) Firefighters shall be able to activate the clean agent manually if the system was not activated during fire.
 - (c) Foam inlet in accordance to [Cl.6.2.7](#) shall be provided to address liquid fire (burning fuel on water).
- (8) Sump pit shall be provided to contain water discharge from the sprinkler system. The capacity of the sump pit shall be based on simultaneous operation of sprinklers for four car park decks. Foam inlet in accordance to [Cl.6.2.7](#) shall be provided adjacent to the sump pit to address liquid fire (burning fuel on water).
- (9) Smoke vents shall apply to basements not exceeding 1000m² in floor area and maximum 5m in depth measured from the ground level area to the lowest floor level.
 - (a) For U-FAMCP protected by sprinkler systems, ventilation openings (with exhaust air outlet sited at high level and fresh air inlet sited at low level) of at least 2.5% of the largest floor area of any car parking level shall be provided. It shall be operated automatically by activation of sprinklers or heat detectors, if such openings are not naturally ventilated.
 - (b) For U-FAMCP protected by clean agent fire extinguishing systems,

ventilation openings (with exhaust air outlet sited at high level and fresh air sited at low level) of at least 2.5% of the largest floor area of any parking level shall be provided. It shall be operated manually by firefighters. Smoke purging systems of 9 air changes per hour shall be provided if the basement exceeds 1000m² in floor area or 5m in depth measured from the ground level area to the lowest floor level.

- (c) For U-FAMCP protected by sprinkler systems, the smoke purging systems shall be operated automatically by activation of heat detectors.
 - (d) For U-FAMCP protected by clean agent fire extinguishing systems, smoke purging systems shall be operated manually by firefighters.
- (10) Detection systems shall be installed as follows:
- (a) Addressable heat detectors shall be installed according to SS CP 10 and provided to every parking deck to assist firefighters in identifying the exact location of the car on fire. Each addressable heat detector shall be represented by its own LED light indicator and shall be displayed at the sub-alarm panel in accordance to their locations/ levels. Sub-alarm panels shall be provided at the entrance of U-FAMCP.
 - (b) Thermocouple for every parking level shall be provided such that no point in the U-FAMCP shall exceed 10m from a thermocouple. A panel to display temperature readings shall be installed adjacent to the sub-alarm panel.
- (11) The deck-to-deck height shall be at least 2.2m.
- (12) Self-contained breathing apparatus (SCBA) shall be provided and maintained in a clearly marked cabinet for maintenance personnel. Maintenance personnel must be equipped with SCBA while working in U-FAMCP. Signage with words minimum 50mm shall be clearly visible and state: "Personnel must be equipped with SCBA during maintenance".
- (13) U-FAMCP shall be maintained and inspected yearly or at intervals specified by the individual system suppliers, whichever is shorter.

**TABLE 9.8A : COMPARTMENT SIZE & STORAGE HEIGHT FOR
GENERAL WAREHOUSE**

Location of Warehouse	Item	Sprinkler-protected	Non-sprinkler-protected	
		Storage Hazard	Storage Hazard	
		All	Normal	High
Single storey warehouse	Max. floor area per compartment	12000m ²	3000m ²	2000m ²
	Max. cubical extent per compartment	NC	12000m ²	7500m ²
	Max. storage height	18m	+ Ref Table 9.8D & E	12m
Warehouse located on 1 st storey of multi-storey warehouse	Max. floor area per compartment	12000m ²	3000m ²	2000m ²
	Max. cubical extent per compartment	NC	12000m ²	7500m ²
	Max. storage height	15m	+ Ref Table 9.8D & E	12m
Multi-storey warehouse with vehicular ramp (min. loading 30 tonnes with dry rising mains)	Max. floor area per compartment	9000m ²	3000m ²	2000m ²
	Max. cubical extent per compartment	NC	12000m ²	7500m ²
	Max. storage height	15m	+ Ref Table 9.8D & E	12m
Multi-storey warehouse without vehicular ramp	Max. floor area per compartment	6000m ²	3000m ²	2000m ²
	Max. cubical extent per compartment	NC	12000m ²	7500m ²
	Max. storage height	15m	+ Ref Table 9.8D & E	12m
Warehouse located in basement	Max. floor area per compartment	3000m ²	NP	NP
	Max. cubical extent per compartment	12000m ³	NP	NP
	Max. storage height	12m	NP	NP

Note :

NC = No Control

NP = Not Permit

* = Subject to full compliance of *Cl.3.2.7a.* and *Cl.1.4.67d.*

+ = Storage height not exceeding the limits for goods in the various categories suitable for ordinary hazard protection (you may also refer to Table 21(A) & 21(B) of SS CP 52).

TABLE 9.8B : SMOKE CONTROL REQUIREMENTS FOR GENERAL WAREHOUSE

Location of Warehouse	Compartment Size	Provision of Sprinkler System	Smoke Control Requirement
Aboveground level	$\leq 100\text{m}^2$	no	NR
	$\geq 100\text{m}^2$ and $\leq 400\text{m}^2$	no	^a Smoke vent (min % openings follow Table 2A)
	$\geq 400\text{m}^2$ to size limit of Table 1	no	^b Smoke vent (20% / 12m)
	$\leq 700\text{m}^2$	yes	NR
	$\geq 700\text{m}^2$ and $\leq 5000\text{m}^2$	yes	^c Smoke vent or ⁺ purging system
	$\geq 5000\text{m}^2$	yes	engineered smoke control system
Underground level (*Basement)	$\leq 2000\text{m}^2$	yes	^c Smoke vent or ⁺ purging system
	$\geq 2000\text{m}^2$	yes	engineered smoke control system

Note:

NR = Not Required

a = smoke vent openings base on the *Table 9.8C*;

b = smoke vent shall be at least 20% of the floor area it served and shall not be more than 12m measured horizontally away from any part of the warehouse;

c = smoke vent shall comply with *Cl.7.4.2* (adequately & evenly distributed along the perimeter of the fire compartment or basement);

+ = smoke purging system shall comply with *Cl.7.4.3* (adequately & evenly distributed within the fire compartment or basement);

* = smoke control system shall be provided for the entire basement except the protected exit shafts, lift shafts and M&E riser shafts.

TABLE 9.8C : SMOKE VENT REQUIREMENTS FOR NON-SPRINKLER-PROTECTED BUILDING

Minimum size of smoke vent opening (Percentage of floor area)	Horizontal distance from smoke vent*
	(m)
2.5%	12m
5.0%	15m
10.0%	18m
15.0%	21m
20.0%	24m

Note :

* = No area in the warehouse shall be more than the indicated distance measured horizontally from any vertical or horizontal smoke vent

**TABLE 9.8D : HIGH-PILED STORAGE RISK INVOLVING
FREE-STANDING STORAGE OR BLOCK STACKING**
[Extract from TABLE 21(A) of SS CP 52]

Category of storage	Overall stack height (m)	
	Non-encapsulated storage	Encapsulated storage
1	4.0	3.00
2	3.0	2.25
3	2.1	1.60
4	1.2	0.90

Note:

1. The term “store” or “storage” includes the warehousing or the temporary depositing of goods or materials while undergoing process.
2. To provide for any future requirements, the height of storage shall be taken as not less than 1m below any ceiling or roof.

**TABLE 9.8E : HIGH-PILED STORAGE RISK INVOLVING
POST OR BOX PALLETS OR PALLETISED RACK STORAGE**
[Extract from TABLE 21(B) of SS CP 52]

Category of storage	Overall stack height (m)	
	Non-encapsulated storage	Encapsulated storage
1	3.5	2.7
2	2.6	2.0
3	1.7	1.3
4	1.2	0.9

Note :

1. To provide for any future requirements, the height of storage shall be taken as not less than 1m below any ceiling or roof.
2. Good practice dictates that box or post pallet storage shall not exceed 2 rows wide in one direction.
3. Rack storage with aisles less than 1.2m in width is treated as multiple row racks.

TABLE 9.8F : IDENTIFICATION OF HAZARDOUS MATERIALS	
Class	Type of HazMat
1	Explosives (1.1 to 1.6)
2.1	Flammable gases
2.2	Non-flammable compressed gases
2.3	Poisonous gases
3	Flammable and combustible liquids
4.1	Flammable solids
4.2	Substances liable to spontaneous combustion
4.3	Substances which, dangerous when contact with water
5.1	Oxidizers
5.2	Organic peroxides
6.1	Poisonous substances
6.2	Infectious substances (etiologic agents)
7	Radioactive materials Category I
	Radioactive materials Category II
	Radioactive materials Category III
8	Corrosive materials
9	Miscellaneous hazardous materials (dangerous sub-substances)

TABLE 9.8G : SIZE LIMITATION

Hazard Grade#	Maximum Fire Compartment Size (m ²)			
	K1*	K2*	K3*	K4*
3 & 4	≤ 50m ²	≤ 200m ²	≤ 600m ²	≤ 900m ²
2	≤ 100m ²	≤ 400m ²	≤ 2400m ²	≤ 3600m ²
1	≤ 400m ²	≤ 2000m ²	**	**

Note :

- (1) The required fire protection system is only restricted to the chemical/HazMat warehouse fire compartment. However, automatic fire detectors (linked to approved alarm monitoring company) shall also be provided along the perimeter of the fire compartment wall if the building housing the HazMat warehouse is not protected with the automatic or the sprinkler system (it is only applicable where the warehouse is directly connected to other occupied area within the building through access opening);
- (2) The fire compartment wall shall be constructed with at least 2-hr fire resistance rating, regardless of the type of fire protection system. For Class 3 HazMat storage, it shall be masonry construction except the ceiling (all floor element above such HazMat storage shall be masonry construction with at least 2-hr fire resistance rating) can use fire-rated board but to comply fully with the M&E riser shaft requirements;
- (3) Different classes and incompatible HazMat shall be stored in separate fire compartment with at least 2-hr fire resistance rating;
- (4) No basement floor is allowed to store Hazardous materials;
- (5) The compartment size limit and type of fire protection system for Class 2 HazMat shall follow Hazard Grade 1 requirements;
- (6) Fire-rated roller shutter is not allowed for the purpose to limit the compartment size control; any fire-rated roller shutter at the access opening shall be activated by either local automatic smoke detection system or/and the general building automatic fire alarm system;

** = No specific limit but to comply with the fire safety requirements for general warehouse.

* = Refer to [Table 9.8H](#) for classification of fire protection system

= Refer to [Table 9.8I](#) for hazard grade classification

TABLE 9.8H : CLASSIFICATION OF FIRE PROTECTION SYSTEMS

CLASS	Fire Protection System	
	Type	Monitoring
K1	Manual fire alarm system	To be connected to an approved alarm monitoring company
K2	Automatic fire alarm system	To be connected to an approved alarm monitoring company
K3	Automatic fire sprinkler system	To be connected to an approved alarm monitoring company
K4	Automatic foam sprinkler system	To be connected to an approved alarm monitoring company

TABLE 9.8I : HAZARD GRADE CLASSIFICATION						
Hazard Classification		Hazard Grade				
		4	3	2	1	0
Liquids	Class 3	Category I & 2 Flash point < 23°C	Category 3 Flash point 23 - 60°C	Category 4 Flash point 60 - 150°C	Flash point > 150°C	Only burns with supporting fire
Solid Materials	Class 4	Ignites very easily and burns rapidly	Ignites and burns rapidly	Readily combustible	Moderately combustible	Combustible only with supporting fire
Oxidizing Agent	Class 5.1	Class 4 Vary strong oxidizing agent (may be classified under explosive substance)	Class 3 Strong oxidizing agent	Class 2 Weak oxidizing agent	-	-
Oxidizing Peroxide	Class 5.2	Class I	Class II	Class III	Class IV	Class V

TABLE 9.8J : PROVISION OF FIRE ENGINE ACCESSWAY		
Cubical Extent	Minimum Length of Fire Engine Accessway*	
	Non-sprinkler-protected	Sprinkler-protected
≤ 7100m ³	1/6 perimeter	1/6 perimeter
> 7100m ³ and ≤ 14200m ³	1/4 perimeter	
> 14200m ³ and ≤ 28400m ³	1/2 perimeter	1/4 perimeter
> 28400m ³ and ≤ 42400m ³	3/4 perimeter	1/2 perimeter
> 42400m ³ and ≤ 56800m ³	island site access	3/4 perimeter
> 56800m ³		island site access

Note :
* = Length of fire engine accessway shall be as shown or 15m, whichever is the greater.

**TABLE 9.8K : MAXIMUM ALLOWABLE QUANTITIES (MAQ)
IN LABORATORY FOR LIQUID**

Laboratory Unit	Max Quantity (excluding qty in cabinet)	Max Quantity (including qty in cabinet)	
	(litres per lab unit floor area)	(litres per lab unit floor area)	
Laboratory not within hospital or healthcare occupancy	1. liquids stored/used do not consist of category 1 or 2 flammable liquid	(a) 50 L or (b) 1.6 L/m ² and not more than: (1) 350 L for non-sprinkler-protected building, or (2) 500 L for sprinkler-protected building)	3.2 L/m ² and not more than: (1) 750 L for non-sprinkler-protected building, or (2) 1000 L for sprinkler-protected building)
	2. liquids stored/used consist of category 1 or 2 flammable liquid	(a) 20 L or (b) 0.8 L/m ² and not more than: (1) 250 L for non-sprinkler-protected building, or (2) 350 L for sprinkler-protected building)	1.6 L/m ² and not more than: (1) 500 L for non-sprinkler-protected building, or (2) 750 L for sprinkler-protected building)
Laboratory within hospital or healthcare occupancy	1. liquids stored/used do not consist of category 1 or 2 flammable liquid	(a) 10 L or (b) 0.4 L/m ² and not more than: (1) 150 L for non-sprinkler-protected building, or (2) 250 L for sprinkler-protected building)	0.8 L/m ² and not more than: (1) 250 L for non-sprinkler-protected building, or (2) 500 L for sprinkler-protected building)
	2. liquids stored/used consist of category 1 or 2 flammable liquid	(a) 5 L or (b) 0.4 L/m ² and not more than: (1) 150 L for non-sprinkler-protected building, or (2) 250 L for sprinkler-protected building)	0.8 L/m ² and not more than: (1) 250 L for non-sprinkler-protected building, or (2) 500 L for sprinkler-protected building)

Note :

- (1) Individual lab unit shall be a fire compartment;
- (2) Each safety cabinet is still restricted to max of 250 L (to comply with SS 532);
- (3) Laboratory operators are strongly advised and encouraged to minimise their amount of flammable liquids on benches by returning them to chemical store or safety cabinets (UL, FM or PLS listed product) when the liquids are not needed for the day. The quantity of these liquids placed on benches and fume cupboards shall not exceed 10% of the total allowable storage capacity within the lab unit. Liquids used for running and operating laboratory instruments or other works-in-progress which may require some quantities of solvents to operate are exempted from the 10% limit.

**TABLE 9.8L : MAXIMUM ALLOWABLE QUANTITIES (MAQ)
IN LABORATORY FOR GASES**

Item	Types of Gases	Maximum Quantity (litres per lab unit floor area protected by sprinkler system)
1	Flammable gasses	(a) 170 L or (b) 3.4 L/m ² per cluster
2	Oxidizing gasses	(a) 170 L or (b) 3.4 L/m ² per cluster
3	Liquefied flammable gases*	(a) 30 L or (b) 0.6 L/m ² per cluster
4	Toxic gasses	(a) 8 L or (b) 0.16 L/m ² per cluster

Note :

- (1) The capacity in litres (L) is referred to the internal volume (water capacity) of the gas cylinder;
- (2) Laboratory work area is not necessary be individual fire compartment but shall be housed within a lab unit;
- (3) For item 1 to 3, the MAQ shall be halved for those building which is not protected with sprinkler system;
- (4) Item 1 to 4 may be accommodated in a single cluster and be spaced at least 3m apart from each cluster (6m for building without sprinkler protection);
- (5) To comply with NFPA 45 for others requirements such as the ventilation (4 & 8 air changes), hazard identification and "No Smoking" signs etc.;
- (6) The provision of sprinkler system shall be designed under the Ordinary Hazard Group 3 Special (SS CP 52);
- (7) No combustible materials shall be placed within 3m buffer range of the gas cylinder;
- (8) No flammable or combustible liquid shall be placed within 6m buffer range of the gas cylinder;
- (9) For storage and handling of Class 2 HazMat in enclosed space (including the concealed space of raised floor and ceiling), metal pipe sleeve and gas leak detection system shall be provided to reduce the accumulation of gases and vapours that may cause danger to occupant, building and emergency response team. Oxygen-level monitoring system shall be provided to prevent the possibility of oxygen-deletion (asphyxiation) within the room;
- (10) The air-conditioning system and MV system for laboratory unit shall not be shared with other occupied areas.

* = For LPG cylinders, only 2 x 4.5kg cylinders are allowed for each lab unit.

9.9 OTHERS

9.9.1 Buildings designated for conservation and buildings built before 1969

a. General

Cl.9.9.1 can be applicable to buildings designated for conservation by the authority having jurisdiction or buildings with timber floors/staircases and built before 1969. Change of use of these buildings to public accommodation purpose is not permitted. Upgrading of fire safety works shall be applicable to the whole building; partial upgrading of building is not allowed.

b. Timber floor joists and boards without addition of new attic

(1) 2 and 3-storey shophouses

- (a) Timber floor boards shall be pressure-impregnated with flame retardant chemicals, in order to expose the timber floor joists and boards to retain the existing characteristics of the shophouse. For timber floor joints that fulfil the fire resistance rating requirements, they are not required to be pressure impregnated. Alternatively, timber floor boards shall be lined on the floor joists with non-combustible boards to achieve at least ½-hr fire resistance rating. For residential use, this condition does not apply. Existing timber floors can be retained provided there is no increase in floor areas or addition of a new attic. (See *Diagram 9.9.1b.(1)(a) - 1 & 2*)
- (b) Timber floor joists and boards at the soffit of the five-footway ceiling can be left exposed.

(2) 4-storey shophouses

- (a) Timber floor joists and boards shall be lined on the underside between the floor joists with non-combustible boards to achieve at least 1-hr fire resistance rating.
- (b) Timber floor joists and boards at the soffit of the five-footway ceiling can be left exposed.

c. Timber floor joists and boards with addition of new attic

(1) 2-storey shophouses

- (a) Timber floor boards lined on the underside between the floor joists with non-combustible boards to achieve at least ½-hr fire resistance rating. (See *Diagram 9.9.1c.(1)(a)*)
- (b) Timber floor joists and boards at the soffit of the five-footway ceiling can be left exposed.
- (c) The floor area of the attic shall not be lower than the highest point of the front façade window at the last storey, i.e. top of the window or fanlight.

- (d) The floor area of the attic shall not exceed 50% of the floor immediately below or 50m², whichever is less, per compartment.
- (e) An open connecting staircase to the attic can be considered, provided that the travel distance complies with C1.9.9.1g..

(2) 3 and 4-storey shophouses

- (a) Full protection shall be provided for floor joists and boards of all floors, i.e. timber floor boards shall be lined on the underside between the floor joists to achieve at least 1-hr fire resistance rating. (See *Diagram 9.9.1c.(2)(a)*)
- (b) Timber floor joists and boards at the soffit of the five-footway ceiling can be left exposed.
- (c) The floor level of the attic shall not be lower than the highest point of the front façade window at the last storey, i.e. top of the window or fanlight.
- (d) The attic floor shall be set-back at least 1.5m from the inner face of the front façade and rear walls to allow for visual connection to the storey below. (See *Diagram 9.9.1c.(2)(d)*)
- (e) The floor area of the attic shall not exceed 50% of the floor immediately below or 50m², whichever is less, per compartment.
- (f) An open connecting staircase to the attic is allowed provided that the travel distance complies with C1.9.9.1g.

d. Protection of exit staircases

(1) 2-storey shophouses

- (a) Timber staircases, which serve as a means of escape, shall be protected and comply with:
 - (i) Compartmentation requirements of at least 1-hr fire resistance rating; and
 - (ii) Pressure impregnation with flame retardant chemicals.
- (b) For residential shophouses, without addition of new attic and to be occupied by one family only, the timber staircase can be left exposed and need not be compartmentalised.
- (c) For non-residential shophouses, the timber staircase can be left exposed at the second storey level, provided all of the following are complied with:
 - (i) Travel distances on the second storey are complied with, i.e. the distance from the most remote point of the floor to the edge of the staircase landing is less than 13m or alternative escape staircase is available, e.g. rear escape staircase.

- (ii) The timber staircase is compartmentalised at the first storey by at least 1-hr fire-rated enclosures.
- (iii) There is no attic level in the second storey.

(2) 3-storey shophouses

- (a) Timber staircases, which serve as a means of escape, shall be protected and comply with:
 - (i) Compartmentation requirements of at least 1-hr fire resistance rating; and
 - (ii) Pressure impregnation with flame retardant chemicals.
- (b) For residential shophouses, without addition of new attic and to be occupied by one family only, the timber staircase can be left exposed and need not be compartmentalised.

(3) 4-storey shophouses

Timber staircases, which serve as a means of escape, shall be protected and comply with:

- (a) Compartmentation requirements of at least 1-hr fire resistance rating; and
- (b) Pressure impregnation with flame retardant chemicals.

e. Air well and covering over air well

(1) 2-storey shophouses

- (a) For air well that has the same usage for all floors, the following coverings shall be used:
 - (i) A fixed covering up to the level below the main roof eaves with approved materials such as non-drip acrylic, non-drip polycarbonate and glass, or
 - (ii) A fully openable covering (retractable or spring open type), by activation of smoke detectors and fire alarm system, up to the level below the roof eaves with approved materials such as non-drip acrylic, non-drip polycarbonate and glass.
- (b) For air well that has different usage for all floors, the following coverings shall be used:
 - (i) A fixed covering up to the 2nd storey floor level with approved materials such as non-drip acrylic, non-drip polycarbonate and glass, or
 - (ii) A fully openable covering (retractable or spring open type), by activation of smoke detectors and fire alarm system, up to the level below the roof eaves with approved materials such

as non-drip acrylic, non-drip polycarbonate and glass.

- (c) The air well shall not be enclosed.

(2) 3 and 4-storey shophouses

For air well that has the same usage for all floors, the following coverings shall be used:

- (a) A fixed opening up to the third storey level with approved materials such as non-drip acrylic, non-drip polycarbonate and glass, is allowed, or
- (b) A fully openable covering (retractable or spring open type), by activation of smoke detectors and fire alarm system, up to the level below the roof eaves with, such as non-drip acrylic, non-drip polycarbonate and glass.

f. Amalgamation of shophouse units

- (1) If the amalgamation of shophouses is more than two units, fire shutters or fire doors shall be provided to the openings at the separating wall between every two units of shophouses.
- (2) For amalgamation of shophouse units exceeding an AFA of 2000m², sprinkler system shall be provided for protection against rapid spread of fire due to higher fire load in a larger space.
- (3) Timber floor joints and boards shall be provided with full protection for all floors, i.e. covering the underside of the floor boards in between joists with non-combustible boards if the joist size is adequate.
- (4) Addition of attic floor shall not exceed 50m² per compartment.
- (5) If the units are to be used for public resort, such as restaurant, association, etc., there shall be a minimum of two protected exit staircases per floor.

g. Means of escape for all shophouses

- (1) If there is only one escape route, the maximum travel distance shall not exceed 13m for non-sprinkler-protected buildings. Residential shophouses not exceeding 3 storeys and occupied by one family only are not subject to this requirement.
- (2) Provision of at least ½-hr fire-rated door at the exit staircase discharge can be accepted in lieu of *Cl.2.3.3a.(3)*, which states that there shall be no unprotected openings of occupancy areas within 1.5m horizontally of the internal exit staircase ventilation/discharge point.

h. Alarm system for all shophouses

- (1) For shophouses not exceeding 3 storeys and/or amalgamation of not more than 2 shophouse units, manual alarm system is acceptable.
- (2) For shophouses exceeding 3 storeys or having an amalgamation of more

than 2 units, automatic alarm system shall be provided.

i. Covering of rear courtyard for all shophouses

- (1) If there is a protected exit staircase located at the rear courtyard, the entire space can be covered, up to the 2nd storey floor level, provided the exit staircase discharges to the back-lane.
- (2) If the exit staircase does not discharge directly to the back-lane but through the rear courtyard, that part of the rear courtyard forming the escape route from the staircase door to the back door shall be made a protected passageway.

j. Direction of door swing for all shophouses

- (1) Door swings at the first storey are allowed to swing into the units so as not to obstruct the walkways.
- (2) However, where the aggregate occupant load served by the exit staircase exceeds 50 persons, the door shall swing in the escape direction and shall be recessed.

k. Electrical/water/gas meters, telecoms trunking and hose reel pipes for all shophouses

- (1) For shophouses with a separate exit staircase enclosure at the front leading to the upper storeys, electrical and water meters and Telecoms trunking are allowed to be located within the exit staircase enclosure provided that they are boxed-up with non-combustible materials, e.g. non-combustible boards or metal casing.
- (2) All hose reel pipes are to be located within the shophouse and hose reels shall be located near exit doorways.

l. Retention of timber floor in main building to be conserved with new rear extension of reinforced concrete floors

- (1) Timber floors in the main building to be conserved with new extension of reinforced concrete floors are subject to the following requirements:
 - (a) The old and new blocks are to be treated as separate buildings;
 - (b) Independent escape staircases are to be provided in each of the old and new blocks and the regulation on maximum travel distance is to be complied with;
 - (c) A fire separation in the form of fire walls and fire doors is to be provided between the old and new blocks (see *Diagram 9.9.11.(1)(c)*);
 - (d) Air wells, if provided, shall have a minimum distance of 4m apart between window openings; and
 - (e) If integration is such that it is considered as a single block, the building (old and new) shall be constructed of reinforced concrete.

- (2) Existing timber flooring of PG I residential building under conservation need not comply with the above-mentioned requirements provided that the following conditions are met:
 - (a) the residential building shall not exceed 3 levels (attic and basement shall be considered as a level);
 - (b) there shall be no amalgamation of units; and
 - (c) other requirements stipulated in the conservation requirements, such as protection to the existing timber flooring, etc. shall be complied with.

9.9.2 Temporary buildings on construction sites

All temporary structures/buildings including site offices or housing quarters on construction sites shall comply with SS 547.

9.9.3 Buildings under construction

For buildings under construction, the following fire safety requirements shall be complied with.

a. Provision of dry & wet risers

- (1) All rising mains (dry & wet) shall be made operational for all storeys (except the uppermost 3 storeys) as soon as the uppermost completed storey reaches 24m.
- (2) Dry & wet rising mains shall be installed progressively as the building gains height, in order to provide firefighting capabilities during all stages of construction. All outlets, landing valves inlets, water tanks and pumps, where required shall be provided and made readily operational.

b. Provision of normal lift/ passenger hoist

A normal lift shall be provided for the purpose of firefighting. If this is not possible at the construction stage, a passenger hoist (usually installed on site) shall be made available.

c. Provision of electrical supply

A generator set shall be provided for firefighting if the permanent power supply is not available prior to the completion of the building.

d. Provision of fire engine accessway

- (1) Adequate fire engine accessway shall be provided where practicable.
- (2) Where there is no fire engine accessway provided at site, the quantity of portable fire extinguishers shall be doubled and installed at every floor.

e. Provision of adequate pressure and flow

- (1) Rising mains shall be hydraulically tested and a pressure-release valve

shall be installed at the highest point of the riser stack. For wet riser system, a break tank of 11.5m³ shall be installed to support firefighting for at least 5 mins. The break tank and fire pumps shall be installed before the building reaches 60m.

- (2) For the testing of flow rate for the wet riser system, the topmost landing valve shall be tested (under pump/gravity feed) with a flow rate of at least 27 L/s.

f. Inspection checklist

The inspection checklist attached as [Annex 9.9A](#) shall be used for checking fire safety provisions for buildings under construction.

9.9.4 Use of hoardings and safety nets for alteration and alteration work

a. General

The use of hoardings and safety nets in existing buildings undergoing addition and alteration works shall comply with the requirements stated herein.

b. Means of escape

(1) Hoarding erected within building

- (a) It shall be constructed of non-combustible material. A minimum of 1.2m wide corridor shall be provided leading to the exit(s). The hoardings shall not obstruct the escape path of occupants within the building.
- (b) Alternate means of escape shall be provided outside the hoarded area if the exit(s) is obstructed due to the erection of the hoarding.

(2) Hoardings erected at the external of building

- (a) It shall be constructed of non-combustible material and a minimum 1.2m wide foot path shall be maintained for pedestrians. The hoardings shall not obstruct the discharge route of occupants exiting at the 1st storey units and from the exit staircase(s).
- (b) It shall not obstruct smoke dispersal and means of escape of nearby buildings. Where the close proximity of the partitions may affect the smoke dispersion and escape of occupants from the nearby building, the partitions shall be located at least 1.2m away from the building.

(see [Diagram 9.9.4b.\(2\) - 1 to 4](#))

c. Fire protection and firefighting provisions

(1) Hoardings erected within building

- (a) For addition & alteration works involving sprinkler/automatic alarm system, the systems covering these areas not under addition & alteration works shall remain active. For areas not

involved in addition & alteration works but detector/sprinkler heads are being isolated due to same zone/control valve, the management shall arrange for additional surveillance checks so as to be alerted of fire at its incipient stage.

- (b) Whenever possible, new systems shall be installed first before deactivating the existing systems so as to minimise the duration of no sprinkler/automatic alarm protection to the areas affected by A&A works.
 - (c) The sprinkler/automatic alarm system shall resume its operation again immediately at the end of the day wherever feasible.
 - (d) Within the hoarded area(s), 50kg fire extinguisher(s) in trolley shall be provided near the hoarding exit access door. Each fire extinguisher shall not cover more than 20m.
 - (e) Fire extinguishers and hose reels outside the hoarded area(s) shall be made available.
- (2) Hoardings erected at the external of building shall not obstruct public/private hydrant and fire engine accessway/fire engine access road.

d. Fire safety requirements for safety nets

- (1) Safety nets shall not obstruct the ventilation opening to rooms/areas where smoke ventilation is required, such as exit staircase, fire lift lobby, smoke-stop lobby, flammable stores, kitchen with open-flame cooking, car parks, etc..
- (2) No hot work and activities which generate sparks such as welding, cutting and grinding shall be permitted within 3m from the safety net. If unavoidable, these works shall be isolated/shielded from the safety nets by a non-combustible shielding material.

9.9.5 Engineered timber building construction

a. General

The engineered timber product shall be listed in accordance with the requirements of the product listing scheme.

b. Building design

- (1) The habitable height of any healthcare occupancy in an engineered timber building shall not exceed 12m, including mezzanine levels.
- (2) A fire safety performance-based (PB) approach shall be adopted in the design of any engineered timber building where its habitable height exceeds 12m.
- (3) The engineered timber building shall be fully protected by an automatic sprinkler system.

Exception: An automatic sprinkler system can only be exempted under the following circumstances:

- (a) alternative fire protection measures (e.g. fully encapsulated timber elements) are provided to minimise fire damage to the timber structures, in lieu of the sprinkler system;
 - (b) the building does not exceed 12m in habitable height;
 - (c) the building is protected by an automatic fire alarm system compliant with SS CP 10; and
 - (d) the building does not contain any healthcare occupancy.
- (4) Where an automatic sprinkler system is required, the system shall be designed in accordance with SS CP 52. The automatic sprinkler system shall not be shared among different engineered timber buildings if the latter is under different occupier. If the external facade of the engineered timber building is unable to meet the stated performance in accordance with [Cl.3.5](#) for prevention of external fire spread, the external facade shall be required to be protected by a deluge system in accordance to SS CP 52, or any other suppression system that is shown to be effective in preventing vertical fire spread.
- (5) The use of engineered timber for elements of structure shall be permitted only for areas above the floor slab of the ground floor. The ground floor slab and basement floors below it shall not have elements of structure constructed using engineered timber.
- (6) Essential escape provisions such as staircase shafts and lift shafts of an engineered timber building shall be constructed of non-combustible materials which achieve the necessary fire resistance rating.

Exception: Engineered timber can only be used as elements of structure for essential escape provisions under the following circumstances:

- (a) the surfaces of engineered timber elements shall be protected by fire-rated board so that the composite element is able to achieve the necessary fire rating;
- (b) the building does not exceed 12m in habitable height; and
- (c) the building does not contain any healthcare occupancy.

This exception shall not apply to staircase shelters designed to comply with the Technical Requirements for Storey Shelters.

- (7) Essential facilities for fire safety and firefighting operations (such as FCC, fire pump rooms, generator rooms, and smoke-stop/fire lift lobbies) shall be separated from other areas of the engineered timber building project by non-combustible material or encapsulated engineered timber, either of which shall achieve the necessary fire resistance rating.

- (8) The use of flammable gas cylinders for cooking is not permitted in the engineered timber building premises if the engineered timber building has access to piped-gas supply for cooking.
- (9) Where the usage of the building potentially involves the use of flammable gas cylinders (either for cooking, storage, factory production, etc.) which may result in explosions, the use of engineered timber as elements of structure is not allowed unless the engineered timber building is designed to take into account the explosive actions based on EN 1991 or other relevant internationally recognised standards.
- (10) Residential engineered timber building projects shall fully comply with the Technical Requirements for Household Shelters and Technical Requirements for Storey Shelters.
- (11) The engineered timber building project shall comply with the design & fire test performance requirements stipulated in European (EN) standards which include BS EN 1995, BS EN 1363, BS EN 1365 & other internationally recognised standards deemed appropriate and necessary by the SCDF.

9.9.6 Use of flammable refrigerants

- a. For PG I and II buildings, the use of flammable refrigerants is not permitted in building air-conditioning systems, which require installation of piping into occupied areas. This includes including both single and multi-split systems,

Exception:

- (1) The use of R32 is permitted in split air-conditioning systems.
 - (2) The use of flammable refrigerants is permitted in refrigerators, and standalone wall-mounted air-conditioners, provided:
 - (a) the refrigerator or air-conditioner is regulated by the authority having jurisdiction;
 - (b) the refrigerator or air-conditioner is meant solely for domestic use;
 - (c) the amount of flammable refrigerant has a charge weight cap of at most 150g; and
 - (d) the refrigerant is hermetically sealed within the refrigerator.
- b. For PG III to VIII buildings, the use of flammable refrigerants is not permitted in refrigeration systems, e.g. coldrooms, chiller rooms and food storage factories, which are meant for commercial purposes.

Exception:

The use of flammable refrigerants is permitted in standalone commercial refrigeration systems provided *Cl.9.9.6a.(2)(c)* and *Cl.9.9.6a.(2)(d)* are complied with.

- c. For industrial process refrigeration systems, flammable refrigerants are not permitted unless:
- (1) there are no alternatives which can achieve the necessary specific performance required for the industrial process; and
 - (2) workplace safety requirements of the authority having jurisdiction are complied with.

9.9.7 Mega underground developments

a. General

This section provides the broad fire safety requirements for mega underground developments. It is applicable to mega underground developments regardless of size and number of occupants. Mega underground development refers to underground levels with lifts and/or horizontal access as the primary means of egress. There is no habitable space immediately above the cavern units, which are enclosed chambers within the fire-compartmented underground developments.

b. Means of escape

- (1) Each underground development shall be provided with at least two exit shafts.
- (2) At least two exit staircases (at least 1.5m in width but not exceeding 2m) located at the exit shafts shall be provided for the underground development. The width of exit staircases shall be determined by the occupant load and uses of the cavern. The minimum width requirement is not applicable to exit staircases serving the cavern units. Such exit staircases shall comply with the requirements stipulated in [Cl.2.3.3](#). Exit staircases are not the primary means of escape.
- (3) Fire lift lobby shall be provided at each exit shaft.
- (4) All cavern units shall be provided with at least two-way escape regardless of whether one-way travel distance can be complied with. One-way travel distance shall not exceed 20m and two-way travel distance shall not exceed 50m.
- (5) The travel distance refers to the distance required to be traversed from the most remote point in the cavern to the edge of a fire door opening directly into the protected corridor.
- (6) Protected corridors (enclosed by fire-rated wall/floor) shall be provided for all cavern units at every storey. The corridor shall have direct access to the protected shaft.
- (7) Protected corridors shall be sectorised by fire doors. Each sector shall not consist of more than four cavern units or more than 60m (measure along the corridor). Only those doors in the sectors affected by fire need to be

closed during activation of alarm.

c. Structural fire precautions

- (1) Fire compartmentation shall be provided for each cavern unit. Each compartment shall not exceed 4000m² and 15000m³.
- (2) Different tenancy units shall be compartmented.
- (3) The element of structure/compartment of each cavern unit shall have fire resistance rating of at least 4 hours.
- (4) Walls, ceilings, roof covering and finishes containing plastic material shall comply with the requirements stipulated in *Cl.3.15.19*.
- (5) Internal non-load bearing walls and ceilings shall be constructed of non-combustible material.
- (6) The surface of a wall or ceiling along protected corridor shall have a surface spread of flame of Class 0 rating.
- (7) The exit staircases shall be constructed of masonry. However, if drywall construction is used it shall comply with *Cl.3.8.7b*.

d. Vehicular access

- (1) Fire engine access road having minimum 4m width and overhead clearance of at least 4.5m for access by pump appliance shall be provided for firefighters to conduct firefighting and rescue operations.
- (2) Provision to alternative means of vehicle access into the underground development shall be considered.
- (3) The fire engine access road shall be protected from fire and smoke, and shall lead directly to the ground level.
- (4) Clear smoke height shall be maintained along the access road. Pushing the smoke out directly through the tunnel is not allowed.
- (5) Private hydrants shall be provided along the fire engine access road such that every part of the fire engine access road shall be within an unobstructed distance of 50m from the nearest hydrant.

e. Firefighting provisions

A room shall be provided to house the firefighting and rescue equipment. The requirements for storage area are as follows:

- (1) two storage areas per storey, with one near each of the exit shafts;
- (2) room size shall comply with the dimensions 2m in width, 2m in length and 2.1m in height; and
- (3) provision of four 64mm-diameter hoses, four 38mm-diameter hoses, one dividing breeching, two 38mm-diameter nozzles and two complete sets

of breathing apparatus.

- (4) buggies shall be provided at each level to facilitate firefighting and rescue operations. The requirements for buggies are as follow:
 - (a) 2 buggies per level. Each near the room storing firefighting equipment;
 - (b) 4 seaters;
 - (c) able to mount 1 stretcher;
 - (d) electrically-operated;
 - (e) the size of the buggies shall be of approved type by the SCDF; and
 - (f) the buggies can be used by in-house fire and security personnel provided the buggies are driven back to the holding area during emergency.

f. Firefighting system, detection and alarm

- (1) The underground development shall be protected with an automatic sprinkler system.
- (2) Wet risers shall be provided such that every part of the underground development is not more than 38m from the nearest wet riser landing valve. The wet riser pipes are allowed to run horizontally but the landing valves shall be located within the protected corridor.
- (3) Breaching inlet shall be installed at one of the vertical access shafts at ground level. It shall be located near the FCC.
- (4) At least two fire lifts shall be provided for each exit shaft. The fire lift shall have access to every habitable floor and shall be adjacent and accessible to an exit staircase and be approached by a firefighting lobby at each storey. The fire lifts shall home to the ground level (i.e. top of shaft) during activation of alarm and power failure.
- (5) All passenger lifts shall be double up as evacuation lift and shall be located within the fire lift lobby. They need not be fire lifts but shall be installed with evacuation switch, connecting to the emergency backup supply, and shall home to ground level in an emergency. The use of these lifts for emergency evacuation shall be supervised by the emergency responders.
- (6) The fire lift car shall have a clear area/space of not less than 2m (depth) x 1.5m (width).
- (7) Water mist system can be permitted as substitute of automatic sprinklers provided that the requirements are in accordance with [Cl.6.4.6](#).
- (8) FCC shall be located at ground level. It shall be located beside one of the protected shafts.

g. Effective communication systems and holding area

- (1) Effective communication system shall be provided for the SCDF at the underground developments to conduct firefighting and rescue operations.
- (2) One-way emergency voice communication system such as emergency wireless broadcast system shall be provided for the underground developments. Two-way emergency voice communications system shall be provided between FCC and the essential areas stipulated in [Cl.8.2.2](#).
- (3) A holding area shall be provided for the underground development. The size of the holding area shall take into considerations the total occupant load within that floor and shall be calculated based on 0.3m²/person.
- (4) The holding area shall be provided with engineered smoke control system and shall have direct connection to the fire lift lobby.

h. Mechanical ventilation and smoke control system

- (1) Engineered smoke control system shall be provided for the underground development and fire engine access road.
- (2) Exit staircases, smoke-stop lobbies and fire lift lobbies shall be pressurised.
- (3) The air-handling system for the affected smoke zone and the adjacent zones shall be shut down to avoid re-circulating through the system.

i. Restriction of hazardous materials

- (1) Hazardous, flammable and combustible materials shall be prohibited or controlled strictly if they have to be used within the facilities.
- (2) If small quantities are needed, special approval has to be obtained from the SCDF.

j. Provision for emergency directional signage/generator

- (1) Photoluminescent marking/tape to guide occupants along evacuation routes to appropriate exits shall be provided:
 - (a) along internal walls and/or floors of the exit staircase and protected lobby;
 - (b) at the exit staircase door; and
 - (c) in designated corridor with exit directional sign.
- (2) The duration of operation for standby generator shall be in accordance with the requirements stipulated in SS 535.
- (3) Lifts at the cavern units shall be connected to the standby generator.

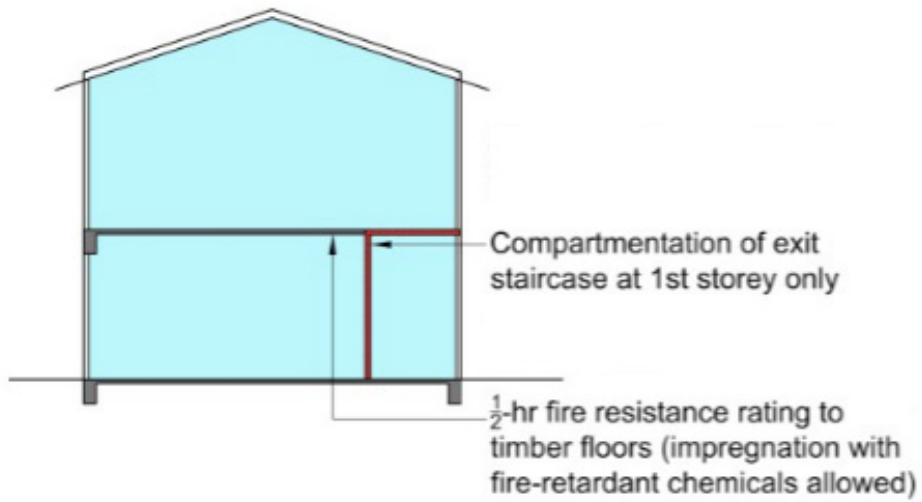

[Diagram 9.9.1b.\(1\)\(a\) - 1 : Retaining exiting 2-storey shophouse](#)

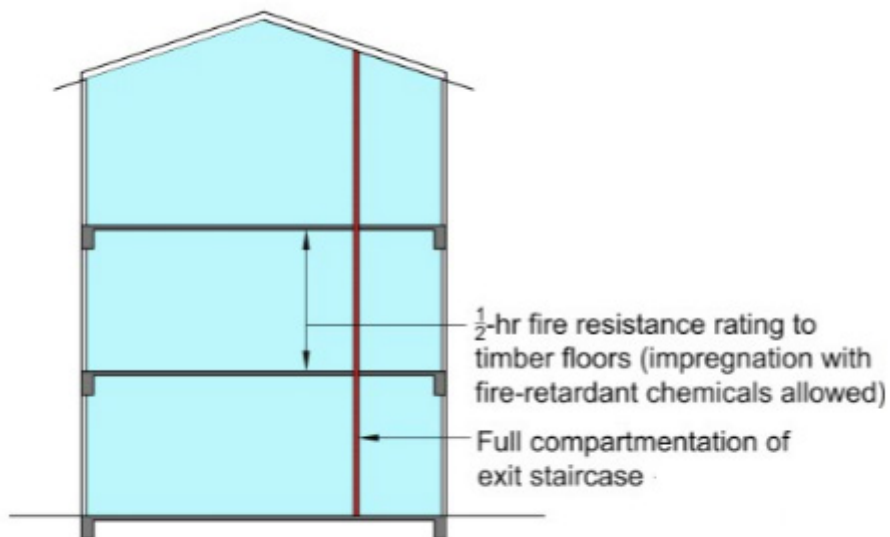

[Diagram 9.9.1b.\(1\)\(a\) - 2 : Retaining exiting 3-storey shophouse](#)

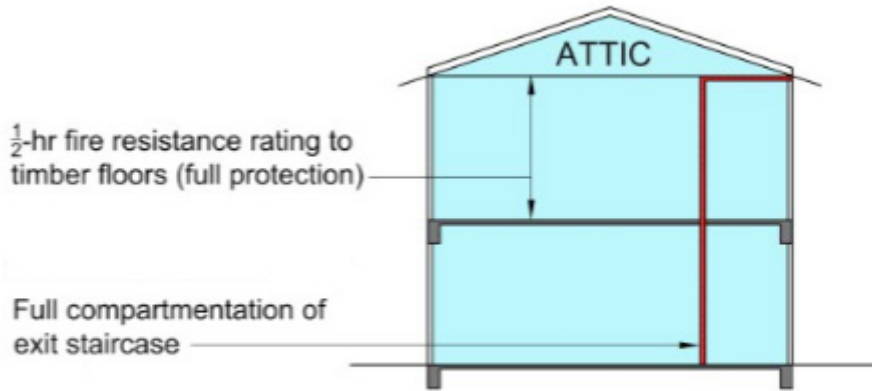

[Diagram 9.9.1c.\(1\)\(a\) : Adding new attic to exiting 2-storey shophouse](#)

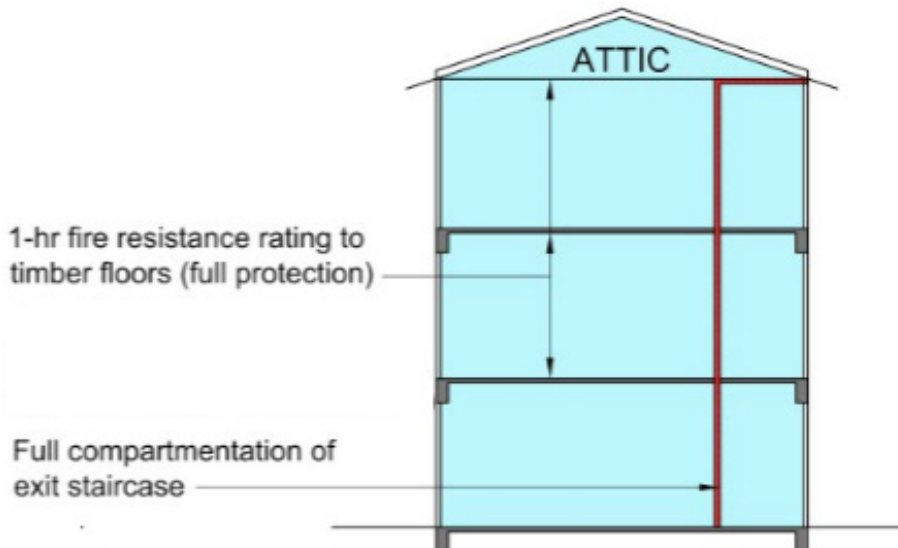

[Diagram 9.9.1c.\(2\)\(a\) : Adding new attic to exiting 3-storey shophouse](#)

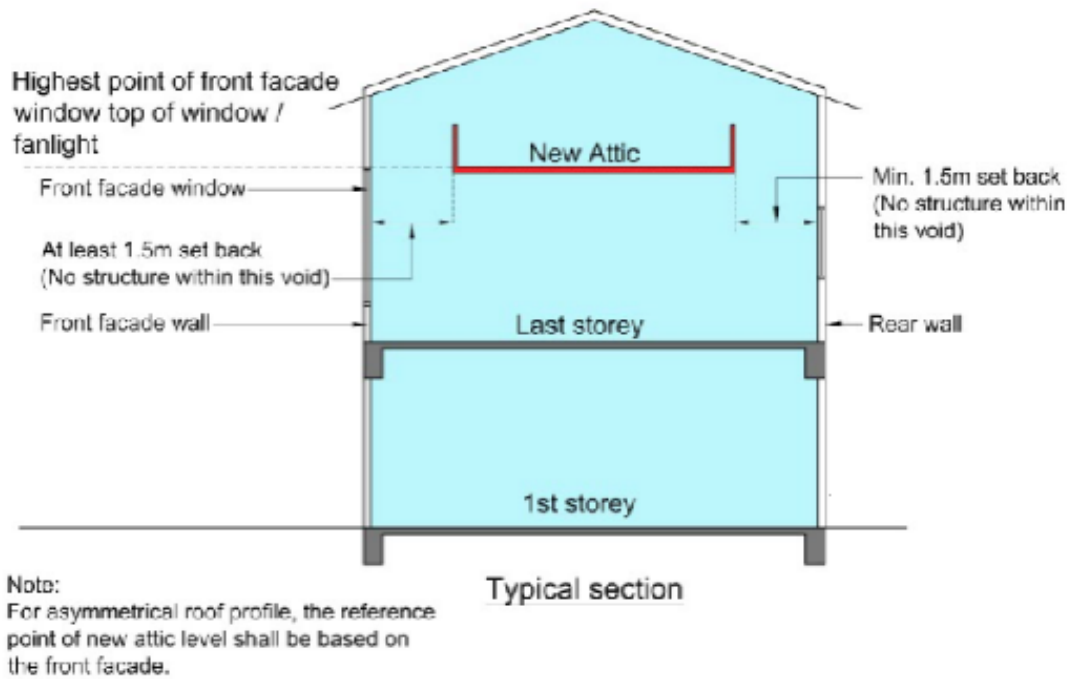

[Diagram 9.9.1c.\(2\)\(d\) : Visual connection between the attic and the floor below](#)

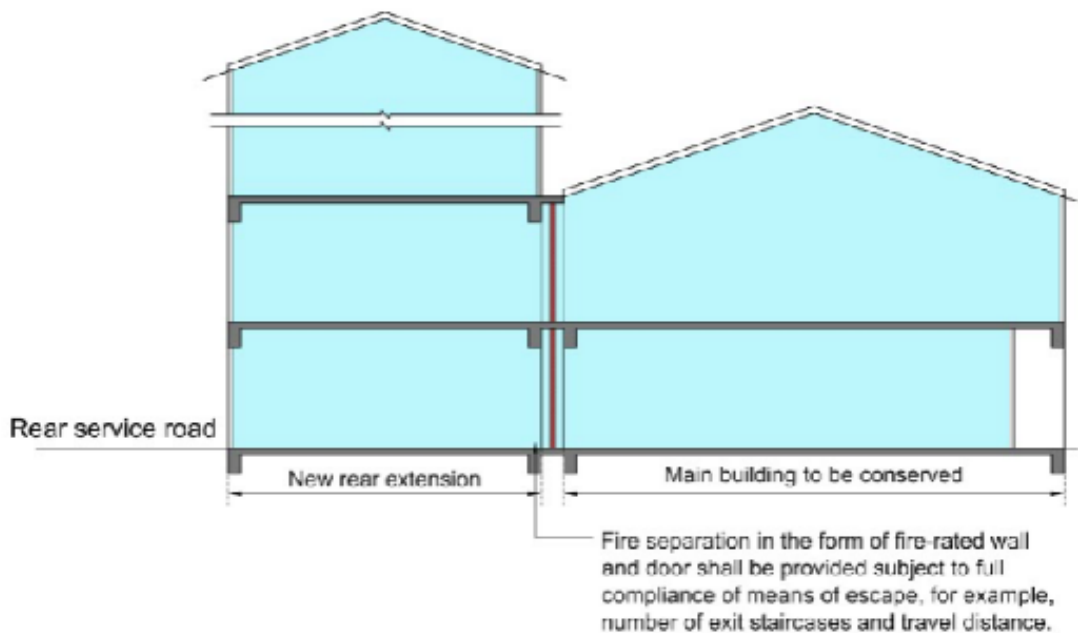

[Diagram 9.9.1l.\(1\)\(c\) : Fire separation between the old and new blocks](#)



[Diagram 9.9.4b.\(2\) - 1 : Hoarding obstructing means of escape](#)



[Diagram 9.9.4b.\(2\) - 2 : Hoarding obstructing means of escape](#)



[Diagram 9.9.4b.\(2\) - 3 : Hoarding obstructing openings for smoke dispersal](#)



[Diagram 9.9.4b.\(2\) - 4 : Hoarding obstructing openings for smoke dispersal](#)

**ANNEX 9.9A : INSPECTION CHECKLIST FOR
BUILDING UNDER CONSTRUCTION**

S/No	Description	In Order		If no, remedy action/comments
		Yes	No	
PART A : PROVISION OF FIREFIGHTING SYSTEMS				
Rising Mains				
1	Dry rising mains shall be installed progressively during the course of construction as per approved plan and made operational for all storeys except the uppermost 3 storeys, for building exceeding 8 storeys or habitable height of 24m.			
2	Wet rising mains shall be installed progressively during the course of construction as per approved plan and made operational for all storeys except the uppermost 3 storeys, for building exceeding 18 storeys or habitable height of 60m. The following shall be provided: (a) break tank with minimum water capacity of 11.5m ³ ; and (b) fire pumps which are operational and supplied with emergency power supply.			
3	Provision of breeching inlets (2-way/4-way)* provided as per approved plan. The following shall be complied with: (a) breeching inlets made operational and housed in protective enclosure; and (b) labelled and numbered accordingly.			
4	Riser stacks are labelled and numbered and: (a) earthing is provided; and (b) air relief valve is provided.			
5	Landing valves provided with blank caps and are strapped and padlocked in closed position.			
Lift				
6	Lift/passenger hoist ready for firefighters' use shall be provided for building exceeding 8 storeys or habitable height of 24m.			
Generator				
7	Generator set or adequate PUB power supply shall be provided for emergency lighting and firefighting purpose.			

ANNEX 9.9A

Fire Engine Accessway				
8	Provision of adequate fire engine accessway (where practicable) for firefighting purpose.			
Fire Extinguisher				
9	At least one fire extinguisher of 13A rating shall be provided for every 500m ² or less on each floor. Where provision of fire engine accessway is not practicable, the quantity of fire extinguishers shall be doubled on each floor.			
PART B : TESTING OF RISING MAINS				
Breeching Inlet				
1	Inlet housed in protective enclosure			
2	Rigidly support			
3	Labelled " dry/wet riser inlet " and numbered accordingly			
4	Clear of obstruction			
Riser				
5	Air relief valve provided			
6	Labelled & numbered accordingly			
7	Earthing provided			
Landing Valve				
8	Blank cap provided			
9	Strapped and padlock in closed position			
10	Clear of obstruction			
Pressure/Flow				
11	Rising mains piping Hydrostatically tested at 1380 kPa (13.8 bar) or 1.5 times the design pressure, whichever is greater, for 2 hours.			
12	Wet rising mains (a) Flow rate at the topmost fully-opened landing valve (under pump/gravity feed) is at least 27 L/s.			
	(b) Running pressure is between 2 bars and 5.5 bars at the landing valve.			

*Delete as appropriate

Date inspected: _____ by _____ Signature _____

The background of the entire page is a detailed architectural floor plan, rendered in a light, faded grey color. It shows various rooms, corridors, and structural elements of a building, providing a technical and professional context for the chapter title.

CHAPTER

10

**REQUIREMENTS FOR
SPECIAL INSTALLATIONS**

CHAPTER 10

REQUIREMENTS FOR SPECIAL INSTALLATIONS

10.1 LIQUEFIED PETROLEUM GAS (LPG) CYLINDER INSTALLATION

10.1.1 General

- a. The section stipulates the fire safety requirements for the commercial, industrial and residential premises with eating outlets, eating places, canteens, restaurants and other eateries which use LPG for cooking purposes. It is also intended for industrial applications involving hot works.
- b. All LPG cylinder installations shall be located outdoors and on the ground levels for all commercial and industrial buildings. Locating LPG cylinders indoor is normally not permitted, unless otherwise approved by the SCDF under special circumstances (see [Annex 10.1B](#)).
- c. A maximum of 30kg (2 x 15kg cylinders) is permitted to be installed or stored within private dwelling unit for domestic use.
- d. NFPA 54 and NFPA 58 shall be referred to for requirements not effected or covered under this chapter.
- e. LPG plans shall include the following items:
 - (1) LPG's storage and manifold system.
 - (2) Location and site plans.
 - (3) Schematic diagrams of the LPG supply system showing change-over valve, vaporiser, regulator, emergency shut-off valve, remote cut-off device, knock-out pot, pipe entry and all other required safety features.
 - (4) Plan and elevation views showing the following details:
 - (a) Location, quantity and capacity (in kg) of LPG cylinders.
 - (b) Locations of ancillary fixtures and fittings, e.g. vaporiser, regulators, emergency shut-off valve, change-over valves, remote cut-off device, knock-out pot, pipe entries, etc..
 - (c) Housing for the LPG cylinders, e.g. cabinets, fencing, compartment wall, etc..
 - (d) All openings (doors, air intakes, windows, drains, manholes, etc.) and exits adjacent to the LPG installation.
 - (e) Locations of hydrant, access way, access road, car parking area, building and boundary lines, source of ignition, etc..

- (f) Fire safety provisions, e.g. fire hose reel, fire extinguisher, sprinkler protection (if any), gas leak detector (if any), etc..
- (5) The following factors shall be taken into consideration when deciding on the practicality and reasonableness to use LPG:
 - (a) adequacy of ventilation;
 - (b) extent of usage of individual rooms;
 - (c) existing fire hazard;
 - (d) suitable means of escape; and
 - (e) firefighting equipment and provisions.

10.1.2 Design requirements

a. **Codes of practice and standards**

All cylinders and their ancillary fittings shall be designed, fabricated and tested in accordance with the accepted code or standard as stated in [*Annex 10.1A*](#).

b. **Fire stopping**

All pipes penetrating fire wall or floor slab shall be fire-stopped appropriately.

c. **Pressure**

No liquid LPG or LPG vapour at pressure exceeding 20psi (approximately 138kPa) shall be piped into any building.

d. **Fire extinguisher**

The LPG installation shall be provided with at least one approved portable B:C rating dry chemical fire extinguisher having a minimum capacity of 9kg.

e. **Warning sign/notice**

Warning signs/notices as shown in [*Diagram 10.1.2e*](#) shall be provided.

10.1.3 Outdoor LPG cylinder installation

a. **Siting of LPG cylinders**

LPG cylinders shall be located in accordance with the following requirements:

- (1) LPG cylinders shall be placed on a firm, clean, dry and level base. They shall be sited at ground level and a well-ventilated area where any gas leakage can safely and rapidly disperse. They shall not be placed close to any passageways or exits and shall not cause any obstruction or danger to the occupants during gas leakage or fire.
- (2) LPG cylinders shall not be located within 3m of any fire exit route of a building having only one exit. If the 3m distance cannot be complied with, a 2-hr fire-rated masonry wall of at least 1.8m high shall

be provided between the fire exit and the LPG installation so as to achieve the equivalent 3m horizontal distance.

- (3) LPG cylinders shall be located at least 1.5m horizontally away from any openings (windows, doors, air vents, balanced-flue outlets, etc.) of the building having more than one exit. If the 1.5m distance cannot be complied, a 2-hr fire-rated masonry wall of at least 1.8m high shall be provided between the openings and the installation so as to maintain a 1.5m horizontal distance.
- (4) A minimum distance of 3m shall be maintained between the edge of a vehicle parking lot.
- (5) LPG cylinders shall be located at least 5m horizontally from any mechanical air intake which is below any part of the manifold system and 1.5m from any mechanical intake which is above any part of the manifold system.
- (6) LPG cylinders can be installed below windows or openings provided that there is a minimum distance of 150mm between the top of any cylinder or the manifold system and the bottom of the windows or openings.
- (7) LPG cylinders of total capacity up to 600kg shall be located at least 1.5m from any uncovered opening that is below the level of the cylinders, such as drains, pits, openings to basements, etc.. For LPG cylinders having total capacity above 600kg, the distance from any uncovered opening shall be at least 3m.
- (8) LPG cylinders shall be located at least 3m away from any boundary and any fire engine accessway.
- (9) LPG cylinders shall be located at least 10m away from any fire hydrant.

b. Protection for LPG cylinder installation

LPG cylinder installations shall be protected in accordance with the following requirements:

- (1) LPG cylinders located in places accessible to the public shall be protected and locked against tampering and accidental damage by fencing of height not less than 1.8m, a suitable housing or a cabinet made of non-combustible material; and
- (2) there shall not be any corrosive, toxic or oxidizing materials located within 6 meters from the cylinder installation.

c. Safety provisions

The following safety provisions shall be adhered to for LPG cylinder installations:

- (1) For kitchen provided with fixed fire suppression system, activation of the system shall automatically shut off the supply of LPG to the kitchen.

- (2) Remote emergency shut-off valve shall be located at least 3m away from the edge of the installation. It shall be clearly marked and placed at a suitable height for easy access during emergencies. (see *Diagram 10.1.3d.(1)* and *10.1.3d.(2)*).
- (3) There shall be no ignition source within 3m from the cylinder installation.
- (4) All fixed electrical equipment within 1.5m of the installation shall be spark-proof and intrinsically safe in accordance with the relevant clause in SS 254.
- (5) Vaporisers shall not be installed inside the steel cabinet or within the same housing of the LPG cylinders. Wall-mounted vaporisers shall be located at least 1.8m above the ground and 600mm away from any LPG cylinder.
- (6) The distance between two separate manifold systems shall be at least 3m. If a 2-hr fire-rated wall is constructed, the distance between the two nearest cylinders can be halved.

d. Allowable quantities

(1) Eating outlets

LPG cylinder installation (for eating outlets) with capacity up to a maximum of 600kg by weight attached to a single manifold system installed adjacent to a building is allowed provided that the following requirements are fully complied with (see *Diagram 10.1.3d.(1)* and *Table 10.1A*):

- (a) a maximum of two steel cabinets is allowed for each installation, and each cabinet is allowed to house a maximum of 6 x 50kg LPG cylinders;
- (b) the separation distance between the two cabinets shall be at least 600mm;
- (c) the building is of non-combustible construction and the wall has a rating of at least 2-hr fire resistance; and
- (d) the maximum number of LPG manifold systems shall not exceed two per building.

(2) Industry buildings

LPG cylinder installation of capacity exceeding 600kg to a maximum of 1000kg by weight attached to a single manifold system can be used for industrial applications only, provided that the following requirements are fully complied with (see *Diagram 10.1.3d.(2)* and *Table 10.1A*):

- (a) a maximum of two steel cabinets is allowed for each installation and each cabinet is allowed to house a maximum of 10 x 50kg LPG

cylinders; and

- (b) a wall of at least 2-hr fire resistance rating or a spacing of 3m shall be provided to separate the LPG cylinders into two groups of maximum 10 x 50kg per group.

10.1.4 Indoor LPG cylinder installation

a. Location

- (1) LPG cylinder installation shall be properly located so as not to cause any obstruction to the fire escape and any danger to the public. Suitable access to the cylinder for emergency services shall be provided.
- (2) The edge of the installation shall be at least 3m from any boundary or any fire engine accessway.

b. Safety provisions

- (1) The location of the gas leak detector shall not be more than 300mm above the ground level and not more than 4m away from the edge of the installation and the point of consumption.
- (2) Remote emergency shut-off valve shall not be installed inside the compartment and shall be at least 1.5m away from the edge of the installation. It shall be clearly marked and at a suitable height to access during emergencies.
- (3) Fixed fire suppression system, if installed, shall be linked to the LPG cylinder installation in such a way that activation of the system shall automatically shut off the supply of LPG to the kitchen.
- (4) Vaporisers (where applicable) shall not be installed inside the compartment or within the same housing of the LPG cylinders.
- (5) The compartment shall only be used for LPG cylinder installation. No other usage is allowed.
- (6) The floor of the compartment shall be a smooth concrete base containing no opening or drain where vapour can accumulate and shall be level or slope down towards the ventilated external wall.
- (7) A ramp or sill of 250mm high shall be provided across the doorway (where applicable) into the compartment where LPG cylinders are installed to contain any heavy LPG vapour within the compartment.
- (8) All electrical connections and appliances shall be installed in accordance with the relevant clauses in SS 254.

c. LPG cylinder installation in separate compartment

LPG cylinders are allowed to be installed in a separate compartment on the ground floor, provided that the following requirements are complied with (see *Diagram 10.1.4c.* and *Table 10.1B*):

(1) Allowable quantity

- (a) A maximum of 400kg of LPG is allowed to be installed using a single manifold system inside a compartment. The quantity of cylinder is restricted to 8, regardless of the capacity of each cylinder (e.g. 2 groups of 4 x 50kg cylinders or 2 groups of 4 x 15kg cylinders).
- (b) The area or compartment in which the LPG cylinders are installed shall be sprinkler-protected. If the compartment is not sprinkler-protected, the quantity of LPG shall be halved (i.e. 200kg).
- (c) For commercial premises, the maximum number of LPG manifold system shall not exceed two per building.

(2) Compartment

- (a) The compartment shall have at least one external wall and there shall be no access from the compartment into the building.
- (b) Walls common to the compartment and the internal spaces of the building shall be 2-hr fire-rated and shall be of masonry construction.
- (c) Each compartment shall contain only one LPG manifold system.

(3) Ventilation

- (a) Doors shall have high and low level louvers and shall be opened outwards.
- (b) Natural ventilation is allowed if the total length of the compartment external wall is not less than 6m and the distance between the external wall and its opposite wall is not more than 3m. Otherwise, mechanical ventilation shall be provided.
- (c) High and low vents shall be provided on the external wall at just below ceiling level and above floor level. The total free area of the vents provided shall be at least 300cm²/m² of floor area.
- (d) The vent openings shall be kept free from obstruction and shall not discharge directly onto a public place, e.g. a pavement or path. It shall not be less than 5m from any air intake openings and shall be at least 1.5m horizontally away from any building opening which is below the vent opening level.
- (e) Where mechanical ventilation is used, air circulation shall be at least 0.3m³/min.m² of floor area. Discharge outlets shall be at least 1.5m horizontally away from any building opening which is located below the discharge level.

d. LPG cylinder installation in recessed area

Building recess used for housing LPG cylinder installation shall comply with

the following requirements (see *Diagram 10.1.4d.* and *Table 10.1B*):

(1) Design

- (a) The maximum depth of the recess shall be not more than 1m deep.
- (b) The floor, ceiling and the dividing walls between the recess and the internal spaces of the building shall be brick, concrete or other non-combustible materials shall have a fire resistance rating of not less than 2 hours.
- (c) Access to the recess shall only be from the external of the building.

(2) Location

- (a) The recess shall be at ground floor and shall be for the exclusive use of housing LPG cylinders.
- (b) The recess shall not be located within 3m of any fire exit route from a building that has only one designated means of exit. If the 3m distance cannot be complied with, a 2-hr fire-rated masonry wall shall be provided between the fire exit and the installation so as to achieve the 3m horizontal distance.
- (c) The recess shall be located at least 1.5m from any horizontal openings (windows, doors, air vents, balanced-flue outlets, etc.) of the building having more than one designated means of escape, measured horizontally from the nearest LPG cylinder. If the 1.5m distance cannot be complied with, a 2-hr fire-rated masonry wall shall be provided between the openings and the installation so as to achieve the 1.5m horizontal distance.
- (d) The recess shall be located at least 3m from ignition source.
- (e) A minimum horizontal distance of 3m shall be maintained between the nearest edge of a vehicle parking lot to the recessed area.
- (f) Recessed area located below windows or openings shall maintain a minimum distance of 150mm between the top of the recessed area or any part of the manifold system (piping, vaporiser, etc., whichever is higher) and the bottom of the windows or openings.
- (g) LPG cylinders shall be located at least 5m horizontally from any mechanical air intake which is below any part of the manifold system and 1.5m from any mechanical intake which is above any part of the manifold system.

(3) Allowable quantity

- (a) A maximum of 400kg of LPG is allowed to be installed using a single manifold system inside the recessed area. The quantity of cylinder is restricted to 8, regardless of the capacity of each cylinder (e.g. 2 groups of 4 x 50kg cylinders or 2 groups of 4 x 15kg cylinders).

- (b) The space or compartment where the pipework and ancillary fittings are installed shall be sprinkler-protected (except for the recessed area). If not, the LPG quantity shall be halved (200kg).
- (c) For commercial premises, the maximum number of LPG manifold system shall not exceed two per building.

(4) Safety

Any pipe penetration on the walls of the recess area shall be suitably fire-stopped to maintain the 2-hr fire resistance rating of the walls.

(5) Ventilation

Permanent unobstructed high and low ventilation openings, not less than 300cm²/m² of recess floor area, shall be provided for venting the recess space to the external of the building.

10.1.5 Gas leak detection system and other requirements

- a. Gas leak detection system shall be provided within area, room or compartment involving LPG piping system, regardless whether the mentioned spaces are naturally ventilated, mechanically ventilated or air-conditioned. The gas leak detection system shall, upon detection, automatically shut off gas supply and sound the alarm (see [Cl.A2.3](#) of [Annex 10.1A](#) on Gas Leak Detection).
- b. A fail-safe central solenoid isolation valve interlocked with the gas leak detection system shall be installed at the main pipe immediately outside the metal cabinet.
- c. All flexible pigtail tubings shall be of heavy duty type, UL listed and integrated with one-way check valve.
- d. If vapour manifold is installed for temporary use when vaporiser is under repair or replacement, its design shall adhere to the similar design criteria for liquid line.
- e. The LPG installation (i.e. including all pipings, manifold system, devices/equipment such as vaporiser and pressure release valves etc.) shall be separated with 2-hr fire-rated masonry wall from other area and all shop units.
- f. The installation shall be protected with 2-hrs fire-rated roof cover if there is any other equipment such as air-condition condensing unit etc. installed above it.
- g. All electrical fittings shall comply with IEC 60079, including Parts 10, 14 and 17, i.e. electrical installations in hazardous areas.
- h. Hose reel coverage shall be provided.
- i. The LPG installation shall be within 45m range from fire engine access road and fire hydrant is within 50m range from the fire engine access road.
- j. Where LPG installation is located within a back-lane, public street or service

road, it shall be accessible to firefighters from both ends of the back-lane, public street or service road.

10.1.6 Reduced separation distances between LPG storage and boundaries

- a. The separation distances stipulated under *Cl.10.1.3a.(2)*, *Cl.10.1.3a.(3)* and *Cl.10.1.3a.(8)* can be reduced as follows provided all the conditions stipulated under are fulfilled:
 - (1) at least 1.5m separation between LPG installation and the common boundary lines of the two abutting shop units;
 - (2) at least 3m separation between LPG installation and the opposite property;
 - (3) at least 1.5m separation between LPG installation compartment and the exit, if this exit is the only exit for the shop unit; and
 - (4) at least 1.5m separation between LPG installation and the final discharge of exit staircase, if this staircase is the only exit staircase serving upper or basement levels.
- b. Conditions for reduced separation distances between LPG installation and boundaries
 - (1) The LPG storage shall be fully protected with masonry wall including 2-hrs fire-rated roof cover; access door shall also be 1-hr fire-rated with low level air gap of 75mm for ventilation purpose; the masonry wall facing abutting shop unit shall be extended at least 300mm higher than the entire LPG installation.
 - (2) In addition to *Cl.10.1.5a.*, gas leak detector(s) shall be provided at the LPG installation that shall upon detection, automatically shut off the gas supply, sound the alarm and activate the strobe light located next to the LPG storage (with “Gas Leak” indication beside the strobe light).
 - (3) The minimum alarm sounding duration shall be 3 mins and the strobe light (blue) shall flash continuously.
 - (4) Red background signage with white lettering of 50mm in size with the following details shall be placed at the LPG storage compartment and at the emergency shut-off valve pull box.

GAS LEAK WARNING

When strobe light and/or alarm soundings is
activated, keep away and call 995

Gas supplier's contact: 6xxxxxxx

CHAPTER 10

- (5) Emergency shut-off switch for the isolation valve shall be provided beside the emergency shut-off valve pull box.
- (6) The total number of gas cylinders shall be limited to 6.

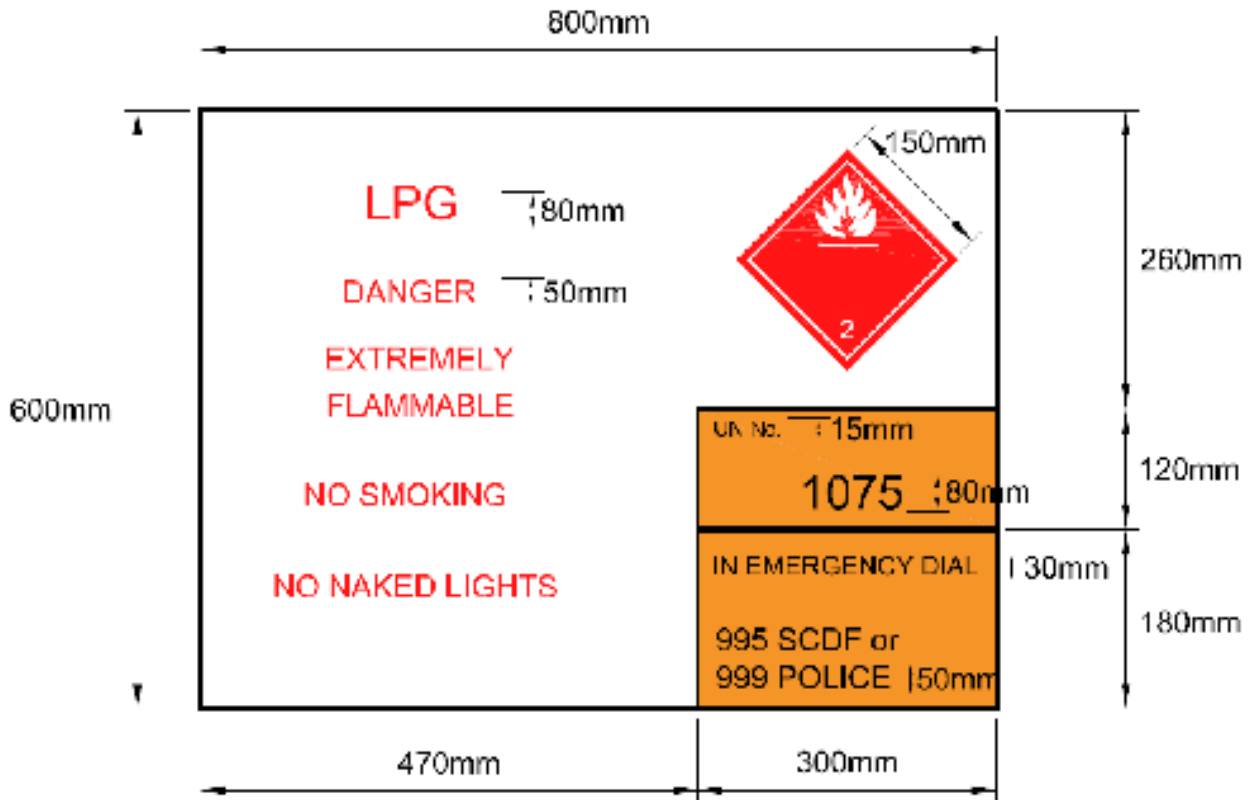

[Diagram 10.1.2e. : Warning sign/notice for LPG cylinder installation](#)

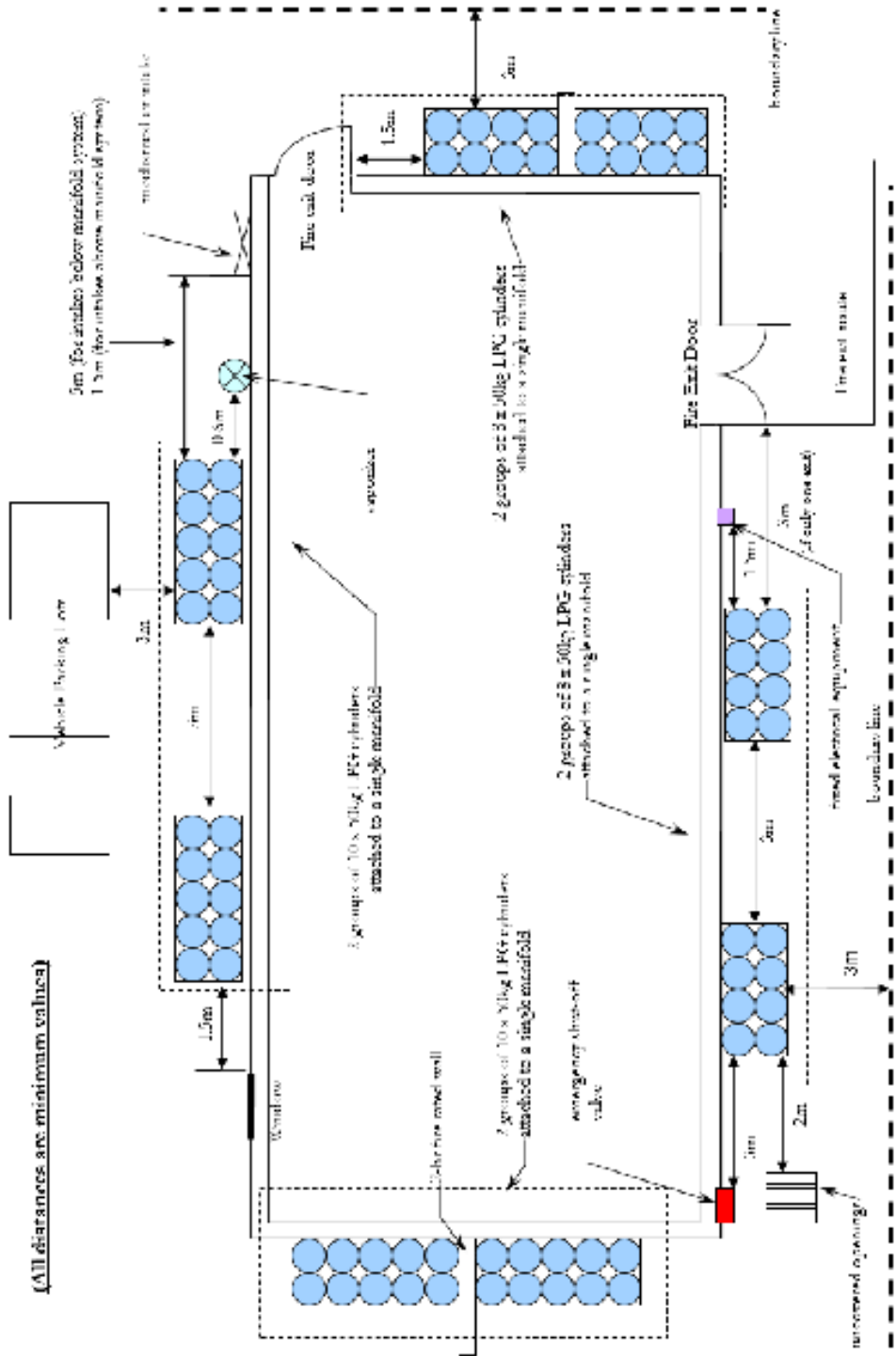
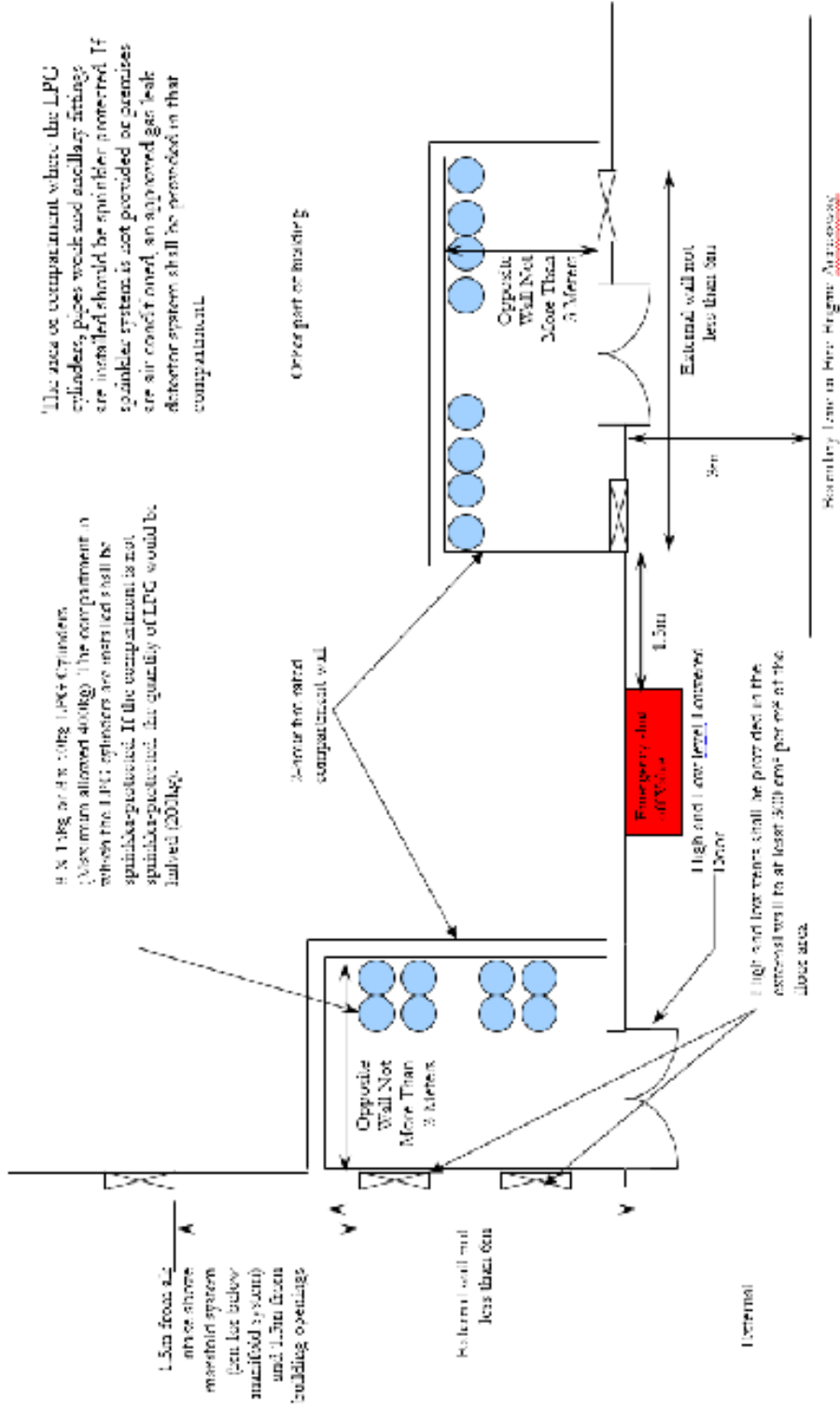

Diagram 10.1.3d.(2) : LPG cylinder installation for industrial applications



The size of compartment where the LPG cylinders, pipes work and auxiliary fittings are installed should be spinifer protected. If spinifer system is not provided or provided are air conditioned, an approved gas leak detector system shall be provided in that compartment.

If a 1.5m and 2.0m high fireproof door (Maximum allowed height) The compartment in which the LPG spinifer are installed shall be spinifer-protected. If the compartment is not spinifer-protected, the quantity of LPG would be limited (200kg).

Diagram 10.1.4c. : Indoor LPG cylinder installation in separate compartment

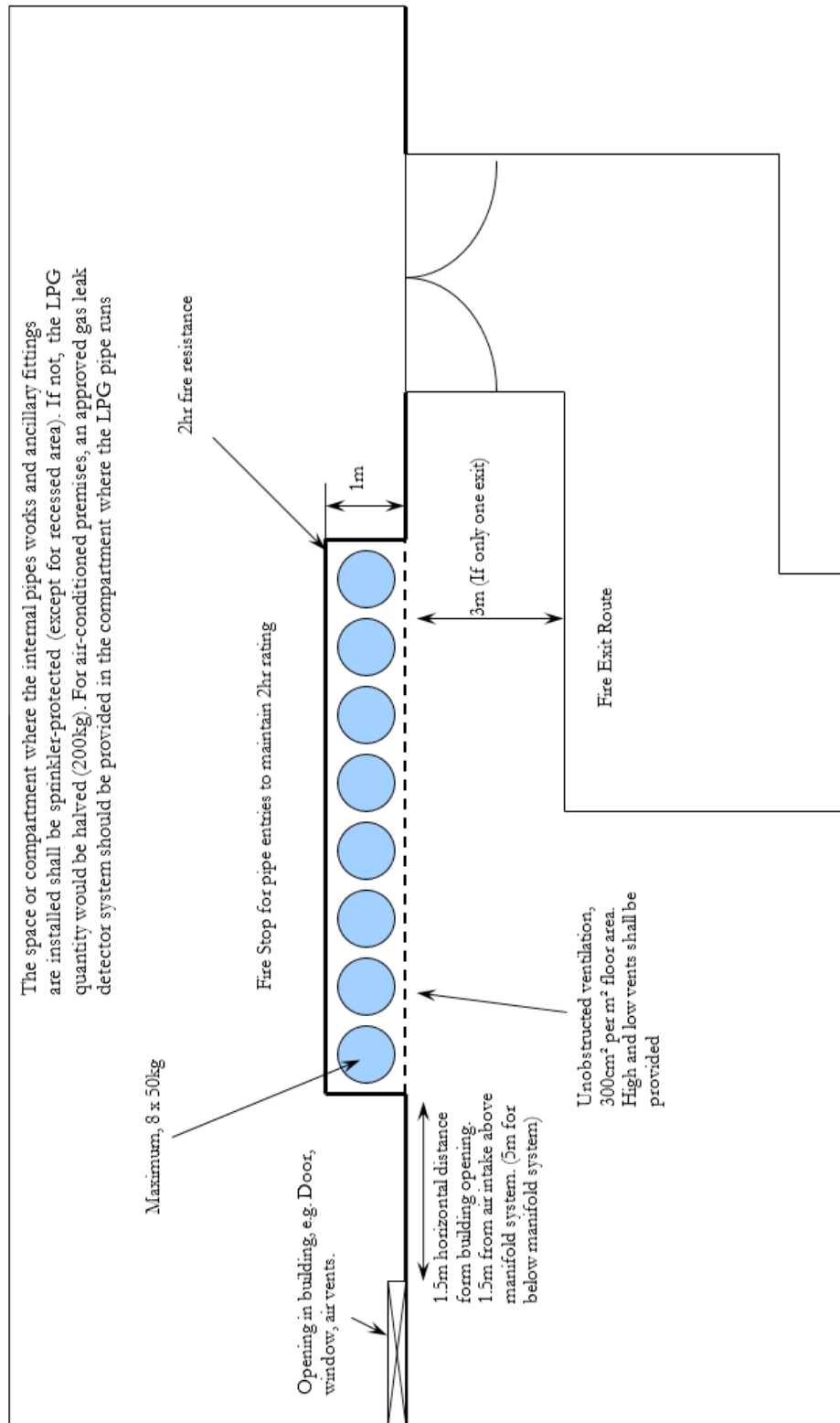

Diagram 10.1.4d. : LPG cylinder installation in recessed area

TABLE 10.1A : VARIOUS DISTANCES FOR OUTDOOR LPG INSTALLATIONS

TABLE 10.1A : VARIOUS DISTANCES FOR OUTDOOR LPG INSTALLATIONS										
LPG quantity	(kg)	(m)	(no.)	(no.)	(no.)	(m)	(m)	(m)	(m)	(m)
Not more than 600kg		3m minimum	2 maximum	6 maximum	12 maximum	0.6m minimum	1.5m minimum	3m min. (one exit only) 1.5m min. (more than one exit)	1.5m minimum	5m min. (intakes below manifold system) 1.5m min. (intakes above manifold system)
										3m min. (no fire-rated wall) 1.5m min. (with 2-hr fire-rated wall)
600kg to 1000kg (Industrial applications only)		3m minimum	2 maximum	10 maximum	20 maximum	3m minimum or 2-hr fire-rated wall	2m minimum	3m min. (one exit only) 1.5m min. (more than one exit)	1.5m minimum	5m min. (intakes below manifold system) 1.5m min. (intakes above manifold system)
										6m min. (no fire-rated wall) 3m min. (with 2-hr fire-rated wall)
										Distance between manifold systems
										Distance from mechanical air intake
										Distance from fire exit route
										Horizontal distance from windows, doors, vents, balance flue outlets, etc.
										Distance from drains, pit, manhole, oil tank bund wall, basement opening etc.
										Distance from cabinet / cluster
										Distance from manifold systems
										Distance from vehicle parking lot

TABLE 10.1B : TECHNICAL DETAILS FOR INDOOR LPG INSTALLATIONS

Location of LPG	Quantity Allowed (kg)	Fire rating of compartment (hr)	Distance from Open flame, ignition source (m)	Sprinkler / Gas Leak detector	Natural Ventilation	Mechanical Ventilation (m ³ /min)	Distance from exits (m)	Min. Dist. Of discharge from mech. air intake (m)
Separate Compartment	400kg max. (8 x 50kg or 8 x 15 kg) Maximum 8 cylinders	2	Not applicable	Sprinkler required else only max. 200kg of LPG is allowed If no sprinkler or if air-conditioned, gas leak detector is required	a) 300cm ² opening per m ² of compartment floor area b) high and low vents shall be provided c) min. length of external wall : 6m	0.3 per meter square of compartment floor area	1.5m	1.5m min. (intakes above manifold system) 5m min. (intakes below manifold system)
Recessed Area	400kg max. (8 x 50kg or 8 x 15 kg) Maximum 8 cylinders	2	3	Sprinkler required (excluding recessed area) else only max. 200kg of LPG is allowed If no sprinkler or if air-conditioned, gas leak detector is required (excluding recessed area)	a) 300cm ² opening per m ² of compartment floor area b) high and low vents shall be provided	Not applicable	3m if only one exit, otherwise 1.5m	1.5m min. (intake above manifold system) 5m min. (intakes below manifold system)

10.2 SOLAR PHOTO-VOLTAIC (PV) INSTALLATION

10.2.1 General

This set of fire safety requirements shall be applicable to roof-mounted PV installations.

10.2.2 Means of access

- a. For PV installations on the roof, at least one exit staircase shall be provided. Where the area of non-habitable roof is large and one-way travel distance to the exit cannot be met, an additional cat ladder or ship ladder adequately separated from the exit staircase, in accordance with *Cl.2.3.12* and leading to the circulation area of the floor below shall be provided.
- b. For existing buildings which are carrying out the installation of PVs on the roof level where the provision of single exit staircase is not feasible, a portable sturdy ladder to the roof access shall be provided. Single storey buildings with roof height not more than 12m or inaccessible pitched roof up to 24m from grade level are not required to provide a sturdy ladder, if there is a fire engine accessway fronting this installation.
- c. The computation of travel distance for roof areas which are open to the sky for any purpose group (except PG I) can be based on the requirement for sprinkler-protected compartments/ buildings.
- d. All access hatches, if provided, shall be readily accessible from the roof. The access hatch opening shall have a minimum clear width of 1m in diameter.

10.2.3 Fire resistance of PV modules

- a. The standard IEC 61730-2 stipulates the fire test for PV modules. The characteristics assessed in the fire test establish the fundamental fire resistance of PV modules mounted over an existing roof. A minimum fire resistance rating Class C shall be provided for any roof-mounted PV module.
- b. System components associated with the PV modules, such as wirings and switchboard assemblies, shall comply with the installation requirements as stipulated in SS CP 5.

10.2.4 Design and installation criteria

- a. The sub-array for the PV installations shall be limited to a maximum size of 40m by 40m.
- b. A clearance of 3m around the access/hatch opening and in front of exit door (of exit staircase) shall be provided.
- c. For a roof without perimeter parapet/railing, a clear width of not less than 2.5m shall be maintained along the perimeter aisles/gangways. For a roof with perimeter parapet/railing of height not less than 900mm, a clear width of not

less than 1.5m shall be provided along the perimeter aisle/gangway.

- d. There shall be a minimum of 1.5m separation between arrays.
- e. There shall be no storage or services below the PV installation.
- f. PV modules, wirings, switchboard assemblies and other equipment shall not cover any ventilation system on the roof (e.g. smoke control/ extraction systems or air well).

(See *Diagram 10.2.4*)

10.2.5 Emergency disconnection

- a. Manual emergency shut-off system for the disconnection of the PV modules shall be provided on both the AC-power side (typically where inverters are placed) and the switch room side.
- b. Operating instructions for the emergency shut off system shall be placed at a height of between 1.5m to 2m from the floor and clearly displayed near to the emergency shut-off system.
- c. Simplified site plan with the position of PV modules and system circuit diagrams shall be placed at a height of between 1.5m to 2m from the floor and displayed close to the access openings or the exit staircase from the roof.

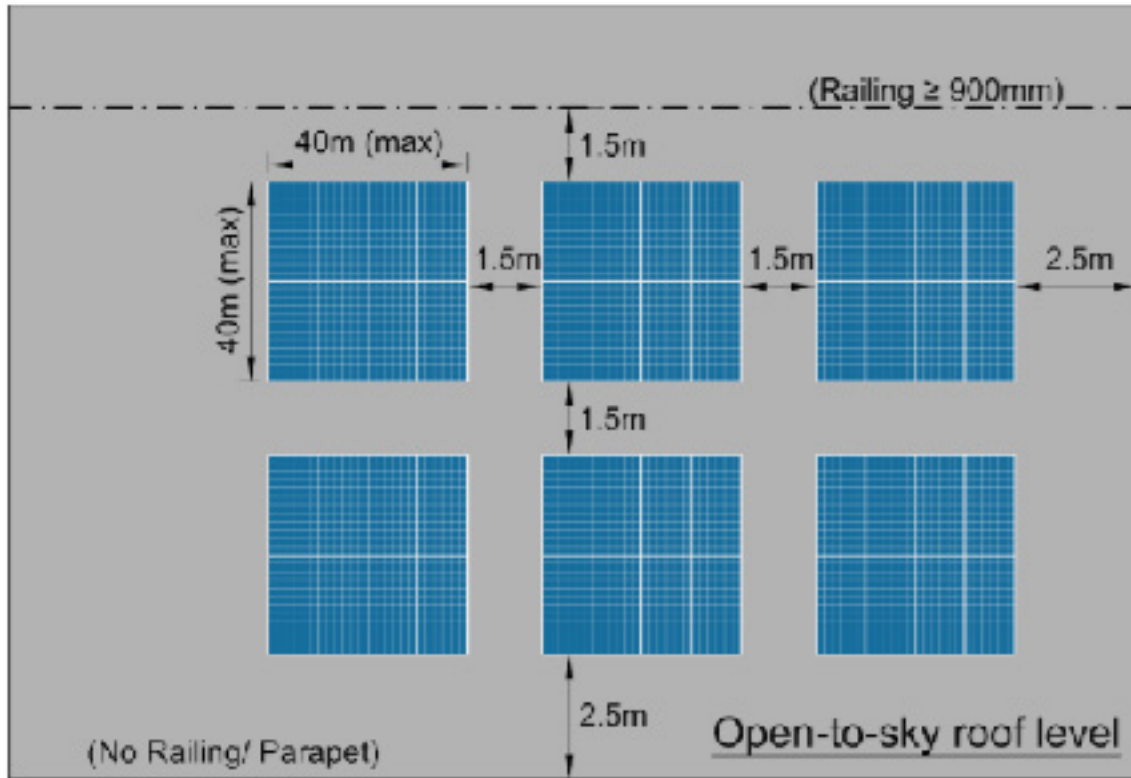

[Diagram 10.2.4 : Solar Panels Installation Criteria](#)

ANNEX 10.1A**STANDARDS AND SPECIFICATIONS FOR LPG CYLINDER INSTALLATIONS****A1.0 STANDARDS**

The following standards for LPG cylinders and ancillary fittings shall be complied with:

TABLE 1 : STANDARDS FOR LPG CYLINDERS & FITTINGS			
S/N	ITEM	STANDARDS	PLS LISTING
1	Cylinder	SS 99	Yes
2	Cylinder Fittings		
	a) Flexible Hose	SS 233	Yes
	b) Regulator	SS 281, BS 3016, UL144	Yes
	c) Cylinder valve	SS 294	Yes
3	Gas Leak Detector	BS EN 50054, BS EN 50057 and BS 5345 Part 1 and 3	Yes

A2.0 SPECIFICATIONS**A2.1 LPG Cylinder Fittings****a. Flexible hoses**

- (1) Hoses or flexible connectors used to supply LPG to utilization equipment or appliances shall be installed in accordance with the relevant clauses of NFPA 54 and NFPA 58. The hose shall be securely connected to the appliance. The use of rubber slip ends without hose clips shall not be permitted for domestic cylinders.
- (2) Hoses shall be tested and passed the performance criteria in accordance with SS 233.

b. Regulators

Regulators shall comply with the standards as specified in the table above.

c. Over pressure protection device

- (1) An over pressure protection device is a device to protect the downstream installation and shut off the gas flow if the outlet pressure exceeds the set limit.
- (2) In general, a regulator with over pressure protection device shall be designed to achieve the following:
 - (a) ensuring reliable and continuous supply of LPG;
 - (b) protecting downstream system against over pressure; and
 - (c) protecting against failure of any regulating device.

- (3) Setting of over pressure protection device shall not be more than 30% of maximum operating pressure.

d. Valves

(1) Cylinder valves

Cylinder valves shall comply with the standards as specified in the table above.

(2) Safety valves

- (a) Hydrostatic relief valves designed to relieve the hydrostatic pressure that might develop in sections of liquid piping between two isolating valves shall be installed in each section. Hydrostatic valves shall comply with UL 132, Standard for Pressure Relief Valves for LPG.
- (b) Emergency shut-off valve shall be provided after the knockout pot. The emergency shut-off valve shall be linked to a release mechanism so that the valve can be closed from a safe distance of at least 3m from the LPG cylinders. The emergency shut-off valve may incorporate fusible element which melts at not more than 250° when exposed to fire, allowing the emergency shut-off valve to close by itself.
- (c) An accessible gas shutoff valve shall be provided at the upstream of each gas pressure regulator. Where two gas pressure regulators are installed in series in a single gas line, a manual valve shall not be required at the second regulator.
- (d) Main gas shut-off valves controlling several gas piping systems shall be prominent and readily accessible for operation and properly installed so as to protect it from physical damage. They shall be marked with a metal tag or other permanent means attached by the installing agency so that the gas piping systems supplied through them can be readily identified.
- (e) An exterior shut-off valve to permit turning off the gas supply to each building in an emergency shall be provided and plainly marked.

e. Piping

- (1) Pipe design and specifications shall be in accordance with the relevant clauses in NFPA 54 and NFPA 58. No polyethylene material is allowed to be used for the piping system except for necessary industrial applications.
- (2) Pipe material shall be tested and certified according to recognised ASTM or British Standard. The pipe supplier shall produce Mill certificates.
- (3) The manifold and main LPG supply pipeline shall be welded together as far as practicable. Welders for the piping work must be qualified and

certified by a recognised body.

- (4) Pipelines pressure test shall be witnessed and certified by a Professional Engineer (Mechanical).
- (5) The liquid LPG pipelines shall be painted in “Blue” and the vapour LPG pipelines in “Yellow” with the marking of the word “LP-Gas” at intervals of not more than 3m.
- (6) When connecting additional gas utilisation equipment to a gas piping system, the existing piping shall be checked to determine if it has adequate capacity. If inadequate, the existing system shall be enlarged as required, or separate gas equipment of adequate capacity shall be provided.

f. Pigtail

- (1) Pigtail shall include a 6mm flexible hose or tube, a 6mm tee-check valve or excess flow valve and a 6mm ball valve.
- (2) Flexible hose shall be fabricated of materials resistant to LPG reaction both in liquid and vapour state. It shall be designed for a minimum bursting pressure of 1750 psi (121 bar) and working pressure of 350 psi (24 bar). The hose shall be marked “LPG” at intervals of not more than 3m.
- (3) The tee-check valve shall be Underwriters Laboratories Inc. (UL) listed or it shall comply with other recognised/approved standard.
- (4) The ball valve shall be rated to at least 600 psi (41 bar).

g. Pressure gauge

- (1) Each bank of LPG cylinder manifold shall have a pressure gauge.
- (2) For high-pressure section, the gauge shall have a range of 0 to 300 psi (0 to 20.1 bar)
- (3) For low-pressure section, the gauge shall have a range of 0 to 50 psi (0 to 3.45 bar)

h. Vaporiser

- (1) Vaporisers, where applicable, shall be constructed in accordance with the applicable provision of NFPA 58, ASME Code or other recognised pressure vessel codes and standards for a design pressure of 250 psi (17.24 bar) and shall be permanently and legibly marked with:
 - (a) markings required by the Code;
 - (b) the allowable working pressure and temperature for which it is designed; and
 - (c) the name or symbol of the manufacturer.

- (2) Vaporisers shall be provided with a suitable automatic means to prevent the passage of liquid through the vaporiser to the vapour discharge piping. This feature shall be permitted to be integrated with the vaporiser or otherwise provided in the external piping.
- (3) Vaporisers shall have a manual shut-off valve and an automated valve (e.g. thermostatic, magnetic or float) which closes in the event of power failure or overload.
- (4) Vaporisers shall have relevant temperature control and the necessary safety features.
- (5) Vaporisers shall have a pressure relief valve set at 250 psi (17.24 bar) with the release point directed upward.

i. Knock-out pot

The knockout pot shall have at least two drain valves. The drain shall end at ground level and plugged at the end.

j. Gas meters

- (1) Installation and application of gas meters shall be in accordance with the relevant clauses in NFPA 54 and shall be able to take a pressure of 20 psi (1 psi = 6.895 kPa).
- (2) Gas meters shall be selected for the maximum expected pressure and permissible pressure drop.
- (3) Vapour meters of the tin or brass case type of soldered construction shall not be used at pressure in excess of 1 psi (7 kPa).
- (4) Vapour meters of the die cast or iron case type shall be permitted to be used at any pressure equal to or less than the working pressure for which they are designed and marked.
- (5) Gas meters shall be located in ventilated spaces readily accessible for examination, reading, replacement or necessary maintenance.
- (6) Gas meters shall not be placed where they will be subjected to damage, such as adjacent to a driveway, under a fire escape, in public passages, halls or where they will be subjected to excessive corrosion or vibration.
- (7) Gas meters shall be located at least 1m from sources of ignition.
- (8) Gas meters shall not be located where they will be subjected to extreme temperatures or sudden extreme changes in temperature. Meters shall not be located in areas where they are subjected to temperatures beyond those recommended by the manufacturer.
- (9) Gas meters shall be supported or connected to rigid piping so as not to exert a strain on the meters.
- (10) Gas meters shall be protected against over pressure, back pressure, and

vacuum, where such conditions are anticipated.

k. Strainers

Strainers shall be designed to minimise the possibility of particulate materials clogging lines and damaging meters or regulators. The strainer element shall be accessible for cleaning.

A2.2 Electrical bonding and grounding

- a. Electrical circuits shall not utilise gas piping or components as conductors.
- b. All electrical connections between wiring and electrically operated control devices in a piping system shall conform to the requirements of SS 254.
- c. Any essential safety control (in the vaporiser) depending on electrical current as the operating medium shall be of a type that will shut off (fail safe) the flow of gas in the event of current failure.

A2.3 Gas leak detection

- a. Gas leak detectors shall be connected to a localised alert alarm, emergency shut-off valve as well as the kitchen exhaust systems. The gas supply safety shut-off valve system shall also be interlocking with the kitchen automatic fire suppression system (see diagram below).

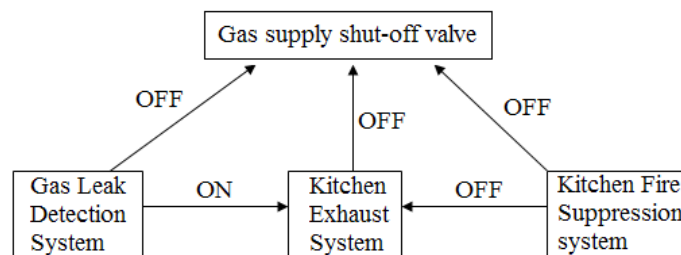

- b. LPG pipe installation shall not be permitted in the following areas:
 - (1) in the ground under concrete flooring within building;
 - (2) under building under building foundations;
 - (3) within lift shafts and cavity walls;
 - (4) in compartments or ducts dedicated for electrical switchgears, transformers or air-conditioning ducts;
 - (5) in refrigeration chambers, coldrooms, air handling rooms and ventilation or other hazardous materials;
 - (6) adjacent to pipes and vessels containing flammable, oxidizing, corrosive and other hazardous materials; and

CHAPTER 10

- (7) in fire lift lobby, FCC, smoke-stop lobbies, fire pump rooms, firefighting water tank rooms, sprinkler control valve rooms, riser ducts, areas of refuge, protected corridors, exit staircases, bedrooms and other occupied area, etc..
- c. Proper metal pipe sleeve shall be installed for the gas pipes running in enclosed non-ventilated areas or basement floor, and at least one end exposed directly to the exterior open safe space (it can be used to facilitate the gas leak detection system).
- d. Gas pipe running vertically shall be enclosed within a protected riser shaft and be fully fire separated from other M&E risers. Ventilation opening shall be provided for such gas riser.

ANNEX 10.1B
CONDITIONS FOR INDOOR STORAGE/USE OF LPG
IN EATING OUTLETS

B1.0 DEFINITION**a. Eating outlet**

“Eating outlet” refers to shop unit/units operated as food outlet, food court, eating place, restaurant, hawker centre or coffee shop.

b. Food stall

“Food stall” refers to stall operated by independent operator within an eating outlet.

B2.0 GENERAL REQUIREMENTS

All eating outlets shall not use or store LPG cylinders within building unless all of the following conditions are fulfilled:

- a. The eating outlet is located on or above ground level.
- b. The eating outlet is naturally ventilated.

B3.0 ALLOWABLE QUANTITY

- a. The maximum allowable quantity of LPG shall be limited to 2 x 15kg cylinders (including standby cylinder) per food stall.
- b. The total capacity for each eating outlet shall not be more than 200kg.

B4.0 FIRE SAFETY REQUIREMENTS**B4.1 Compartmentation**

- a. The eating outlet shall be separated by fire-resistant walls (1-hr fire resisting rating for sprinkler-protected building and 2-hr for non-sprinkler-protected building) from other areas.
- b. Stalls within food court or coffee shop shall be separated from each other with 1-hr fire-resisting side-walls.

B4.2 Connection of LPG cylinders

Each cylinder shall be connected to cooking hob/stove with flexible hose. The LPG cylinders shall not be connected together with manifold system.

B4.3 LPG cabinet

- a. LPG cylinders shall be housed in a 2.5mm thick steel cabinet. There shall be not more than 2 x 15kg cylinders in each cabinet.
- b. The cabinet shall be placed directly on a firm floor.
- c. The cabinet shall be adequately ventilated with openings at the bottom of the cabinet.
- d. The cabinet shall always be kept free of any combustible materials.

B4.4 Gas leak detection system

- a. Gas-leak detection system (approved by recognised certifying bodies, e.g. PSB, UL or FM) shall be provided (be supplied directly from the building electrical power supply). The system shall be linked to shut off the LPG supply automatically and activate local alert alarm. The gas-leak detector shall be located at low level and near to the possible leak areas such as the connecting hoses, LPG cylinder cabinets, etc..
- b. If kitchen automatic fire suppression system is provided, it shall also be linked to shut off the LPG supply automatically.

CHAPTER

11

**REGULATED FIRE SAFETY
PRODUCTS & MATERIALS**

CHAPTER 11

REGULATED FIRE SAFETY PRODUCTS & MATERIALS

11.1 GENERAL

This Chapter provides a list of building materials and equipment, also known as fire safety products and materials, regulated by the SCDF. It includes the acceptable test standards, product certification schemes and surveillance regime for these products and materials, which are the technical requirements of the Product Listing Scheme. For administrative requirements of the Product Listing Scheme, refer to [*Annex 11A*](#).

11.2 DEFINITION

11.2.1 Product Listing Scheme (PLS)

Product listing scheme refers to a third party certification scheme administered by SCDF for regulated fire safety products and materials.

11.2.2 Certificate of Conformity (CoC)

Certificate of Conformity refers to a certificate, which comes with a validity period, issued by Certification Bodies (CBs) for a fire safety product that meets the products testing standards and certification requirements. The product will be listed in a product directory, which can be found on the CB's website, for reference and verification since a CoC can be terminated before its expiry.

11.2.3 Declaration of Compliance (DoC)

Declaration of Compliance refers to a declaration of information associated with or related to a batch of fire safety products with CoC.

11.2.4 Mutual Recognition Arrangement (MRA)

Mutual Recognition Arrangement (MRA) refers to the global network of conformity assessment bodies recognising each other's test report.

11.2.5 Scheme Type 1b (Scheme 1b)

Scheme Type 1b refers to the Scheme Type 1b specified in ISO/IEC 17067. It consists of type testing of a sample of a production and subsequent batch inspection. Regulated fire safety products certified under Scheme Type 1b are issued with product labels which are also displayed on the products.

11.2.6 Scheme Type 2 (Scheme 2)

Scheme Type 2 refers to the Scheme Type 2 specified in ISO/IEC 17067. It consists

of type testing of a sample and market surveillance. Market surveillance is conducted and samples of the product from the market are assessed for ongoing conformity.

11.2.7 Scheme Type 5 (Scheme 5)

Scheme Type 5 refers to the Scheme Type 5 specified in ISO/IEC 17067. It consists of testing and assessment of the quality system involved. Surveillance of the quality system is conducted and samples of the product from either the market or at the point of production, or both, are assessed for ongoing conformity. Regulated fire safety products certified under Scheme Type 5 (Discrete System) are issued with product labels which are also displayed on the products.

11.2.8 Discrete System

Products which are classified as discrete systems are issued with product labels by CBs which can be displayed on the products. Examples of such products include hydrants, landing valves and fire extinguishers.

11.2.9 Non-discrete system

Products which are classified as non-discrete system are issued by CBs with DoC certificates to suppliers. Examples of such products include internal partition system and floor system.

11.3 ASSESSMENT AND VALIDATION

11.3.1 Assessment of modification to certified fire safety products and materials

- a. The fire safety products and materials shall be installed in the manner as the tested prototype described in the test report. Any modifications or deviations to the tested prototype shall be supported by a report prepared by a local or an overseas test laboratory accredited or recognised by SAC.
- b. All items of regulated fire safety products and materials shown in [Table 11A](#) shall be certified under the respective certification scheme.

11.3.2 Validity of test reports for regulated fire safety products and materials

- a. Test report(s) shall be valid for 5 years at the point of listing for products listed under Scheme Type 5 (Discrete system) and Scheme Type 1b which are issued with product labels.
- b. Test report(s) shall be valid for 10 years at the point of listing for products listed under Scheme Type 5 (Non-discrete system) which are issued with DoC.
- c. Test report(s) shall be valid for 5 years at the point of listing for products listed under Scheme Type 2 (Discrete system) and valid for 10 years at the point of listing for products listed under Scheme Type 2 (Non-discrete system).

11.3.3 Validity of CoC for regulated fire safety product and materials

- a. CoC for a regulated fire safety product shall be valid for 5 years. Under the PLS, a fire safety product supplier shall obtain a CoC for their product before it is used for building construction in Singapore. The issuance of CoC for regulated fire safety products listed under the PLS is solely based on compliance of stipulated test performance standard of the product certified in the test report issued by a local or an overseas test laboratory accredited or recognised by SAC via MRA.
- b. Fire safety products and materials used in fire safety works shall be certified by a local certification body accredited by SAC.
- c. Fire safety products and materials used in fire safety works shall be of the standards specified at the point of plans submission to the SCDF.
- d. A CoC is considered valid if it is active at the date at which the Notice of Approval (NoA) is issued by the SCDF.

TABLE 11A : LIST OF REGULATED FIRE SAFETY PRODUCTS & MATERIALS

S/N	Products / Materials	Acceptable Standards	Certification Scheme	Surveillance Regime	
				Testing	Factory/Site Inspection
1.	Fire alarm				
1a.	Fire alarm panel	(a) EN 54-2; and (b) EN 54-4; and (c) SS CP 10.	Scheme 5, or Scheme 1b (Labels issued)	Scheme 5 – At least once annually or by trigger (every 200 labels) Critical electrical (frequency, voltage) input and output; verify design deviation; verify functionality; verify visual & audio indicators)	Scheme 5 – At least once annually or by trigger (every 200 labels)
1b.	Home fire alarm device (i.e. smoke detectors) ⁽¹¹⁾	(a) EN 14604, or (b) AS 3786, or (c) UL 217. (Refer to Cl.6.3.6 for more information)	Scheme 2 (No label issued)	Scheme 1b – Batch testing Critical electrical (frequency, voltage) input and output; verify design deviation; verify functionality; verify visual & audio indicators)	Scheme 1b - Not Applicable
2.	Fire pump	(a) AS 2941, or (b) UL 448, or (c) FMRC Class 1311, or (d) FMRC Class 1319	Scheme 5 (Labels issued)	Annual surveillance test (Applicable for products that had done their full testing locally)	Not Applicable
				AS – Annual testing FM/UL – Annual testing (Submission of reports shall include surveillance inspection & testing.)	At least once annually

TABLE 11A : LIST OF REGULATED FIRE SAFETY PRODUCTS & MATERIALS

S/N	Products / Materials	Acceptable Standards	Certification Scheme	Surveillance Regime	
				Testing	Factory/Site Inspection
3.	Fire-rated partition ⁽¹⁶⁾ Materials are listed under BS 476-4 or BS 476-11 or EN 13501-1 (min. A2 class) under PLS Scheme 2				
3.1	Compartment wall	(a) BS 476-22 or EN 1364-1 or AS 1530-4 or ASTM E119 or ISO 834-8; and (b) Timber products: See section on cross/glued laminated timber.	Scheme 5 (DoC ⁽¹⁾ issued)	Site inspection triggered by DoC (every 3500m ²) Annual surveillance test on material under Scheme 2	At least once annually
3.2	Protected shaft enclosing lift ⁽²⁾	(a) BS 476-22 or EN 1364-1 or AS 1530-4 or ASTM E119 or ISO 834-8; and (b) BS 5234-2; and (c) BS EN 520 (for gypsum plaster board); and (d) ISO 1896 (for calcium silicate or cement board); and (e) Cyclic loading & dynamic test as specified under Cl 3.8.8	Scheme 5 (DoC issued)	Site inspection triggered by DoC (every 3500m ²) Annual surveillance test on material under Scheme 2	At least once annually
3.3	Protected shaft enclosing staircase or services	(a) BS 476-22 or EN 1364-1 or AS 1530-4 or ASTM E119 or ISO 834-8; and (b) BS 5234-2; and (c) EN 520 (for gypsum plaster board); and (d) ISO 1896 (for calcium silicate or cement board)	Scheme 5 (DoC issued)	Site inspection triggered by DoC (every 3500m ²) Annual surveillance test on material under Scheme 2	At least once annually

TABLE 11A : LIST OF REGULATED FIRE SAFETY PRODUCTS & MATERIALS

S/N	Products / Materials	Acceptable Standards	Certification Scheme	Surveillance Regime	
				Testing	Factory/Site Inspection
4.	Fire-rated floor ⁽¹⁶⁾ Materials are listed under BS 476-4 or BS 476-11 or EN 13501-1 (min. A2 class) under PLS Scheme 2				
4.1	Fire-rated floor ⁽²⁾ (a) BS 476-21 or AS 1530-4 or ISO 834-5; and (b) Timber products: See section on cross/glued laminated timber	Scheme 5 (DoC issued)	Site inspection triggered by DoC (every 3500m ²) Annual surveillance test on material under Scheme 2	At least once annually	
5.	Fire-rated ceiling ⁽¹⁶⁾ Materials are listed under BS 476-4 or BS 476-11 or EN 13501-1 (min. A2 class) under PLS Scheme 2				
5.1	Compartmentation (a) BS 476-22 or EN 1364-2 or AS 1530-4 or ASTM E119 or ISO 834-9; and (b) Timber products: See section on cross/glued laminated timber	Scheme 5 (DoC issued)	Site inspection triggered by DoC (every 3500m ²) Annual surveillance test on material under Scheme 2	At least once annually	
5.2	Protection to steel beams that support RC floor ⁽²⁾ (a) BS 476-23, or (b) AS 1530-4, or (c) ISO 834-5	Scheme 5 (DoC Issued)	Site inspection triggered by DoC (every 3500m ²) Annual surveillance test on material under Scheme 2	At least once annually	
5.3	Protection to timber/ steel flooring ⁽²⁾ (a) BS 476-21, or (b) AS 1530-4, or (c) ISO 834-5	Scheme 5 (DoC issued)	Site inspection triggered by DoC (every 3500m ²) Annual surveillance test on material under Scheme 2	At least once annually	
6.	Fire-rated Enclosure/ spraying material ⁽¹⁶⁾ Materials are listed under BS 476-4 or BS 476-11 or EN 13501-1 (min. A2 class) under PLS Scheme 2				

TABLE 11A : LIST OF REGULATED FIRE SAFETY PRODUCTS & MATERIALS

S/N	Products / Materials	Acceptable Standards	Certification Scheme	Surveillance Regime	
				Testing	Factory/Site Inspection
6.1	Protection to steel structure ^{(2) (3)}	(a) BS 476-21 or AS 1530-4 or ISO 834-6 & ISO 834-7; and (b) BS 5234-2; and (c) EN 520 (gypsum plaster board); and (d) ISO 1896 (calcium silicate or cement board)	Scheme 5 (DoC issued)	Site inspection triggered by DoC (every 3500m ²) Annual surveillance test on material under Scheme 2	At least once annually
6.2	Protection to firefighting system i.e. sprinkler, rising mains, hydrant, etc. ⁽⁴⁾	(a) FSB/PSB/001, or (b) AS 1530-4 (Including Pipe insulation criteria on fire side, 500mm from wall, shall not exceed 75 deg. C)	Scheme 5 (DoC issued)	Site inspection triggered by DoC (every 3500m ²) Annual surveillance test on material under Scheme 2	At least once annually
6.3	Protection to building service i.e. cables, sanitary pipes, chilled water pipes, etc.	(a) BS 476-20, or (b) AS 1530-4, or (c) ASTM E119, or (d) ISO 834-1	Scheme 5 (DoC issued)	Site inspection triggered by DoC (every 3500m ²) Annual surveillance test on material under Scheme 2	At least once annually
7.	Smoke Curtain/Barrier ⁽¹⁶⁾ Materials are listed under EN 13501-1 (min. Class B) under PLS Scheme 2				
7.1	Smoke curtain/barrier	EN 12101-1	Scheme 1b (Labels issued)	Annual surveillance test on material under Scheme 2	Not Applicable
8.	Fire-rated duct system ⁽¹⁶⁾ Materials are listed under BS 476-4 or BS 476-11 or EN 13501-1 (min. A2 class) under PLS Scheme 2				

TABLE 11A : LIST OF REGULATED FIRE SAFETY PRODUCTS & MATERIALS

S/N	Products / Materials	Acceptable Standards	Certification Scheme	Surveillance Regime	
				Testing	Factory/Site Inspection
8.1	Fire-rated duct system, e.g. ventilation, smoke-extraction and/or kitchen exhaust ducting system ⁽⁶⁾	(a) BS 476-24, or (b) AS 1530-4, or (c) EN 1366-1, or (d) EN1366-8, or (e) EN 1366-9	Scheme 5 (DoC issued)	Site inspection triggered by DoC (every 3500m ²) Annual surveillance test on material under Scheme 2	At least once annually
9.	Fire extinguishing system for kitchen hood	UL 300	Scheme 5 (Labels issued)	Site inspection triggered by DoC (every 50 labels) or min. once per year	At least once annually
10.	Fire stopping material (including fire-rated collar)	<u>For penetration gaps and linear joints:</u> (a) BS 476-20, or (b) AS 1530-4, or (c) EN1366-3, or (d) EN 1366-4, or (e) ASTM E814. <u>For curtain wall application:</u> ASTM E2307	Scheme 5 (DoC issued)	At least once annual site surveillance, or Site inspection triggered by DoC (every 1000 openings/ metre run)	At least once annually
11.	Fire-rated glass block/glass partition/glass Panel ⁽⁷⁾	(a) BS 476-22 or EN 1364-1 or AS 1530-4 or ASTM E119 or ISO 834-8; and (b) BS 6206 or AS 2208 or EN 12600.	Scheme 5 (DoC issued)	Not Applicable for glass block Fire-rated glass partition - Impact test once every 3 years	At least once annually

TABLE 11A : LIST OF REGULATED FIRE SAFETY PRODUCTS & MATERIALS

S/N	Products / Materials	Acceptable Standards	Certification Scheme	Surveillance Regime	
				Testing	Factory/Site Inspection
12.	Exit sign (powered electrically)	1. IEC 60598-2-22; and 2. SS 563-1 or ISO 30061; and 3. SS 563-2.	Scheme 5, or Scheme 1b (Labels issued)	Scheme 5 – At least once annually or by trigger (every 2000 labels)	Scheme 5 – At least once annually or by trigger (every 2000 labels)
13.	Emergency lighting (self-contained)	(a) IEC 60598-2-22; and (b) SS 563-1 or ISO 30061; and (c) SS 563-2.	Scheme 5, or Scheme 1b (Labels issued)	Scheme 1b – Batch testing; Full tests over 3 years	Scheme 1b – Not Applicable
14.	Battery system (for exit signs and emergency lighting)	(a) SS 563-1 or ISO 30061; and (b) SS 563-2 or AS/NZS 2293-1.	Scheme 5, or Scheme 1b (Labels issued)	Scheme 5 – At least once annually or by trigger (every 2000 labels)	Scheme 5 – At least once annually or by trigger (every 2000 labels)
				Scheme 1b – Batch testing; Full tests over 3 years	Scheme 1b – Not Applicable
				Scheme 5 – At least once annually or by trigger (every 2000 labels)	Scheme 5 – At least once annually or by trigger (every 2000 labels)
				Scheme 1b – Batch testing; Full tests over 3 years	Scheme 1b – Not Applicable

TABLE 11A : LIST OF REGULATED FIRE SAFETY PRODUCTS & MATERIALS

S/N	Products / Materials	Acceptable Standards	Certification Scheme	Surveillance Regime	
				Testing	Factory/Site Inspection
15.	Self-luminous sign (powered by radioactive material)	(a) UL 924 and (b) SS 508-1 or ISO 3864-1; and (c) SS 508-2 or ISO 3864-2; and (d) SS 508-3 or ISO 3864-3; and (e) SS 508-5 or ISO 7010; and (f) SS 563-1 or ISO 30061 (Clause 10.5 of SS 563-1 shall be complied with for determination of the viewing distance with distance factor (Z) fixed at 50); and (g) For 'EXIT' sign : SS 563-2 (Clause C2)	Scheme 5, or Scheme 1b (Labels issued)	Scheme 5 - At least once annually or by trigger (every 2000 labels)	Scheme 5 - At least once annually or by trigger (every 2000 labels)
16.	Fire hose reel	EN 671-1	Scheme 5, or Scheme 1b (Labels issued)	Scheme 1b - Batch testing; Full tests over 3 years	Scheme 1b - Not Applicable
				Scheme 5 - At least once annually or by trigger (every 1500 labels). Full test over 5 years per type	Scheme 5 - At least once annually or by trigger (every 1500 labels)
				Scheme 1b - batch testing (full test)	Scheme 1b - Not Applicable

TABLE 11A : LIST OF REGULATED FIRE SAFETY PRODUCTS & MATERIALS

S/N	Products / Materials	Acceptable Standards	Certification Scheme	Surveillance Regime	
				Testing	Factory/Site Inspection
17.	Firefighting hose / Lay-flat fire hose	BS 6391	Scheme 5, or Scheme 1b (Labels issued)	Scheme 5 - At least once annually or by trigger (every 1000 labels); Full tests over 5 years per type	Scheme 5 - At least once annually or by trigger (every 1000 labels)
18.	Auditorium Seats ⁽⁶⁾	BS 5852, Clause 12 (Ignition source 0, 1 & 5)	Scheme 1b (Labels issued)	Scheme 1b - batch testing (full test)	Scheme 1b - Not Applicable
19.	Fire damper	<u>For fire test:</u> (a) SS 333 Clause 6.3, or (b) AS 1530-4 (The damper shall be tested with the damper at open position at the start of fire test and be able to completely close during the first 90 sec of the test.); or (c) ISO 834-8 & ISO 834-9 (The damper shall be tested with the damper at open position at the start of fire test and be able to completely close during the first 90 sec of the test.).	Scheme 1b (Labels issued)	Scheme 1b – At least once annually. Full test over 3 years: (a) Fire test; and (b) Air leakage test; and (c) Reliability test; and (d) Spring closing test (if applicable).	Not Applicable

TABLE 11A : LIST OF REGULATED FIRE SAFETY PRODUCTS & MATERIALS

S/N	Products / Materials	Acceptable Standards	Certification Scheme	Surveillance Regime	
				Testing	Factory/Site Inspection
	Fire damper (cont'd)	<p><u>For air-leakage test:</u></p> <ul style="list-style-type: none"> (a) SS 333 Clause 6.4, or (b) ISO 5167 and ISO 7244, or (c) EN 1751 Clause 5.2.1 to 5.2.4 <p>(Note: The requirements for sub-items 2, 3 & 4 shall be as specified in SS 333 Clause 6.4).</p> <p><u>For closing reliability test:</u></p> <ul style="list-style-type: none"> (a) SS 333 Clause 6.5, or (b) UL 555 Clause 11.2. <p><u>For spring closing force test:</u></p> <ul style="list-style-type: none"> (a) SS 333 Clause 6.6, or (b) UL 555 Clause 13. 			
20.	Fire-rated door ⁽¹⁴⁾	<ul style="list-style-type: none"> (a) SS 332 Clause 4 or EN 1634-1; and (b) For fire-rated glass door Impact test: BS 6206 or AS 2208 or EN 12600. 	<p>Scheme 5, or</p> <p>Scheme 1b (Labels issued)</p>	<p>Fire test:</p> <p>Timber/Composite door - At least once annually</p> <p>Steel/Glass door – Once every 3 years</p> <p>Impact test for fire-rated glass door – Once every 3 years</p>	<p>Scheme 5 -</p> <p>At least once annually or by trigger (every 500 labels) - Factory or site</p> <p>Scheme 1b - Not Applicable</p>

TABLE 11A : LIST OF REGULATED FIRE SAFETY PRODUCTS & MATERIALS

S/N	Products / Materials	Acceptable Standards	Certification Scheme	Surveillance Regime	
				Testing	Factory/Site Inspection
21.	Bin/linen chute door	(a) BS 476-22, or (b) EN 1634-1, or (c) AS 1530-4.	Scheme 5, or Scheme 1b (Labels issued)	Fire test once every 3 years	Scheme 5 - At least once annually or by trigger (every 500 labels) Scheme 1b - Not Applicable
22.	Fire-rated lift landing/ dumb waiter door	(a) For lift-landing door: BS 476-22 or EN 81-58; and (b) For fire-rated glass door (Impact test): BS 6206 or AS 2208 or EN 12600.	Scheme 1b (Labels issued)	Fire test - once every 3 years Impact test - once every 3 years	Not Applicable
23.	Fire-rated shutter/fire- rated curtain	(a) SS 489 Clauses 5 & 4.5.1 or (b) EN 1634-1 (The fire-rated shutter/fire- rated curtain shall close at between 10 sec and 30 sec.).	Scheme 1b (Labels issued)	Batch inspection - No surveil- lance. Fire test once every 3 years	Not Applicable
24.	Fire-rated / hatch door	(a) BS 476-22, or (b) EN 1634-1, or (c) AS 1530-4.	Scheme 5, or Scheme 1b (Labels issued)	Fire test once every 3 years	Scheme 5 - At least once annually or by trigger (every 500 labels) Scheme 1b - Not Applicable

TABLE 11A : LIST OF REGULATED FIRE SAFETY PRODUCTS & MATERIALS

S/N	Products / Materials	Acceptable Standards	Certification Scheme	Surveillance Regime	
				Testing	Factory/Site Inspection
25.	Portable fire extinguisher ⁽⁵⁾	(a) SS EN 3-7; and (b) EN 3-8; and (c) EN 3-9. (Where applicable)	Scheme 5, or Scheme 1b (Labels issued).	Scheme 5 – At least once annually or by trigger (every 5000 labels). Full tests over 5 years per type	Scheme 5 - At least once annually or by trigger (every 5000 labels)
26.	Fire-rated cables	(a) SS 299-1, or (b) BS 6387 and BS 7846 (Clauses 16.2 and 16.3).	Scheme 5 (Certified mark printed on cables)	Scheme 1b - Batch testing Full tests over 3 years	Scheme 1b - Not Applicable At least once annually
27.	Intumescent coating system (for protection to steel structure) ⁽⁹⁾	(a) EN 16623 (for fire resistance test and durability test), or (b) ISO 834-6 or ISO 834-7 (fire resistance test); and EN 16623 (durability test), or (c) BS 476-21 or AS1530-4 (load-bearing fire resistance test); and BS 8202-2 (durability tests).	Scheme 5 (DOC issued)	Full durability/fire test over 3 years.	At least once annually

TABLE 11A : LIST OF REGULATED FIRE SAFETY PRODUCTS & MATERIALS

S/N	Products / Materials	Acceptable Standards	Certification Scheme	Surveillance Regime	
				Testing	Factory/Site Inspection
28.	Landing valve	BS 5041-1	Scheme 5, or Scheme 1b (Labels issued)	Scheme 5 – At least once annually or by trigger (every 1500 labels); Full tests over 5 years per type Scheme 1b - Batch testing	Scheme 5 – At least once annually or by trigger (every 1500 labels) Scheme 1b - Not Applicable
29.	Breeching inlet	BS 5041-3	Scheme 5, or Scheme 1b (Labels issued)	Scheme 5 – At least once annually or by trigger (every 1000 labels); Full tests over 5 years per type Scheme 1b - Batch testing	Scheme 5 – At least once annually or by trigger (every 1000 labels) Scheme 1b - Not Applicable
30.	Raised floor panel ⁽¹⁰⁾⁽¹⁶⁾	(a) BS 476-4, or (b) BS 476-11, or (c) EN 13501-1 (min. Class A2 - applicable to the core material of composite con- struction).	Scheme 2 (No label issued)	Annual surveillance test	Not Applicable

TABLE 11A : LIST OF REGULATED FIRE SAFETY PRODUCTS & MATERIALS

S/N	Products / Materials	Acceptable Standards	Certification Scheme	Surveillance Regime	
				Testing	Factory/Site Inspection
31.	Material for wall/ceiling/floor construction ⁽¹⁶⁾	(a) BS 476-4, or (b) BS 476-11, or (c) BS 476-7, or (d) BS 476-6 & BS 476-7, or (e) EN 13501-1. For plastic wall/ceiling/floor construction, refer to Cl.3.15.19 for the testing requirements.	Scheme 2 (No label issued)	Annual surveillance test	Not Applicable
32.	Thermal insulation material ⁽¹⁰⁾ ⁽¹⁶⁾	(a) BS 476-4, or (b) BS 476-11, or (c) BS 476-7, or (d) BS 476-6 & BS 476-7, or (e) EN 13501-1 and 2. For plastic wall/ceiling/floor construction, refer to Cl.3.15.19 for the testing requirements.	Scheme 2 (No label issued)	Annual surveillance test	Not Applicable

TABLE 11A : LIST OF REGULATED FIRE SAFETY PRODUCTS & MATERIALS

S/N	Products / Materials	Acceptable Standards	Certification Scheme	Surveillance Regime	
				Testing	Factory/Site Inspection
33.	Finishing material for wall/ceiling ⁽¹⁶⁾	(a) BS 476-4, or (b) BS 476-11, or (c) BS 476-7, or (d) BS 476-6 & BS 476-7, or (e) EN 13501-1 & 2. For plastic wall/ceiling finishes, refer to Cl.3.15.19 for the testing requirements.	Scheme 2 (No label issued)	Annual surveillance test	Not Applicable
34.	Roof covering material ⁽¹⁵⁾ ⁽¹⁶⁾	(a) BS 476-4, or (b) BS 476-11, or (c) BS 476-7, or (d) BS 476-6 & BS 476-7, or (e) EN 13501-1 or (f) ASTM E108. For plastic roof covering, refer to Cl.3.15.19 for the testing requirements.	Scheme 2 (No label issued)	Annual surveillance test	Not Applicable

TABLE 11A : LIST OF REGULATED FIRE SAFETY PRODUCTS & MATERIALS

S/N	Products / Materials	Acceptable Standards	Certification Scheme	Surveillance Regime	
				Testing	Factory/Site Inspection
35.	Composite panel (cladding to external wall) ⁽¹²⁾ ⁽¹⁶⁾ (Composite panel shall be tested on its core material or as an assembly.)	For test on the core material of composite panel: (a) BS 476-4, or (b) BS 476-11, or (c) BS 476-6 & BS 476-7, or (d) EN 13501-1, or	Scheme 2 (No label issued)	Annual surveillance test	Not Applicable
		For test on the composite panel assembly: NFPA 285		Annual surveillance test (finger printing)	
36.	UPVC window frame material ⁽¹³⁾	ASTM D635	Scheme 2 (No label issued)	Annual surveillance test	Not Applicable
37.	Door closer/other hardware ⁽¹⁴⁾	(a) SS 332: Clause 5, or (b) EN 179 or EN 1125 or EN 1154 or EN1155 or EN 1158 or EN 1303 or EN 1527 or EN 1906 or EN 1935 or EN 12051 or EN 12209 (wherever applicable if installed on the fire door).	Scheme 5 (Mark printed on hardware)	Annual surveillance test	At least once annually

TABLE 11A : LIST OF REGULATED FIRE SAFETY PRODUCTS & MATERIALS

S/N	Products / Materials	Acceptable Standards	Certification Scheme	Surveillance Regime	
				Testing	Factory/Site Inspection
38.	Household shelter door	Refer to SCDF's circulars on the: (a) Technical Requirements of Household Shelters 2001 & Product Listing Scheme for Household Shelter (HS) Door dated 28 Feb 2002; and (b) Product Listing Scheme (PLS) for Household Shelter (HS) Doors – Revision in Rubber Gasket Specification dated 17 Mar 2004; and (c) Product Listing Scheme for Household Shelter Doors – Revision in Cathode Electro-Deposition (CED) Coating Test Specification dated 8 Feb 2006.	Scheme 5 (Labels issued)	Once every 3 years for cyclic test. Annually for water tightness test, dimension check, CED coating test & rubber gasket test	At least once annually or by trigger (every 200 labels)
39.	Storey shelter door	Refer to SCDF's circular on the Product Listing Scheme (PLS) for Storey Shelter (SS) Door dated 8 Feb 2006	Scheme 5 (Labels issued)	Once every 3 years for cyclic test. Annually for water tightness test, dimension check, CED coating test & rubber gasket test	At least once annually or by trigger (every 200 labels)
40.	Cross/glued laminated timber	(a) EN 1363-1; and (b) EN 1364-1 or EN 1365-1.	Scheme 5 (DoC issued)	Site inspection triggered by DoC (every 3500m ²). Annual surveillance test on material under Scheme 2	At least once annually

TABLE 11A : LIST OF REGULATED FIRE SAFETY PRODUCTS & MATERIALS

S/N	Products / Materials	Acceptable Standards	Certification Scheme	Surveillance Regime	
				Testing	Factory/Site Inspection
41.	Finishing material for floor	For plastic floor finishes, refer to Cl.3.15.19 of for the testing requirements.	Scheme 2 (No label issued)	Annual surveillance test	Not Applicable
42.	Solar Photo-voltaic (PV) roof-mounted module	Materials are listed under IEC 61730-2 with a min. fire performance rating of Class C under PLS Scheme 2			
42.1	Solar Photo-voltaic (PV) roof-mounted module	IEC 61730-2 (for fire test only)	Scheme 2 (No label issued)	Biennial surveillance fire test	Not Applicable
43.	Coldroom material	For non-fire-rated coldroom material: (a) Flame spread test: EN 13501-1; and (b) Toxicity emission test: EN 45545-2; and (c) Smoke density test : EN 13501-1.	Scheme 5 (DoC issued)	Annual surveillance test on material Site inspection triggered by DoC (every 3500m ²)	At least once annually
		For fire-rated coldroom material: (a) Fire resistance test : BS 476-22 or EN 1364-1 or AS 1530-4 or ASTM E119 or ISO 834-8; and (a) Flame spread test: EN 13501-1; and (b) Toxicity emission test: EN 45545-2; and (c) Smoke density test: EN 13501-1.	Scheme 5 (DoC issued)	Annual surveillance test on material Site inspection triggered by DoC (every 3500m ²)	At least once annually

TABLE 11A : LIST OF REGULATED FIRE SAFETY PRODUCTS & MATERIALS

S/N	Products / Materials	Acceptable Standards	Certification Scheme	Surveillance Regime		
				Testing	Factory/Site Inspection	
<p>Note:</p> <p>(1) = “DoC” stands for “Declaration of Compliance”.</p> <p>(2) = ASTM E119 are not acceptable for load-bearing elements.</p> <p>(3) = <i>Cl.3.3.6</i> shall be complied with.</p> <p>(4) = The insulation criterion shall be at least 30 minutes.</p> <p>(5) = SS EN 3-7 is not a full adoption of EN 3-7. The modifications are described in the National Forward of SS EN 3-7.</p> <p>(6) = Insulation criteria of ducting system shall have both internal and external rating.</p> <p>(7) = Use permitted in sprinkler protected buildings only.</p> <p>(8) = Requirements apply to upholstered seats and plastic seats, either in fixed position or retractable type.</p> <p>(9) = For BS 8202 the external system durability test shall include: a) Humidity test, b) washing test, c) Sulphur dioxide test, d) salt spray test, e) heat exposure test, f) natural exposure test, g) control specimen. The internal system durability test shall include: a) Sulphur dioxide test, b) natural exposure test, c) heat exposure test, d) washing test, e) humidity test, f) control specimen. For EN 16623 the durability test shall include type ‘X’ intended for all conditions and type ‘Y’ intended for internal and semi-exposed conditions.</p> <p>(10) = Materials containing plastics shall not be allowed.</p> <p>(11) = Local CoC not required unless full testing done locally. For more information, refer to <i>Cl.6.3.6</i>.</p> <p>(12) = External wall shall have fire-resistance test rating not less than 1 hour.</p> <p>(13) = Installation of UPVC window frame shall conform to <i>Cl.3.15.20</i>.</p> <p>(14) = Door closers used in fire-rated door are separately listed under PLS Class Scheme 5.</p> <p>(15) = Insulating lining shall achieve Class 1 flame spread rating.</p> <p>(16) = Fire classification of construction products & building elements between Euro class & UK class:</p>						
				Euro Class (EN 13501-1)	UK Class (BS Standard)	Remarks
				A1	Non-Combustible (BS 476 Pt 4)	
				A2 (or better)	Limited Combustibility (BS 476 Pt 11)	
				B (or better)	Class 0 (BS 476-6 & BS 476 Pt 7)	
				C (or better)	Class 1 & 2 (BS 476 Pt 7)	
				D (or better)	Class 3 (BS 476 Pt 7)	
				E (or better)	Class 3 (BS 476 Pt 7)	
				F (or better)	Class 4 (BS 476 Pt 7)	
						Meeting an EN standard implies that the corresponding BS standard is complied with but not vice-versa.

ANNEX 11A
ADMINISTRATIVE REQUIREMENTS

A1.0 ACCREDITATION REQUIREMENTS

- a. All CBs offering services in Singapore to certify regulated fire safety products and materials shall be accredited by Singapore Accreditation Council (SAC), and shall comply with the requirements stipulated in ISO/IEC 17065 (Conformity Assessment - Requirements for Bodies Certifying Products, Processes and Services).
- b. All testing laboratories offering services to test regulated fire safety products/ materials shall be accredited by SAC or recognised by SAC via the MRA, and shall comply with the requirements stipulated in ISO/IEC 17025 (General Requirements for the Competence of Testing and Calibration Laboratories).
- c. All overseas CBs shall have their local offices and representatives in Singapore to follow up on queries/complaints and monitor the products & materials certified by them.
- d. CBs participating in the Product Listing Scheme (PLS) shall inform SCDF officially of its intention and submit to SCDF its Certificate of Accreditation and Schedule issued by SAC for record. In addition, SCDF may request for additional information or impose other requirements on the CBs.

A2.0 CERTIFICATION REQUIREMENTS

The list of regulated fire safety products & materials and required surveillance regime are given in [Table 11A](#) of the Fire Code. Certification of these regulated fire safety products shall comply with the requirements stipulated in ISO/IEC 17067 (Conformity Assessment - Fundamentals of Product Certification and Guidelines for Product Certification Schemes) and shall be based on the following certification schemes specified under *Cl. 11.2*.

A3.0 PROVISION OF MINIMUM INFORMATION BY CBS ON CERTIFIED FIRE SAFETY PRODUCTS & MATERIALS AND PRODUCTS & MATERIALS WHICH FAILED THE CERTIFICATION REQUIREMENTS

CBs shall provide the minimum information as specified below in their directory for certified fire safety products and materials and products & materials which failed the certification requirements for verification by the public. Such information shall be part of the audit requirements of SAC.

- a. **Certified fire safety products and material under the PLS**
 - (1) Applicant (includes company's name, address, contact nos)
 - (2) Brand
 - (3) Model

- (4) Certificate No
- (5) Scheme of CoC
- (6) CoC Expiry Date
- (7) Description
- (8) Country of Origin
- (9) Product Details (includes insulation, integrity, density/weight, etc.)
- (10) Test Standard
- (11) Test Report Reference

b. Products & materials which failed the certification requirements

- (1) Applicant (includes company's name, address, contact nos)
- (2) Brand
- (3) Model
- (4) Description
- (5) Country of Origin
- (6) Product Details (includes insulation, integrity, density/weight, etc.)
- (7) Test Standard

A4.0 APPLICANTS OF FIRE SAFETY PRODUCTS & MATERIALS SEEKING MULTIPLE CERTIFICATIONS FROM CBS

- a. An applicant who seeks certification of their fire safety products with a CB shall declare the status of certification he had with the previous CB.
- b. If the applicant had previously sought certification with a CB but failed in its certification attempt, he is required to submit the latest audit report and surveillance test results prepared by the previous CB to the new CB for their reference and highlight any improvement made to the product to be certified by the new CB.
- c. However, if the applicant declares that he has yet to seek certification with any CB, it shall be mandatory for the CB that is approached by the applicant to confirm the status from the directory of certified and failed products maintained by the other CBs.
- d. If the CB subsequently finds out that the applicant had earlier approached a CB but failed in its certification attempt, the CB shall require the applicant to:
 - (1) submit the latest audit report and surveillance test results prepared by the previous CB; and

- (2) highlight any improvement made to the product. If the applicant fails to do so, the CB shall reject the applicant's application for certification of the product.
- e. Compliance with the procedures by the CBs shall be part of the audit requirements of SAC.

A5.0 MANAGEMENT OF FIRE SAFETY PRODUCT LABELS

- a. CBs who issue the fire safety product labels shall maintain a record for periodic audit. The records shall be maintained for 10 years. CBs shall provide all records to SCDF upon request within a given prescribed timeline.
- b. Fire safety product labels are controlled and serialized items. Such records shall form part of the audit requirements of SAC to ensure its transparency and accountability.
- c. The supplier of a regulated fire safety product shall make a police report on the missing product labels before they are replaced with new labels by the CBs. CBs are also required to conduct an investigation on the root cause of the missing product labels, and to submit a report to SCDF.

A6.0 TRACEABILITY OF CERTIFIED PLS LISTED PRODUCTS

- a. Regulated fire safety products listed under the PLS and certified under Scheme Type 5 (Scheme 5) (Discrete System) and Scheme Type 1b (Scheme 1b) are issued with product labels which are displayed on the products. To enhance accountability, speedy audit process and traceability of regulated fire safety product, the supplier who is the certificate holder of CoCs of these categories of regulated products shall also display labels which include their company's name on the certified fire safety products.
- b. Both the product labels and company labels displayed on the certified fire safety products shall be water-proof, tampered-proof and capable of preventing forgery of labels.
- c. The product labels shall indicate the product category, unique label identification number and CB logo.

FIRE CODE
2018

APPENDICES

APPENDIX

01

FIRE SAFETY REPORT

1.0 GENERAL

- a. Fire safety report is to document the provision of fire protection, life safety features and fire safety management in the building and/or plants/installations. This report serves as a useful reference to Fire Safety Managers (FSMs), building owners, Registered Inspectors (RIs), the SCDF and Qualified Persons (QPs) appointed to carry out any subsequent additions and alteration works. Where the nature of the additions and alteration works would require the updating of the fire safety report, the QP shall be responsible to submit revised and updated report to the building owner/s and the SCDF.
- b. The project QP shall submit a report on fire protection, life safety features and fire safety management when making building plan submission for projects such as:
 - (1) Commercial buildings exceeding 60m in habitable height.
 - (2) Commercial buildings with Accessible Floor Area (AFA) greater than 5000m² or having a total occupant load exceeding 1000 persons (car park floor areas can be excluded in the computation of AFA and occupant load).
 - (3) Industrial buildings with AFA floor area exceeding 5000m².
 - (4) Petroleum/chemical plants and installations.
 - (5) Buildings exceeding 24m in habitable height where fire-rated drywalls are used for the construction of protected shafts for staircases and/or lifts.
 - (6) Buildings exceeding one storey using fire-rated board protection or intumescent paints for structural steel.
 - (7) Super high-rise residential buildings of more than 40 storeys/levels.
 - (8) Buildings with structural steel members coated with intumescent paint (for buildings of habitable height below 24m, only item a., b., d., e. & r. of [para.2.0](#) need to be included in the fire safety report).
 - (9) Mega underground developments.
- c. In buildings under PG VI & VIII, where there may be presence of corrosive atmosphere that may affect the effectiveness of intumescent paints for protection to structural steel members of buildings and fire-rated dry board, such proposal shall be subjected to evaluation of the SCDF.

2.0 CONTENTS OF THE REPORT

The write-up of the report on fire protection and life safety features shall include the following subjects. However, qualified person could expand or modify the report to suit his presentation:

- a. project description;
- b. fire safety design concept;
- c. fire engine accessibility;
- d. means of escape;
- e. structural fire precautions;
- f. control and exhaust of smoke and toxic fumes;
- g. firefighting systems;
- h. h. fire alarm system;
- i. emergency power supply;
- j. emergency evacuation lighting;
- k. emergency voice communication system;
- l. two-way emergency voice communication system;
- m. emergency lift control;
- n. areas of fire risk;
- o. fire scenario;
- p. fire safety management;
- q. conclusion; and
- r. attachments.

3.0 BRIEF EXPLANATORY NOTES FOR OUTLINE REPORT ON FIRE PROTECTION AND LIFE SAFETY FEATURES

a. Project description

A description of the project with brief outline of the facilities provided. For industrial and petroleum/chemical plants and installations, details of the following are to be provided:

- (1) a diagrammatic process flow chart with a brief description of the process/ activities that will be carried out;
- (2) the raw materials to be used;

- (3) the nature of the products; and
- (4) all hazardous chemicals, flammable liquids, solvents, etc. that will be handled/stored.

b. Fire safety design concept

This would include the safety design concept incorporated in the project such as the application of design and provision of areas of refuge, smoke barriers, additional compartment walls/ doors in sectionalizing the large atrium floors etc. and other added fire safety features provided over and above the intent of the Code.

c. Fire engine accessibility

This would briefly outline the driveways, which are paved to withstand the load of fire engines, to be provided.

d. Means of escape

This would include the description of the escape routes that would be taken by occupants in the building in a fire scenario, besides the provision of the number, type and location of staircases, etc..

e. Structural fire precautions

This would outline the fire resistance rating and the type of structural protection to elements of structures, compartment walls/floors, types and methods of fire-stoppings to ducts, cavity and curtain walling construction, and types and rating of all fire doors.

f. Control and exhaust of smoke and toxic fumes

This would include the description of the type of system to be provided to car parks, atrium, staircases and lobbies, air-conditioning units, etc..

g. Firefighting system

This would include the active protection system such as portable fire extinguishers, hose reels, dry/wet rising mains, sprinkler system, gas flooding system, fixed/portable water monitors, fixed water spray, drenchers, etc..

h. Fire alarm system

This would include the provision of passive fire protection system such as automatic fire detection systems (smoke or heat type), 'break the glass' fire alarm system. Besides naming the type of automatic system, the description should also include where the detectors would be generally located in fire risk areas/rooms such as lift motor rooms, electrical switch rooms, MDF, IDF and PABX rooms electrical ducts and enclosed elevator shafts, and how, when any of the systems is activated, the public, the people in the Fire Control Room and the nearest fire station or approved fire alarm monitoring company are alerted.

i. Emergency power supply

This would include the description of how the emergency power system

operates in times of loss of normal electric power supply to any part of the building and the areas or systems that will be designed to receive emergency power.

j. Emergency evacuation lighting

This would include the description of the system designed in accordance with SS 563, and the location of exit signs etc. and the types of battery system, and designed time for the switchover to emergency lighting system from the time the normal power supply is cut-off.

k. Emergency voice communication system

This would involve the description of the provision of the one-way zoned and electrically monitored emergency paging system to critical areas such as lobbies, corridors, exit stairways, toilets, restaurant, shop and offices, M&E plant rooms. The emergency public address system which generally complies with SS 546 would include communication between FCC and all parts of the building through electrical loudspeakers.

l. Two-way emergency voice communication system

This would describe the operation of the 2-way zoned and coded voice communication system, which is electrically supervised from the central control located in the FCC including the provision of slave telephones to critical areas such as:

- (1) every fire lift lobby including 1st storey;
- (2) all firefighting related mechanical equipment rooms inclusive of sprinkler pump room, wet rising main pump room, hose reel pump room, etc.;
- (3) all rooms housing smoke control equipment;
- (4) all lift machine rooms;
- (5) any other locations as may be required by the SCDF.

m. Emergency lift control

This would describe the function of the Emergency Lift Control conforming to the requirements under SS 550. The description of the emergency lift control would also include the sequence of events in case of:

- (1) power failure;
- (2) fire emergency; and
- (3) both power failure and fire emergency.

n. Areas of fire risk

This would briefly describe the areas of fire risk such as AC plant room, generator room, oil tank room, etc. and the type of fire protection/detection system proposed.

o. Fire scenario

Under this subject, the qualified person would have to assume the outbreak of a fire in one of the critical floors or areas and describe the sequence of operation of the fire protection and life safety design features.

p. Fire safety management

(1) This would include a brief description of the general management of the fire protection and life safety features of the building as prescribed in the Fire Safety (Building and Pipeline Fire Safety) Regulations. For building, defined as super high-rise private residential building, this would also include describing the role of the competent person appointed by the building owner or MCST in undertaking the following responsibilities:

- (a) co-ordinating and supervise the evacuation of residents;
- (b) train staff to ensure effective emergency response actions in the event of fire;
- (c) formulate the fire evacuation procedures;
- (d) supervise the maintenance of fire safety works in the premises;
- (e) conduct daily fire safety checks;
- (f) remove fire hazards in the common areas of the premises;
- (g) prepare fire safety circulars or guidebooks for residents; and
- (h) maintain good fire safety standard within the premises.

(2) Private residential building refers to a building or part of a building that is used or intended to be used for residential purposes but does not include public housing.

q. Conclusion

This would include the summing up of the outline concepts and systems that have been designed for the project.

r. Attachments

- (1) Location plans of steel structural members coated with intumescent paint.
- (2) Location plans of fire risk areas.
- (3) Any other attachments required for the report.

APPENDIX**02****FIRE SAFETY INSTRUCTION MANUAL****1.0 GENERAL**

- a. The fire safety instruction manual is a document prepared by the project QP to remind the building owner, MCST, tenant, operator and/or contractor on the management of fire safety provisions for the building. This includes maintenance regimes, evacuation procedures, and other relevant documents to be kept and maintained by the relevant parties. Any subsequent additions and alteration works shall be updated in the fire safety instruction manual by the QP carrying out the A/A works.
- b. The fire safety instruction manual, including any subsequent updates, shall be submitted by the project QP to the SCDF for record when making building plan submission. A copy of which shall be handed officially to the relevant parties for information and safe keeping before occupation of the building.
- c. The QP can expand or modify the fire safety instruction manual to suit his presentation so as to convey the fire safety intents/requirements to the relevant parties.

2.0 SCOPE

The QP shall prepare a fire safety instruction manual if the project involves any of the following:

- a. Fire safety provisions for PWDs
- b. Chemical/HazMat warehouse
- c. Fully Automated Mechanised Car Park (FAMCP)
- d. Buildings using intumescent paint
- e. Super high-rise residential buildings
- f. Liquefied Petroleum Gas (LPG) cylinder installation
- g. Mega underground developments
- h. Use of lifts in buildings for evacuation
- i. Engineered timber building construction
- j. Hoarding & safety nets
- k. Temporary workers' quarters in uncompleted permanent buildings on construction sites

- l. Ductless jet fans system in car parks
- m. Kitchen exhaust ducts
- n. Fire-rated dry construction

3.0 CONTENTS OF THE MANUAL

The fire safety instruction manual shall include the following subjects:

- a. project description;
- b. list of items under paragraph 2 present in this project; and
- c. relevant information for each applicable item.

4.0 RELEVANT INFORMATION TO BE INCLUDED IN THE FIRE SAFETY INSTRUCTION MANUAL

4.1 Fire safety provisions for PWDs

a. **Planning of evacuation for PWDs**

The building owner/MCST shall plan the evacuation procedures for PWDs. Planning includes identifying the needs of PWDs and making arrangements for assistance during emergency. The building owner/MCST shall keep the following information:

- (1) locations plan of PWD Holding Point and PWD evacuation lift;
 - (2) the number of PWDs;
 - (3) the location of the PWDs; and
 - (4) the nature of their disabilities.
- b. The evacuation procedures shall be tested at least once a year and involve both horizontal, if provided, and vertical evacuation.
- c. The building owner/MCST shall ensure that the staff, designated to help PWDs in the event of fire, are fully trained to execute the following evacuation procedure:
- (1) **Building with evacuation lift**
 - (a) PWDs requiring assistance shall move or be directed to the PWD Holding Point in the evacuation lift lobby.
 - (b) The trained staff shall attend to PWDs from PWD Holding Point and direct them to the final exit.

(2) Building without evacuation lift

- (a) On hearing the alarm, PWDs requiring assistance shall be moved or be directed to the nearest PWD Holding Point inside the exit staircase.
- (b) The trained staff, after completing their search, shall proceed to the PWD Holding Point and assist the PWDs down the exit staircase to the final exit.

4.2 Chemical/HazMat warehouse

- a. The laboratory operators shall minimise the amount of flammable liquids on benches by returning them to chemical store or safety cabinets when the liquids are not needed for the day.
- b. The laboratory operators shall ensure that the quantity of these liquids placed on benches and fume cupboards shall not exceed 10% of the total allowable storage capacity within the laboratory unit.
- c. Liquids used for running and operating laboratory instruments or other work-in-progress which may require some quantities of solvents to operate are exempted from the 10% limit.

4.3 Fully Automated Mechanised Car Park (FAMCP)

- a. The building owner/MCST of Category 2 & 3 FAMCPs shall provide self-contained breathing apparatus and maintained in a clearly marked cabinet for maintenance personnel.
- b. Maintenance personnel shall be equipped with the breathing apparatus while working in FAMCPs.
- c. Signage with words of minimum 50mm in height shall be clearly visible and state: "Personnel must be equipped with the breathing apparatus during maintenance".

4.4 Buildings using intumescent paint**a. Inspection and maintenance**

- (1) The building owner/MCST, shall carry out annual inspection checks to ensure that the intumescent paint coatings are not damaged or tampered with. Records of inspection shall be properly kept.
- (2) For buildings with Fire Certification, the annual renewal of the certificate shall include the inspection of the columns and beams coated with intumescent paint. The inspection shall be carried out by a QP.

b. Addition/alteration works

For addition/alteration works in a building where structural steel members are protected by intumescent paint, the following requirements shall be complied

with:

- (1) The building owner/MCST/tenant, assisted by the FSM, shall engage a QP who shall submit building plans to the SCDF. The building plans shall be accompanied by the QP's declaration as to whether the existing columns, beams coated with intumescent paint are/will be affected.
 - (2) Inspection certificate endorsed by a RI shall be required and kept by the building owner/MCST.
 - (3) The fire safety report shall be updated accordingly.
- c. There shall be no highly flammable/combustible materials stored within the vicinity of any structural steel members protected by intumescent paint.

4.5 Super high-rise residential buildings

- a. The building owner/MCST shall appoint a competent person prior to the occupation of the building.
- b. The competent person shall be trained in the formulation of fire evacuation procedures, basic firefighting, and the conduct of daily fire safety checks and all other duties stipulated in the fire safety report.

4.6 Liquefied Petroleum Gas (LPG) cylinder installation

- a. The building owner/MCST/tenant shall observe the Regulation 53 of the Fire Safety (Petroleum and Flammable Materials) Regulations 2005 and the conditions stipulated under Cl.10.1 of the Fire Code for the storage/use of 15kg LPG cylinders within building.
- b. The owner/tenant of eating outlet or food stall together with the gas supplier/dealer are responsible to ensure that the automatically shut-off system is well maintained and that the gas leak detection system is checked and calibrated periodically basing on the recommendation by a competent person.
- c. The Fire Certificate inspection programme for the building shall include the "automatic detection and shut-off system".

4.7 Mega underground developments

- a. The building owner/MCST shall form a Company Emergency Response Team (CERT) for his underground development.
- b. **Training and other safety requirements in caverns**
 - (1) All working occupants in the underground development are required to be properly and thoroughly briefed on the fire emergency plans.
 - (2) All working occupants shall be trained on basic firefighting and rescue matters. Safety hoods shall be equipped and provided for each working occupant in the caverns.

4.8 Use of lifts in buildings for evacuation

- a. The building owner/MCST shall designate his staff to supervise the evacuation during a fire emergency.
- b. Evacuation using fire lifts or evacuation lifts shall only be carried out under the supervision of firefighters/CERT.
- c. Upon the arrival of SCDF at the fire scene, the designated staff supervising the evacuation shall brief the fire officer in-charge on the position and circumstances of the fire and the progress of the evacuation. SCDF will then take over the supervision of the evacuation.

4.9 Engineered timber building construction

Where automatic fire detection/suppression systems are installed, the engineered timber building owner/MCST shall undertake to engage a QP to conduct annual inspection of these systems and to submit inspection reports to SCDF.

4.10 Hoarding & safety nets

- a. The building owner/MCST shall ensure a copy of QP-endorsed hoarding plans is kept at the FCC, security guard room or information counter in the order of priority at all times. Such requirement is optional if the hoardings does not affect the following areas/facilities:
 - (1) fire hydrants;
 - (2) fire engine accessway/fire engine access road;
 - (3) fire lift;
 - (4) exit staircase; and
 - (5) dry/wet riser.
- b. The building owner/MCST is required to notify all the tenants/occupants of the locations of alternate means of escape 2 weeks prior to carrying out the hoarding and renovation works.
- c. The building owner/MCST is required to inform the nearest SCDF fire station of any hoarding works that affect the above-mentioned areas/facilities.
- d. The affected firefighting facilities/areas shall be clearly shown on the plans and submitted to the relevant fire station. The alternative or nearest firefighting facilities that can be accessed by the fire station responding personnel shall be highlighted on the plan.

4.11 Temporary workers' quarters in uncompleted permanent buildings on construction sites

The main contractor shall ensure that:

- a. all temporary workers' quarters within the construction site are maintained in good conditions and they shall not be allowed to deteriorate into a slum-like condition through unauthorised extensions and overcrowding;
- b. unwanted articles are not stored in and around the temporary workers' quarters; and
- c. all exits, escape routes and passageway are kept free of obstruction at all times.

4.12 Ductless jet fans system in car parks

- a. The building owner/MCST shall keep a copy of the operations and maintenance manual as a guide for future renovations and changes to the building.
- b. The manual prepared by the QP shall contain the roles and responsibilities of the building owner/MCST, the restriction placed on the building identification of the sub-systems, servicing and maintenance plan, fault identification, etc..

4.13 Kitchen exhaust ducts

The building owner/MCST/tenant/operator shall ensure that the entire kitchen exhaust system, including those within individual restaurant/F&B outlet shall be properly maintained. The entire (interior and exterior) exhaust duct and kitchen hood shall be degreased and cleaned at least once every 12 months. The work shall be carried out by a specialist and the records of cleaning and degreasing shall be kept by the relevant parties for verification by the authorities having jurisdiction and the SCDF.

4.14 Fire-rated dry construction

The building owner/MCST shall engage a QP for any subsequent A&A works involving new or existing fire-rated dry construction.

APPENDIX

03

CLAUSE HISTORY

Fire Code 2018 Clause No.	Fire Code 2013 Clause No.	Clause Status	Effective Date
CHAPTER 1			
1.1	1.1	---	
1.1.1	1.1.2	Renumbered	
1.1.2	1.1.16	Renumbered	
1.1.3	---	New	01.03.2019
1.1.4	Chapter 9 and Appendices	Relocated.	
1.2	---	New	01.03.2019
1.2.1	---	New	01.03.2019
1.2.2	---	New	01.03.2019
1.3	1.2.1	Renumbered	
1.4	1.2	Renumbered	
1.4.1	---	New	01.03.2019
1.4.2	1.2.1(A)	Renumbered, rephrased	
1.4.3	2.5.1(e)	Renumbered	
1.4.4	1.2.2(A)	Renumbered	
1.4.5	1.2.2(B)	Renumbered, rephrased	
1.4.6	Appendix 12 (5)	Relocated	
1.4.7	1.2.2	Renumbered	
1.4.8	1.2.3(b)	Renumbered	
1.4.9	1.2.4	Renumbered, rephrased	
1.4.10	1.2.3(c)	Renumbered, rephrased	
1.4.11	1.2.3(a)	Renumbered, rephrased	
1.4.12	2.8.1	Renumbered	
1.4.13	1.2.5	Renumbered	
1.4.14	---	New	01.03.2019
1.4.15	1.2.6	Renumbered, rephrased	
1.4.16	Appendix 12 (2)	Relocated	
1.4.17	1.2.7	Renumbered	
1.4.18	1.2.8	Renumbered, rephrased	
1.4.19	1.2.9	Renumbered	
1.4.20	1.4.10	Renumbered	
1.4.21	1.2.11	Renumbered, rephrased	
1.4.22	---	Extracted from circular dated 8 Sep 2016	01.01.2017
1.4.23	1.2.12	Renumbered	
1.4.24	1.2.13	Renumbered	
1.4.25	---	New	01.03.2019
1.4.26	1.2.14	Renumbered	
1.4.27	1.2.15	Renumbered	
1.4.28	---	New	01.03.2019
1.4.29	1.2.16	Renumbered	
1.4.29a.	1.2.16(a)	Renumbered	
1.4.29b.	1.2.16(b)	Renumbered	
1.4.29c.	1.2.16(c)	Renumbered, rephrased	

Fire Code 2018	Fire Code 2013	Clause Status	Effective Date
Clause No.	Clause No.		
1.4.30	2.5.1(c)	Renumbered	
1.4.31	1.2.17	Renumbered	
1.4.32	1.2.18	Renumbered	
1.4.33	1.2.19	Renumbered	
1.4.34	2.3.9(k)(ii)	Renumbered, rephrased	
1.4.35	1.2.20	Renumbered, rephrased	
1.4.36	1.2.21	Renumbered	
1.4.36a.	1.2.21(a)	Renumbered	
1.4.36b.	1.2.21(b)	Renumbered	
1.4.36c.	1.2.21(c)	Renumbered	
1.4.36d.	1.2.21(e)	Renumbered	
1.4.36e.	1.2.21(g)	Renumbered	
1.4.37	1.2.22	Renumbered	
1.4.38	1.2.23(a)	Renumbered	
1.4.39	---	Extracted from circular dated 10 Aug 2016	10.08.2016
1.4.40	Appendix 8 (A2)	Relocated	
1.4.41	1.2.24	Renumbered, rephrased	
1.4.42	1.2.25	Renumbered	
1.4.43	1.2.25(A)	Renumbered	
1.4.44	1.2.25(B)	Renumbered	
1.4.45	1.2.26	Renumbered	
1.4.46	1.2.27	Renumbered	
1.4.47	1.2.28	Renumbered	
1.4.48	1.2.29	Renumbered	
1.4.49	1.2.30	Renumbered	
1.4.50	Nil	New	01.03.2019
1.4.51	Nil	New	01.03.2019
1.4.52	1.2.31	Renumbered	
1.4.53	1.2.34	Renumbered	
1.4.54	1.2.32	Renumbered	
1.4.55	9.1	Renumbered, rephrased	
1.4.56	1.2.33	Renumbered	
1.4.57	Appendix 22 (2)	Relocated	
1.4.58	1.2.35	Renumbered	
1.4.59	1.2.35(A)	Renumbered	
1.4.60	1.2.35(B)	Renumbered	
1.4.61	1.1.7, Appendix 5	Relocated	
1.4.62	Appendix 4 (2.1)	Relocated	
1.4.63	1.2.36	Renumbered, rephrased	
1.4.64	1.2.37	Renumbered	
1.4.65	1.2.38	Renumbered	
1.4.66	Appendix 12 (4)	Relocated	
1.4.67	1.2.39	Renumbered	
1.4.68	2.5.1(a)	Renumbered	
1.4.69	1.2.40	Renumbered	
1.4.70	1.2.41	Renumbered	
1.4.71	1.2.42	Renumbered	
1.4.72	1.2.43	Renumbered	
1.4.73	1.2.44	Renumbered, rephrased	
1.4.74	2.5.1(b)	Renumbered	

Fire Code 2018	Fire Code 2013	Clause Status	Effective Date
Clause No.	Clause No.		
1.4.75	1.2.45	Renumbered	
1.4.76	---	Extracted from circular dated 30 Oct 2015	30.04.2016
1.4.77	---	Extracted from circular dated 31 July 2014	31.01.2015
1.4.78	---	New	01.03.2019
1.4.79	1.2.46	Renumbered	
1.4.80	---	Extracted from circular dated 1 Oc 2014	01.10.2014
1.4.81	1.2.46(A)	Renumbered	
1.4.82	1.2.47	Renumbered	
1.4.83	1.2.48	Renumbered	
1.4.84	1.2.49	Renumbered	
1.4.85	1.2.50	Renumbered	
1.4.86	1.2.4	Renumbered, rephrased	
1.4.87	1.2.52	Renumbered	
1.4.88	1.2.60	Renumbered, rephrased	
1.4.89	1.2.53	Renumbered	
1.4.90	1.2.54	Renumbered	
1.4.91	1.2.51	Renumbered, rephrased	
1.4.92	1.2.55	Renumbered	
1.4.93	1.2.56	Renumbered	
1.4.94	---	New	01.03.2019
1.4.95	2.10.3	Renumbered, rephrased	
1.4.96	1.2.57	Renumbered	
1.4.97	1.2.58	Renumbered	
1.4.98	1.2.58(A)	Renumbered	
1.4.99	Appendix 8 (A.3)	Relocated	
1.4.100	2.5.1(d)	Renumbered	
1.4.101	1.2.58(B)	Renumbered	
1.4.102	---	Extracted from circular dated 1 Oct 2014	01.10.2014
1.4.103	---	Extracted from circular dated 1 Oct 2014	01.10.2014
1.4.104	Appendix 12 (3)	Relocated	
1.4.105	1.2.59	Renumbered	
1.4.106	1.2.60	Renumbered, rephrased	
1.4.107	---	New	01.03.2019
1.4.108	1.2.61	Renumbered	
1.4.109	1.2.62	Renumbered	
1.4.110	1.2.63	Renumbered	
1.4.111	2.9.1	Renumbered	
CHAPTER 2			
2.1	2.1	---	
2.1	2.1.1	---	
2.2	2.2	---	
2.2.1	2.2.1	---	
2.2.2	2.2.2	---	
2.2.3	2.2.3	---	
2.2.4	2.2.4	---	
2.2.5	2.2.5	---	
2.2.5a.	2.2.5	Renumbered, rephrased	
2.2.5b.	2.2.5	Renumbered, rephrased	
2.2.6	2.2.6	---	
2.2.6a.	2.2.6(a)	Renumbered	

Fire Code 2018

Fire Code 2018	Fire Code 2013	Clause Status	Effective Date
Clause No.	Clause No.		
2.2.6b.	2.2.6(b)	Renumbered	
2.2.6c.	2.2.6(c)	Renumbered	
2.2.6d.	2.2.6(e)	Renumbered	
2.2.6e.	2.2.6(f)	Renumbered	
2.2.6f.	2.2.6(g)	Renumbered	
2.2.6g.	2.2.6(h)	Renumbered	
2.2.6g.(1)	2.2.6(h)(i)	Renumbered	
2.2.6g.(2)	2.2.6(h)(ii)	Renumbered	
2.2.7	2.2.7	---	
2.2.7a.	2.2.7(a)	Renumbered	
2.2.7b.	2.2.7(b)	Renumbered	
2.2.7c.	2.2.7(c)	Renumbered	
2.2.8	2.2.8	---	
2.2.8a.	2.2.8	Renumbered, rephrased	
2.2.8b.	2.2.8	Renumbered, rephrased	
2.2.9	2.2.9	---	
2.2.9a.	2.2.9(a)	Renumbered	
2.2.9a.(1)	2.2.9(a)(i)	Renumbered	
2.2.9a.(2)	2.2.9(a)(ii)	Renumbered	
2.2.9a.(3)	2.2.9(a)(iii)	Renumbered	
2.2.9b.	2.2.9(b)	Renumbered	
2.2.9b.(1)	2.2.9(b)(i)	Renumbered	
2.2.9b.(2)	2.2.9(b)(ii)	Renumbered	
2.2.9b.(3)	2.2.9(b)(iii)	Renumbered	
2.2.9b.(4)	2.2.9(b)(iv)	Renumbered	
2.2.10	2.2.10	---	
2.2.11	2.2.11	Revised, extracted from circular dated 15 Dec 2015	16.06.2016
2.2.12	2.2.12	---	
2.2.12a.	2.2.12(a)	Renumbered	
2.2.12b.	2.2.12(b)	Renumbered	
2.2.12c.	2.2.12(c)	Renumbered	
2.2.13	2.2.13	---	
2.2.13a.	2.2.13(a)	Renumbered	
2.2.13a.(1)	2.2.13(a)(i)	Renumbered	
2.2.13a.(2)	2.2.13(a)(ii)	Renumbered	
2.2.13a.(3)	2.2.13(a)(iii)	Renumbered, rephrased	
2.2.13b.	2.2.13(b)	Renumbered, rephrased	
2.2.13b.(1)	2.2.13(b)	Renumbered, rephrased	
2.2.13b.(2)	2.2.13(b)	Renumbered, rephrased	
2.2.13b.(3)	2.2.13(b)	Renumbered, rephrased	
2.2.13b.(4)	2.2.13(b)	Renumbered, rephrased	
2.2.13b.(5)	2.2.13(b)	Renumbered, rephrased	
2.2.13b.(6)	2.2.13(b)	Renumbered, rephrased	
2.2.13b.(7)	2.2.13(b)	---	
2.2.13b.(7)(a)	2.2.13(b)(i)	Renumbered, rephrased	
2.2.13b.(7)(b)	2.2.13(b)(ii)	---	
2.2.13b.(7)(c)	2.2.13(b)(iv)	Renumbered, revised	01.03.2019
2.2.13b.(7)(c)(i)	2.2.13(b)(iv)	Renumbered, revised	01.03.2019
2.2.13b.(7)(c)(ii)	2.2.13(b)(iv)	Renumbered, revised	01.03.2019

Fire Code 2018	Fire Code 2013	Clause Status	Effective Date
Clause No.	Clause No.		
2.2.13b.(7)(c)(iii)	2.2.13(b)(iv)	Renumbered, revised	01.03.2019
2.2.13c.	2.2.13(c)	Renumbered	
2.2.13c.(1)	2.2.13(c)(i)	Renumbered	
2.2.13c.(1)(a)	2.2.13(c)(i)(1)	Renumbered	
2.2.13c.(1)(b)	2.2.13(c)(i)(2)	Renumbered	
2.2.13c.(1)(c)	2.2.13(c)(i)(4)	Renumbered	
2.2.13c.(2)	2.2.13(c)(ii)	Renumbered	
2.2.13c.(2)(a)	2.2.13(c)(ii)(1)	Renumbered	
2.2.13c.(2)(b)	2.2.13(c)(ii)(2)	Renumbered	
2.2.13c.(2)(c)	2.2.13(c)(ii)(3)	Renumbered	
2.2.14	2.2.14	---	
2.2.14a.	2.2.14(a)	Renumbered	
2.2.14b.	2.2.14(b)	Renumbered	
2.2.14c.	2.2.14(c)	Renumbered	
2.2.15	2.2.15	---	
2.2.15a.	2.2.15(a)(i)	Renumbered	
2.2.15b.	2.2.15(a)(ii)	Renumbered	
2.2.15c.	2.2.15(b)	Renumbered	
2.2.15d.	2.2.15(c)	Renumbered	
2.2.15e.	2.2.15(d)	Renumbered	
2.2.15f.	2.2.15(e)	Renumbered	
2.3	2.3	---	
2.3.1a.	2.3.1(a)	Renumbered	
2.3.1b.	---	---	
2.3.1b.(1)	2.3.1(b)	Renumbered	01.03.2019
2.3.1b.(2)	2.3.1(b)	Renumbered	01.03.2019
2.3.1b.(2)(a)	2.3.1(b)(i)	Renumbered	01.03.2019
2.3.1b.(2)(b)	2.3.1(b)(ii)	Renumbered	01.03.2019
2.3.1b.(3)	2.3.1(b)(iii)	Renumbered	01.03.2019
2.3.1b.(4)	2.3.1(b)(iv)	Renumbered	01.03.2019
2.3.1c.	---	New	01.03.2019
2.3.1c.(1)	---	New	01.03.2019
2.3.1c.(2)	---	New	01.03.2019
2.3.1c.(3)	---	New	01.03.2019
2.3.1c.(4)	---	New	01.03.2019
2.3.1c.(5)	---	New	01.03.2019
2.3.1c.(6)	---	New	01.03.2019
2.3.1c.(7)	---	New	01.03.2019
2.3.2	2.3.2	---	
2.3.2a.	2.3.3(a)	Renumbered	
2.3.2b.	2.3.3(b)	Renumbered	
2.3.2b.(1)	2.3.3(b)(i)	Renumbered	
2.3.2b.(2)	2.3.3(b)(ii)	Renumbered	
2.3.2b.(3)	2.3.3(b)(iii)	Renumbered	
2.3.2b.(4)	2.3.3(b)(iv)	Renumbered	
2.3.2b.(5)	2.3.3(b)(v)	Renumbered	
2.3.2b.(6)	2.3.3(b)(vi)	Renumbered	
2.3.2c.	2.3.3(c)	Renumbered	
2.3.2c.(1)	2.3.3(c)(i)	Renumbered	
2.3.2c.(2)	2.3.3(c)(ii)	Renumbered	

Fire Code 2018	Fire Code 2013	Clause Status	Effective Date
Clause No.	Clause No.		
2.3.2c.(3)	2.3.3(c)(iii)	Renumbered	
2.3.2c.(4)	2.3.3(c)(iv)	Renumbered	
2.3.2c.(5)	2.3.3(c)(v)	Renumbered	
2.3.2d.	2.3.3(d)	Renumbered	
2.3.2d.(1)	2.3.3(d)(i)	Renumbered	
2.3.2d.(2)	2.3.3(d)(ii)	Renumbered	
2.3.3	2.3.3	---	
2.3.3a.	2.3.3(a)	Renumbered	
2.3.3a.(1)	2.3.3(a)(i)	Renumbered	
2.3.3a.(2)	2.3.3(a)(ii)	Renumbered	
2.3.3a.(3)	2.3.3(a)(iii)	Renumbered	
2.3.3a.(4)	2.3.3(a)(iv)	Renumbered	
2.3.3a.(4)(a)	2.3.3(a)(iv)(1)	Renumbered, revised	01.03.2019
2.3.3a.(4)(b)	2.3.3(a)(iv)(2)	Renumbered	
2.3.3a.(4)(b)(i)	2.3.3(a)(iv)(2)	Renumbered	
2.3.3a.(4)(b)(ii)	2.3.3(a)(iv)(2)	Renumbered	
2.3.3a.(4)(b)(iii)	2.3.3(a)(iv)(2)	Renumbered	
2.3.3a.(4)(b)(iv)	2.3.3(a)(iv)(2)	Renumbered	
2.3.3a.(4)(b)(v)	2.3.3(a)(iv)(2)	Renumbered	
2.3.3a.(4)(b)(vi)	2.3.3(a)(iv)(2)	Renumbered	
2.3.3b.	2.3.3(b)	Renumbered	
2.3.3b.(1)	---	New	01.03.2019
2.3.3b.(1)(a)	---	New	01.03.2019
2.3.3b.(1)(b)	---	New	01.03.2019
2.3.3b.(2)	2.3.3(b)(i)	Renumbered	
2.3.3b.(2)(a)	2.3.3(b)(i)	Renumbered	
2.3.3b.(2)(b)	2.3.3(b)(ii)	Renumbered	
2.3.3b.(2)(b)(i)	2.3.3(b)(ii)(1)	Renumbered	
2.3.3b.(2)(b)(ii)	2.3.3(b)(ii)(2)	Renumbered	
2.3.3b.(2)(c)	2.3.3(b)(iii)	Renumbered	
2.3.3b.(3)	2.3.3(b)(iv)	Renumbered	
2.3.3c.	2.3.3(c)	Renumbered	
2.3.3c.(1)	2.3.3(c)(i)	Renumbered, rephrased	
2.3.3c.(1)(a)	2.3.3(c)(i)	Renumbered, rephrased	
2.3.3c.(1)(b)	2.3.3(c)(i)	Renumbered	
2.3.3c.(1)(c)	---	New	01.03.2019
2.3.3c.(2)	2.3.3(c)(i)	Renumbered	
2.3.3c.(2)(a)	2.3.3(c)(i)(1)	Renumbered	
2.3.3c.(2)(b)	2.3.3(c)(i)(2)	Renumbered	
2.3.3c.(2)(c)	2.3.3(c)(i)(3)	Renumbered	
2.3.3c.(2)(d)	2.3.3(c)(i)(4)	Renumbered	
2.3.3c.(3)	2.3.3(c)(ii)	Renumbered	
2.3.3c.(3)(a)	2.3.3(c)(ii)(1)	Renumbered	
2.3.3c.(3)(b)	2.3.3(c)(ii)(2)	Renumbered	
2.3.3c.(3)(c)	2.3.3(c)(ii)(3)	Renumbered	
2.3.3c.(3)(d)	2.3.3(c)(ii)(4)	Renumbered	
2.3.3c.(3)(e)	2.3.3(c)(ii)(5)	Renumbered	
2.3.3c.(3)(e)(i)	2.3.3(c)(ii)(5)	Renumbered	
2.3.3c.(3)(e)(ii)	2.3.3(c)(ii)(5)	Renumbered	
2.3.3c.(3)(e)(iii)	2.3.3(c)(iii)	Renumbered	

Fire Code 2018	Fire Code 2013	Clause Status	Effective Date
Clause No.	Clause No.		
2.3.3d.	2.3.3(d)	Renumbered	
2.3.3d.(1)	2.3.3(d)(i)	Renumbered	
2.3.3d.(2)	2.3.3(d)(ii)	Renumbered	
2.3.3d.(3)	---	New	01.03.2019
2.3.3d.(4)	---	New	
2.3.3d.(4)(a)	---	New	01.03.2019
2.3.3d.(4)(b)	---	New	01.03.2019
2.3.3d.(4)(c)	---	New	01.03.2019
2.3.3d.(5)	---	New	01.03.2019
2.3.3d.(6)	2.3.3(e)	Renumbered	
2.3.3d.(6)(a)	2.3.3(e)(i)	Renumbered, revised	01.03.2019
2.3.3d.(6)(b)	2.3.3(e)(ii)	Renumbered	
2.3.3d.(7)	2.3.3(f)	Renumbered	
2.3.3d.(8)	2.3.3(g)	Renumbered	
2.3.3d.(9)	2.3.3(h)	Renumbered, revised	01.03.2019
2.3.4	2.3.4	---	
2.3.4a.	2.3.4(a)	Renumbered	
2.3.4b.	2.3.4(b)	Renumbered	
2.3.3c.	2.3.4(c)	Renumbered	
2.3.4d.	2.3.4(d)	Renumbered	
2.3.4e.	2.3.4(e)	Renumbered	
2.3.5	2.3.5	---	
2.3.5a.	2.3.5(a)	Renumbered	
2.3.5b.	2.3.5(b)	Renumbered	
2.3.5c.	2.3.5(c)	Renumbered	
2.3.5d.	2.3.5(d)	Renumbered	
2.3.5d.(1)	2.3.5(d)(i)	Renumbered	
2.3.5d.(2)	2.3.5(d)(ii)	Renumbered	
2.3.5d.(3)	2.3.5(d)(iii)	Renumbered	
2.3.5d.(4)	2.3.5(d)(iv)	Renumbered	
2.3.6	2.3.6	---	
2.3.6a.	2.3.6(a)	Renumbered	
2.3.6b.	2.3.6(b)	Renumbered	
2.3.7	2.3.7	---	
2.3.7a.	2.3.7(a)	Renumbered, rephrased	
2.3.7b.	2.3.7(a)	Renumbered, rephrased	
2.3.7c.	2.3.7(a)	Renumbered, rephrased	
2.3.7d.	2.3.7(a)	Renumbered, rephrased	
2.3.7e.	2.3.7(b)	Renumbered	
2.3.7f.	2.3.7(c)	Renumbered	
2.3.8	2.3.8	---	
2.3.8a.	2.3.8(a)	Renumbered	
2.3.8b.	2.3.8(b)	Renumbered	
2.3.8c.	2.3.8(c)	Renumbered	
2.3.8c.(1)	2.3.8(c)(i)	Renumbered	
2.3.8c.(2)	2.3.8(c)(ii)	Renumbered	
2.3.8c.(3)	2.3.8(c)(iii)	Renumbered	
2.3.8d.	2.3.8(d)	Renumbered	
2.3.8e.	2.3.8(e)	Renumbered	
2.3.8f.	2.3.8(f)	Renumbered	

Fire Code 2018

Fire Code 2018	Fire Code 2013	Clause Status	Effective Date
Clause No.	Clause No.		
2.3.8g.	2.3.8(g)	Renumbered	
2.3.9	2.3.9	---	
2.3.9a.	2.3.9(a)	Renumbered	
2.3.9b.	2.3.9(b)	Renumbered	
2.3.9c.	2.3.9(c)	Renumbered	
2.3.9c.(1)	2.3.9(c)(i)	Renumbered	
2.3.9c.(2)	2.3.9(c)(ii)	Renumbered	
2.3.9c.(3)	2.3.9(c)(iii)	Renumbered	
2.3.9c.(4)	2.3.9(c)(iv)	Renumbered	
2.3.9d.	2.3.9(d)	Renumbered	
2.3.9d.(1)	2.3.9(d)(i)	Renumbered	
2.3.9d.(2)	2.3.9(d)(ii)	Renumbered	
2.3.9d.(3)	---	New	01.03.2019
2.3.9e.	2.3.9(e)	Renumbered	
2.3.9f.	2.3.9(f)	Renumbered	
2.3.9g.	2.3.9(g)	Renumbered	
2.3.9h.	2.3.9(h)	Renumbered	
2.3.9h.(1)	2.3.9(h)	Renumbered	
2.3.9h.(1)(a)	2.3.9(h)	Renumbered	
2.3.9h.(1)(b)	2.3.9(h)	Renumbered	
2.3.9h.(1)(c)	2.3.9(h)	Renumbered	
2.3.9h.(2)	2.3.9(h)(i)	Renumbered	
2.3.9h.(2)(a)	2.3.9(h)	Renumbered	
2.3.9h.(2)(b)	2.3.9(h)(i)	Renumbered	
2.3.9h.(2)(c)	2.3.9(h)(ii)	Renumbered	
2.3.9h.(2)(d)	2.3.9(h)(iii)	Renumbered	
2.3.9h.(2)(e)	2.3.9(h)(iv)	Renumbered	
2.3.9h.(2)(e)(i)	2.3.9(h)(iv)(1)	Renumbered	
2.3.9h.(2)(e)(ii)	2.3.9(h)(iv)(2)	Renumbered	
2.3.9i.	2.3.9(i)	Renumbered	
2.3.9j.	2.3.9(j)	Renumbered, revised	01.03.2019
2.3.9j.(1)	2.3.9(j)	Renumbered, revised	01.03.2019
2.3.9j.(2)	2.3.9(j)	Renumbered, revised	01.03.2019
2.3.9j.(3)	2.3.9(j)	Renumbered, revised	01.03.2019
2.3.9k.	2.3.9(k)	Renumbered	
2.3.9k.(1)	2.3.9(k)	Renumbered	
2.3.9k.(1)(a)	2.3.9(k)(i)	Renumbered	
2.3.9k.(1)(b)	2.3.9(k)(ii)	Renumbered	
2.3.9k.(2)	---	New	01.03.2019
2.3.9k.(3)	2.3.9(k)(iii)	Renumbered	
2.3.9l.	2.3.9(l)	Renumbered	
2.3.9l.(1)	2.3.9(l)(i)	Renumbered	
2.3.9l.(2)	2.3.9(l)(ii)	Renumbered	
2.3.9l.(3)	2.3.9(l)(iii)	Renumbered	
2.3.9l.(4)	2.3.9(l)(iv)	Renumbered	
2.3.9l.(5)	---	New	01.03.2019
2.3.10	---	New	01.03.2019
2.3.10a.	---	New	01.03.2019
2.3.10b.	---	New	01.03.2019
2.3.10c.	---	New	01.03.2019

Fire Code 2018	Fire Code 2013	Clause Status	Effective Date
Clause No.	Clause No.		
2.3.10d.	---	New	01.03.2019
2.3.10e.	---	New	01.03.2019
2.3.10f.	---	New	01.03.2019
2.3.11	---	New	01.03.2019
2.3.11a.	---	New	01.03.2019
2.3.11a.(1)	---	New	01.03.2019
2.3.11a.(2)	---	New	01.03.2019
2.3.11b.	---	New	01.03.2019
2.3.11b.(1)	---	New	01.03.2019
2.3.11b.(2)	---	New	01.03.2019
2.3.11b.(3)	---	New	01.03.2019
2.3.11b.(4)	---	New	01.03.2019
2.3.11b.(5)	---	New	01.03.2019
2.3.11b.(6)	---	New	01.03.2019
2.3.12	1.2.60	Renumbered	
2.3.12a.	1.2.60	Renumbered	
2.3.12b.	1.2.60(a)	Renumbered	
2.3.12b.(1)	1.2.60(a)(i)	Renumbered	
2.3.12b.(2)	1.2.60(a)(ii)	Renumbered	
2.3.12b.(3)	1.2.60(c)	Renumbered	
2.3.12c.	1.2.60(c)	Renumbered	
2.3.12d.	1.2.60(b)	Renumbered	
2.3.12e.	1.2.60(d)	Renumbered	
2.3.12e.(1)	1.2.60(d)(i)	Renumbered	
2.3.12e.(2)	1.2.60(d)(ii)	Renumbered	
2.3.12e.(3)	1.2.60(d)(iii)	Renumbered	
2.4	Appendix 20	Relocated	
2.4.1	Appendix 20 (1.1, 2.2 & 3.1.1)	Relocated, extracted from circulars dated 21 Jan 2011, 25 Jun 2013 and 2 Jul 2015, revised	01.11.2011 25.06.2013 02.07.2015
2.4.1a.	Appendix 20	Relocated	
2.4.1a.(1)	Appendix 20	Relocated	
2.4.1a.(2)	Appendix 20	Relocated	
2.4.1a.(3)	Appendix 20	Relocated	
2.4.1a.(4)	Appendix 20	Relocated	
2.4.1b.	Appendix 20	Relocated	
2.4.2	Appendix 20 (3.2.3)	Relocated, rephrased	
2.4.2a.	Appendix 20	Relocated	
2.4.2b.	Appendix 20	Relocated	
2.4.2b.(1)	Appendix 20	Relocated	
2.4.2b.(2)	Appendix 20	Relocated	
2.4.2b.(2)(a)	Appendix 20	Relocated	
2.4.2b.(2)(b)	Appendix 20	Relocated	
2.4.2b.(2)(c)	Appendix 20	Relocated	
2.4.2b.(2)(d)	Appendix 20	Relocated	
2.4.2b.(3)	Appendix 20	Relocated	
2.4.2c.	Appendix 20	Relocated	
2.4.3	Appendix 20 (3.2.6)	Relocated	
2.4.3a.	Appendix 20	Relocated	
2.4.3b.	Appendix 20	Relocated	

Fire Code 2018	Fire Code 2013	Clause Status	Effective Date
Clause No.	Clause No.		
2.4.3c.	Appendix 20	Relocated	
2.4.3d.	Appendix 20	Relocated	
2.4.4	Appendix 20 (3.2.7)	Relocated	
2.4.4a.	Appendix 20 (3.2.8)	Relocated	
2.4.4b.	Appendix 20 (3.2.9)	Relocated	
2.4.4c.	Appendix 20 (3.2.10)	Relocated, revised	01.03.2019
2.4.5	Appendix 20 (3.2.5)	Relocated	
2.4.6	Appendix 20 (4)	Relocated	
2.4.6a.	Appendix 20 (4.1)	Relocated	
2.4.6b.	Appendix 20 (4.2)	Relocated	
2.4.7	Appendix 20 (5)	Relocated	
CHAPTER 3			
3.1	3.1	---	
3.2	3.2	---	
3.2.1	3.2.1	---	
3.2.1a.	3.2.1(b)(i)	Renumbered	
3.2.1b.	3.2.1(b)(ii)	Renumbered	
3.2.2a.	3.2.2(a)	Renumbered	
3.2.2b.	3.2.2(b)	Renumbered	
3.2.2b.(1)	3.2.2(b)(i)	Renumbered	
3.2.2b.(2)	3.2.2(b)(ii)	Renumbered	
3.2.3a.	3.2.3(a)	Renumbered	
3.2.3b.	3.2.3(b)	Renumbered	
3.2.4a	3.2.4(a)	Renumbered	
3.2.4b.	3.2.4(b)	Renumbered	
3.2.5a.	3.2.5(a)	Renumbered	
3.2.5b.	3.2.5(b)	Renumbered	
3.2.5b.(1)	3.2.5(b)(i)	Renumbered	
3.2.5b.(2)	3.2.5(b)(ii)	Renumbered	
3.2.5b.(3)	3.2.5(b)(iii)	Renumbered	
3.2.5c.	3.2.5(c)	Renumbered	
3.2.5c.(1)	3.2.5(c)(i)	Renumbered	
3.2.5c.(2)	3.2.5(c)(ii)	Renumbered	
3.2.5c.(2)(a)	3.2.5(c)(ii)	Renumbered	
3.2.5c.(2)(b)	3.2.5(c)(ii)	Renumbered	
3.2.5d.	3.2.5(d)	Renumbered	
3.2.5e.	3.2.5(e)	Renumbered	
3.2.5f.	3.2.5(f)	Renumbered	
3.2.5f.(1)	3.2.5(f)(i)	Renumbered	
3.2.5f.(1)(a)	3.2.5(f)(ii)	Renumbered	
3.2.5f.(1)(b)	3.2.5(f)(iii)	Renumbered	
3.2.5f.(1)(c)	3.2.5(f)(iv)	Renumbered	
3.2.5f.(1)(d)	3.2.5(f)(v)	Renumbered	
3.2.5f.(1)(a)	3.2.5(f)(v)(1)	Renumbered	
3.2.5f.(1)(b)	3.2.5(f)(v)(2)	Renumbered	
3.2.5f.(1)(c)	3.2.5(f)(v)(3)	Renumbered	
3.2.5f.(1)(d)	3.2.5(f)(v)(4)	Renumbered	
3.2.5f.(1)(d)(i)	3.2.5(f)(v)(4)	Renumbered	
3.2.5f.(1)(d)(ii)	3.2.5(f)(v)(4)	Renumbered	
3.2.5f.(2)	3.2.5(f)(ii)	Renumbered	

Fire Code 2018	Fire Code 2013	Clause Status	Effective Date
Clause No.	Clause No.		
3.2.5f.(3)	3.2.5(f)(iii)	Renumbered	
3.2.5f.(4)	3.2.5(f)(iv)	Renumbered	
3.2.5f.(5)	3.2.5(f)(v)(4)	Renumbered	
3.2.5g.	3.2.5(k)	Renumbered	
3.2.5h.	3.2.5(l)	Renumbered	
3.2.5h.(1)	3.2.5(l)(i)	Renumbered	
3.2.5h.(2)	3.2.5(l)(ii)	Renumbered	
3.2.5i.	3.2.5(n)	Renumbered	
3.2.5j.	3.2.5(o)	Renumbered	
3.2.5j.(1)	3.2.5(o)(i)	Renumbered	
3.2.5j.(2)	3.2.5(o)(ii)	Renumbered	
3.2.5j.(3)	---	New	01.03.2019
3.2.6	3.2.6	---	
3.2.6a.	3.2.6(a)	Renumbered	
3.2.6b.	3.2.6(b)	Renumbered	
3.2.6c.	3.2.6(c)	Renumbered	
3.2.6d.	3.2.6(d)	Renumbered	
3.2.6e.	3.2.6(e)	Renumbered	
3.2.6f.	3.2.6(f)	Renumbered	
3.2.7	3.2.7	---	
3.2.7a.	3.2.7(a)	Renumbered	
3.2.7b.	3.2.7(b)	Renumbered	
3.2.7c.	3.2.7(c)	Renumbered	
3.2.8	3.2.8	---	
3.2.8a.	3.2.8(c)(i)	Renumbered	
3.2.8b.	3.2.8(c)(ii)	Renumbered	
3.2.9	3.2.9	---	
3.3	3.3	---	
3.3.1	3.3.4	Renumbered	
3.3.1a.	3.3.4(a)	Renumbered	
3.3.1b.	3.3.4(b)	Renumbered	
3.3.1c.	3.3.4(c)	Renumbered	
3.3.1d.	3.3.4(d)	Renumbered	
3.3.2	3.3.1	Renumbered, revised	
3.3.2a.	3.3.1(a)	Renumbered, revised	01.03.2019
3.3.2b.	3.3.1(b)	Renumbered, revised	01.03.2019
3.3.3.a	3.3.2(a)	Renumbered	
3.3.3.b	3.3.2(b)	Renumbered, rephrased	
3.3.3b.(1)	3.3.2(b)(i)	Renumbered	
3.3.3b.(2)	3.3.2(b)(ii)	Renumbered	
3.3.3b.(3)	3.3.2(b)(iii)	Renumbered	
3.3.3b.(4)	3.3.2(b)(iv)	Renumbered	
3.3.3b.(5)	3.3.2(b)(v)	Renumbered	
3.3.3b.(6)	3.3.2(b)(vi)	Renumbered	
3.3.3b.(7)	3.3.2(b)(vii)	Renumbered	
3.3.4	3.3.3	Renumbered	
3.3.4a.	3.3.3(a)	Renumbered	
3.3.4b.	3.3.3(b)	Renumbered	
3.3.4c.	3.3.3(c)	Renumbered	
3.3.5	3.3.6	Renumbered	

Fire Code 2018

Fire Code 2018	Fire Code 2013	Clause Status	Effective Date
Clause No.	Clause No.		
3.3.6	3.3.7	Renumbered	
3.3.6a.	3.3.7	Renumbered	
3.3.6a.(1)	3.3.7(i)	Renumbered	
3.3.6a.(2)	3.3.7(ii)	Renumbered	
3.3.6a.(3)	3.3.7(iii)	Renumbered	
3.3.6a.(4)	3.3.7(iv)	Renumbered	
3.3.6a.(5)	3.3.7(iv)	Renumbered	
3.3.6a.(6)	3.3.7(iv)	Renumbered	
3.3.6.b	---	Extracted from circular dated 13 Nov 2014	13.11.2014
3.3.6b.(1)	---		
3.3.6b.(2)	---		
3.3.6b.(3)	---		
3.4	3.4	---	
3.4.1	3.4.1	---	
3.4.2	3.4.2	---	
3.4.2a.	3.4.2(a)	Renumbered	
3.4.2b.	3.4.2(b)	Renumbered	
3.5	3.5	---	
3.5.1	3.5.1	---	
3.5.1a.	3.5.1(a)	Renumbered	
3.5.1a.(1)	3.5.1(a)(i)	Renumbered	
3.5.1a.(2)	3.5.1(a)(ii)	Renumbered	
3.5.1b.	3.5.1(b)	Renumbered	
3.5.2	3.5.2	Renumbered	
3.5.2a.	3.5.2(a)	Renumbered	
3.5.2a.(1)	3.5.2(a)(ii)(1)	Renumbered	
3.5.2a.(2)	3.5.2(a)(ii)(2)	Renumbered	
3.5.2a.(3)	3.5.2(a)(ii)(3)	Renumbered	
3.5.2b.	3.5.2(b) 3.5.2(b)(i)	Renumbered	
3.5.2b.(1)	3.5.2(b)(i)(1)	Renumbered	
3.5.2b.(2)	3.5.2(b)(i)(2)	Renumbered	
3.5.3	3.5.3	---	
3.5.3a.	3.5.3(a)	Renumbered	
3.5.3b.	3.5.3(b) 3.5.3(b)(i) 3.5.3(b)(ii)	Renumbered	
3.5.3c.	3.5.3(c)	Renumbered	
3.5.3d.	3.5.3(a)	Renumbered	
3.5.3e	3.5.3(a)	Renumbered	
3.5.3e.(1)	3.5.3(a)	Renumbered	
3.5.3e.(2)	3.5.3(a)	Renumbered	
3.5.4	3.5.4	---	
3.5.4a.	3.5.4(a)	Renumbered, rephrased	
3.5.4a.(1)	3.5.4(b)	Renumbered	
3.5.4a.(2)	3.5.4(b)	Renumbered	
3.5.4a.(2)(a)	3.5.4(b)	Renumbered	
3.5.4a.(2)(b)	3.5.4(b)	Renumbered	
3.5.4b.	---	New	01.03.2019
3.5.5	3.5.5	---	
3.5.6	3.5.6	---	
3.5.7	3.5.7	---	

Fire Code 2018	Fire Code 2013	Clause Status	Effective Date
Clause No.	Clause No.		
3.5.7a.	3.5.7	Renumbered	
3.5.7a.(1)	3.5.7(a)	Renumbered	
3.5.7a.(2)	3.5.7(b)	Renumbered	
3.5.7b.	3.5.7(c)	Renumbered	
3.5.7b.(1)	3.5.7(c)	Renumbered	
3.5.7b.(2)	3.5.7(c)	Renumbered	
3.5.7b.(3)	---	New	01.03.2019
3.5.7b.(4)	---	New	01.03.2019
3.5.7b.(5)	---	New	01.03.2019
3.5.8	---	New	01.03.2019
3.5.9	---	New	01.03.2019
3.5.10	---	New	01.03.2019
3.6	3.6	---	
3.6.1	3.6.1	---	
3.6.1a.	3.6.1	Renumbered	
3.6.1a.(1)	3.6.1(a)	Renumbered	
3.6.1a.(2)	3.6.1(b)	Renumbered	
3.6.1a.(3)	3.6.1(c)	Renumbered	
3.6.1a.(4)	3.6.1(d)	Renumbered	
3.6.1b.	3.6.1(e)	Renumbered	
3.6.2	3.6.2	---	
3.6.2a.	3.6.2(a)	Renumbered	
3.6.2b.	3.6.2(b)	Renumbered	
3.6.2c.	3.6.2(c)	Renumbered	
3.6.3	3.6.3	---	
3.6.4	3.6.4	---	
3.6.5	3.6.5	---	
3.7	3.7	---	
3.7.1	3.7.1	---	
3.7.1a.	3.7.1(a)	Renumbered	
3.7.1b.	3.7.1(b)	Renumbered	
3.7.1c.	3.7.1(c)	Renumbered	
3.7.1d.	3.7.1(d)	Renumbered	
3.7.2	3.7.2	---	
3.7.2a.	3.7.2(a)	Renumbered	
3.7.2b.	3.7.2(b)	Renumbered	
3.7.2c.	3.7.2(c)	Renumbered	
3.7.3	3.7.3	---	
3.7.3a.	3.7.3(a)	Renumbered	
3.7.3b.	3.7.3(b)	Renumbered	
3.7.4	3.7.4	---	
3.7.5	3.7.5	---	
3.7.6	3.7.6	---	
3.7.7	3.7.7	---	
3.7.7a.	3.7.7	Renumbered	
3.7.7b.	3.7.8	Renumbered	
3.7.7c.	3.7.9	Renumbered	
3.7.7c.(1)	3.7.9(a)	Renumbered	
3.7.7c.(2)	3.7.9(b)	Renumbered	
3.7.7d.	3.7.10	Renumbered	

Fire Code 2018

Fire Code 2018	Fire Code 2013	Clause Status	Effective Date
Clause No.	Clause No.		
3.7.7d.(1)	3.7.10(a)	Renumbered	
3.7.7d.(1)(a)	3.7.10(a)(i)	Renumbered	
3.7.7d.(1)(b)	3.7.10(a)(ii)	Renumbered	
3.7.7d.(2)	3.7.10(b)	Renumbered	
3.7.7d.(2)(a)	3.7.10(b)(i) & 3.7.10(c)(ii)	Renumbered	
3.7.7d.(2)(b)	3.7.10(b)(ii)	Renumbered	
3.7.7d.(3)	3.7.10(c)(i)	Renumbered	
3.7.8	---	New	01.03.2019
3.7.9	---	New	01.03.2019
3.7.9.a	---	New	01.03.2019
3.7.9.b	---	New	01.03.2019
3.7.9b.(1)	---	New	01.03.2019
3.7.9b.(2)	---	New	01.03.2019
3.8	3.8	---	
3.8.1	3.8.1	---	
3.8.2	3.8.2	---	
3.8.2a.	3.8.2(a)	Renumbered	
3.8.2b.	3.8.2(b)	Renumbered	
3.8.2c.	3.8.2(c)	Renumbered	
3.8.3	3.8.3	---	
3.8.3a.	3.8.3	Renumbered	
3.8.3a.(1)	3.8.3(a)	Renumbered	
3.8.3a.(2)	3.8.3(b)	Renumbered	
3.8.3a.(3)	3.8.3(c)	Renumbered	
3.8.3a.(3)(a)	3.8.3(c)(i)	Renumbered	
3.8.3a.(3)(b)	3.8.3(c)(ii)	Renumbered	
3.8.3a.(3)(c)	3.8.3(c)(iii)	Renumbered	
3.8.3b.	3.8.3(c)(iii)	Renumbered	
3.8.4	3.8.4	---	
3.8.5	3.8.5	---	
3.8.5a.	3.8.5(a)	Renumbered	
3.8.5b.	3.8.5(b)	Renumbered	
3.8.6	3.8.6	---	
3.8.6a.	3.8.6	Renumbered	
3.8.6b.	3.8.6	Renumbered	
3.8.6b.(1)	3.8.6	Renumbered	
3.8.6b.(2)	3.8.6	Renumbered, revised	01.03.2019
3.8.7	3.8.7	---	
3.8.7a.	3.8.7(a)	Renumbered	
3.8.7a.(1)	3.8.7(a)(i)	Renumbered	
3.8.7a.(2)	3.8.7(a)(ii)	Renumbered	
3.8.7a.(3)	3.8.7(a)(iii)	Renumbered	
3.8.7b.	3.8.7(b)	Renumbered	
3.8.7b.(1)	3.8.7(b)(i)	Renumbered	
3.8.7b.(2)	3.8.7(b)(ii)	Renumbered	
3.8.7b.(3)	3.8.7(b)(iii)	Renumbered	
3.8.7b.(4)	3.8.7(b)(iv)	Renumbered	
3.8.7b.(5)	3.8.7(b)(v)	Renumbered	
3.8.7b.(6)	3.8.7(b)(v)	Renumbered	
3.8.8	3.8.8	---	

Fire Code 2018	Fire Code 2013	Clause Status	Effective Date
Clause No.	Clause No.		
3.8.8a.	3.8.8(a)	Renumbered	
3.8.8b.	3.8.8(b)	Renumbered	
3.8.8c.	3.8.8(c)	Renumbered	
3.8.8d.	3.8.8(d)	Renumbered	
3.8.8e.	3.8.8(e)	Renumbered	
3.8.8f.	3.8.8(f)	Renumbered	
3.8.8g.	3.8.8(g)	Renumbered	
3.8.9	3.8.9	---	
3.8.9.a	3.8.9(a)	Renumbered	
3.8.9.b	3.8.9(b)	Renumbered, revised	
3.8.9b.(1)	---	New	01.03.2019
3.8.9b.(2)	---	New	01.03.2019
3.8.9b.(3)	---	New	01.03.2019
3.8.9c.	3.8.9(c)	Renumbered	
3.8.9d.	3.8.9(d)	Renumbered	
3.9	3.9	---	
3.9.1	3.9.1	---	
3.9.2	3.9.2	---	
3.9.2a.	3.9.2(a)	Renumbered	
3.9.2b.	3.9.2(b)	Renumbered	
3.9.2c.	3.9.2(c)	Renumbered	
3.9.2c.(1)	3.9.2(c)(i)	Renumbered	
3.9.2c.(2)	3.9.2(c)(ii)	Renumbered	
3.9.2d.	3.9.2(d)	Renumbered	
3.9.2e.	3.9.2(e)	Renumbered	
3.9.2e.(1)	3.9.2(e)(i)	Renumbered	
3.9.2e.(2)	3.9.2(e)(ii)	Renumbered	
3.9.2e.(3)	3.9.2(e)(iii)	Renumbered	
3.9.2f.	3.9.2(f)	Renumbered	
3.9.3	3.9.3	---	
3.9.3a.	3.9.3(a)	Renumbered	
3.9.3b.	---	New	01.03.2019
3.9.3b.(1)	---	New	01.03.2019
3.9.3b.(2)	---	New	01.03.2019
3.9.3b.(3)	---	New	01.03.2019
3.9.3c.	---	New	01.03.2019
3.9.3c.(1)	---	New	01.03.2019
3.9.3c.(2)	---	New	01.03.2019
3.9.3c.(3)	---	New	01.03.2019
3.9.3.d	---	New	01.03.2019
3.9.3.e	3.9.3(b)	Renumbered	
3.9.3e.(1)	3.9.3(b)(i)	Renumbered	
3.9.3e.(2)	3.9.3(b)(2)	Renumbered	
3.9.3e.(3)	3.9.3(b)(3)	Renumbered	
3.9.4	3.9.4	---	
3.9.4a.	3.9.4(a)	Renumbered	
3.9.4a.(1)	3.9.4(a)(i)	Renumbered	
3.9.4a.(2)	3.9.4(a)(ii)	Renumbered	
3.9.4b.	3.9.4(b)	Renumbered	
3.9.4b.(1)	3.9.4(b)(i)	Renumbered	

Fire Code 2018

Fire Code 2018	Fire Code 2013	Clause Status	Effective Date
Clause No.	Clause No.		
3.9.4b.(2)	3.9.4(b)(ii)	Renumbered	
3.9.4c.	3.9.4(c)	Renumbered	
3.9.5	3.9.5	---	
3.9.6	3.9.6(a)	Renumbered	
3.9.6a.	3.9.6(a)(i)	Renumbered	
3.9.6b.	3.9.6(a)(ii)	Renumbered	
3.9.6c.	3.9.6(a)(iii)	Renumbered	
3.9.6d.	3.9.6(a)(iv)	Renumbered	
3.9.7	3.9.6(b)	Renumbered	
3.9.7a.	3.9.6(a)(i)	Renumbered	
3.9.7b.	3.9.6(a)(ii)	Renumbered	
3.9.8	---	New	01.03.2019
3.10	3.10	---	
3.10.1	3.10.1	---	
3.10.2	3.10.2	---	
3.10.3	3.10.3	---	
3.10.4	3.10.4	---	
3.11	3.11	---	
3.11.1	3.11.1	---	
3.11.2	3.11.2	---	
3.11.3	3.11.3	---	
3.11.4	3.11.4	---	
3.11.5	3.11.5	---	
3.11.5a.	3.11.5(b)	Renumbered	
3.11.5b.	3.11.5(a)	Renumbered	
3.11.6	3.11.6	---	
3.11.6a.	3.11.6(a)	Renumbered	
3.11.6b.	3.11.6(b)	Renumbered	
3.11.6c.	3.11.6(c)	Renumbered	
3.11.6d.	3.11.6(d)	Renumbered	
3.11.6e.	3.11.6(e)	Renumbered	
3.11.7	3.11.7	---	
3.11.7a.	3.11.7(a)	Renumbered	
3.11.7b.	3.11.7(b)	Renumbered	
3.11.7c.	3.11.7(c)	Renumbered	
3.11.7d.	3.11.7(d)	Renumbered	
3.11.8	3.11.8	---	
3.11.8a.	3.11.8(a)	Renumbered	
3.11.8b.	3.11.8(b)	Renumbered	
3.11.8c.	3.11.8(c)	Renumbered	
3.11.8c.(1)	3.11.8(c)(i)	Renumbered	
3.11.8c.(2)	3.11.8(c)(ii)	Renumbered	
3.11.8c.(3)	3.11.8(c)(iii)	Renumbered	
3.11.8d.	3.11.8(d)	Renumbered	
3.11.8e.	3.11.8(e)	Renumbered	
3.11.8f.	3.11.8(f)	Renumbered	
3.11.8g.	3.11.8(g)	Renumbered	
3.11.8h.	3.11.8(h)	Renumbered	
3.11.8i	3.11.8(i)	Renumbered	
3.11.8j	3.11.8(j)	Renumbered	

Fire Code 2018	Fire Code 2013	Clause Status	Effective Date
Clause No.	Clause No.		
3.11.8k	3.11.8(k)	Renumbered	
3.11.8l	3.11.8(l)	Renumbered	
3.11.9	3.11.9	Rephrased	
3.11.9a.	3.11.9(a)	Renumbered	
3.11.9b.	3.11.9(b)	Renumbered	
3.11.9c.	3.11.9(c)	Renumbered	
3.11.9d.	3.11.9(d)	Renumbered	
3.11.9d.(1)	3.11.9(d)	Renumbered	
3.11.9d.(2)	3.11.9(d)	Renumbered	
3.11.9e.	3.11.9(e)	Renumbered	
3.11.9e.(1)	3.11.9(e)(i)	Renumbered	
3.11.9e.(2)	3.11.9(e)(iii)	Renumbered	
3.11.9e.(3)	3.11.9(e)(ii)	Renumbered	
3.11.9f.	3.11.9(f)	Renumbered	
3.11.10	3.11.10	---	
3.11.10a.	3.11.10(a)	Renumbered	
3.11.10b.	3.11.10(b)	Renumbered	
3.11.11	3.11.11	---	
3.11.11a.	3.11.11(a)	Renumbered	
3.11.11b.	3.11.11(b)	Renumbered	
3.11.11c.	3.11.11(c)	Renumbered	
3.11.12	3.11.12	---	
3.12	3.12	---	
3.12.1	3.12.1	---	
3.12.1a.	3.12.1(a)	Renumbered	
3.12.1b.	3.12.1(b)	Renumbered	
3.12.1c.	3.12.1(c)	Renumbered	
3.12.2	3.12.2	---	
3.12.3	3.12.3	---	
3.12.3a.	3.12.3(a)	Renumbered	
3.12.3b.	3.12.3(b)	Renumbered	
3.12.3b.(1)	3.12.3(b)(i)	Renumbered	
3.12.3b.(2)	3.12.3(b)(ii)	Renumbered	
3.12.3b.(3)	3.12.3(b)(iii)	Renumbered	
3.12.3b.(4)	3.12.3(b)(iv)	Renumbered	
3.12.3b.(5)	3.12.3(b)(v)	Renumbered	
3.12.3b.(6)	3.12.3(b)(v)	Renumbered	
3.13	3.13	---	
3.13.1	3.13.1	---	
3.13.1a.	3.13.1(a)	Renumbered	
3.13.1b.	3.13.1(b)	Renumbered	
3.13.2	3.13.2	---	
3.13.3	3.13.3	Rephrased	
3.13.3a.	3.13.3	Renumbered, revised	01.03.2019
3.13.3b.	3.13.3	Renumbered, revised	01.03.2019
3.13.3c.	3.13.3	Renumbered, revised	01.03.2019
3.13.3d.	3.13.3	Renumbered, revised	01.03.2019
3.13.3e.	3.13.3	Renumbered, revised	01.03.2019
3.13.4	3.13.4	---	
3.13.4a.	3.13.4(a)	Renumbered	

Fire Code 2018

Fire Code 2018	Fire Code 2013	Clause Status	Effective Date
Clause No.	Clause No.		
3.13.4a.(1)	3.13.4(a)(i)	Renumbered	
3.13.4a.(2)	3.13.4(a)(ii)	Renumbered	
3.13.4a.(3)	3.13.4(a)(iii)	Renumbered	
3.13.4b.	3.13.4(b)	Renumbered	
3.13.4c.	3.13.4(c)	Renumbered	
3.13.5	3.13.5	---	
3.13.5a.	3.13.5(a)	---	
3.13.5a.(1)	3.13.5(a)(i)	Renumbered	
3.13.5a.(2)	3.13.5(a)(ii)	Renumbered	
3.13.5b.	3.13.5(b)	Renumbered	
3.13.5b.(1)	3.13.5(b)(i)	Renumbered	
3.13.5b.(1)(a)	3.13.5(b)(i)	Renumbered	
3.13.5b.(1)(b)	3.13.5(b)(i)	Renumbered	
3.13.5b.(2)	3.13.5(b)(ii)	Renumbered	
3.13.5b.(2)(a)	3.13.5(b)(ii)	Renumbered	
3.13.5b.(2)(b)	3.13.5(b)(ii)	Renumbered	
3.13.5b.(2)(c)	3.13.5(b)(iii)	Renumbered	
3.13.5b.(3)	3.13.5(b)(iv)	Renumbered	
3.13.5b.(4)	3.13.5(b)(v)	Renumbered	
3.13.6	3.13.6	Revised	01.03.2019
3.13.7	---	New	01.03.2019
3.14	3.14	---	
3.14.1	3.14.1	---	
3.14.1a.	3.14.1	Renumbered	
3.14.1b.	Nil	New	01.03.2019
3.14.1c.	Nil	New	01.03.2019
3.14.2	3.14.2	Rephrased	
3.14.2a.	3.14.2(a)	Renumbered	
3.14.2b.	3.14.2(b)	Renumbered	
3.14.2c.	3.14.2(c)	Renumbered	
3.14.3	3.14.3	---	
3.15	3.15	---	
3.15.1	3.15.1(a)	Renumbered	
3.15.2	3.15.1(b)	Renumbered	
3.15.2a.	3.15.1(b)(i)	Renumbered	
3.15.2b.	3.15.1(b)(ii)	Renumbered	
3.15.2c.	Appendix 6	Relocated	
3.15.2c.(1)	Appendix 6	Relocated	
3.15.2c.(2)	Appendix 6	Relocated	
3.15.2c.(3)	Appendix 6	Relocated	
3.15.2c.(4)	Appendix 6	Relocated	
3.15.2c.(5)	Appendix 6	Relocated	
3.15.2d.	3.15.1(b) Note	Relocated	
3.15.3	3.15.1(c)	Renumbered	
3.15.3a.	3.15.1(c)(i)	Renumbered	
3.15.3b.	3.15.1(c)(ii)	Renumbered	
3.15.3c.	3.15.1(c)(iii)	Renumbered	
3.15.4	3.15.2	Renumbered	
3.15.4a.	3.15.2	Renumbered	
3.15.4b.	3.15.2	Renumbered	

Fire Code 2018	Fire Code 2013	Clause Status	Effective Date
Clause No.	Clause No.		
3.15.4c.	3.15.2	Renumbered	
3.15.4d.	3.15.2	Renumbered	
3.15.4e.	3.15.2	Renumbered	
3.15.5	3.15.3	Renumbered	
3.15.6	3.15.4	Renumbered	
3.15.7	3.15.5	Renumbered	
3.15.8	3.15.6 & 3.15.7	Renumbered	
3.15.8a.	3.15.6	Renumbered	
3.15.8b.	3.15.7	Renumbered	
3.15.9	3.15.8	Renumbered	
3.15.10	3.15.9	Renumbered	
3.15.11	3.15.10	Renumbered	
3.15.12	3.15.11	Renumbered	
3.15.13	3.15.12(a)	Renumbered, rephrased	
3.15.13a.	3.15.12(a)	Renumbered, rephrased	
3.15.13b.	3.15.12(a)	Renumbered, rephrased	
3.15.13c.	3.15.12(a)	Renumbered, rephrased	
3.15.13c.(1)	3.15.12(a)	Renumbered, rephrased	
3.15.13c.(1)(a)	3.15.12(a)	Renumbered, rephrased	
3.15.13c.(1)(b)	3.15.12(a)	Renumbered, rephrased	
3.15.13c.(2)	3.15.12(a)	Renumbered, rephrased	
3.15.13d.	3.15.12(a)	Renumbered, revised	01.03.2019
3.15.14	3.15.13	Renumbered	
3.15.14a.	3.15.13(a)	Renumbered	
3.15.14b.	3.15.13(b)	Renumbered	
3.15.15	3.15.14	Renumbered	
3.15.16	3.15.15	Renumbered	
3.15.17	3.15.12(b)	Renumbered	
3.15.18	3.4.3	Renumbered	
3.15.18a.	3.4.3(a)	Renumbered	
3.15.18b.	3.4.3(b)	Renumbered	
3.15.18c.	3.4.3(c)	Renumbered	
3.15.19	---	Extracted from circular dated 1 Oct 2014	01.10.2014
3.15.19a.	---	Extracted from circular dated 1 Oct 2014	01.10.2014
3.15.19a.(1)	---	Extracted from circular dated 1 Oct 2014	01.10.2014
3.15.19a.(2)	---	Extracted from circular dated 1 Oct 2014	01.10.2014
3.15.19a.(3)	---	Extracted from circular dated 1 Oct 2014	01.10.2014
3.15.19b.	---	Extracted from circular dated 1 Oct 2014	01.10.2014
3.15.19b.(1)	---	Extracted from circular dated 1 Oct 2014	01.10.2014
3.15.19b.(2)	---	Extracted from circular dated 1 Oct 2014	01.10.2014
3.15.19b.(3)	---	Extracted from circular dated 1 Oct 2014	01.10.2014
3.15.19c.	---	Extracted from circular dated 1 Oct 2014	01.10.2014
3.15.19c.(1)	---	Extracted from circular dated 1 Oct 2014	01.10.2014
3.15.19c.(2)	---	Extracted from circular dated 1 Oct 2014	01.10.2014
3.15.19c.(3)	---	Extracted from circular dated 1 Oct 2014	01.10.2014
3.15.19c.(4)	---	Extracted from circular dated 1 Oct 2014	01.10.2014
3.15.19c.(5)	---	Extracted from circular dated 1 Oct 2014	01.10.2014
3.15.19c.(6)	---	Extracted from circular dated 1 Oct 2014	01.10.2014
3.15.19c.(7)	---	Extracted from circular dated 1 Oct 2014	01.10.2014
3.15.19c.(8)	---	Extracted from circular dated 1 Oct 2014	01.10.2014

Fire Code 2018	Fire Code 2013	Clause Status	Effective Date
Clause No.	Clause No.		
3.15.20	---	Extracted from circular dated 8 May 1997	01.07.1997
CHAPTER 4			
4.2.1	4.2.1	Renumbered, revised	01.03.2019
4.2.1a.			
4.2.1b.			
4.2.1c.			
4.2.1d.			
4.2.2	4.2.2	---	
4.2.2a.	4.2.2(a)(i)	Renumbered	
4.2.2a.(1)	4.2.2(a)(i)	Renumbered	
4.2.2a.(1)(a)	4.2.2(a)(i)	Renumbered	
4.2.2a.(1)(b)	4.2.2(a)(ii)	Renumbered	
4.2.2a.(1)(c)	4.2.2(a)(i)	Renumbered	
4.2.2a.(2)	4.2.2(a)(ii)	Renumbered	
4.2.2a.(3)	4.2.2(a)(iii)	Renumbered	
4.2.2a.(3)(a)	4.2.2(a)(iii)	Renumbered	
4.2.2a.(3)(b)	---	New	01.03.2019
4.2.2a.(3)(c)	---	New	01.03.2019
4.2.2a.(4)	4.2.2(a)(iv)	Renumbered	
4.2.2a.(5)	4.2.2(a)(v)	Renumbered	
4.2.2a.(6)	4.2.2(b)(i)	Renumbered, revised	01.03.2019
4.2.2a.(6)(a)	4.2.2(b)(i)(1)	Renumbered	
4.2.2a.(6)(b)	4.2.2(b)(i)(2)	Renumbered, revised	01.03.2019
4.2.2a.(7)	4.2.2(c)	Renumbered	
4.2.2a.(8)	---	New	01.03.2019
4.2.2a.(8)(a)	---	New	01.03.2019
4.2.2a.(8)(b)	---	New	01.03.2019
4.2.2a.(8)(b)(i)	---	New	01.03.2019
4.2.2a.(8)(b)(ii)	---	New	01.03.2019
4.2.2a.(8)(c)	---	New	01.03.2019
4.2.2b.	4.2.2(d)(ii)	Renumbered, revised	01.03.2019
4.2.2c.	4.2.2(d)(iii)	Renumbered	
4.2.2d.	4.2.2(d)(iv)	Renumbered	
4.2.2e.	4.2.2(d)(v)	Renumbered	
4.2.2e.(1)	4.2.2(d)(v)	Renumbered	
4.2.2e.(2)	4.2.2(d)(vi)	Renumbered, revised	01.03.2019
4.2.2f.	4.2.2(d)(vii)	Renumbered	
4.2.2f.(1)	4.2.2(d)(vii)	Renumbered	
4.2.2f.(2)	---	New	01.03.2019
4.2.2f.(3)	---	New	01.03.2019
4.2.2f.(4)	---	New	01.03.2019
4.2.2f.(5)	---	New	01.03.2019
4.2.2g.	4.2.2(d)(viii)	Renumbered	
4.2.2h.	4.2.2(d)(ix)	Renumbered	
4.2.2i.	4.2.2(e)	Renumbered	
4.2.2i.(1)	4.2.2(e)(i) & (ii)	Renumbered, rephrased	
4.2.2i.(2)	4.2.2(e)(iii)	Renumbered, revised	01.03.2019
4.2.2i.(3)	4.2.2(e)iv)	Renumbered, revised	01.03.2019
4.2.2j.	4.2.2(d)(i)	Renumbered, revised	01.03.2019

Fire Code 2018	Fire Code 2013	Clause Status	Effective Date
Clause No.	Clause No.		
4.2.2j.(1)	4.2.2(d)(i)	Renumbered, revised	01.03.2019
4.2.2j.(2)	4.2.2(d)(i)	Renumbered, revised	01.03.2019
4.2.3	4.2.3	---	
4.2.3a.	4.2.3(a)	Renumbered, revised	01.03.2019
4.2.3b.	4.2.3(e)	Renumbered	
4.2.3c.	4.2.3(d)	Renumbered	
4.2.3d.	4.2.3(e)	Renumbered	
4.2.3e.	4.2.3(f)	Renumbered	
4.2.3e.(1)	4.2.3(f)(i)	Renumbered, rephrased	
4.2.3e.(2)	4.2.3(f)(iii)	Renumbered	
4.2.3e.(3)	4.2.3(f)	Renumbered, revised	
4.2.3e.(3)(a)	4.2.3(f)(i) & (ii)	Renumbered, revised	01.03.2019
4.2.3e.(3)(b)	4.2.3(f)(i) & (ii)	Renumbered, revised	01.03.2019
4.2.3e.(4)	4.2.3(f)(iv)	Renumbered, revised	01.03.2019
4.2.3e.(4)(a)			
4.2.3e.(4)(b)			
4.2.3e.(4)(c)			
4.2.3e.(4)(d)			
4.2.3f.	4.2.3(g)	Renumbered	
4.3	4.3	---	
4.4	4.4	---	
4.4.1	4.4.1	---	
4.4.1a.	4.4.1(a)(i)	Renumbered	
4.4.1b.	4.4.1(a)(ii)	Renumbered	
4.4.1c.	4.4.1(b)	Renumbered	
4.4.1d.	4.4.1(c)	Renumbered	
4.4.1e.	4.4.1(d)	Renumbered	
4.4.1f.	---	New	01.03.2019
4.4.2	4.4.2	Revised	01.03.2019
4.4.2a.	4.4.2(a)	Renumbered	
4.4.2a.(1)	4.2.2(a)(i)	Renumbered	
4.4.2a.(2)	4.2.2(a)(ii)	Renumbered	
4.4.2a.(2)(a)	4.2.2(a)(ii)(1)	Renumbered	
4.4.2a.(2)(b)	4.2.2(a)(ii)(2)	Renumbered	
4.4.2b.	4.4.2(b)	Renumbered	
4.4.2b.(1)	4.4.2(b)(i)	Renumbered	
4.4.2b.(2)	4.4.2(b)(ii)	Renumbered	
4.4.2b.(2)(a)	4.4.2(b)(ii)	Renumbered	
4.4.2b.(2)(b)	4.4.2(b)(ii)	Renumbered	
4.4.2b.(2)(c)	4.4.2(b)(ii)	Renumbered	
4.4.2b.(3)	4.4.2(b)(ii)	Renumbered	
4.4.2b.(3)(a)	4.4.2(b)(ii)	Renumbered	
4.4.2b.(3)(b)	4.4.2(b)(ii)	Renumbered	
4.4.2b.(3)(c)	4.4.2(b)(ii)	Renumbered	
4.4.2b.(3)(d)	4.4.2(b)(ii)	Renumbered	
4.4.2c.	4.4.2(c)	Renumbered	
4.4.3	4.4.3	---	
4.4.3a.	4.4.3(a)	Renumbered	
4.4.3b.	4.4.3(b)	Renumbered	
4.4.3c.	4.4.3(c)	Renumbered	

Fire Code 2018	Fire Code 2013	Clause Status	Effective Date
Clause No.	Clause No.		
4.4.3d.	4.4.3(d)	Renumbered	
CHAPTER 5			
5.1	5.1 & 5.1.1	Rephrased	
5.2	5.2	---	
5.2.1	5.2.1	---	
5.2.1a.	5.2.1(a)	Renumbered	
5.2.1b.	5.2.1(b)	Renumbered	
5.2.1c.	5.2.1(c)	Renumbered	
5.2.1d.	5.2.1(d)	Renumbered	
5.2.1e.	5.2.1(e)	Renumbered	
5.2.1f.	5.2.1(f)	Renumbered	
5.2.1g.	5.2.1(g)	Renumbered, revised	01.03.2019
5.2.1g.(1)	---	---	
5.2.1g.(1)(a)	5.2.1(g)(i)	Renumbered, revised	01.03.2019
5.2.1g.(1)(b)	5.2.1(g)(i)	Renumbered, revised	01.03.2019
5.2.1g.(1)(c)	5.2.1(g)(ii)	Renumbered, revised	01.03.2019
5.2.1g.(1)(d)	5.2.1(g)(iv)	Renumbered, revised	01.03.2019
5.2.1g.(1)(e)	5.2.1(g)(v)	Renumbered, revised	01.03.2019
5.2.1g.(1)(f)	5.2.1(g)(vi)	Renumbered, revised	01.03.2019
5.2.1g.(1)(g)	5.2.1(g)(vii)	Renumbered, revised	01.03.2019
5.2.1g.(1)(h)	---	New	01.03.2019
5.2.1g.(1)(i)	5.2.1(g)(x)	Renumbered, revised	
5.2.1g.(2)	---	New	01.03.2019
5.2.1g.(2)(a)	---	New	01.03.2019
5.2.1g.(2)(b)	---	New	01.03.2019
5.2.1g.(2)(c)	---	New	01.03.2019
5.2.1g.(2)(d)	---	New	01.03.2019
5.2.1g.(2)(e)	---	New	01.03.2019
5.2.1g.(2)(f)	---	New	01.03.2019
5.2.1g.(3)	---	New	01.03.2019
5.2.1h.	5.2.1(h)	Renumbered	
5.2.1h.(1)	5.2.1(h)(i)	Renumbered	
5.2.1h.(2)	5.2.1(h)(ii)	Renumbered	
5.2.2	5.2.1(i)	Renumbered	
5.2.3	5.2.1(j)	Renumbered	
5.2.3a.	5.2.1(j)(i)	Renumbered	
5.2.3b.	5.2.1(j)(ii)	Renumbered	
5.2.3c.	5.2.1(j)(iii)	Renumbered	
5.2.3d.	5.2.1(j)(iv)	Renumbered	
5.2.4	5.2.3	Renumbered	
5.2.4a.	5.2.3	Renumbered	
5.2.4b.	---	New	01.03.2019
5.2.4b.(1)	---	New	01.03.2019
5.2.4b.(2)	---	New	01.03.2019
5.2.4b.(3)	---	New	01.03.2019
CHAPTER 6			
6.1	6.1	---	
6.1.1	6.1.1	---	
6.1.1a.	6.1.1(b)	Renumbered	
6.1.1b.	6.1.1(c)	Renumbered	

Fire Code 2018	Fire Code 2013	Clause Status	Effective Date
Clause No.	Clause No.		
6.1.2	6.1.2	---	
6.1.2a.	6.1.1(a)	Renumbered	
6.1.2a.(1)	6.1.1(a)	Renumbered	
6.1.2a.(2)	6.1.1(a)	Renumbered	
6.1.2a.(3)	---	New	01.03.2019
6.1.2b.	---	Extracted from circular dated 15 Dec 2015	16.06.2016
6.1.3	6.1.2	Renumbered	
6.1.4	6.1.3	Renumbered	
6.2	6.2	---	
6.2.1	6.2.1	---	
6.2.2a.	6.2.2(a)	Renumbered	
6.2.2a.(1)	6.2.2(a)(i)	Renumbered	
6.2.2a.(2)	6.2.2(a)(ii)	Renumbered	
6.2.2a.(3)	6.2.2(a)(iii)	Renumbered	
6.2.2b.	6.2.2(b)	Renumbered	
6.2.2c.	6.2.2(c)	Renumbered, rephrased	
6.2.2c.(1)	6.2.2(d)(i)	Renumbered, rephrased	
6.2.2c.(2)	6.2.2(d)(ii)	Renumbered, rephrased	
6.2.3	6.2.3	---	
6.2.3a.	6.2.3(a)	Renumbered	
6.2.3b.	6.2.3(b)	Renumbered	
6.2.4a.	6.2.4(a)	Renumbered	
6.2.4b.	6.2.4(b)	Renumbered	
6.2.4b.(1)	6.2.4(b)(i)	Renumbered	
6.2.4b.(2)	6.2.4(b)(ii)	Renumbered	
6.2.4c.	6.2.4(c)	Renumbered	
6.2.4.d	6.2.4(d)	Renumbered	
6.2.4e.	6.2.4(e)	Renumbered	
6.2.4f.	6.2.4(f)	Renumbered	
6.2.4g.	Appendix (9)	Relocated	
6.2.5	6.2.5	---	
6.2.5a.	6.2.5(a)	Renumbered	
6.2.5a.(1)	6.2.5(a)(i)	Renumbered	
6.2.5a.(2)	6.2.5(a)(ii)	Renumbered	
6.2.5a.(3)	6.2.5(a)(iii)	Renumbered	
6.2.5b.	6.2.5(b)	Renumbered	
6.2.5b.(1)	6.2.5(b)(i)	Renumbered	
6.2.5b.(2)	6.2.5(b)(ii)	Renumbered	
6.2.5c.	---	---	
6.2.5c.(1)	6.2.5c.(i)	Renumbered	
6.2.5c.(2)	6.2.5c.(ii)	Renumbered	
6.2.5c.(3)	6.2.5c.(iii)	Renumbered	
6.2.5c.(4)	6.2.5c.(iv)	Renumbered	
6.2.5c.(5)	6.2.5c.(v)	Renumbered	
6.2.5c.(6)	6.2.5c.(vi)	Renumbered	
6.2.5c.(7)	6.2.5c.(vii)	Renumbered	
6.2.5c.(8)	6.2.5c.(viii)	Renumbered	
6.2.5c.(9)	6.2.5c.(ix)	Renumbered	
6.2.5d.	6.2.5(d)	Renumbered	
6.2.5d.(1)	6.2.5(d)(i)	Renumbered	

Fire Code 2018

Fire Code 2018	Fire Code 2013	Clause Status	Effective Date
Clause No.	Clause No.		
6.2.5d.(2)	6.2.5(d)(ii)	Renumbered	
6.2.6	6.2.6	---	
6.2.7	6.2.7	---	
6.2.7a.	6.2.7	Renumbered	
6.2.7a.(1)	6.2.7	Renumbered	
6.2.7a.(2)	6.2.7	Renumbered	
6.2.7b.	6.2.7	Renumbered	
6.2.8	6.2.8	---	
6.2.8a.	6.2.8.	Renumbered	
6.2.8a.(1)	6.2.8(a)	Renumbered	
6.2.8a.(2)	---	Extracted from circular dated 15 Dec 2015	16.06.2016
6.2.8a.(3)	6.2.8(a)	Renumbered	
6.2.8a.(3)(a)	6.2.8(a)(i)	Renumbered	
6.2.8a.(3)(b)	6.2.8(a)(ii)	Renumbered	
6.2.8a.(3)(b)(i)	6.2.8(a)(ii)(1)	Renumbered	
6.2.8a.(3)(b)(ii)	6.2.8(a)(ii)(2)	Renumbered	
6.2.8a.(3)(b)(iii)	6.2.8(a)(ii)(3)	Renumbered	
6.2.8a.(3)(b)(iv)	6.2.8(a)(ii)(4)	Renumbered	
6.2.8a.(3)(b)(v)	6.2.8(a)(ii)(5)	Renumbered	
6.2.8a.(3)(b)(vi)	---	New	01.03.2019
6.2.8a.(3)(c)	6.2.8(a)(iii)	Renumbered	
6.2.8a.(3)(c)(i)	6.2.8(a)(iii)	Renumbered	
6.2.8a.(3)(c)(ii)	6.2.8(a)(iii)	Renumbered	
6.2.8a.(3)(c)(iii)	6.2.8(a)(iii)	Renumbered, rephrased	
6.2.8a.(3)(c)(iv)	6.2.8(a)(iii)	Renumbered, rephrased	
6.2.8a.(3)(d)	6.2.8(a)(iv)	Renumbered, rephrased	
6.2.8b.	6.2.8(b)	Renumbered	
6.2.8c.	6.2.8(c)	Renumbered	
6.2.8d.	6.2.8(d)	Renumbered	
6.2.8d.(1)	6.2.8(d)	Renumbered	
6.2.8d.(2)	6.2.8(d)	Renumbered	
6.2.8d.(3)	---	New	01.03.2019
6.2.8d.(4)	---	New	01.03.2019
6.2.8e.	6.2.8(e)	Renumbered	
6.2.9	6.2.9	---	
6.3	6.3	---	
6.3.1	6.3.1	---	
6.3.1a.	6.3.1(a)	Renumbered	
6.3.1a.(1)	6.3.1(a)	Renumbered	
6.3.1a.(2)	6.3.1(c)	Renumbered	
6.3.1b.	6.3.1(b)(i) & (ii)	Revised, extracted from circular dated 11 Aug 2016	01.11.2016
6.3.1b.(1)	6.3.1(b)(i) & (ii)	Revised, extracted from circular dated 11 Aug 2016	01.11.2016
6.3.1b.(2)	6.3.1(b)(i) & (ii)	Revised, extracted from circular dated 11 Aug 2016	01.11.2016
6.3.1b.(3)	6.3.1(b)(i) & (ii)	Revised, extracted from circular dated 11 Aug 2016	01.11.2016
6.3.1c.	6.3.1(d)	Renumbered	
6.3.1c.(1)	6.3.1(d)(i)	Renumbered, rephrased	

Fire Code 2018	Fire Code 2013	Clause Status	Effective Date
Clause No.	Clause No.		
6.3.1c.(2)	6.3.1(d)(ii)	Renumbered	
6.3.2	6.3.2	---	
6.3.2a.	6.3.2(a)	Renumbered	
6.3.2b.	6.3.2(b)	Renumbered	
6.3.2c.	6.3.2(c)	Renumbered	
6.3.2d.	6.3.2(d)	Renumbered	
6.3.2e.	6.3.2(e)	Renumbered	
6.3.3	6.3.3	---	
6.3.3a.	6.3.3(a)	Renumbered	
6.3.3b.	6.3.3(b)	Renumbered	
6.3.3c.	6.3.3(c)	Renumbered	
6.3.3d.	6.3.3(d)	Renumbered	
6.3.3d.(1)	6.3.3(d)	Renumbered	
6.3.3d.(2)	Nil	New	01.03.2019
6.3.3d.(3)	6.3.3(e)	Renumbered	
6.3.3e.	---	New	01.03.2019
6.3.4	6.3.4	---	
6.3.5	6.3.5	---	
6.3.5a.	6.3.5(a)	Renumbered	
6.3.5a.(1)	6.3.5(a)	Renumbered	
6.3.5a.(2)	6.3.5(c)	Renumbered	
6.3.5b.	6.3.5(b)	Renumbered	
6.3.5c.	6.3.5(d)	Renumbered	
6.3.5c.(1)	6.3.5(d)	Renumbered	
6.3.5c.(1)(a)	6.3.5(d)(i)	Renumbered	
6.3.5c.(1)(b)	Appendix 20 (7.2)	Relocated	
6.3.5c.(1)(c)	6.3.5(d)(i)	Renumbered	
6.3.5c.(2)	Appendix 20 (7.2)	Relocated	
6.3.5c.(3)	Appendix 20 (7.3)	Relocated	
6.3.5c.(3)(a)	Appendix 20 (7.3)	Relocated	
6.3.5c.(3)(b)	Appendix 20 (7.3)	Relocated	
6.3.5c.(3)(c)	Appendix 20 (7.3)	Relocated	
6.3.5c.(3)(d)	Appendix 20 (7.3)	Relocated	
6.3.5c.(3)(e)	Appendix 20 (7.3)	Relocated, revised	01.03.2019
6.3.5c.(3)(f)	Appendix 20 (7.3)	Relocated	
6.3.5c.(3)(g)	Appendix 20 (7.3)	Relocated	
6.3.6	---	Extracted from circular dated 16 Nov 2017	01.06.2018
6.3.7	6.3.6	Renumbered	
6.3.7a.	6.3.6(a)	Renumbered	
6.3.7b.	6.3.6(b)	Renumbered	
6.3.7c.	6.3.6(c)	Renumbered	
6.3.8	6.3.7	Renumbered	
6.3.8a.	6.3.7(a)	Renumbered	
6.3.8b.	6.3.7(b)	Renumbered	
6.3.8c.	6.3.7(c)	Renumbered	
6.3.8d.	6.3.7(d)	Revised, extracted from circular dated 11 Aug 2016	01.11.2016
6.3.9	6.3.8	Renumbered	
6.3.10	---	Extracted from circular dated 15 Dec 2015	16.06.2016
6.3.11	---	New	01.03.2019

Fire Code 2018

Fire Code 2018	Fire Code 2013	Clause Status	Effective Date
Clause No.	Clause No.		
6.4	6.4	---	
6.4.1a.	6.4.1(a)	Renumbered	
6.4.1b.	6.4.1(b)	Renumbered	
6.4.1c.	6.4.1(c)	Revised, extracted from circular dated 11 Aug 2016	01.11.2016
6.4.1c.(1)	6.4.1(c)	Revised, extracted from circular dated 11 Aug 2016	01.11.2016
6.4.1c.(1)(a)	6.4.1(c)	Revised, extracted from circular dated 11 Aug 2016	01.11.2016
6.4.1c.(1)(b)	6.4.1(c)	Revised, extracted from circular dated 11 Aug 2016	01.11.2016
6.4.1c.(2)	6.4.1(c)	Revised, extracted from circular dated 11 Aug 2016	01.11.2016
6.4.1c.(3)	6.4.1(c)	Revised extracted from circular dated 11 Aug 2016	01.11.2016
6.4.1d.	6.4.1(d)	Renumbered	
6.4.1d.(1)	6.4.1(d)(i)	Renumbered	
6.4.1d.(2)	6.4.1(d)(ii)	Renumbered	
6.4.1d.(2)(a)	6.4.1(d)(ii)	Renumbered	
6.4.1d.(2)(b)	6.4.1(d)(iii)	Renumbered	
6.4.1d.(2)(b)(i)	6.4.1(d)(iii)(1)	Renumbered	
6.4.1d.(2)(b)(ii)	6.4.1(d)(iii)(2)	Renumbered	
6.4.1d.(2)(b)(iii)	6.4.1(c)	Renumbered	
6.4.1d.(2)(b)(iv)	6.4.1(d)	Renumbered	
6.4.1e.	6.4.1(e)(iii)	Renumbered	
6.4.1f.	6.4.1(e)	Renumbered, rephrased	
6.4.1f.(1)	6.4.1(e)(i)	Renumbered	
6.4.1f.(1)(a)	6.4.1(e)(i)(1)	Renumbered	
6.4.1f.(1)(b)	6.4.1(e)(i)(2)	Renumbered	
6.4.1f.(1)(c)	6.4.1(e)(i)(3)	Renumbered	
6.4.1f.(2)	6.4.1(e)(ii)	Renumbered	
6.4.1f.(3)	6.4.1(e)(ii)	Renumbered	
6.4.1f.(4)	---	Extracted from circular dated 15 Dec 2015	16.06.2016
6.4.2	6.4.2	---	
6.4.3	6.4.3	---	
6.4.3a.	6.4.3(a)	Renumbered	
6.4.3b.	6.4.3(b)	Renumbered	
6.4.3c.	6.4.3(b)	Renumbered, revised	01.03.2019
6.4.3c.(1)	6.4.3(b)(i)	Renumbered, revised	01.03.2019
6.4.3c.(2)	6.4.3(b)(ii)	Renumbered, revised	01.03.2019
6.4.3c.(3)	6.4.3(b)(iii)	Renumbered, revised	01.03.2019
6.4.3c.(4)	6.4.3(b)(iv)	Renumbered, revised	01.03.2019
6.4.3d.	---	New	01.03.2019
6.4.4	6.4.4	---	
6.4.4a.	6.4.4(a)	Renumbered	
6.4.4b.	6.4.4(b)	Renumbered	
6.4.4c.	6.4.4(c)	Renumbered	
6.4.4c.(1)	6.4.4(c)(i)	Renumbered	
6.4.4c.(2)	6.4.4(c)(ii)	Renumbered	
6.4.4c.(3)	6.4.4(c)(iii)	Renumbered	

Fire Code 2018	Fire Code 2013	Clause Status	Effective Date
Clause No.	Clause No.		
6.4.4c.(4)	6.4.4(c)(iv)	Renumbered	
6.4.4c.(5)	6.4.4(c)(v)	Renumbered	
6.4.5	---	Extracted from circular dated 12 Decc 2013	12.12.2013
6.4.6	6.4.5	---	
6.4.6a.	6.4.5(a)	Renumbered, rephrased	
6.4.6b.	6.4.5(b)	Renumbered	
6.4.6c.	6.4.5(c)	---	
6.4.7	6.4.7 + Appendix 11	Relocated, rephrased	
6.4.8	Appendix 14	Relocated, rephrased	
6.5	6.5	---	
6.5.1	6.5.1	---	
6.5.2	6.5.2	---	
6.6	6.6	---	
6.6.1	6.6.1	---	
6.6.2	6.6.1	Renumbered	
6.6.3	6.6.2	Renumbered	
6.6.3a.	6.6.2(a)	Renumbered	
6.6.3b.	6.6.2(b)	Renumbered	
6.6.3b.(1)	6.6.2(b)	Renumbered	
6.6.3b.(1)(a)	6.6.2(b)(ii)	Renumbered	
6.6.3b.(1)(b)	6.6.2(b)(iv)	Renumbered	
6.6.3b.(1)(c)	6.6.2(b)	Revised	01.03.2019
6.6.3b.(1)(d)	6.6.2(b)(vi)	Renumbered	
6.6.3b.(2)	---	New	01.03.2019
6.6.3b.(2)(a)	---	New	01.03.2019
6.6.3b.(2)(b)	---	New	01.03.2019
6.6.3b.(2)(c)	---	New	01.03.2019
6.6.3c.	6.6.2(c)	Renumbered	
6.6.4	6.6.3	Renumbered	
6.6.4a.	6.6.3	Renumbered	
6.6.4a.(1)	6.6.3(e)	Renumbered	
6.6.4a.(2)	6.6.3(a)	Renumbered	
6.6.4a.(3)	6.6.3(b)	Renumbered, rephrased	
6.6.4a.(4)	6.6.3(d)	Renumbered	
6.6.4a.(5)	---	New	01.03.2019
6.6.4b.	6.6.3(a)	Renumbered	
6.6.4b.(1)	6.6.3(a)	Renumbered	
6.6.4b.(2)	6.6.3(a)	Renumbered, rephrased	
6.6.4b.(3)	6.6.3(a)	Renumbered, rephrased	
6.6.4c.	6.6.3	Renumbered	
6.6.4c.(1)	6.6.3(b)	Renumbered	
6.6.4c.(2)	6.6.3(f)	Renumbered	
6.6.4c.(3)	6.6.3(g)	Renumbered	
6.6.4d.	6.6.3(c)	Renumbered	
6.6.4.d(1)	6.6.3e	Renumbered	
6.6.4.d(2)	---	New	01.03.2019
6.6.5	---	---	

Fire Code 2018

Fire Code 2018	Fire Code 2013	Clause Status	Effective Date
Clause No.	Clause No.		
6.6.5a.	Appendix 20 (1.1) & Appendix 21 (1.1)	Relocated	
6.6.5a.(1)			
6.6.5a.(1)(a)			
6.6.5a.(1)(b)			
6.6.5b.	Appendix 20 (1.1) & Appendix 21 (1.1)	Relocated	
6.6.5b.(1)	Appendix 20 (6.2.1),	Relocated	
6.6.5b.(2)	Appendix 21 (3.1.1.2)	Relocated	
6.6.5b.(3)	Appendix 21 (3.1.1.2)	Relocated	
6.6.5b.(4)	Appendix 1 (3.1.3.1)	Relocated	
6.6.5c.	Appendix 21 (3.1.2)	Relocated	
6.6.5c.(1)	Appendix 21 (3.1.2.1)	Relocated	
6.6.5c.(2)	Appendix 21 (3.1.2.2)	Relocated	
6.6.5c.(3)	Appendix 21 (3.1.2.3)	Relocated	
6.6.5c.(4)	Appendix 21 (3.1.2.4)	Relocated	
6.6.5c.(5)	Appendix 21 (3.1.2.4)	Relocated	
6.6.5c.(5)(a)	Appendix 21 (3.1.2.4)	Relocated	
6.6.5c.(5)(b)	Appendix 21 (3.1.2.4)	Relocated	
6.6.5c.(5)(c)	Appendix 21 (3.1.2.4)	Relocated	
6.6.5c.(5)(d)	Appendix 21 (3.1.2.4)	Relocated	
6.6.5d.	Appendix 20 (6.2.1(g))	Relocated	
6.6.5d.(1)	Appendix 20 (6.2.1(g))	Relocated	
6.6.5d.(2)	Appendix 20 (6.1.1)	Relocated	
6.6.5d.(3)	Appendix 20 (6.2.1(g))	Relocated	
6.6.5e.	Appendix 20 (6.2.1(c))	Relocated	
6.6.5e.(1)	Appendix 20 (6.2.1(c))	Relocated	
6.6.5e.(2)	---	New	01.03.2019
6.6.5f.	Appendix 20 (6.1)	Relocated	
6.6.5f.(1)	Appendix 20 (6.1)	Relocated	
6.6.5f.(2)	---	Extracted from circular dated 25 June 2013	25.06.2013
6.6.5g.	Appendix 21 (3.1)	Relocated	
6.6.5g.(1)	Appendix 21 (3.1)	Relocated	
6.6.5g.(1)(a)	Appendix 21 (3.1.3.2(a))	Relocated, revised	01.03.2019
6.6.5g.(1)(b)	Appendix 21 (3.1.3.2(b))	Relocated	
6.6.5g.(1)(c)	Appendix 21 (3.1.3.3)	Relocated	
6.6.5g.(2)			
6.6.6	6.6.4	Renumbered	
6.6.6a.	6.6.4(a)	Renumbered	
6.6.6a.(1)	6.6.4(a)	Renumbered	
6.6.6a.(2)	---	New	01.03.2019
6.6.6a.(3)	---	New	01.03.2019
6.6.6b.	6.6.4(b)	Renumbered, rephrased	
6.6.6b.(1)	6.6.4(b)	Renumbered, rephrased	
6.6.6b.(2)	6.6.4(b)	Renumbered, rephrased	
6.6.6b.(3)	6.6.4(b)	Renumbered, rephrased	
6.6.6b.(4)	6.6.4(b)	Renumbered, rephrased	
6.6.6c.	6.6.4(c)	Renumbered, rephrased	
6.6.6c.(1)	6.6.4(c)	Revised, extracted from circular dated 8 Nov 2012	08.11.2012

Fire Code 2018	Fire Code 2013	Clause Status	Effective Date
Clause No.	Clause No.		
6.6.6c.(2)	6.6.4(d)(i)	Revised, extracted from circular dated 8 Nov 2012	08.11.2012
6.6.6d.	6.6.4(d)	Renumbered	
6.6.6a.(1)	6.6.4(d)(i)	Renumbered	
6.6.6d.(2)	6.6.4(d)(ii)	Renumbered	
6.6.6d.(3)	6.6.4(d)(iii)	Renumbered	
6.6.6e.	6.6.4(e)	Renumbered	
6.6.6e.(1)	6.6.4(e)(i)	Renumbered, rephrased	
6.6.6e.(2)	6.6.4(e)(i)	Renumbered, rephrased	
6.6.6e.(3)	---	New	01.03.2019
6.6.6e.(3)(a)	---	New	01.03.2019
6.6.6e.(3)(b)	---	New	01.03.2019
6.6.6e.(3)(c)	---	New	01.03.2019
6.6.6e.(3)(d)	---	New	01.03.2019
6.6.6e.(4)	6.6.4(e)(ii)	Renumbered	
6.6.6e.(4)	6.6.4(e)(iii)	Renumbered	
6.6.6e.(4)	6.6.4(e)(iv)	Renumbered	
6.6.7	Appendix 19	Relocated	
6.7	---	New	01.03.2019
6.7.1	---	New	01.03.2019
6.7.2	---	New	01.03.2019
6.8	---	New	01.03.2019
CHAPTER 7			
7.1	7.1	---	
7.1.1	7.1.1(a)	Renumbered	
7.1.2	7.1.1(b)	Renumbered	
7.1.2a.	7.1.1(b)(i)	Renumbered	
7.1.2b.	7.1.1(b)(ii)	Renumbered	
7.1.2c.	7.1.1(b)(iii)	Renumbered	
7.1.2c.(1)	7.1.1(b)(iii)(1)	Renumbered	
7.1.2c.(2)	7.1.1(b)(iii)(2)	Renumbered	
7.1.2c.(3)	7.1.1(b)(iii)(3)	Renumbered	
7.1.2d.	7.1.1(b)(iv)	Renumbered	
7.1.2d.(1)	7.1.1(b)(iv)	Renumbered & rephrased	
7.1.2d.(2)	7.1.1(b)(iv)	Renumbered & rephrased	
7.1.2d.(3)	7.1.1(b)(iv)	Renumbered & rephrased	
7.1.2e.	7.1.1(d)	Renumbered	
7.1.2f.	7.1.1(e)	Renumbered	
7.1.2g.	7.1.1(g)	Renumbered	
7.1.2h.	7.1.1(j)	Renumbered	
7.1.2h.(1)	7.1.1(j)(i)	Renumbered	
7.1.2h.(2)	7.1.1(j)(ii)	Renumbered	
7.1.2h.(3)	7.1.1(j)(iii)	Renumbered	
7.1.2h.(4)	7.1.1(j)(iv)	Renumbered	
7.1.2h.(5)	---	New	01.03.2019
7.1.3	7.1.1(c)	Renumbered	
7.1.3a.	7.1.1(c)(i)	Renumbered	
7.1.3b.	7.1.1(c)(ii)	Renumbered	
7.1.3b.(1)	7.1.1(c)(ii)(1)	Renumbered	
7.1.3b.(2)	7.1.1(c)(ii)(2)	Renumbered	

Fire Code 2018	Fire Code 2013	Clause Status	Effective Date
Clause No.	Clause No.		
7.1.4	7.1.1(f)	Renumbered	
7.1.4a.	7.1.1(f)(i)	Renumbered	
7.1.4a.(1)	7.1.1(f)(i)(1)	Renumbered	
7.1.4a.(2)	7.1.1(f)(i)(2)	Renumbered	
7.1.4a.(3)	7.1.1(f)(i)(3)	Renumbered	
7.1.4a.(4)	7.1.1(f)(i)(4)	Renumbered	
7.1.4a.(5)	7.1.1(f)(i)(5)	Renumbered	
7.1.4a.(6)	7.1.1(f)(i)(6)	Renumbered	
7.1.4b.	7.1.1(f)(ii)	Renumbered	
7.1.4c.	7.1.1(f)(iii)	Renumbered	
7.1.4c.(1)	7.1.1(f)(iii)(1)	Renumbered	
7.1.4c.(2)	7.1.1(f)(iii)(2)	Renumbered	
7.1.5	7.1.1(h)	Renumbered	
7.1.5a.	7.1.1(h)(i)	Renumbered	
7.1.5a.(1)	7.1.1(h)(i)(1)	Renumbered	
7.1.5a.(2)	7.1.1(h)(i)(2)	Renumbered	
7.1.5b.	7.1.1(h)(ii)	Renumbered	
7.1.5b.(1)	7.1.1(h)(ii)(1)	Renumbered	
7.1.5b.(1)(a)	7.1.1(h)(ii)(1)	Renumbered	
7.1.5b.(1)(b)	7.1.1(h)(ii)(1)	Renumbered	
7.1.5b.(2)	7.1.1(h)(ii)(2)	Renumbered	
7.1.5b.(3)	7.1.1(h)(ii)(3)	Renumbered	
7.1.5b.(4)	7.1.1(h)(ii)(4)	Renumbered	
7.1.5b.(5)	7.1.1(h)(ii)(5)	Renumbered	
7.1.5b.(6)	7.1.1(h)(ii)(6)	Renumbered	
7.1.5b.(7)	7.1.1(h)(ii)(7)	Renumbered	
7.1.5b.(7)(a)	7.1.1(h)(ii)(7)	Renumbered	
7.1.5b.(7)(b)	7.1.1(h)(ii)(7)	Renumbered	
7.1.5b.(7)(c)	7.1.1(h)(ii)(7)	Renumbered	
7.1.5b.(8)	7.1.1(h)(ii)(8)	Renumbered	
7.1.5c.	7.1.1(h)(iii)	Renumbered	
7.1.5c.(1)	7.1.1(h)(iii)(1)	Renumbered	
7.1.5c.(2)	7.1.1(h)(iii)(2)	Renumbered	
7.1.5c.(3)	7.1.1(h)(iii)(3)	Renumbered	
7.1.5c.(4)	7.1.1(h)(iii)(4)	Renumbered	
7.1.5c.(5)	7.1.1(h)(iii)(5)	Renumbered	
7.1.5d.	7.1.1(h)(iv)	Renumbered	
7.1.6	7.1.1(i)	Renumbered	
7.1.6a.	7.1.1(i)(1)	Renumbered	
7.1.6b.	7.1.1(i)(2)	Renumbered	
7.1.6b.(1)	7.1.1(i)(2)(1)	Renumbered	
7.1.6b.(2)	7.1.1(i)(2)(2)	Renumbered	
7.1.6b.(3)	7.1.1(i)(2)(3)	Renumbered	
7.1.7	7.1.1(k)	Renumbered	
7.1.7a.	7.1.1(k)	Renumbered, rephrased	
7.1.7b.	7.1.1(k)	Renumbered, rephrased	
7.1.8	7.1.2	Renumbered	
7.1.8a.	7.1.2(a)	Renumbered, rephrased	
7.1.8b.	7.1.2(a)	Renumbered, rephrased	
7.1.8b.(1)	7.1.2(a)	Renumbered, rephrased	

Fire Code 2018	Fire Code 2013	Clause Status	Effective Date
Clause No.	Clause No.		
7.1.8b.(2)	7.1.2(a)	Renumbered, rephrased	
7.1.8c.	7.1.2(b)	Renumbered	
7.1.8c.(1)	7.1.2(b)	Renumbered	
7.1.8c.(1)(a)	7.1.2(b)(i)	Renumbered	
7.1.8c.(1)(b)	7.1.2(b)(ii)	Renumbered	
7.1.8c.(2)	7.1.2(c)	Renumbered	
7.1.8d.	7.1.2(d)	Renumbered	
7.1.9	7.1.3	Renumbered	
7.1.9a.	7.1.3(a)	Renumbered	
7.1.9b.	7.1.3(b)	Renumbered	
7.1.9b.(1)	7.1.3(b)(i)	Renumbered	
7.1.9b.(2)	7.1.3(b)(ii)	Renumbered	
7.1.9b.(3)	7.1.3(b)(iii)	Renumbered	
7.1.9b.(4)	7.1.3(b)(iv)	Renumbered	
7.1.9b.(5)	7.1.3(b)(v)	Renumbered, rephrased	
7.1.9b.(6)	7.1.3(b)(v)	Renumbered, rephrased	
7.1.10	7.1.4	Renumbered	
7.1.10a.	7.1.4(a)	Renumbered	
7.1.10b.	7.1.4(b)	Renumbered	
7.1.10c.	7.1.4(c)	Renumbered	
7.1.10d.	7.1.4(d)	Renumbered, rephrased	
7.1.10e.	7.1.4(d)	Renumbered, rephrased	
7.1.11	7.1.5	Renumbered	
7.1.11a.	7.1.5(a)	Renumbered	
7.1.11b.	7.1.5(b)	Renumbered	
7.1.11c.	7.1.5(c)	Renumbered	
7.1.11d.	7.1.5(d)	Renumbered	
7.1.12	7.1.6	Renumbered	
7.1.12a.	7.1.6(a)	Renumbered	
7.1.12b.	7.1.6(b)	Renumbered	
7.1.12c.	7.1.6(c)	Renumbered	
7.1.12d.	7.1.6(d)	Renumbered	
7.1.13	7.1.7	Renumbered	
7.1.13a.	7.1.7(a)	Renumbered	
7.1.13a.(1)	7.1.7(a)(i)	Renumbered	
7.1.13a.(2)	7.1.7(a)(ii)	Renumbered	
7.1.13a.(3)	7.1.7(a)(iii)	Renumbered	
7.1.13a.(4)	7.1.7(a)(iv)	Renumbered	
7.1.13b.	7.1.7(b)	Renumbered	
7.1.13b.(1)	7.1.7(b)(i)	Renumbered	
7.1.13b.(1)(a)	7.1.7(b)(i)(1)	Renumbered	
7.1.13b.(1)(b)	7.1.7(b)(i)(4)	Renumbered	
7.1.13b.(2)	7.1.7(b)(ii) & (iii)	Renumbered	
7.1.13b.(2)(a)	7.1.7(b)(ii)	Renumbered, revised	01.03.2019
7.1.13b.(2)(b)	7.1.7(b)(ii)(1)	Renumbered, revised	01.03.2019
7.1.13b.(2)(c)	7.1.7(b)(ii)(3)	Renumbered	
7.1.13b.(2)(d)	7.1.7(b)(ii)(6)	Renumbered	
7.1.13b.(2)(e)	7.1.7(b)(ii)(7)	Renumbered	
7.1.13b.(2)(f)	7.1.7(b)(ii)(8)	Renumbered	
7.1.13c.	---	Extracted from circular dated 29 May 2014	01.12.2014

Fire Code 2018

Fire Code 2018	Fire Code 2013	Clause Status	Effective Date
Clause No.	Clause No.		
7.1.13c.(1)	---	Extracted from circular dated 29 May 2014	01.12.2014
7.1.13c.(2)	---	Extracted from circular dated 29 May 2014	01.12.2014
7.1.13c.(3)	---	Extracted from circular dated 29 May 2014	01.12.2014
7.1.13c.(4)	---	Extracted from circular dated 29 May 2014	01.12.2014
7.1.13d.	---	Extracted from circular dated 29 May 2014	01.12.2014
7.1.14	7.1.8	Renumbered	
7.1.14a.	7.1.8(a)	Renumbered	
7.1.14a.(1)	7.1.8(a)(i)	Renumbered	
7.1.14a.(2)	7.1.8(a)(ii)	Renumbered	
7.1.14a.(3)	7.1.8(a)(iii)	Renumbered	
7.1.14a.(4)	7.1.8(a)(iv)	Renumbered	
7.1.14b.	7.1.8(a)	Revised	01.03.2019
7.1.14b.(1)	7.1.8(a)	Revised	01.03.2019
7.1.14b.(2)	7.1.8(a)	Revised	01.03.2019
7.1.14b.(3)	7.1.8(a)	Revised	01.03.2019
7.1.14b.(4)	7.1.8(a)	Revised	01.03.2019
7.1.15	---	New	01.03.2019
7.1.15a.	---	New	01.03.2019
7.1.15b.	---	New	01.03.2019
7.1.15c.	---	New	01.03.2019
7.1.15d.	---	New	01.03.2019
7.1.15e.	---	New	01.03.2019
7.1.15f.	---	New	01.03.2019
7.1.15g.	---	New	01.03.2019
7.2	7.2	---	
7.2.1	7.2.1	---	
7.2.1a.	7.2.1(a)	Renumbered	
7.2.1b.	7.2.1(b)	Renumbered	
7.2.1c.	7.2.1(c)	Renumbered, revised	01.03.2019
7.2.2	7.2.2	---	
7.2.2a.	7.2.2(a)	Renumbered	
7.2.2b.	7.2.2(b)	Renumbered	
7.2.2c.	7.2.2(c)	Renumbered	
7.2.3	7.2.3	---	
7.2.3a.	7.2.3	Renumbered, rephrased	
7.2.3b.	7.2.3	Renumbered, rephrased	
7.2.3c.	7.2.3	Renumbered, rephrased	
7.2.4	7.2.4	---	
7.2.4a.	7.2.4(a)	Renumbered	
7.2.4b.	7.2.4(b)	Renumbered	
7.2.5	7.2.5	---	
7.2.5a.	7.2.5(a)	Renumbered	
7.2.5b.	7.2.5(b)	Renumbered	
7.2.6	7.2.6	---	
7.2.6a.	7.2.6(a)	Renumbered	
7.2.6b.	7.2.6(b)	Renumbered	
7.2.6c.	7.2.6(c)	Renumbered	
7.3	7.3	---	
7.3.1	7.3.1	---	
7.3.1a.	7.3.1	Revised	01.03.2019

Fire Code 2018	Fire Code 2013	Clause Status	Effective Date
Clause No.	Clause No.		
7.3.1b.	7.3.1	Revised	01.03.2019
7.3.1c.	7.3.1	Revised	01.03.2019
7.4	7.5	Renumbered	
7.4.1	7.5.1	Renumbered	
7.4.1a.	7.5.1	Renumbered	
7.4.1a.(1)	7.5.1(a)	Renumbered	
7.4.1a.(2)	7.5.1(ii)	Renumbered	
7.4.1a.(3)	7.4.1(b)	Renumbered	
7.4.1a.(3)(a)	7.4.1(b)(i)	Renumbered	
7.4.1a.(3)(b)	7.4.1(b)(ii)	Renumbered	
7.4.1a.(3)(c)	7.4.1(b)(iii)	Renumbered	
7.4.1a.(3)(d)	7.4.1(b)(iv)	Renumbered	
7.4.1b.	7.4.1(a)	Renumbered & rephrased	
7.4.2	7.4.2	---	
7.4.2a.	7.4.2(a)	Renumbered	
7.4.2b.	7.4.2(b)	Renumbered	
7.4.2c.	7.4.2(c)	Renumbered	
7.4.2d.	7.4.2(d)	Renumbered	
7.4.2e.	7.4.2(e)	Renumbered	
7.4.3	7.4.4	Renumbered	
7.4.3a.	7.1.9	Renumbered & rephrased	
7.4.3b.	7.1.9 & 7.4.4(a)	Renumbered	
7.4.3c.	7.1.9(a) & 7.4.4(b)	Renumbered	
7.4.3d.	7.1.9(b)	Renumbered	
7.4.3e.	7.1.9(c)	Renumbered	
7.4.3f.	7.4.4(e)	Renumbered	
7.4.3g.	7.1.9(e) & 7.4.4(c)	Renumbered	
7.4.3h.	7.1.9(f) & 7.4.4(d)	Renumbered	
7.4.4	Appendix 17	Relocated	
7.4.4a.	Appendix 17 (2.1)	Relocated	
7.4.4b.	Appendix 17 (3.1)	Relocated	
7.4.4b.(1)	Appendix 17 (3.1)	Relocated	
7.4.4b.(2)	Appendix 17 (3.1)	Relocated	
7.4.4c.	Appendix 17 (3.2)	Relocated	
7.4.4c.(1)	Appendix 17 (3.2)	Relocated	
7.4.4c.(2)	Appendix 17 (3.2)	Relocated	
7.4.4d.	Appendix 17 (3.3)	Relocated	
7.4.4d.(1)	Appendix 17 (3.3)	Relocated	
7.4.4d.(1)(a)	Appendix 17 (3.3)	Relocated	
7.4.4d.(1)(b)	Appendix 17 (3.3)	Relocated	
7.4.4d.(1)(c)	Appendix 17 (3.3)	Relocated	
7.4.4d.(2)	Appendix 17 (3.3)	Relocated	
7.4.4d.(3)	Appendix 17 (3.3)	Relocated	
7.4.4d.(4)	Appendix 17 (3.3)	Relocated	
7.4.4d.(5)	Appendix 17 (3.3)	Relocated	
7.4.4d.(5)(a)	Appendix 17 (3.3)	Relocated	
7.4.4d.(5)(b)	Appendix 17 (3.3)	Relocated	
7.4.4d.(5)(c)	Appendix 17 (3.3)	Relocated	
7.4.4d.(5)(d)	Appendix 17 (3.3)	Relocated	
7.4.4d.(5)(e)	Appendix 17 (3.3)	Relocated	

Fire Code 2018	Fire Code 2013	Clause Status	Effective Date
Clause No.	Clause No.		
7.4.4d.(6)	Appendix 17 (3.3)	Relocated	
7.4.4d.(7)	Appendix 17 (3.3)	Relocated	
7.4.4d.(8)	Appendix 17 (3.3)	Relocated	
7.4.4d.(9)	Appendix 17 (3.3)	Relocated	
7.4.4d.(10)	Appendix 17 (3.3)	Relocated	
7.4.4d.(11)	Appendix 17 (3.3)	Relocated	
7.4.4d.(12)	Appendix 17 (3.3)	Relocated	
7.4.4d.(13)	Appendix 17 (3.3)	Relocated	
7.4.4d.(14)	Appendix 17 (3.3)	Relocated	
7.4.4e.	Appendix 17 (3.4)	Relocated	
7.4.4e.(1)	Appendix 17 (3.4)	Relocated	
7.4.4e.(2)	Appendix 17 (3.4)	Relocated	
7.4.4e.(3)	Appendix 17 (3.4)	Relocated	
7.4.4e.(4)	Appendix 17 (3.4)	Relocated	
7.4.4e.(5)	Appendix 17 (3.4)	Relocated	
7.4.4f.	Appendix 17 (3.5)	Relocated	
7.4.4f.(1)	Appendix 17 (3.5)	Relocated	
7.4.4f.(2)	Appendix 17 (3.5)	Relocated	
7.4.4f.(3)	Appendix 17 (3.5)	Relocated	
7.4.4f.(4)	Appendix 17 (3.5)	Relocated	
7.4.4g.	Appendix 17 (3.6)	Relocated	
7.4.4g.(1)	Appendix 17 (3.6)	Relocated	
7.4.4g.(2)	Appendix 17 (3.6)	Relocated	
7.4.4g.(3)	Appendix 17 (3.6)	Relocated	
7.4.4g.(4)	Appendix 17 (3.6)	Relocated	
7.4.4h.	Appendix 17 (3.7)	Relocated	
7.4.5	7.6	Renumbered	
7.4.5a.	7.6.1	Renumbered, rephrased	
7.4.5b.	7.6.2	Renumbered	
7.4.5c.	7.6.3	Renumbered	
7.4.5c.(1)	7.6.3	Renumbered	
7.4.5c.(2)	Appendix 18 (3.1)	Relocated	
7.4.5c.(2)(a)	Appendix 18 (3.1)	Relocated	
7.4.5c.(2)(b)	Appendix 18 (3.2)	Relocated	
7.4.5c.(2)(b)(i)	Appendix 18 (3.2)	Relocated	
7.4.5c.(2)(b)(ii)	Appendix 18 (3.2)	Relocated	
7.4.5c.(2)(b)(iii)	Appendix 18 (3.2)	Relocated	
7.4.5c.(2)(b)(iv)	Appendix 18 (3.2)	Relocated	
7.4.5c.(2)(c)	Appendix 18 (4.1)	Relocated	
7.4.5c.(2)(c)(i)	Appendix 18 (3.2)	Relocated	
7.4.5c.(2)(c)(ii)	Appendix 18 (3.2)	Renumbered	
7.4.5d.	7.6.4	Renumbered	
7.4.5e.	7.6.5	Renumbered	
7.4.5f.	7.6.6	Renumbered	
7.4.5f.(1)	7.6.6	Renumbered	
7.4.5f.(2)	7.6.7	Renumbered	
7.4.5f.(2)(a)	7.6.7(a)	Renumbered	
7.4.5f.(2)(b)	7.6.7(b)	Renumbered	
7.4.5f.(3)	7.6.8	Renumbered	
7.4.5f.(3)(a)	7.6.8(a)	Renumbered	

Fire Code 2018	Fire Code 2013	Clause Status	Effective Date
Clause No.	Clause No.		
7.4.5f.(3)(b)	7.6.8(b)	Renumbered	
7.4.5f.(4)	7.6.10	Renumbered	
7.4.5f.(5)	7.6.11	Renumbered	
7.4.5f.(6)	7.6.14	Renumbered	
7.4.5g.	7.6.9	Renumbered	
7.4.5g.(1)	7.6.9(a)	Renumbered	
7.4.5g.(2)	7.6.9(b)	Renumbered	
7.4.5h.	7.6.12	Renumbered	
7.4.5h.(1)	7.6.12(a)	Renumbered	
7.4.5h.(2)	7.6.12(b)	Renumbered	
7.4.5i.	7.6.13	Renumbered	
7.4.5i.(1)	7.6.13	Renumbered	
7.4.5i.(2)	7.6.13(a)	Renumbered	
7.4.5i.(3)	7.6.13(b)	Renumbered	
7.4.5i.(4)	7.6.13(c)	Renumbered	
7.4.5i.(5)	7.6.13(d)	Renumbered	
7.4.5i.(6)	7.6.13(e)	Renumbered	
7.4.5i.(7)	7.6.13(f)	Renumbered	
7.4.5j.	7.6.15	Renumbered	
7.4.5j.	7.6.16	Renumbered	
7.4.5k.(1)	7.6.16	Renumbered	
7.4.5k.(1)(a)	7.6.16	Renumbered	
7.4.5k.(1)(b)	7.6.17	Renumbered	
7.4.5k.(2)	7.6.18	Renumbered	
7.4.5l.	7.6.19	Renumbered	
7.4.5m.	7.6.20	Renumbered	
7.4.5m.(1)	7.6.20	Renumbered	
7.4.5m.(2)	7.6.21	Renumbered	
7.4.5m.(3)	7.6.22	Renumbered	
7.4.5m.(4)	7.6.23	Renumbered	
7.4.5n.	7.6.24	Renumbered	
7.4.5n.(1)	7.6.24	Revised, extracted from circular dated 17 Apr 2015	17.04.2015
7.4.5n.(2)	7.6.24	Revised, extracted from circular dated 17 Apr 2015	17.04.2015
7.4.5n.(2)(a)	7.6.24	Revised, extracted from circular dated 17 Apr 2015	17.04.2015
7.4.5n.(2)(b)	7.6.24	Revised, extracted from circular dated 17 Apr 2015	17.04.2015
7.4.5n.(2)(c)	7.6.24	Revised, extracted from circular dated 17 Apr 2015	17.04.2015
7.4.5o.	7.6.25	Renumbered	
7.4.5o.(1)	7.6.25	Revised	01.03.2019
7.4.5o.(2)	---	New	01.03.2019
7.4.5o.(3)	---	New	01.03.2019
7.4.5o.(4)	---	New	01.03.2019
7.4.5o.(5)	---	New	01.03.2019
7.4.5p.	7.6.26	Renumbered	
7.4.5q.	7.6.27	Renumbered	
7.4.5q.(1)	7.6.27(a)	Renumbered	

Fire Code 2018	Fire Code 2013	Clause Status	Effective Date
Clause No.	Clause No.		
7.4.5q.(2)	7.6.27(b)	Renumbered	
7.4.5r.	7.6.28	Renumbered	
7.4.5s.	7.6.29	Renumbered	
7.4.5t.	7.6.30	Renumbered	
7.4.5u.	7.6.31	Renumbered	
7.4.5v.	7.6.32	Renumbered	
7.5	---	New	01.03.2019
7.5.1	---	New	01.03.2019
7.5.1a.	---	New	01.03.2019
7.5.1a.(1)	---	New	01.03.2019
7.5.1a.(2)	---	New	01.03.2019
7.5.1a.(3)	---	New	01.03.2019
7.5.1b.	---	New	01.03.2019
7.5.1c.	---	New	01.03.2019
7.5.1d.	---	New	01.03.2019
CHAPTER 8			
8.1	8.1.	---	
8.1.1	8.1.1	---	
8.1.1a.	8.1.1(a)	Renumbered	
8.1.1b.	8.1.1(b)	Renumbered	
8.1.1c.	8.1.1(c)	Renumbered	
8.1.2	8.1.2	---	
8.1.2a.	8.1.2(a)	Renumbered	
8.1.2b.	8.1.2(b)	Renumbered	
8.1.3	8.1.3	---	
8.1.3a.	8.1.3(a)	Renumbered	
8.1.3a.(1)	8.1.3(a)(i)	Renumbered	
8.1.3a.(2)	8.1.3(a)(ii)	Renumbered	
8.1.3b.	---	New	01.03.2019
8.1.3b.(1)	---	New	01.03.2019
8.1.3b.(2)	---	New	01.03.2019
8.1.3c.	8.1.3(b)	Renumbered	
8.1.3c.(1)	8.1.3(b)(i)	Renumbered	
8.1.3c.(2)	8.1.3(b)(ii)	Renumbered	
8.1.3c.(3)	8.1.3(b)(iii)	Renumbered	
8.1.3c.(4)	8.1.3(b)(iv)	Renumbered	
8.1.3c.(5)	8.1.3(b)(v)	Renumbered	
8.1.3c.(6)	8.1.3(b)(vi)	Renumbered	
8.1.3d.	8.1.3(c)	Renumbered	
8.1.3e.	8.1.3(d)	Renumbered	
8.1.4	8.1.4	---	
8.1.4a.	8.1.4(a)	Renumbered	
8.1.4b.	8.1.4(b)	Renumbered	
8.1.4c.	8.1.4(c)	Renumbered	
8.1.5	8.1.5	---	
8.1.5a.	8.1.5(a)	Renumbered	
8.1.5b.	8.1.5(b)	Renumbered	
8.1.5c.	8.1.5(c)	Renumbered	
8.1.6	8.1.6	---	
8.1.7	8.1.7	---	

Fire Code 2018	Fire Code 2013	Clause Status	Effective Date
Clause No.	Clause No.		
8.1.7a.	8.1.7	Renumbered	
8.1.7a.(1)	8.1.7(a)	Renumbered, rephrased	
8.1.7a.(2)	8.1.7(a)	Renumbered, rephrased	
8.1.7a.(3)	8.1.7(a)	Renumbered, rephrased	
8.1.7a.(3)(a)	Appendix 24	Relocated	
8.1.7a.(3)(b)	Appendix 24	Relocated	
8.1.7a.(3)(b)(i)	Appendix 24	Relocated	
8.1.7a.(3)(b)(ii)	Appendix 24	Relocated	
8.1.7a.(3)(c)	Appendix 24	Relocated	
8.1.7a.(3)(c)(i)	Appendix 24	Relocated	
8.1.7a.(3)(c)(ii)	Appendix 24	Relocated	
8.1.7a.(3)(c)(iii)	Appendix 24	Relocated	
8.1.7a.(3)(d)	---	New	01.03.2019
8.1.7b.	8.1.7(b)	Renumbered	
8.1.7b.(1)	8.1.7(b)	Renumbered	
8.1.7b.(2)	Appendix 24	Relocated	
8.1.7b.(3)	8.1.7(a)	Renumbered	
8.1.7b.(3)(a)	8.1.7(a)	Renumbered	
8.1.7b.(3)(b)	Appendix 24	Relocated	
8.1.7b.(3)(c)	Appendix 24	Relocated	
8.1.7c.	8.1.7(c)	Renumbered	
8.1.7d.	8.1.7(d)	Renumbered	
8.1.7d.(1)	8.1.7(d)	Renumbered	
8.1.7d.(2)	8.1.7(g)	Renumbered	
8.1.7e.	8.1.7(e)	Renumbered	
8.1.7f.	8.1.7(f)	Renumbered	
8.1.8	2.10.3	Renumbered	
8.1.8a.	2.10.3	Renumbered	
8.1.8a.(1)	2.10.3(a)	Renumbered	
8.1.8a.(2)	2.10.3(b)	Renumbered	
8.1.8a.(3)	2.10.3(c)	Renumbered	
8.1.8b.	2.10.4	Renumbered	
8.1.8c.	2.10.3	Renumbered	
8.1.8c.(1)	2.10.3(c)(i)	Renumbered	
8.1.8c.(2)	2.10.3(c)(ii)	Renumbered	
8.1.8c.(3)	2.10.3(c)(iii)	Renumbered	
8.2	8.2	---	
8.2.1	8.2.1(a)	Renumbered	
8.2.1a.	8.2.1(a)(i)	Revised	01.03.2019
8.2.1b.	8.2.1(a)(ii)	Renumbered	
8.2.1c.	8.2.1(c)	Renumbered	
8.2.1c.(1)	8.2.1(c)(i)	Revised	01.03.2019
8.2.1c.(2)	8.2.1(c)(ii)	Renumbered	
8.2.1d.	8.2.1(a)(iii)	Renumbered	
8.2.2	8.2.1(b)	Renumbered	
8.2.2a.	8.2.1(b)	Renumbered	
8.2.2a.(1)	8.2.1(b)(i)	Renumbered, rephrased	
8.2.2a.(2)	8.2.4	Renumbered, rephrased	
8.2.2a.(2)(a)	8.2.4	Renumbered	
8.2.2a.(2)(b)	8.2.4	Renumbered	

Fire Code 2018	Fire Code 2013	Clause Status	Effective Date
Clause No.	Clause No.		
8.2.2b.	8.2.1(b)	Renumbered	
8.2.2b.(1)	8.2.1(b)(i)	Renumbered	
8.2.2b.(2)	8.2.1(b)(ii)	Renumbered	
8.2.2b.(3)	8.2.1(b)(iii)	Renumbered	
8.2.2b.(4)	8.2.1(b)(iv)	Renumbered	
8.2.2b.(5)	8.2.1(b)(v)	Renumbered	
8.2.2b.(6)	8.2.1(b)(vi)	Renumbered	
8.2.2b.(7)	8.2.1(b)(vii)	Renumbered	
8.2.3	8.2.2	Renumbered	
8.2.4	8.2.3	Renumbered	
8.2.4a.	8.2.3(a)	Renumbered	
8.2.4a.(1)	8.2.3(a)(i)	Renumbered	
8.2.4a.(2)	8.2.3(a)(ii)	Renumbered	
8.2.4a.(3)	8.2.3(a)(iii)	Renumbered	
8.2.4b.	8.2.3(b)	Renumbered	
8.2.4c.	8.2.3(c)	Renumbered	
8.2.4c.(1)	8.2.3(c)(i)	Renumbered	
8.2.4c.(1)(a)	8.2.3(c)(i)(1)	Revised	01.03.2019
8.2.4c.(1)(b)	8.2.3(c)(i)(2)	Revised	01.03.2019
8.2.4c.(1)(c)	8.2.3(c)(i)(3)	Renumbered & rephrased	
8.2.4c.(2)	8.2.3(c)(ii)	Renumbered & rephrased	
8.2.4d.	8.2.3(d)	Renumbered	
8.2.4e.	8.2.3(e)	Renumbered	
CHAPTER 9			
9.1	2.4	Renumbered	
9.1.1	---	---	
9.1.1a.	---	---	
9.1.1a.(1)	3.2.4(c)	Renumbered	
9.1.1a.(2)	3.2.5(c)(i)	Renumbered, revised	
9.1.1a.(3)	2.4.1	Renumbered	
9.1.1b.	---	---	
9.1.1b.(1)	2.4.12	Renumbered	
9.1.1b.(2)	3.2.5(c)(i)	Renumbered, revised	
9.2	2.4	Renumbered	
9.2.1	---	---	
9.2.1a.	---	---	
9.2.1a.(1)	2.4.2	Renumbered	
9.2.1a.(2)	2.4.3	Renumbered	
9.2.1a.(3)	2.4.4	Renumbered	
9.2.1a.(4)	2.4.5	Renumbered	
9.2.1a.(4)(a)	2.4.5(a)	Renumbered	
9.2.1a.(4)(b)	2.4.5(b)	Renumbered	
9.2.1a.(4)(c)	2.4.5(c)	Renumbered	
9.2.1a.(4)(d)	2.4.5(d)	Renumbered	
9.2.1a.(4)(e)	2.4.5(f)	Renumbered	
9.2.1a.(4)(e)(i)	2.4.5(f)	Renumbered, rephrased	
9.2.1a.(4)(e)(ii)	2.4.5(f)	Renumbered, rephrased	
9.2.1a.(4)(f)	2.4.5(f)	Renumbered, rephrased	
9.2.1a.(5)	2.4.6	Renumbered	
9.2.1a.(5)(a)	2.4.6(a)	Renumbered	

Fire Code 2018	Fire Code 2013	Clause Status	Effective Date
Clause No.	Clause No.		
9.2.1a.(5)(b)	2.4.6(b)	Renumbered	
9.2.1a.(5)(b)(i)	2.4.6(b)(i)	Renumbered	
9.2.1a.(5)(b)(ii)	2.4.6(b)(ii)	Renumbered	
9.2.1a.(5)(c)	2.4.6(c)	Renumbered	
9.2.1a.(6)	2.4.7	Renumbered, rephrased	
9.2.1a.(7)	2.4.8	Renumbered	
9.2.1a.(8)	2.4.9	Renumbered	
9.2.1a.(8)(a)	2.4.9(a)	Renumbered	
9.2.1a.(8)(b)	2.4.9(b)	Renumbered	
9.2.1a.(9)	2.4.10	Renumbered	
9.2.1a.(9)(a)	2.4.10(a)	Renumbered	
9.2.1a.(9)(b)	2.4.10(b)	Renumbered	
9.2.1a.(10)	2.3.3(f)	Renumbered	
9.2.1a.(10)(a)	2.3.3(f)	Renumbered, revised	
9.2.1a.(10)(b)	2.4.13	Renumbered, rephrased	
9.2.1a.(10)(b)(i)	2.4.13	Renumbered, rephrased	
9.2.1a.(10)(b)(ii)	2.4.13	Renumbered, rephrased	
9.2.1b.	---	---	
9.2.1b.(1)	3.5.5	Renumbered	
9.2.1b.(1)(a)	3.5.5	Renumbered, rephrased	
9.2.1b.(1)(b)	3.3.5	Renumbered	
9.2.1b.(1)(b)(i)	3.3.5(a)	Renumbered	
9.2.1b.(1)(b)(ii)	3.3.5(b)	Renumbered	
9.2.1b.(2)	2.4.12	Renumbered	
9.2.2	Appendix 8	Renumbered	
9.2.2a.	Appendix 8 (B1.)	Relocated	
9.2.2a.(1)	Appendix 8 (B2.a.)	Relocated	
9.2.2a.(2)	Appendix 8 (B2.b.)	Relocated	
9.2.2a.(3)	Appendix 8 (B2.c)	Relocated	
9.2.2a.(4)	Appendix 8 (B2.d.)	Relocated	
9.2.2a.(5)	Appendix 8 (B2.e.)	Relocated	
9.2.2a.(6)	Appendix 8 (B2.f.)	Relocated	
9.2.2a.(7)	Appendix 8 (B2.g.)	Relocated	
9.2.2a.(8)	Appendix 8 (B2.h.)	Relocated	
9.2.2a.(9)	Appendix 8 (B2.i.)	Relocated	
9.2.2a.(10)	Appendix 8 (B2.j.)	Relocated	
9.2.2a.(11)	Appendix 8 (B2.k.)	Relocated	
9.2.2a.(12)	Appendix 8 (B2.l)	Relocated	
9.2.2b.	Appendix 8 (C.)	Relocated	
9.2.2b.(1)	Appendix 8 (C.1.)	Relocated	
9.2.2b.(2)	Appendix 8 (C.3)	Relocated	
9.2.2b.(2)(a)	Appendix 8 (C.2)	Renumbered, revised	01.03.2019
9.2.2b.(2)(b)	Appendix 8 (C.2)	Renumbered, revised	01.03.2019
9.2.2b.(2)(c)	Appendix 8 (C.2.)	Renumbered, revised	01.03.2019
9.2.2b.(3)	Appendix 8 (C.4.)	Renumbered	
9.3	---	---	
9.3.1	---	---	
9.3.2	2.5	Renumbered	
9.3.2a.	---	---	
9.3.2a.(1)	Nil	New	01.03.2019

Fire Code 2018	Fire Code 2013	Clause Status	Effective Date
Clause No.	Clause No.		
9.3.2a.(2)	Nil	New	01.03.2019
9.3.2a.(3)	Nil	New	01.03.2019
9.3.2b.	2.5.1(a)	Renumbered	
9.3.2b.(1)	2.5.1(a)(i)	Renumbered	
9.3.2b.(2)	Table 2.2A	Renumbered	
9.3.2b.(3)	2.5.1(a)(ii)	Renumbered	
9.3.2b.(4)	2.5.1(a)(iii)	Renumbered	
9.3.2b.(4)(a)	2.2.15(b)	Renumbered, rephrased	
9.3.2b.(4)(a)(i)	2.2.15(b)	Renumbered, rephrased	
9.3.2b.(4)(a)(ii)	---	New	01.03.2019
9.3.2b.(4)(b)	---	New	01.03.2019
9.3.2b.(4)(b)(i)	---	New	01.03.2019
9.3.2b.(4)(b)(ii)	---	New	01.03.2019
9.3.2b.(4)(b)(iii)	---	New	01.03.2019
9.3.2b.(5)	2.5.1(a)(iv)	Renumbered	
9.3.2b.(5)(a)	2.5.1(a)(iv)(1)	Renumbered	
9.3.2b.(5)(b)	2.5.1(a)(iv)(2)	Renumbered, revised	01.03.2019
9.3.2b.(5)(c)	---	New	01.03.2019
9.3.2b.(6)	2.5.1(a)(v)	Renumbered	
9.3.2b.(6)(a)	2.5.1(a)(v)(1)	Renumbered, revised	01.03.2019
9.3.2b.(6)(b)	2.5.1(a)(v)(2)	Renumbered, rephrased	
9.3.2b.(6)(c)	2.5.1(a)(v)(3)	Renumbered	
9.3.2b.(6)(d)	2.5.1(a)(v)(4)	Renumbered, rephrased	
9.3.2b.(6)(e)	2.5.1(a)(v)(5)	Renumbered, rephrased	
9.3.2b.(6)(f)	2.5.1(a)(v)(6)	Renumbered, rephrased	
9.3.2b.(6)(g)	2.5.1(a)(v)(7)	Renumbered, rephrased	
9.3.2b.(6)(g)(i)	2.5.1(a)(v)(7)	Renumbered, rephrased	
9.3.2b.(6)(g)(ii)	2.5.1(a)(v)(7)	Renumbered, rephrased	
9.3.2b.(6)(g)(iii)	2.5.1(a)(v)(7)	Renumbered	
9.3.2b.(6)(g)(iv)	2.5.1(a)(v)(7)	Renumbered, rephrased	
9.3.2b.(7)	2.5.1(a)(vi)	Renumbered	
9.3.2b.(7)(a)	2.5.1(a)(vi)(1)	Renumbered	
9.3.2b.(7)(b)	2.5.1(a)(vi)(2)	Renumbered	
9.3.2b.(7)(c)	2.5.1(a)(vi)(3)	Renumbered	
9.3.2b.(7)(d)	2.5.1(a)(vi)(4)	Renumbered	
9.3.2b.(7)(e)	2.5.1(a)(vi)(5)	Renumbered	
9.3.2b.(7)(f)	2.5.1(a)(vi)(6)	Renumbered	
9.3.2b.(7)(g)	2.5.1(a)(vi)(7)	Renumbered	
9.3.2b.(7)(h)	2.5.1(a)(vi)(8)	Renumbered	
9.3.2b.(8)	2.5.1(a)(vii)	Renumbered, rephrased	
9.3.2b.(9)	2.5.1(a)(viii)	Renumbered	
9.3.2b.(9)(a)	2.5.1(a)(viii)(1)	Renumbered, rephrased	
9.3.2b.(9)(b)	2.5.1(a)(viii)(3)	Renumbered	
9.3.2b.(10)	2.5.1(a)(ix)	Renumbered	
9.3.2b.(10)(a)	2.5.1(a)(ix)(1)	Renumbered	
9.3.2b.(10)(b)	2.5.1(a)(ix)(2)	Renumbered	
9.3.2c.	2.5.1(b)	Renumbered	
9.3.2d.	2.5.1(c)	Renumbered	
9.3.2d.(1)	2.5.1(c)(i)	Renumbered, rephrased	
9.3.2d.(2)	2.5.1(c)(i)	Renumbered, rephrased	

Fire Code 2018	Fire Code 2013	Clause Status	Effective Date
Clause No.	Clause No.		
9.3.2d.(3)	2.5.1(c)(i)	Renumbered, rephrased	
9.3.2d.(4)	2.5.1(c)(i)	Renumbered, rephrased	
9.3.2d.(5)	2.5.1(c)(ii)	Renumbered	
9.3.2d.(6)	2.5.1(c)(ii)	Renumbered	
9.3.2e.	2.5.1(d)	Renumbered, rephrased	
9.3.2f.	2.5.1(e)	Renumbered	
9.3.2f.(1)	2.5.1(e)(iii)	Renumbered, rephrased	
9.3.2f.(2)	2.5.1(e)(iii)	Renumbered, rephrased	
9.3.2f.(3)	2.5.1(e)(iv)	Renumbered	
9.3.2g.	2.5.1(f)	Revised	01.03.2019
9.3.3	2.9	Renumbered	
9.3.3a.	2.9.2(a)	Renumbered	
9.3.3b.	2.9.2(b)	Revised	
9.3.3c.	2.9.2(c)	Renumbered	
9.3.3d.	2.9.2(d)	Renumbered	
9.3.3e.	2.9.3	Renumbered	
9.3.3e.(1)	2.9.3(a)	Renumbered	
9.3.3e.(2)	2.9.3(b)	Renumbered	
9.3.3e.(3)	2.9.3(c)	Renumbered, rephrased	
9.3.3e.(3)(a)	2.9.3(c) & (d)	Renumbered, rephrased	
9.3.3e.(3)(b)	2.9.3(c)	Renumbered, rephrased	
9.3.3e.(4)	2.9.3(d)	Revised	01.03.2019
9.3.3e.(5)	2.9.3(e)	Renumbered	
9.3.3e.(6)	2.9.3(f)	Renumbered	
9.3.3e.(7)	2.9.3(g)	Renumbered	
9.3.3f.	2.9.4	Renumbered, rephrased	
9.3.3g.	2.9.5	Renumbered	
9.3.3h.	3.2.5(j)	Renumbered	
9.3.3h.(1)	3.2.5(j)(i)	Renumbered	
9.3.3h.(2)	3.2.5(j)(ii)	Renumbered	
9.3.3h.(3)	3.2.5(j)(iii)	Renumbered	
9.3.4	Appendix 16	Relocated	
9.3.4a.	---	Relocated	
9.3.4a.(1)	Appendix 16 (2.2)	Relocated	
9.3.4a.(2)	Appendix 16 (2.3)	Relocated	
9.3.4a.(3)	Appendix 16 (4.2.7)	Relocated	
9.3.4b.	---	---	
9.3.4b.(1)	Appendix 16 (4.3.1)	Relocated	
9.3.4b.(2)	Appendix 16 (4.3.2)	Relocated	
9.3.4c.	---	---	
9.3.4c.(1)	Appendix 16 (4.2.5)	Relocated	
9.3.4c.(2)	Appendix 16 (4.2.6)	Relocated	
9.3.4d.	Appendix 16 (5.2)	Relocated	
9.3.4d.(1)	Appendix 16 (5.2.1)	Relocated	
9.3.4d.(2)	Appendix 16 (5.3.2)	Relocated	
9.3.4d.(3)	Appendix 16 (5.3.3)	Relocated	
9.3.4e.	Appendix 16 (6.3)	Relocated	
9.3.4f.	Appendix 16 (5.1)	Relocated	
9.3.4f.(1)	Appendix 16 (5.1.1)	Relocated	
9.3.4f.(2)	Appendix 16 (5.5.1)	Relocated	

Fire Code 2018	Fire Code 2013	Clause Status	Effective Date
Clause No.	Clause No.		
9.3.4f.(2)(a)	Appendix 16 (5.5.2)	Relocated	
9.3.4f.(2)(a)(i)	Appendix 16 (5.5.2(i))	Relocated	
9.3.4f.(2)(a)(ii)	Appendix 16 (5.5.2(ii))	Relocated	
9.3.4f.(2)(a)(iii)	Appendix 16 (5.5.2(iii))	Renumbered, revised	01.03.2019
9.3.4f.(2)(a)(iv)	Appendix 16 (5.5.3)	Relocated	
9.3.4f.(2)(b)	Appendix 16 (5.7)	Relocated	
9.3.4f.(3)	Appendix 16 (5.5.4)	Relocated	
9.3.4f.(4)	Appendix 16 (5.5.5)	Relocated	
9.3.4f.(5)	Appendix 16 (5.5.6)	Relocated	
9.3.4g.	Appendix 16 (5.6.1)	Relocated	
9.3.4h.	Appendix 16 (7.1)	Relocated	
9.4	---	---	
9.4.1	---	---	
9.4.1a.	---	---	
9.4.1a.(1)	2.6.1	Renumbered, rephrased	
9.4.1a.(1)(a)	2.6.1(d)	Renumbered, rephrased	
9.4.1a.(1)(b)	2.6.1	Renumbered, rephrased	
9.4.1a.(1)(c)	2.6.1(c)	Revised	01.03.2019
9.4.1a.(2)	---	New	01.03.2019
9.4.1a.(2)(a)	---	New	01.03.2019
9.4.1a.(2)(b)	---	New	01.03.2019
9.4.1a.(2)(c)	---	New	01.03.2019
9.4.1a.(2)(d)	---	New	01.03.2019
9.4.1b.	---	---	
9.5	---	---	
9.5.1	---	---	
9.5.1a.(1)	2.6.1	Renumbered	
9.5.1a.(1)(a)	2.6.1(d)	Renumbered	
9.5.1a.(1)(b)	2.6.1	Renumbered	
9.5.1a.(1)(c)	2.6.1(c)	Renumbered	
9.5.1a.(2)	---	New	01.03.2019
9.5.1a.(2)(a)	---	New	01.03.2019
9.5.1a.(2)(b)	---	New	01.03.2019
9.5.1a.(2)(c)	---	New	01.03.2019
9.5.1a.(2)(d)	---	New	01.03.2019
9.5.1b.	---	New	01.03.2019
9.5.2	---	Extracted from circular dated 30 Oct 2015	30.04.2016
9.5.2a.	---	Extracted from circular dated 30 Oct 2015	30.04.2016
9.5.2a.(1)	---	Extracted from circular dated 30 Oct 2015	30.04.2016
9.5.2a.(1)(a)	---	Extracted from circular dated 30 Oct 2015	30.04.2016
9.5.2a.(1)(b)	---	Extracted from circular dated 30 Oct 2015	30.04.2016
9.5.2a.(1)(c)	---	Extracted from circular dated 30 Oct 2015	30.04.2016
9.5.2a.(1)(d)	---	Extracted from circular dated 30 Oct 2015	30.04.2016
9.5.2b.	---	Extracted from circular dated 30 Oct 2015	30.04.2016
9.5.2b.(1)	---	Extracted from circular dated 30 Oct 2015	30.04.2016
9.5.2b.(1)(a)	---	Extracted from circular dated 30 Oct 2015	30.04.2016
9.5.2b.(1)(b)	---	Extracted from circular dated 30 Oct 2015	30.04.2016
9.5.2b.(2)	---	Extracted from circular dated 30 Oct 2015	30.04.2016
9.5.2b.(2)(a)	---	Extracted from circular dated 30 Oct 2015	30.04.2016
9.5.2b.(2)(b)	---	Extracted from circular dated 30 Oct 2015	30.04.2016

Fire Code 2018	Fire Code 2013	Clause Status	Effective Date
Clause No.	Clause No.		
9.5.2b.(2)(c)	---	Extracted from circular dated 30 Oct 2015	30.04.2016
9.5.2b.(3)	---	Extracted from circular dated 30 Oct 2015	30.04.2016
9.5.2b.(3)(a)	---	Extracted from circular dated 30 Oct 2015	30.04.2016
9.5.2b.(3)(b)	---	Extracted from circular dated 30 Oct 2015	30.04.2016
9.5.2b.(3)(c)	---	Extracted from circular dated 30 Oct 2015	30.04.2016
9.5.2b.(3)(d)	---	Extracted from circular dated 30 Oct 2015	30.04.2016
9.5.2b.(3)(e)	---	Extracted from circular dated 30 Oct 2015	30.04.2016
9.5.2b.(3)(f)	---	Extracted from circular dated 30 Oct 2015	30.04.2016
9.5.2b.(4)	---	Extracted from circular dated 30 Oct 2015	30.04.2016
9.5.2b.(4)(a)	---	Extracted from circular dated 30 Oct 2015	30.04.2016
9.5.2b.(4)(b)	---	Extracted from circular dated 30 Oct 2015	30.04.2016
9.5.2b.(4)(c)	---	Extracted from circular dated 30 Oct 2015	30.04.2016
9.5.2b.(4)(d)	---	Extracted from circular dated 30 Oct 2015	30.04.2016
9.5.2b.(4)(e)	---	Extracted from circular dated 30 Oct 2015	30.04.2016
9.5.2b.(4)(f)	---	Extracted from circular dated 30 Oct 2015	30.04.2016
9.5.2b.(4)(g)	---	Extracted from circular dated 30 Oct 2015	30.04.2016
9.5.2b.(4)(h)	---	Extracted from circular dated 30 Oct 2015	30.04.2016
9.5.2b.(5)	---	Extracted from circular dated 30 Oct 2015	30.04.2016
9.5.2b.(5)(a)	---	Extracted from circular dated 30 Oct 2015	30.04.2016
9.5.2b.(5)(b)	---	Extracted from circular dated 30 Oct 2015	30.04.2016
9.5.2b.(5)(c)	---	Extracted from circular dated 30 Oct 2015	30.04.2016
9.6	---	---	
9.6.1	---	---	
9.6.1a.	---	---	
9.6.1a.(1)	2.6.1	Renumbered	
9.6.1a.(1)(a)	2.6.1(d)	Renumbered	
9.6.1a.(1)(b)	2.6.1	Renumbered	
9.6.1a.(1)(c)	2.6.1(c)	Revised	01.03.2019
9.6.1a.(2)	2.6.2	Renumbered	
9.6.1a.(2)(a)	2.6.2(d)	Revised	01.03.2019
9.6.1a.(2)(b)	2.6.2(b)	Revised	01.03.2019
9.6.1a.(2)(c)	2.6.2(c)	Renumbered	
9.6.1a.(2)(d)	2.6.2(b)	Renumbered, rephrased	
9.6.1a.(2)(e)	2.6.2(e)	Renumbered	
9.6.1a.(2)(f)	2.6.2(f)	Renumbered	
9.6.1b.	3.2.5(p)	Renumbered	
9.6.2	Appendix 10	Relocated	
9.6.2a.(1)	Appendix 10 (1.1)	Relocated	
9.6.2a.(2)	Appendix 10 (1.3)	Relocated	
9.6.2a.(3)	Appendix 10 (1.4)	Relocated	
9.6.2a.(4)	Appendix 10 (1.5)	Relocated	
9.6.2a.(5)	Appendix 10 (1.6)	Relocated	
9.6.2b.	Appendix 10 (2)	Relocated	
9.6.2b.(1)	Appendix 10 (2.1)	Relocated	
9.6.2b.(2)	Appendix 10 (2.2)	Relocated	
9.6.2c.	Appendix 10 (2.3)	Relocated	
9.6.2c.(1)	Appendix 10 (2.3(i))	Relocated	
9.6.2c.(2)	Appendix 10 (2.3(ii))	Relocated	
9.6.2c.(3)	Appendix 10 (2.3(iii))	Relocated	
9.6.2c.(4)	Appendix 10 (2.3(iv))	Relocated	

Fire Code 2018	Fire Code 2013	Clause Status	Effective Date
Clause No.	Clause No.		
9.6.2c.(5)	Appendix 10 (2.3)	Relocated	
9.6.2d.	Appendix 10 (2.4)	Relocated	
9.6.2d.(1)	Appendix 10 (2.4(a))	Relocated	
9.6.2d.(2)	Appendix 10 (2.4(b))	Relocated	
9.6.2d.(3)	Appendix 10 (2.4(c))	Relocated	
9.6.2e.	Appendix 10 (2.5)	Relocated	
9.6.2f.	Appendix 10 (2.6)	Relocated	
9.6.2f.(1)	Appendix 10 (2.6(a))	Relocated	
9.6.2f.(2)	Appendix 10 (2.6(b))	Relocated	
9.6.2f.(3)	Appendix 10 (2.6(c))	Relocated	
9.6.2g.	Appendix 10 (2.7)	Relocated	
9.6.2h.	Appendix 10 (2.8)	Relocated	
9.6.2i.	Appendix 10 (2.9)	Relocated	
9.6.2i.(1)	Appendix 10 (2.9(a))	Relocated	
9.6.2i.(2)	Appendix 10 (2.9(b))	Relocated	
9.6.2i.(3)	Appendix 10 (2.9(c))	Relocated	
9.6.2i.(3)(a)	Appendix 10 (2.9(c)(i))	Relocated	
9.6.2i.(3)(b)	Appendix 10 (2.9(c)(ii))	Relocated	
9.6.2i.(3)(c)	Appendix 10 (2.9(c)(iii))	Relocated	
9.6.2i.(3)(d)	Appendix 10 (2.9(d))	Relocated	
9.6.2i.(3)(e)	Appendix 10 (2.9(e))	Relocated	
9.6.2i.(3)(f)	Appendix 10 (2.9(f))	Relocated	
9.6.2j.	Appendix 10 (2.10)	Relocated	
9.6.2j.(1)	Appendix 10 (2.10(a))	Relocated	
9.6.2j.(2)	Appendix 10 (2.10(b))	Relocated	
9.6.2j.(3)	Appendix 10 (2.10(c))	Relocated	
9.6.2k.	Appendix 10 (2.11)	Relocated	
9.6.2k.(1)	Appendix 10 (2.11(a))	Relocated	
9.6.2k.(2)	Appendix 10 (2.11(b))	Relocated	
9.6.2l.	Appendix 10 (2.12)	Relocated	
9.6.2m.	Appendix 10 (2.13)	Relocated	
9.6.2m.(1)	Appendix 10 (2.13(a))	Relocated	
9.6.2m.(2)	Appendix 10 (2.13(b))	Relocated	
9.6.2m.(3)	Appendix 10 (2.13(c))	Relocated	
9.6.2m.(4)	Appendix 10 (2.13(d))	Relocated	
9.6.2m.(5)	Appendix 10 (2.13(e))	Relocated	
9.6.2n.	Appendix 10 (2.14)	Relocated	
9.6.2o.	Appendix 10 (2.15)	Relocated	
9.6.2o.(1)	Appendix 10 (2.15(a))	Relocated	
9.6.2o.(2)	Appendix 10 (2.15(b))	Relocated	
9.6.2o.(3)	Appendix 10 (2.15(c))	Relocated	
9.6.2p.	Appendix 10 (2.16)	Relocated	
9.6.2p.(1)	Appendix 10 (2.16(a))	Relocated	
9.6.2p.(2)	Appendix 10 (2.16(b))	Relocated	
9.6.2q.	Appendix 10 (2.17)	Relocated	
9.6.2q.(1)	Appendix 10 (2.17(a))	Relocated	
9.6.2q.(2)	Appendix 10 (2.17(b))	Relocated	
9.6.2q.(3)	Appendix 10 (2.17(c))	Relocated	
9.6.2q.(4)	Appendix 10 (2.17(d))	Relocated	
9.6.2q.(5)	Appendix 10 (2.17(e))	Relocated	

Fire Code 2018	Fire Code 2013	Clause Status	Effective Date
Clause No.	Clause No.		
9.6.2q.(6)	Appendix 10 (2.17(f))	Relocated	
9.6.2r.	Appendix 10 (2.18)	Relocated	
9.6.2s.	Appendix 10 (3)	Relocated	
9.6.2s.(1)	Appendix 10 (3.1)	Relocated	
9.6.2s.(2)	Appendix 10 (3.2)	Relocated	
9.6.2s.(3)	Appendix 10 (3.3)	Relocated	
9.6.2s.(4)	Appendix 10 (3.4)	Relocated	
9.6.2s.(5)	Appendix 10 (3.5)	Relocated	
9.6.2s.(6)	Appendix 10 (3.6)	Relocated	
9.6.2s.(7)	Appendix 10 (3.7)	Relocated	
9.6.2s.(8)	Appendix 10 (3.8)	Relocated	
9.6.2s.(9)	Appendix 10 (3.9)	Relocated	
9.6.2t.	Appendix 10 (4)	Relocated	
9.6.2t.(1)	Appendix 10 (4.2)	Relocated	
9.6.2t.(2)	Appendix 10 (4.3)	Relocated	
9.6.2t.(3)	Appendix 10 (4.4)	Relocated	
9.6.2u.	Appendix 10 (5)	Relocated	
9.6.2u.(1)	Appendix 10 (5.3)	Relocated	
9.6.2u.(2)	Appendix 10 (5.1)	Relocated	
9.6.2u.(3)	Appendix 10 (5.6)	Relocated	
9.6.2u.(4)	Appendix 10 (5.7)	Relocated	
9.6.2u.(5)	Appendix 10 (5.8)	Relocated	
9.6.2v.	Appendix 10 (6)	Relocated	
9.6.2w.	Appendix 10 (7)	Relocated	
9.6.2x.	Appendix 10 (8)	Relocated	
9.6.2x.(1)	Appendix 10 (8.1)	Relocated	
9.6.2x.(2)	Appendix 10 (8.2)	Relocated	
9.6.2y.	Appendix 10 (9)	Relocated	
9.6.2y.(1)	Appendix 10 (9.1)	Relocated	
9.6.2y.(2)	Appendix 10 (9.2)	Relocated	
9.6.2y.(2)(a)	Appendix 10 (9.2)(a)	Relocated	
9.6.2y.(2)(b)	Appendix 10 (9.2)(b)	Relocated	
9.6.2y.(3)	Appendix 10 (9.3)	Relocated	
9.6.2y.(4)	Appendix 10 (9.4)	Relocated	
9.6.3	Appendix 12	Relocated	
9.6.3a.	Appendix 12 (1)	Relocated	
9.6.3b.	Appendix 12	Relocated	
9.6.3b.(1)	Appendix 12 (6)	Relocated	
9.6.3b.(2)	Appendix 12 (7)	Relocated	
9.6.3c.	Appendix 12	Relocated	
9.6.3c.(1)	Appendix 12 (8)	Relocated	
9.6.3c.(2)	Appendix 12 (9)	Relocated	
9.6.3d.	Appendix 12	Relocated	
9.6.3d.(1)	Appendix 12 (10)	Relocated	
9.6.3d.(2)	Appendix 12 (10)	Relocated	
9.6.3d.(3)	Appendix 12 (10)	Relocated	
9.6.3d.(4)	Appendix 12 (10)	Relocated	
9.6.3d.(5)	Appendix 12 (10)	Relocated	
9.6.3d.(6)	Appendix 12 (10)	Relocated	
9.6.3e.	Appendix 12 (11)	Relocated	

Fire Code 2018	Fire Code 2013	Clause Status	Effective Date
Clause No.	Clause No.		
9.6.3f.	Appendix 12	Relocated	
9.6.3f.(1)	Appendix 12 (12)	Relocated	
9.6.3f.(2)	Appendix 12 (12)	Relocated	
9.6.3f.(3)	Appendix 12 (12)	Relocated	
9.6.3f.(4)	Appendix 12 (12)	Relocated	
9.6.3g.(1)	Appendix 12 (13)	Relocated	
9.6.3g.(2)	Appendix 12 (14)	Relocated	
9.7	---	---	
9.7.1	---	---	
9.7.2	2.7	Renumbered	
9.7.2a.	2.7.1	Renumbered	
9.7.2a.(1)	2.7.1(a)	Renumbered	
9.7.2a.(2)	2.7.1(b)	Renumbered	
9.7.2a.(3)	2.7.1(c)	Renumbered, rephrased	
9.7.2a.(4)	2.7.1(d)	Renumbered	
9.7.2b.	2.7.2	Renumbered	
9.7.2b.(1)	2.7.2(a)	Renumbered	
9.7.2b.(2)	2.7.2(b)	Renumbered	
9.7.2b.(3)	2.7.2(c)	Revised	01.03.2019
9.7.2c.	2.7.3	Renumbered	
9.7.2d.	2.7.4	Renumbered	
9.7.2d.(1)	2.7.4(a)	Renumbered	
9.7.2d.(1)(a)	2.7.4(a)	Renumbered	
9.7.2d.(1)(b)	2.7.4(a)	Renumbered	
9.7.2d.(2)	2.7.4(b)	Renumbered	
9.7.2d.(2)(a)	2.7.4(b)	Renumbered	
9.7.2d.(2)(b)	2.7.4(c)	Renumbered	
9.7.2d.(2)(c)	2.7.4(d)	Renumbered	
9.7.2d.(2)(d)	2.7.4(e)	Renumbered	
9.7.2d.(2)(e)	2.7.4(f)	Renumbered	
9.7.2e.	Appendix 20 (7.3.1)	Relocated	
9.7.3	2.8	Renumbered	
9.7.3a.	2.8.2	Renumbered	
9.7.3b.	2.8.3	Renumbered	
9.7.3b.(1)	2.8.3	Renumbered	
9.7.3b.(1)(a)	2.8.3(a)	Renumbered	
9.7.3b.(1)(b)	2.8.3(b)	Renumbered	
9.7.3b.(1)(c)	2.8.3(c)	Renumbered	
9.7.3b.(1)(d)	2.8.3(d)	Renumbered	
9.7.3b.(1)(e)	2.8.3(e)	Renumbered	
9.7.3b.(1)(f)	2.8.3(f)	Renumbered	
9.7.3b.(1)(g)	2.8.3(g)	Renumbered	
9.7.3b.(1)(g)(i)	2.8.3(g)(i)	Renumbered	
9.7.3b.(1)(g)(ii)	2.8.3(g)(ii)	Renumbered	
9.7.3b.(1)(g)(iii)	2.8.3(g)(iii)	Renumbered	
9.7.3b.(2)	2.8.4	Renumbered	
9.7.3b.(2)(a)	2.8.4(a)	Renumbered	
9.7.3b.(2)(b)	2.8.4(b)	Renumbered	
9.7.3b.(2)(c)	2.8.4(c)	Renumbered	
9.7.3b.(3)	3.2.5(g)	Renumbered	

Fire Code 2018	Fire Code 2013	Clause Status	Effective Date
Clause No.	Clause No.		
9.7.3b.(3)(a)	3.2.5(g)(i)	Renumbered	
9.7.3b.(3)(b)	3.2.5(g)(ii)	Renumbered	
9.7.3b.(4)	3.2.5(h)	Renumbered	
9.7.3b.(4)(a)	3.2.5(h)(i)	Renumbered	
9.7.3b.(4)(b)	3.2.5(h)(iv)	Renumbered	
9.7.3b.(4)(c)	3.2.5(h)(ii)	Renumbered	
9.7.3b.(4)(d)	3.2.5(h)(iii)	Renumbered	
9.7.3b.(5)	---	---	
9.7.3b.(5)(a)	7.7.1	Renumbered, revised	01.03.2019
9.7.3b.(5)(a)(i)	7.7.1	Renumbered, revised	01.03.2019
9.7.3b.(5)(a)(ii)	7.7.1	Renumbered, revised	01.03.2019
9.7.3b.(5)(b)	7.7.1	Renumbered, revised	01.03.2019
9.7.3b.(5)(c)	7.7.2	Renumbered, revised	01.03.2019
9.7.4	---	Extracted from circular dated 31 Jul 2014	31.01.2015
9.7.4a.	---	Extracted from circular dated 31 Jul 2014	31.01.2015
9.7.4a.(1)	---	Extracted from circular dated 31 Jul 2014	31.01.2015
9.7.4a.(2)	---	Extracted from circular dated 31 Jul 2014	31.01.2015
9.7.4a.(3)	---	Extracted from circular dated 31 Jul 2014	31.01.2015
9.7.4b.	---	Extracted from circular dated 31 Jul 2014	31.01.2015
9.7.4b.(1)	---	Extracted from circular dated 31 Jul 2014	31.01.2015
9.7.4b.(1)(a)	---	Extracted from circular dated 31 Jul 2014	31.01.2015
9.7.4b.(1)(b)	---	Extracted from circular dated 31 Jul 2014	31.01.2015
9.7.4b.(2)	---	Extracted from circular dated 31 Jul 2014	31.01.2015
9.7.4b.(2)(a)	---	Extracted from circular dated 31 Jul 2014	31.01.2015
9.7.4b.(2)(b)	---	Extracted from circular dated 31 Jul 2014	31.01.2015
9.7.4b.(2)(c)	---	Extracted from circular dated 31 Jul 2014	31.01.2015
9.7.4b.(3)	---	Extracted from circular dated 31 Jul 2014	31.01.2015
9.7.4b.(3)(a)	---	Extracted from circular dated 31 Jul 2014	31.01.2015
9.7.4b.(3)(b)	---	Extracted from circular dated 31 Jul 2014	31.01.2015
9.7.4b.(3)(c)	---	Extracted from circular dated 31 Jul 2014	31.01.2015
9.7.4b.(3)(d)	---	Extracted from circular dated 31 Jul 2014	31.01.2015
9.7.4b.(3)(e)	---	Extracted from circular dated 31 Jul 2014	31.01.2015
9.7.4b.(4)	---	Extracted from circular dated 31 Jul 2014	31.01.2015
9.7.4b.(4)(a)	---	Extracted from circular dated 31 Jul 2014	31.01.2015
9.7.4b.(4)(b)	---	Extracted from circular dated 31 Jul 2014	31.01.2015
9.7.4b.(4)(b)(i)	---	Extracted from circular dated 31 Jul 2014	31.01.2015
9.7.4b.(4)(b)(ii)	---	Extracted from circular dated 31 Jul 2014	31.01.2015
9.7.4b.(4)(b)(iii)	---	Extracted from circular dated 31 Jul 2014	31.01.2015
9.7.4b.(4)(b)(iv)	---	Extracted from circular dated 31 Jul 2014	31.01.2015
9.7.4b.(4)(b)(v)	---	Extracted from circular dated 31 Jul 2014	31.01.2015
9.7.4b.(4)(b)(vi)	---	Extracted from circular dated 31 Jul 2014	31.01.2015
9.7.4b.(4)(c)	---	Extracted from circular dated 31 Jul 2014	31.01.2015
9.7.4b.(4)(c)(i)	---	Extracted from circular dated 31 Jul 2014	31.01.2015
9.7.4b.(4)(c)(ii)	---	Extracted from circular dated 31 Jul 2014	31.01.2015
9.7.4b.(4)(c)(iii)	---	Extracted from circular dated 31 Jul 2014	31.01.2015
9.7.4b.(4)(c)(iv)	---	Extracted from circular dated 31 Jul 2014	31.01.2015
9.7.4b.(4)(c)(v)	---	Extracted from circular dated 31 Jul 2014	31.01.2015
9.7.4b.(4)(d)	---	Extracted from circular dated 31 Jul 2014	31.01.2015
9.7.4b.(4)(d)(i)	---	Extracted from circular dated 31 Jul 2014	31.01.2015
9.7.4b.(4)(d)(ii)	---	Extracted from circular dated 31 Jul 2014	31.01.2015

Fire Code 2018	Fire Code 2013	Clause Status	Effective Date
Clause No.	Clause No.		
9.7.4b.(4)(d)(iii)	---	Extracted from circular dated 31 Jul 2014	31.01.2015
9.7.4b.(4)(d)(iv)	---	Extracted from circular dated 31 Jul 2014	31.01.2015
9.7.4b.(4)(d)(v)	---	Extracted from circular dated 31 Jul 2014	31.01.2015
9.7.4b.(4)(e)	---	Extracted from circular dated 31 Jul 2014	31.01.2015
9.7.4b.(5)	---	Extracted from circular dated 31 Jul 2014	31.01.2015
9.7.4b.(5)(a)	---	Extracted from circular dated 31 Jul 2014	31.01.2015
9.7.4b.(5)(b)	---	Extracted from circular dated 31 Jul 2014	31.01.2015
9.7.4b.(5)(c)	---	Extracted from circular dated 31 Jul 2014	31.01.2015
9.7.4b.(5)(d)	---	Extracted from circular dated 31 Jul 2014	31.01.2015
9.8	---	---	
9.8.1	---	---	
9.8.1a.	---	---	
9.8.1a.(1)	2.6.1	Renumbered	
9.8.1a.(1)(a)	2.6.1(d)	Renumbered	
9.8.1a.(1)(b)	2.6.1	Renumbered	
9.8.1a.(1)(c)	2.6.1(c)	Renumbered	
9.8.1a.(2)	2.6.2	Renumbered	
9.8.1a.(2)(a)	2.6.2(d)	Renumbered	
9.8.1a.(2)(b)	2.6.2(b)	Renumbered	
9.8.1a.(2)(c)	2.6.2(c)	Renumbered	
9.8.1a.(2)(d)	2.6.2(b)	Renumbered	
9.8.1a.(2)(e)	2.6.2(e)	Renumbered	
9.8.1a.(2)(f)	2.6.2(f)	Renumbered	
9.8.1b.	---	---	
9.8.1b.(1)	3.2.5(q)	Renumbered, rephrased	
9.8.1b.(1)(a)	Nil	New	01.03.2019
9.8.1b.(1)(b)	Nil	New	01.03.2019
9.8.1b.(2)	3.2.5(r)	Renumbered	
9.8.2	3.2.5(m)(1)	Renumbered, rephrased	
9.8.2a.	---	---	
9.8.2a.(1)	3.2.5(m)(i)	Extracted from circular dated 8 Sep 2016	01.01.2017
9.8.2a.(2)	3.2.5(m)(ii)	Extracted from circular dated 8 Sep 2016	01.01.2017
9.8.2a.(3)	3.2.5(m)(ii)	Extracted from circular dated 8 Sep 2016	01.01.2017
9.8.2b.	3.2.5(m)(ii)	Extracted from circular dated 8 Sep 2016	01.01.2017
9.8.2c.	3.2.5(m)(ii)	Extracted from circular dated 8 Sep 2016	01.01.2017
9.8.2c.(1)	3.2.5(m)(iii)	Extracted from circular dated 8 Sep 2016	01.01.2017
9.8.2c.(2)	3.2.5(m)(ii)	Extracted from circular dated 8 Sep 2016	01.01.2017
9.8.2c.(3)	3.2.5(m)(ii)	Extracted from circular dated 8 Sep 2016	01.01.2017
9.8.2d.	3.2.5(m)(ii)	Extracted from circular dated 8 Sep 2016	01.01.2017
9.8.2e.	3.2.5(m)(ii)	Extracted from circular dated 8 Sep 2016	01.01.2017
9.8.3	Appendix 4	Relocated	
9.8.3a.	Appendix 4 (1.1)	Relocated	
9.8.3b.	Appendix 4 (3)	Relocated	
9.8.3b.(1)	Appendix 4 (2.1)	Relocated	
9.8.3b.(2)	Appendix 4 (3.1)	Relocated	
9.8.3b.(3)	Appendix 4 (3.2)	Relocated	
9.8.3b.(4)	Appendix 4 (3.3)	Relocated	
9.8.3b.(4)(a)	Appendix 4 (3.3(i))	Relocated	
9.8.3b.(4)(b)	Appendix 4 (3.3(ii))	Relocated	
9.8.3b.(5)	Appendix 4 (3.4)	Relocated	

Fire Code 2018	Fire Code 2013	Clause Status	Effective Date
Clause No.	Clause No.		
9.8.3c.	Appendix 4 (4)	Relocated	
9.8.3c.(1)	Appendix 4 (4.1)	Relocated	
9.8.3c.(2)	Appendix 4 (4.2)	Relocated	
9.8.3d.	Appendix 4 (5)	Relocated	
9.8.3d.(1)	Appendix 4 (5.1)	Relocated	
9.8.3d.(2)	Appendix 4 (5.2)	Relocated	
9.8.3d.(3)	Appendix 4 (5.3)	Relocated	
9.8.3d.(4)	Appendix 4 (5.4)	Relocated	
9.8.3d.(5)	Appendix 4 (5.5)	Relocated	
9.8.3e.	Appendix 4 (6)	Relocated	
9.8.3e.(1)	Appendix 4 (6.1)	Relocated	
9.8.3e.(2)	Appendix 4 (6.2)	Relocated	
9.8.3e.(2)(a)	Appendix 4 (6.2.1)	Relocated	
9.8.3e.(2)(b)	Appendix 4 (6.2.2)	Relocated	
9.8.3e.(2)(c)	Appendix 4 (6.2.3)	Relocated	
9.8.3e.(2)(d)	Appendix 4 (6.2.4)	Relocated	
9.8.3e.(3)	Appendix 4 (6.3)	Relocated	
9.8.3e.(4)	Appendix 4 (6.4)	Relocated	
9.8.3e.(4)(a)	Appendix 4 (6.4.1)	Relocated	
9.8.3e.(4)(b)	Appendix 4 (6.4.2)	Relocated	
9.8.3e.(4)(c)	Appendix 4 (6.4.3)	Relocated	
9.8.3f.	Appendix 4 (7)	Relocated	
9.8.3f.(1)	Appendix 4 (7.1)	Relocated	
9.8.3f.(2)	Appendix 4 (7.2)	Relocated	
9.8.4	Appendix 2	Relocated	
9.8.4a.	Appendix 2 (1)	Relocated	
9.8.4a.(1)	Appendix 2 (1)	Relocated	
9.8.4a.(2)	Appendix 2 (1)	Relocated	
9.8.4b.	Appendix 2 (2)	Relocated	
9.8.4c.	Appendix 2 (3)	Relocated	
9.8.4c.(1)	Appendix 2 (3.1)	Relocated	
9.8.4c.(2)	Appendix 2 (3.2)	Relocated	
9.8.4c.(3)	Appendix 2 (3.3)	Relocated	
9.8.4c.(4)	Appendix 2 (3.4)	Relocated	
9.8.4c.(5)	Appendix 2 (3.5)	Relocated	
9.8.4c.(6)	Appendix 2 (3.6)	Relocated	
9.8.4c.(7)	Appendix 2 (3.7)	Relocated	
9.8.4c.(8)	Appendix 2 (3.8)	Relocated	
9.8.4c.(9)	Appendix 2 (3.9)	Relocated	
9.8.4c.(10)	Appendix 2 (3.10)	Relocated	
9.8.4c.(11)	Appendix 2 (3.11)	Relocated	
9.8.4c.(12)	Appendix 2 (3.12)	Relocated	
9.8.4d.	Appendix 2 (4)	Relocated	
9.8.4d.(1)	Appendix 2 (4.2)	Relocated	
9.8.4d.(2)	Appendix 2 (4.3)	Relocated	
9.8.4d.(3)	Appendix 2 (4.4)	Relocated	
9.8.4d.(4)	Appendix 2 (4.5)	Relocated	
9.8.4d.(5)	Appendix 2 (4.6)	Relocated	
9.8.4d.(6)	Appendix 2 (4.7)	Relocated	
9.8.4e.	Appendix 2 (5)	Relocated	

Fire Code 2018	Fire Code 2013	Clause Status	Effective Date
Clause No.	Clause No.		
9.8.4e.(1)	Appendix 2 (5.1)	Relocated	
9.8.4e.(1)(a)	Appendix 2 (5.1(a))	Relocated	
9.8.4e.(1)(b)	Appendix 2(5.1(b))	Relocated	
9.8.4e.(2)	Appendix 2 (5.2)	Relocated	
9.8.4f.	Appendix 2 (6)	Relocated	
9.8.4f.(1)	Appendix 2 (6.1)	Relocated	
9.8.4f.(2)	Appendix 2 (6.2)	Relocated	
9.8.4f.(3)	Appendix 2 (6.3)	Relocated	
9.8.4f.(4)	Appendix 2 (6.4)	Relocated	
9.8.4f.(5)	Appendix 2 (6.5)	Relocated	
9.8.4f.(6)	Appendix 2 (6.5)	Relocated	
9.8.4g.	Appendix 2 (7)	Relocated	
9.8.4g.(1)	Appendix 2 (7.1)	Relocated	
9.8.4g.(2)	Appendix 2 (7.2)	Relocated	
9.8.4g.(3)	Appendix 2 (7.3)	Relocated	
9.8.4h.	Appendix 2 (8)	Relocated	
9.8.4h.(1)	Appendix 2 (8.1)	Relocated	
9.8.4h.(2)	Appendix 2 (8.2)	Relocated	
9.8.4i.	Appendix 2 (9)	Relocated	
9.8.4i.(1)	Appendix 2 (9(a),(c))	Relocated	
9.8.4i.(2)	Appendix 2 (9(e),(f),(g),(h),(b),(d))	Relocated	
9.8.4i.(3)	Appendix 2 (9(q),(r))	Relocated	
9.8.4i.(4)	Appendix 2 (9(i),(j),(k),(l),(m),(n),(o),(p))	Relocated	
9.8.5	Appendix 5	Relocated	
9.8.5a.	Appendix 5 (1)	Relocated	
9.8.5b.	Appendix 5 (3)	Relocated	
9.8.5c.	Appendix 5 (7)	Relocated	
9.8.5c.(1)	Appendix 5 (7)(Category 1a)	Relocated	
9.8.5c.(1)(a)	Appendix 5 (7)(Category 1a)	Relocated	
9.8.5c.(1)(b)	Appendix 5 (7)(Category 1a)	Relocated	
9.8.5c.(1)(c)	Appendix 5 (7)(Category 1a)	Relocated	
9.8.5c.(1)(d)	Appendix 5 (7)(Category 1a)	Relocated	
9.8.5c.(2)	Appendix 5 (7)(Category 1b)	Relocated	
9.8.5c.(2)(a)	Appendix 5 (7)(Category 1b)	Relocated	
9.8.5c.(2)(b)	Appendix 5 (7)(Category 1b)	Relocated	
9.8.5c.(2)(c)	Appendix 5 (7)(Category 1b)	Relocated	
9.8.5c.(2)(d)	Appendix 5 (7)(Category 1b)	Relocated	
9.8.5c.(3)	Appendix 5 (7)(Category 2)	Relocated	
9.8.5c.(4)	Appendix 5 (7)(Category 4)	Relocated	

Fire Code 2018	Fire Code 2013	Clause Status	Effective Date
Clause No.	Clause No.		
9.8.5d.	Appendix 5 (8)	Relocated	
9.8.5d.(1)	Appendix 5 (8(a))	Relocated	
9.8.5d.(2)	Appendix 5 (8(b))	Relocated	
9.8.5d.(3)	Appendix 5 (8(c))	Relocated	
9.8.5d.(4)	Appendix 5 (8(d))	Relocated	
9.8.5d.(5)	Appendix 5 (8(e))	Relocated	
9.8.5d.(6)	Appendix 5 (8(f))	Relocated	
9.8.5d.(7)	Appendix 5 (8(g))	Relocated	
9.8.5d.(8)	Appendix 5 (8(h))	Relocated	
9.8.5d.(9)	Appendix 5 (8(i))	Relocated	
9.8.5d.(10)	Appendix 5 (8(j))	Relocated	
9.8.5e.	Appendix 5 (9)	Relocated	
9.8.5e.(1)	Appendix 5 (9(a))	Relocated	
9.8.5e.(2)	Appendix 5 (9(b))	Relocated	
9.8.5e.(3)	Appendix 5 (9(c))	Relocated	
9.8.5e.(4)	Appendix 5 (9(d))	Relocated	
9.8.5e.(5)	Appendix 5 (9(e))	Relocated	
9.8.5e.(6)	Appendix 5 (9(f))	Relocated	
9.8.5f.	Appendix 5 (10)	Relocated	
9.8.5f.(1)	---	Extracted from circular dated 2 Nov 2015	01.05.2016
9.8.5f.(2)	Appendix 5 (10(c))	Relocated	
9.8.5f.(3)	Appendix 5 (10(d))	Relocated	
9.8.5f.(3)(a)	Appendix 5 (10)(d)(1)(i)	Relocated	
9.8.5f.(3)(b)	Appendix 5 (10)(d)(1)(ii)	Relocated	
9.8.5f.(3)(c)	Appendix 5 (10)(d)(1)(iii)	Relocated	
9.8.5f.(3)(d)	Appendix 5 (10)(d)(1)(iv)	Relocated	
9.8.5f.(3)(d)(i)	Appendix 5 (10)(2)(iii)	Relocated	
9.8.5f.(3)(d)(ii)	Appendix 5 (10)(2)(i)	Relocated	
9.8.5f.(3)(e)	Appendix 5 (10)(1)(v)	Relocated	
9.8.5f.(3)(f)	Appendix 5 (10)(1)(vi)	Relocated	
9.8.5f.(3)(g)	Appendix 5 (10)(1)(vii)	Relocated	
9.8.5f.(3)(h)	Appendix 5 (10)(1)(viii)	Relocated	
9.8.5f.(3)(i)	Appendix 5 (10)(1)(ix)	Relocated	
9.8.5f.(3)(j)	Appendix 5 (10)(2)(e)	Relocated	
9.8.5f.(3)(k)	Appendix 5 (10)(2)(vi)	Relocated	
9.8.5f.(3)(l)	Appendix 5 (10)(2)(l)	Relocated	
9.8.5f.(3)(l)(i)	---	Extracted from circular dated 2 Nov 2015	01.05.2016
9.8.5f.(3)(l)(ii)	---	Extracted from circular dated 2 Nov 2015	01.05.2016
9.8.5f.(3)(l)(iii)	---	Extracted from circular dated 2 Nov 2015	01.05.2016
9.8.5f.(3)(l)(iv)	---	Extracted from circular dated 2 Nov 2015	01.05.2016
9.8.5f.(3)(l)(v)	---	Extracted from circular dated 2 Nov 2015	01.05.2016
9.8.5f.(3)(m)	---	Extracted from circular dated 2 Nov 2015	01.05.2016
9.8.5f.(3)(n)	Appendix 5 (10)(2)(g)	Relocated	
9.8.5f.(3)(o)	---	Extracted from circular dated 2 Nov 2015	01.05.2016
9.8.5f.(3)(p)	---	Extracted from circular dated 2 Nov 2015	01.05.2016
9.8.5f.(3)(q)	---	Extracted from circular dated 2 Nov 2015	01.05.2016
9.8.5f.(3)(r)	---	Extracted from circular dated 2 Nov 2015	01.05.2016
9.8.5f.(3)(s)	---	Extracted from circular dated 2 Nov 2015	01.05.2016
9.8.5f.(3)(t)	---	Extracted from circular dated 2 Nov 2015	01.05.2016
9.8.5g.	Appendix 5 (11)	Relocated	

Fire Code 2018

Fire Code 2018	Fire Code 2013	Clause Status	Effective Date
Clause No.	Clause No.		
9.8.5g.(1)	Appendix 5 (11(a))	Relocated	
9.8.5g.(2)	---	Extracted from circular dated 2 Nov 2015	01.05.2016
9.8.5g.(3)	Appendix 5 (11(c))	Relocated	
9.8.5g.(4)	Appendix 5 (11(d))	Relocated	
9.8.5g.(4)(a)	Appendix 5 (11)(d)(1)(i)	Relocated	
9.8.5g.(4)(b)	Appendix 5 (11)(d)(1)(ii)	Relocated	
9.8.5g.(4)(c)	Appendix 5 (11)(d)(1)(iii)	Relocated	
9.8.5g.(4)(d)	Appendix 5 (11)(d)(1)(iv)	Relocated	
9.8.5g.(4)(d)(i)	Appendix 5 (11)(d)(1)(iv) (a)	Relocated	
9.8.5g.(4)(d)(ii)	Appendix 5 (11)(d)(1)(iv) (b)	Relocated	
9.8.5g.(4)(e)	Appendix 5 (11)(d)(1)(v)	Relocated	
9.8.5g.(4)(f)	Appendix 5 (11)(d)(1)(vi)	Relocated	
9.8.5g.(4)(g)	Appendix 5 (11)(d)(1)(vii)	Relocated	
9.8.5g.(4)(h)	Appendix 5 (11)(d)(1)(viii)	Relocated	
9.8.5g.(4)(h)(i)	Appendix 5 (11)(d)(1)(viii) (a)	Relocated	
9.8.5g.(4)(h)(ii)	Appendix 5 (11)(d)(1)(viii) (b)	Relocated	
9.8.5g.(4)(i)	Appendix 5 (11)(d)(1)(ix)	Relocated	
9.8.5g.(4)(j)	Appendix 5 (11)(d)(1)(iix)	Relocated	
9.8.5g.(5)	Appendix 5 (11(f))	Relocated	
9.8.5g.(6)	Appendix 5 (11(e))	Relocated	
9.8.5g.(7)	Appendix 5 (11(g))	Relocated	
9.8.5g.(7)(a)	---	Extracted from circular dated 2 Nov 2015	01.05.2016
9.8.5g.(7)(b)	---	Extracted from circular dated 2 Nov 2015	01.05.2016
9.8.5g.(7)(b)(i)	---	Extracted from circular dated 2 Nov 2015	01.05.2016
9.8.5g.(7)(b)(ii)	---	Extracted from circular dated 2 Nov 2015	01.05.2016
9.8.5g.(7)(b)(iii)	---	Extracted from circular dated 2 Nov 2015	01.05.2016
9.8.5g.(7)(b)(iv)	---	Extracted from circular dated 2 Nov 2015	01.05.2016
9.8.5g.(7)(c)	Appendix 5 (11(i))	Relocated	
9.8.5g.(8)	---	Extracted from circular dated 2 Nov 2015	01.05.2016
9.8.5g.(9)	Appendix 5 (11)(h)	Relocated	
9.8.5g.(9)(a)	Appendix 5 (11)(h)	Relocated	
9.8.5g.(9)(b)	Appendix 5 (11)(h)	Relocated	
9.8.5g.(9)(c)	---	Extracted from circular dated 2 Nov 2015	01.05.2016
9.8.5g.(9)(d)	---	Extracted from circular dated 2 Nov 2015	01.05.2016
9.8.5g.(10)	---	Extracted from circular dated 2 Nov 2015	01.05.2016
9.8.5g.(10)(a)	---	Extracted from circular dated 2 Nov 2015	01.05.2016
9.8.5g.(10)(b)	---	Extracted from circular dated 2 Nov 2015	01.05.2016
9.8.5g.(11)	---	Extracted from circular dated 2 Nov 2015	01.05.2016
9.8.5g.(12)	---	Extracted from circular dated 2 Nov 2015	01.05.2016
9.8.5g.(13)	---	Extracted from circular dated 2 Nov 2015	01.05.2016
9.9	Appendix 1	Relocated	
9.9.1	Appendix 1	Relocated	
9.9.1a.	Appendix 1	Relocated	
9.9.1b.	Appendix 1 (1)	Relocated	
9.9.1b.(1)	Appendix 1 (1)	Relocated	
9.9.1b.(1)(a)	Appendix 1 (1)	Relocated	

Fire Code 2018	Fire Code 2013	Clause Status	Effective Date
Clause No.	Clause No.		
9.9.1b.(2)	Appendix 1 (1)	Relocated	
9.9.1b.(2)(a)	Appendix 1 (1)	Relocated	
9.9.1b.(2)(b)	Appendix 1 (1)	Relocated	
9.9.1c.	Appendix 1 (2)	Relocated	
9.9.1c.(1)	Appendix 1 (2)	Relocated	
9.9.1c.(1)(a)	Appendix 1 (2)	Relocated	
9.9.1c.(1)(b)	Appendix 1 (2)	Relocated	
9.9.1c.(1)(c)	Appendix 1 (2)	Relocated	
9.9.1c.(1)(d)	Appendix 1 (2)	Relocated	
9.9.1c.(1)(e)	Appendix 1 (2)	Relocated	
9.9.1c.(2)	Appendix 1 (2)	Relocated	
9.9.1c.(2)(a)	Appendix 1 (2)	Relocated	
9.9.1c.(2)(b)	Appendix 1 (2)	Relocated	
9.9.1c.(2)(c)	Appendix 1 (2)	Relocated	
9.9.1c.(2)(d)	Appendix 1 (2)	Relocated	
9.9.1c.(2)(e)	Appendix 1 (2)	Relocated	
9.9.1c.(2)(f)	Appendix 1 (2)	Relocated	
9.9.1d.	Appendix 1 (3)	Relocated	
9.9.1d.(1)	Appendix 1 (3)	Relocated	
9.9.1d.(1)(a)	Appendix 1 (3)	Relocated	
9.9.1d.(1)(a)(i)	Appendix 1 (3)	Relocated	
9.9.1d.(1)(a)(ii)	Appendix 1 (3)	Relocated	
9.9.1d.(1)(b)	Appendix 1 (3)	Relocated	
9.9.1d.(1)(c)	Appendix 1 (3)	Relocated	
9.9.1d.(1)(c)(i)	Appendix 1 (3)	Relocated	
9.9.1d.(1)(c)(ii)	Appendix 1 (3)	Relocated	
9.9.1d.(1)(c)(iii)	Appendix 1 (3)	Relocated	
9.9.1d.(2)	Appendix 1 (3)	Relocated	
9.9.1d.(2)(a)	Appendix 1 (3)	Relocated	
9.9.1d.(2)(a)(i)	Appendix 1 (3)	Relocated	
9.9.1d.(2)(a)(ii)	Appendix 1 (3)	Relocated	
9.9.1d.(2)(b)	Appendix 1 (3)	Relocated	
9.9.1d.(3)	Appendix 1 (3)	Relocated	
9.9.1d.(3)(a)	Appendix 1 (3)	Relocated	
9.9.1d.(3)(a)(i)	Appendix 1 (3)	Relocated	
9.9.1d.(3)(a)(ii)	Appendix 1 (3)	Relocated	
9.9.1e.	Appendix 1 (4)	Relocated	
9.9.1e.(1)	Appendix 1 (4)	Relocated	
9.9.1e.(1)(a)	Appendix 1 (4)	Relocated	
9.9.1e.(1)(a)(i)	Appendix 1 (4)	Relocated	
9.9.1e.(1)(a)(ii)	Appendix 1 (4)	Relocated	
9.9.1e.(1)(b)	Appendix 1 (4)	Relocated	
9.9.1e.(1)(b)(i)	Appendix 1 (4)	Relocated	
9.9.1e.(1)(b)(ii)	Appendix 1 (4)	Relocated	
9.9.1e.(1)(c)	Appendix 1 (4)	Relocated	
9.9.1e.(2)	Appendix 1 (4)	Relocated	
9.9.1e.(2)(a)	Appendix 1 (4)	Relocated	
9.9.1e.(2)(b)	Appendix 1 (4)	Relocated	
9.9.1f.	Appendix 1 (5)	Relocated	
9.9.1f.(1)	Appendix 1 (5)	Relocated	

Fire Code 2018	Fire Code 2013	Clause Status	Effective Date
Clause No.	Clause No.		
9.9.1f.(2)	Appendix 1 (5)	Relocated	
9.9.1f.(3)	Appendix 1 (5)	Relocated	
9.9.1f.(4)	Appendix 1 (5)	Relocated	
9.9.1g.	Appendix 1 (6)	Relocated	
9.9.1g.(1)	Appendix 1 (6)	Relocated	
9.9.1g.(2)	Appendix 1 (6)	Relocated	
9.9.1h.	Appendix 1 (7)	Relocated	
9.9.1h.(1)	Appendix 1 (7)	Relocated	
9.9.1h.(2)	Appendix 1 (7)	Relocated	
9.9.1i.	Appendix 1 (8)	Relocated	
9.9.1i.(1)	Appendix 1 (8)	Relocated	
9.9.1i.(2)	Appendix 1 (8)	Relocated	
9.9.1j.	Appendix 1 (9)	Relocated	
9.9.1j.(1)	Appendix 1 (9)	Relocated	
9.9.1j.(2)	Appendix 1 (9)	Relocated	
9.9.1k.	Appendix 1 (10)	Relocated	
9.9.1k.(1)	Appendix 1 (10)	Relocated	
9.9.1k.(2)	Appendix 1 (10)	Relocated	
9.9.1l.	Appendix 1 (11)	Relocated	
9.9.1l.(1)	Appendix 1 (11)	Relocated	
9.9.1l.(1)(a)	Appendix 1 (11)	Relocated	
9.9.1l.(1)(b)	Appendix 1 (11)	Relocated	
9.9.1l.(1)(c)	Appendix 1 (11)	Relocated	
9.9.1l.(1)(d)	Appendix 1 (11)	Relocated	
9.9.1l.(1)(e)	Appendix 1 (11)	Relocated	
9.9.1l.(2)	Appendix 1 (11)	Relocated	
9.9.1l.(2)(a)	Appendix 1 (11)	Relocated	
9.9.1l.(2)(b)	Appendix 1 (11)	Relocated	
9.9.1l.(2)(c)	Appendix 1 (11)	Relocated	
9.9.2	Appendix 16	Relocated	
9.9.2a.	Appendix 16 (1.1)	Relocated	
9.9.2b.	Appendix 16 (3.2)	Relocated	
9.9.3	Appendix 3	Relocated	
9.9.3a.	Appendix 3 (2a)	Relocated	
9.9.3a.(1)	Appendix 3 (2a)(i)	Relocated	
9.9.3a.(2)	Appendix 3 (2a)(ii)	Relocated	
9.9.3b.	Appendix 3 (2b)	Relocated	
9.9.3c.	Appendix 3 (2c)	Relocated	
9.9.3d.	Appendix 3 (2d)	Relocated	
9.9.3d.(1)	Appendix 3 (2d)(i)	Relocated	
9.9.3d.(2)	Appendix 3 (2d)(ii)	Relocated	
9.9.3e.	Appendix 3 (2e)	Relocated	
9.9.3e.(1)	Appendix 3 (2e)(i)	Relocated	
9.9.3e.(2)	Appendix 3 (2e)(ii)	Relocated	
9.9.3f.	Appendix 3 (Annex A)	Relocated	
9.9.4	---	Extracted from circular dated 1 Mar 2016	01.09.2016
9.9.4a.	---	Extracted from circular dated 1 Mar 2016	01.09.2016
9.9.4a.(1)	---	Extracted from circular dated 1 Mar 2016	01.09.2016
9.9.4a.(2)	---	Extracted from circular dated 1 Mar 2016	01.09.2016
9.9.4a.(2)(a)	---	Extracted from circular dated 1 Mar 2016	01.09.2016

Fire Code 2018	Fire Code 2013	Clause Status	Effective Date
Clause No.	Clause No.		
9.9.4a.(2)(b)	---	Extracted from circular dated 1 Mar 2016	01.09.2016
9.9.4a.(2)(c)	---	Extracted from circular dated 1 Mar 2016	01.09.2016
9.9.4a.(2)(d)	---	Extracted from circular dated 1 Mar 2016	01.09.2016
9.9.4a.(2)(e)	---	Extracted from circular dated 1 Mar 2016	01.09.2016
9.9.4a.(3)	---	Extracted from circular dated 1 Mar 2016	01.09.2016
9.9.4b.	---	Extracted from circular dated 1 Mar 2016	01.09.2016
9.9.4b.(1)	---	Extracted from circular dated 1 Mar 2016	01.09.2016
9.9.4b.(1)(a)	---	Extracted from circular dated 1 Mar 2016	01.09.2016
9.9.4b.(1)(b)	---	Extracted from circular dated 1 Mar 2016	01.09.2016
9.9.4b.(2)	---	Extracted from circular dated 1 Mar 2016	01.09.2016
9.9.4b.(2)(a)	---	Extracted from circular dated 1 Mar 2016	01.09.2016
9.9.4b.(2)(b)	---	Extracted from circular dated 1 Mar 2016	01.09.2016
9.9.4c.	---	Extracted from circular dated 1 Mar 2016	01.09.2016
9.9.4c.(1)	---	Extracted from circular dated 1 Mar 2016	01.09.2016
9.9.4c.(1)(a)	---	Extracted from circular dated 1 Mar 2016	01.09.2016
9.9.4c.(1)(b)	---	Extracted from circular dated 1 Mar 2016	01.09.2016
9.9.4c.(1)(c)	---	Extracted from circular dated 1 Mar 2016	01.09.2016
9.9.4c.(1)(d)	---	Extracted from circular dated 1 Mar 2016	01.09.2016
9.9.4c.(1)(e)	---	Extracted from circular dated 1 Mar 2016	01.09.2016
9.9.4c.(2)	---	Extracted from circular dated 1 Mar 2016	01.09.2016
9.9.4d.	---	Extracted from circular dated 1 Mar 2016	01.09.2016
9.9.4d.(1)	---	Extracted from circular dated 1 Mar 2016	01.09.2016
9.9.4d.(2)	---	Extracted from circular dated 1 Mar 2016	01.09.2016
9.9.5	---	Extracted from circular dated 6 Mar 2014	06.03.2014
9.9.5a.	---	Extracted from circular dated 6 Mar 2014	06.03.2014
9.9.5a.(1)	---	Extracted from circular dated 6 Mar 2014	06.03.2014
9.9.5a.(2)	---	Extracted from circular dated 6 Mar 2014	06.03.2014
9.9.5a.(3)	---	Extracted from circular dated 6 Mar 2014	06.03.2014
9.9.5b.	---	Extracted from circular dated 6 Mar 2014	06.03.2014
9.9.5b.(1)	---	Extracted from circular dated 6 Mar 2014	06.03.2014
9.9.5b.(2)	---	Extracted from circular dated 6 Mar 2014	06.03.2014
9.9.5b.(3)	---	Extracted from circular dated 6 Mar 2014	06.03.2014
9.9.5b.(3)(a)	---	Extracted from circular dated 6 Mar 2014	06.03.2014
9.9.5b.(3)(b)	---	Extracted from circular dated 6 Mar 2014	06.03.2014
9.9.5b.(3)(c)	---	Extracted from circular dated 6 Mar 2014	06.03.2014
9.9.5b.(3)(d)	---	Extracted from circular dated 6 Mar 2014	06.03.2014
9.9.5b.(4)	---	Extracted from circular dated 6 Mar 2014	06.03.2014
9.9.5b.(5)	---	Extracted from circular dated 6 Mar 2014	06.03.2014
9.9.5b.(6)	---	Extracted from circular dated 6 Mar 2014	06.03.2014
9.9.5b.(7)	---	Extracted from circular dated 6 Mar 2014	06.03.2014
9.9.5b.(8)	---	Extracted from circular dated 6 Mar 2014	06.03.2014
9.9.5b.(9)	---	Extracted from circular dated 6 Mar 2014	06.03.2014
9.9.5b.(10)	---	Extracted from circular dated 6 Mar 2014	06.03.2014
9.9.5b.(11)	---	Extracted from circular dated 6 Mar 2014	06.03.2014
9.9.6	Appendix 22	Relocated	
9.9.6a.	Appendix 22	Relocated	
9.9.6a.(1)	Appendix 22 (1)	Relocated	
9.9.6a.(1)(a)	Appendix 22 (1)	Relocated	
9.9.6a.(1)(b)	Appendix 22 (1)	Relocated	
9.9.6a.(1)(c)	Appendix 22 (1)	Relocated	

Fire Code 2018	Fire Code 2013	Clause Status	Effective Date
Clause No.	Clause No.		
9.9.6a.(1)(d)	Appendix 22 (1)	Relocated	
9.9.6a.(2)	Appendix 22 (3)	Relocated	
9.9.6a.(3)	Appendix 22 (4)	Relocated	
9.9.6a.(3)(a)	Appendix 22 (4)	Relocated	
9.9.6a.(3)(b)	Appendix 22 (4)	Relocated	
9.9.7	Appendix 23	Relocated	
9.9.7a.	Appendix 23 (1.1)	Relocated	
9.9.7b.	Appendix 23 (3.1)	Relocated	
9.9.7b.(1)	Appendix 23 (3.1)(a)	Relocated	
9.9.7b.(2)	Appendix 23 (3.1)(b)	Relocated	
9.9.7b.(3)	Appendix 23 (3.1)(c)	Relocated	
9.9.7b.(4)	Appendix 23 (3.1)(d)	Relocated	
9.9.7b.(5)	Appendix 23 (3.1)(e)	Relocated	
9.9.7b.(6)	Appendix 23 (3.1)(f)	Relocated	
9.9.7b.(7)	Appendix 23 (3.1)(g)	Relocated	
9.9.7c.	Appendix 23 (3.2)	Relocated	
9.9.7c.(1)	Appendix 23 (3.2)(a)	Relocated	
9.9.7c.(2)	Appendix 23 (3.2)(b)	Relocated	
9.9.7c.(3)	Appendix 23 (3.2)(c)	Relocated	
9.9.7c.(4)	Appendix 23 (3.2)(d)	Relocated	
9.9.7c.(5)	Appendix 23 (3.2)(e)	Relocated	
9.9.7c.(6)	Appendix 23 (3.2)(f)	Relocated	
9.9.7c.(7)	Appendix 23 (3.2)(g)	Relocated	
9.9.7d.	Appendix 23 (3.3)	Relocated	
9.9.7d.(1)	Appendix 23 (3.3)(a)	Relocated	
9.9.7d.(2)	Appendix 23 (3.3)(b)	Relocated	
9.9.7d.(3)	Appendix 23 (3.3)(c)	Relocated	
9.9.7d.(4)	Appendix 23 (3.3)(d)	Relocated	
9.9.7d.(5)	Appendix 23 (3.3)(e)	Relocated	
9.9.7e.	Appendix 23 (3.4)	Relocated	
9.9.7e.(1)	Appendix 23 (3.4)(a)(i)	Relocated	
9.9.7e.(2)	Appendix 23 (3.4)(a)(ii)	Relocated	
9.9.7e.(3)	Appendix 23 (3.4)(a)	Relocated	
9.9.7e.(4)	Appendix 23 (3.4)(c)	Relocated	
9.9.7e.(4)(a)	Appendix 23 (3.4)(c)(i)	Relocated	
9.9.7e.(4)(b)	Appendix 23 (3.4)(c)(ii)	Relocated	
9.9.7e.(4)(c)	Appendix 23 (3.4)(c)(iii)	Relocated	
9.9.7e.(4)(d)	Appendix 23 (3.4)(c)(iv)	Relocated	
9.9.7e.(4)(e)	Appendix 23 (3.4)(c)	Relocated	
9.9.7e.(4)(f)	Appendix 23 (3.4)(c)	Relocated	
9.9.7f.	Appendix 23 (3.5)	Relocated	
9.9.7f.(1)	Appendix 23 (3.5)(a)	Relocated	
9.9.7f.(2)	Appendix 23 (3.5)(b)	Relocated	
9.9.7f.(3)	Appendix 23 (3.5)(c)	Relocated	
9.9.7f.(4)	Appendix 23 (3.5)(d)	Relocated	
9.9.7f.(5)	Appendix 23 (3.5)(e)	Relocated	
9.9.7f.(6)	Appendix 23 (3.5)(f)	Relocated	
9.9.7f.(7)	Appendix 23 (3.5)(g)	Relocated	
9.9.7f.(8)	Appendix 23 (3.5)(h)	Relocated	
9.9.7g.	Appendix 23 (3.6)	Relocated	

Fire Code 2018	Fire Code 2013	Clause Status	Effective Date
Clause No.	Clause No.		
9.9.7g.(1)	Appendix 23 (3.6)(a)	Relocated	
9.9.7g.(2)	Appendix 23 (3.6)(b)	Relocated	
9.9.7g.(3)	Appendix 23 (3.6)(c)	Relocated	
9.9.7g.(4)	Appendix 23 (3.6)(d)	Relocated	
9.9.7h.	Appendix 23 (3.7)	Relocated	
9.9.7h.(1)	Appendix 23 (3.7)(a)	Relocated	
9.9.7h.(2)	Appendix 23 (3.7)(b)	Relocated	
9.9.7h.(3)	Appendix 23 (3.7)(c)	Relocated	
9.9.7i.	Appendix 23 (3.8)	Relocated	
9.9.7i.(1)	Appendix 23 (3.8)(a)	Relocated	
9.9.7i.(2)	Appendix 23 (3.8)(b)	Relocated	
9.9.7j.	Appendix 23 (3.9)	Relocated	
9.9.7j.(1)	Appendix 23 (3.9)(a)	Relocated	
9.9.7j.(1)(a)	Appendix 23 (3.9)(a)(i)	Relocated	
9.9.7j.(1)(b)	Appendix 23 (3.9)(a)(ii)	Relocated	
9.9.7j.(1)(c)	Appendix 23 (3.9)(a)(iii)	Relocated	
9.9.7j.(2)	Appendix 23 (3.9)(b)	Relocated	
9.9.7j.(3)	Appendix 23 (3.9)(c)	Relocated	
CHAPTER 10			
10.1	Appendix 13	Relocated	
10.1.1	Appendix 13 (1.1)	Relocated	
10.1.1a.	Appendix 13 (1.1)	Relocated	
10.1.1b.	Appendix 13 (2.1)	Relocated	
10.1.1c.	Appendix 13 (2.2)	Relocated	
10.1.1.d.	Appendix 13 (2.3)	Relocated	
10.1.1e.	Appendix 13 (2.4)	Relocated	
10.1.1e.(1)	Appendix 13 (2.4)	Relocated	
10.1.1e.(2)	Appendix 13 (2.4)	Relocated	
10.1.1e.(3)	Appendix 13 (2.4)	Relocated	
10.1.1e.(4)	Appendix 13 (2.4)	Relocated	
10.1.1e.(4)(a)	Appendix 13 (2.4)	Relocated	
10.1.1e.(4)(b)	Appendix 13 (2.4)	Relocated	
10.1.1e.(4)(c)	Appendix 13 (2.4)	Relocated	
10.1.1e.(4)(d)	Appendix 13 (2.4)	Relocated	
10.1.1e.(4)(e)	Appendix 13 (2.4)	Relocated	
10.1.1e.(4)(f)	Appendix 13 (2.4)	Relocated	
10.1.1e.(5)	Appendix 13 (3.1)	Relocated	
10.1.1e.(5)(a)	Appendix 13 (3.1)	Relocated	
10.1.1e.(5)(b)	Appendix 13 (3.1)	Relocated	
10.1.1e.(5)(c)	Appendix 13 (3.1)	Relocated	
10.1.1e.(5)(d)	Appendix 13 (3.1)	Relocated	
10.1.1e.(5)(e)	Appendix 13 (3.1)	Relocated	
10.1.2	Appendix 13 (3)	Relocated	
10.1.2a.	Appendix 13 (3.2)	Relocated	
10.1.2b.	Appendix 13 (3.3)	Relocated	
10.1.2c.	Appendix 13 (3.4)	Relocated	
10.1.2d.	Appendix 13 (3.5)	Relocated	
10.1.2e.	Appendix 13 (3.6)	Relocated	
10.1.2e.(1)	Appendix 13 (3.6.1)	Relocated	
10.1.2e.(2)	Appendix 13 (3.6.2)	Relocated	

Fire Code 2018	Fire Code 2013	Clause Status	Effective Date
Clause No.	Clause No.		
10.1.2e.(3)	Appendix 13 (3.6.3)	Relocated	
10.1.2e.(3)(a)	Appendix 13 (3.6.3)	Relocated	
10.1.2e.(3)(b)	Appendix 13 (3.6.3)	Relocated	
10.1.2e.(4)	Appendix 13 (3.6.3)	Relocated	
10.1.3	Appendix 13 (4)	Relocated	
10.1.3a.	Appendix 13 (4.1)	Relocated	
10.1.3a.(1)	Appendix 13 (4.1.1)	Relocated	
10.1.3a.(2)	Appendix 13 (4.1.2)	Relocated	
10.1.3a.(3)	Appendix 13 (4.1.3)	Relocated	
10.1.3a.(4)	Appendix 13 (4.1.4)	Relocated	
10.1.3a.(5)	Appendix 13 (4.1.5)	Relocated	
10.1.3a.(6)	Appendix 13 (4.1.6)	Relocated	
10.1.3a.(7)	Appendix 13 (4.1.7)	Relocated	
10.1.3a.(8)	Appendix 13 (4.1.8)	Relocated	
10.1.3a.(9)	Appendix 13 (4.1.9)	Relocated	
10.1.3b.	Appendix 13 (4.2)	Relocated	
10.1.3b.(1)	Appendix 13 (4.2.1)	Relocated	
10.1.3b.(2)	Appendix 13 (4.1.2)	Relocated	
10.1.3c.	Appendix 13 (4.3)	Relocated	
10.1.3c.(1)	Appendix 13 (4.3.1)	Relocated	
10.1.3c.(2)	Appendix 13 (4.3.2)	Relocated	
10.1.3c.(3)	Appendix 13 (4.3.3)	Relocated	
10.1.3c.(4)	Appendix 13 (4.3.4)	Relocated	
10.1.3c.(5)	Appendix 13 (4.3.5)	Relocated	
10.1.3c.(6)	Appendix 13 (4.3.6)	Relocated	
10.1.3c.(7)	Appendix 13 (4.3.7)	Relocated	
10.1.3d.	Appendix 13 (4.4)	Relocated	
10.1.3d.(1)	Appendix 13 (4.4.1)	Relocated	
10.1.3d.(1)(a)	Appendix 13 (4.4.1)	Relocated	
10.1.3d.(1)(b)	Appendix 13 (4.4.1)	Relocated	
10.1.3d.(1)(c)	Appendix 13 (4.4.1)	Relocated	
10.1.3d.(1)(d)	Appendix 13 (4.4.1)	Relocated	
10.1.3d.(2)	Appendix 13 (4.4.2)	Relocated	
10.1.3d.(2)(a)	Appendix 13 (4.4.2)	Relocated	
10.1.3d.(2)(b)	Appendix 13 (4.4.2)	Relocated	
10.1.4	Appendix 13 (5)	Relocated	
10.1.4a.	Appendix 13 (5.1)	Relocated	
10.1.4a.(1)	Appendix 13 (5.1.1)	Relocated	
10.1.4a.(2)	Appendix 13 (5.1.2)	Relocated	
10.1.4b.	Appendix 13 (5.2)	Relocated	
10.1.4b.(1)	Appendix 13 (5.2.1)	Relocated	
10.1.4b.(2)	Appendix 13 (5.2.2)	Relocated	
10.1.4b.(3)	Appendix 13 (5.2.3)	Relocated	
10.1.4b.(4)	Appendix 13 (5.2.4)	Relocated	
10.1.4b.(5)	Appendix 13 (5.2.5)	Relocated	
10.1.4b.(6)	Appendix 13 (5.2.6)	Relocated	
10.1.4b.(7)	Appendix 13 (5.2.7)	Relocated	
10.1.4b.(8)	Appendix 13 (5.2.8)	Relocated	
10.1.4b.(9)	Appendix 13 (5.2.9)	Relocated	
10.1.4c.	Appendix 13 (5.3)	Relocated	



Fire Code 2018	Fire Code 2013	Clause Status	Effective Date
Clause No.	Clause No.		
10.1.4c.(1)	Apendix 13 (5.3a.)	Relocated	
10.1.4c.(1)(a)	Apendix 13 (5.3a.(i))	Relocated	
10.1.4c.(1)(b)	Apendix 13 (5.3a.(ii))	Relocated	
10.1.4c.(1)(c)	Apendix 13 (5.3a.(iii))	Relocated	
10.1.4c.(2)	Apendix 13 (5.3b.)	Relocated	
10.1.4c.(2)(a)	Apendix 13 (5.3b.(i))	Relocated	
10.1.4c.(2)(b)	Apendix 13 (5.3b.(ii))	Relocated	
10.1.4c.(2)(c)	Apendix 13 (5.3b.(iii))	Relocated	
10.1.4c.(3)	Apendix 13 (5.3c.)	Relocated	
10.1.4c.(3)(a)	Apendix 13 (5.3c.(i))	Relocated	
10.1.4c.(3)(b)	Apendix 13 (5.3c.(ii))	Relocated	
10.1.4c.(3)(c)	Apendix 13 (5.3c.(iii))	Relocated	
10.1.4c.(3)(d)	Apendix 13 (5.3c.(iv))	Relocated	
10.1.4c.(3)(e)	Apendix 13 (5.3c.(v))	Relocated	
10.1.4d.	Apendix 13 (5.4)	Relocated	
10.1.4d.(1)	Apendix 13 (5.4a.)	Relocated	
10.1.4d.(1)(a)	Apendix 13 (5.4a.(i))	Relocated	
10.1.4d.(1)(b)	Apendix 13 (5.4a.(ii))	Relocated	
10.1.4d.(1)(c)	Apendix 13 (5.4a.(iii))	Relocated	
10.1.4d.(2)	Apendix 13 (5.4b.)	Relocated	
10.1.4d.(2)(a)	Apendix 13 (5.4b.(i))	Relocated	
10.1.4d.(2)(b)	Apendix 13 (5.4b.(ii))	Relocated	
10.1.4d.(2)(c)	Apendix 13 (5.4b.(iii))	Relocated	
10.1.4d.(2)(d)	Apendix 13 (5.4b.(iv))	Relocated	
10.1.4d.(2)(e)	Apendix 13 (5.4b.(iv))	Relocated	
10.1.4d.(2)(f)	Apendix 13 (5.4b.(v))	Relocated	
10.1.4d.(2)(g)	Apendix 13 (5.4b.(vi))	Relocated	
10.1.4d.(3)	Apendix 13 (5.4c.)	Relocated	
10.1.4d.(3)(a)	Apendix 13 (5.4c.(i))	Relocated	
10.1.4d.(3)(b)	Apendix 13 (5.4c.(ii))	Relocated	
10.1.4d.(3)(c)	Apendix 13 (5.4c.(iii))	Relocated	
10.1.4d.(4)	Apendix 13 (5.4d.)	Relocated	
10.1.4d.(4)(a)	Apendix 13 (5.4d.(i))	Relocated	
10.1.4d.(4)(b)	Apendix 13 (5.4d.(ii))	Relocated	
10.1.5	---	Extracted from circular dated 5 Jan 2018	05.01.2018
10.1.5a.	---	Extracted from circular dated 5 Jan 2018	05.01.2018
10.1.5b.	---	Extracted from circular dated 5 Jan 2018	05.01.2018
10.1.5c.	---	Extracted from circular dated 5 Jan 2018	05.01.2018
10.1.5d.	---	Extracted from circular dated 5 Jan 2018	05.01.2018
10.1.5e.	---	Extracted from circular dated 5 Jan 2018	05.01.2018
10.1.5f.	---	Extracted from circular dated 5 Jan 2018	05.01.2018
10.1.5g.	---	Extracted from circular dated 5 Jan 2018	05.01.2018
10.1.5h.	---	Extracted from circular dated 5 Jan 2018	05.01.2018
10.1.5i.	---	Extracted from circular dated 5 Jan 2018	05.01.2018
10.1.5j.	---	Extracted from circular dated 5 Jan 2018	05.01.2018
10.1.6	---	Extracted from circular dated 5 Jan 2018	05.01.2018
10.1.6a.	---	Extracted from circular dated 5 Jan 2018	05.01.2018
10.1.6a.(1)	---	Extracted from circular dated 5 Jan 2018	05.01.2018
10.1.6a.(2)	---	Extracted from circular dated 5 Jan 2018	05.01.2018
10.1.6a.(3)	---	Extracted from circular dated 5 Jan 2018	05.01.2018

Fire Code 2018	Fire Code 2013	Clause Status	Effective Date
Clause No.	Clause No.		
10.1.6a.(4)	---	Extracted from circular dated 5 Jan 2018	05.01.2018
10.1.6b.	---	Extracted from circular dated 5 Jan 2018	05.01.2018
10.1.6b.(1)	---	Extracted from circular dated 5 Jan 2018	05.01.2018
10.1.6b.(2)	---	Extracted from circular dated 5 Jan 2018	05.01.2018
10.1.6b.(3)	---	Extracted from circular dated 5 Jan 2018	05.01.2018
10.1.6b.(4)	---	Extracted from circular dated 5 Jan 2018	05.01.2018
10.1.6b.(5)	---	Extracted from circular dated 5 Jan 2018	05.01.2018
10.1.6b.(6)	---	Extracted from circular dated 5 Jan 2018	05.01.2018
10.2	---	Extracted from circular dated 31 Dec 2015	01.07.2016
10.2.1	---	Extracted from circular dated 31 Dec 2015	01.07.2016
10.2.2	---	Extracted from circular dated 31 Dec 2015	01.07.2016
10.2.2a.	---	Extracted from circular dated 31 Dec 2015	01.07.2016
10.2.2b.	---	Extracted from circular dated 31 Dec 2015	01.07.2016
10.2.2c.	---	Extracted from circular dated 31 Dec 2015	01.07.2016
10.2.2d.	---	Extracted from circular dated 31 Dec 2015	01.07.2016
10.2.3	---	Extracted from circular dated 31 Dec 2015	01.07.2016
10.2.3a.	---	Extracted from circular dated 31 Dec 2015	01.07.2016
10.2.3b.	---	Extracted from circular dated 31 Dec 2015	01.07.2016
10.2.4	---	Extracted from circular dated 31 Dec 2015	01.07.2016
10.2.4a.	---	Extracted from circular dated 31 Dec 2015	01.07.2016
10.2.4b.	---	Extracted from circular dated 31 Dec 2015	01.07.2016
10.2.4c.	---	Extracted from circular dated 31 Dec 2015	01.07.2016
10.2.4d.	---	Extracted from circular dated 31 Dec 2015	01.07.2016
10.2.4e.	---	Extracted from circular dated 31 Dec 2015	01.07.2016
10.2.4f.	---	Extracted from circular dated 31 Dec 2015	01.07.2016
10.2.5	---	Extracted from circular dated 31 Dec 2015	01.07.2016
10.2.5a.	---	Extracted from circular dated 31 Dec 2015	01.07.2016
10.2.5b.	---	Extracted from circular dated 31 Dec 2015	01.07.2016
10.2.5c.	---	Extracted from circular dated 31 Dec 2015	01.07.2016
CHAPTER 11			
11.1	Appendix 15 (1)	Relocated, rephrased	
11.2	---	---	
11.2.1	---	New	01.03.2019
11.2.2	---	New	01.03.2019
11.2.3	---	New	01.03.2019
11.2.4	---	New	01.03.2019
11.2.5	Appendix 15 (3)	Relocated	
11.2.6	Appendix 15 (3)	Relocated	
11.2.7	Appendix 15 (3)	Relocated	
11.2.8	---	New	01.03.2019
11.2.9	---	New	01.03.2019
11.3	---	---	
11.3.1	Appendix 15 (4)	Relocated	
11.3.1a.	Appendix 15 (4)	Relocated	
11.3.1b.	Appendix 15 (4)	Relocated	
11.3.2	---	---	
11.3.2a.	---	Extracted from circular dated 6 Feb 2017	06.02.2017
11.3.2b.	---	Extracted from circular dated 6 Feb 2017	06.02.2017
11.3.2c.	---	New	01.03.2019
11.3.3	---	---	



Fire Code 2018	Fire Code 2013	Clause Status	Effective Date
Clause No.	Clause No.		
11.3.3a.	---	Extracted from circular dated 6 Feb 2017	06.02.2017
11.3.3b.	---	New	01.03.2019
11.3.3c.	---	New	01.03.2019
11.3.3d.	---	New	01.03.2019

GUIDE ON THE USE OF INTERACTIVE FEATURES



1. RATIONALE OF CLAUSE

- a) To view : roll mouse over the Rationale icon 
- b) To close : roll mouse off the Rationale icon 



2. EXPLANATION AND ILLUSTRATION

- a) To view : click the Explanation & Illustration icon 
- b) To close : click the Close icon  on the top right-hand corner or click anywhere within the popup panel



3. NOTE

- a) To view : roll mouse over the Note icon 
- b) To close : roll mouse off the Note icon 



4. CLAUSE HISTORY

- a) To view : roll mouse over the History bar 
- b) To close : roll mouse off the History bar 



5. DIAGRAM

- a) To view : click and release the diagram label, e.g. *Diagram 6.2.5a.(3)*
- b) To return : hold down the  key and press the back  key

6. TABLE

- a) To view : click and release the table label, e.g. *Table 3.9A*
- b) To return : hold down the  key and press the back  key

7. CLAUSE CROSS-REFERENCE

- a) To view : click the clause link label, e.g. *Cl.2.5.6*
- b) To return : hold down the  key and press the back  key

8. CLAUSE NAVIGATION

- a) Go to the CONTENTS page
- b) Click on the required heading

9. PAGE NAVIGATION

a) **To go to next page spread**

Click on the Next Page button  or use mouse scroll wheel to go the next page spread

b) **To go back to preceding page spread**

Click on the Previous Page button  or use mouse scroll wheel to go the previous page spread

c) **To go to next Chapter**

Click on the Next Page button  or use mouse scroll wheel to go the next page spread



d) **To go back to preceding Chapter**

Click on the Previous Page button  or use mouse scroll wheel to go the previous page spread

e) **To go to Contents page**

Click on the Contents button 

f) **To return to last active page**

Hold down the  key and press the back  key



**HQ Singapore Civil Defence Force
91 Ubi Avenue 4, Singapore 408827**

