

# CHAPTER 1

## 1.1 GENERAL

The code serves to establish the minimum requirements for fire safety provisions. It takes into account the function, design, management, operation, and maintenance of buildings to secure the life safety of occupants in the event of a fire.

This chapter lists the Appendixes for specific buildings or usage and the definitions of the commonly used terms in the code.

### 1.1.1 Building Designated For Conservation

Buildings including shophouses, which are designated for conservation under the Urban Redevelopment Authority's (URA) conservation programme shall comply with the set of documents on "Fire Safety Requirements affecting shophouses under Conservation" issued by URA on 28 Jul 93 under Circular No URA/PB/93/20-CUDD. Please see Appendix (1).

### EXPLANATIONS & ILLUSTRATIONS

*To assist URA in their programme on conservation of old shophouses in the early 1990s, a set of fire safety guidelines was jointly drawn up by URA/FSSB, and issued by URA on 28 July 1993. To apply the safety requirements from the existing fire code would mean that timber floors and timber staircases could not be retained. Hence, a separate set of fire safety guidelines was considered necessary.*

*Thus it was agreed that timber floors and staircases could be retained, but the timber floors are to be upgraded to have minimum half hour fire resistance rating and that the timber staircases are required to be made protected at the 1<sup>st</sup> and upper storey, and shall be made to discharge into the five footway or rear backlane.*

*For shophouses that have timber floors and timber staircases, there shall be no change of use to boarding houses, hotels, workers' quarters and the like because of the sleeping risk involved. Partial upgrading of building is considered not acceptable.*

*For shophouses which are not designated by URA for conservation, there is no incentive for the building owners to upgrade their buildings to have proper fire protection to the timber floors and the timber staircases. These shophouses would be considered as fire hazard.*

*FSSD did a survey on old shophouses and decided that the above relaxation on compliance of fire safety requirements given to shophouses under conservation should be extended to old shophouses that existed before 1969. The relaxation would provide incentive for building owners to renovate their old shophouse to comply with the set of fire safety guidelines issued by URA, instead of having to change all the timber floors/staircases to non-combustible materials to comply with the current fire code.*

# CHAPTER 1

## 1.1 GENERAL

### 1.1.1.2 Building Designated For Conservation

The “Fire Safety Requirements affecting shophouses under Conservation” shall also be applicable to old shophouses, including residential buildings (except temporary dwelling houses), having timber floors or staircases, whether designated or not for conservation by URA, subject to the following conditions:

- (a) The above relaxation shall be applicable to buildings that were existing before 1969;
- (b) There shall be no change of use to boarding houses, hotels, workers’ quarters and the like, irrespective whether the building is under conservation or not; and
- (c) The upgrading of fire safety works shall be applicable to the whole building; partial upgrading of building is not acceptable.

### EXPLANATIONS & ILLUSTRATIONS

*The relaxation in the use of timber staircase / flooring is only applicable if the staircase or flooring is constructed of timber material. Note that QP has to upgrade the whole building to comply with the fire safety requirements stipulated in the conservation guidelines. Partial upgrading involving only the floor involved in the A/A works is not allowed.*

# CHAPTER 1

## 1.1 GENERAL

<b>1.1.2 Rapid Transit System</b>	
<p>Fire safety requirements for underground, surface and elevated rapid transit systems, including trainways, transit stations, train maintenance depots, on-line electric substations and rapid transit system facility buildings, shall comply with the circular on “Standard for Fire Safety in Rapid transit Systems” issued by FSB (now FSSD) on 5 Sep 2000.</p>	
<b>EXPLANATIONS &amp; ILLUSTRATIONS</b>	
<p><i>No illustration.</i></p>	

# CHAPTER 1

## 1.1 GENERAL

<b>1.1.3 Fire Safety Requirements in Temporary Buildings on Construction Sites</b>	
<p>All temporary structures/buildings including site offices or housing quarters on construction sites shall comply with SS 547 Code Of Practice For Temporary Housing Quarters On Construction Sites.</p> <p>Although submission of plans to SCDF (FSSD) is not required, a set of plans of the temporary buildings, duly endorsed by a Qualified Person (QP), shall be available on site for inspection by the Relevant Authority at all times. Please note that Regulation 42 of the Fire Safety (Building Fire Safety) Regulations allows the building industry to self-regulate the fire safety works in temporary buildings on construction sites.</p>	
<b>EXPLANATIONS &amp; ILLUSTRATIONS</b>	
<p><i>No illustration.</i></p>	

# CHAPTER 1

## 1.1 GENERAL

<b>1.1.4 Fire Safety Requirements For Chemical/Hazmat Warehouses</b>	
<p>Chemicals or hazardous materials (hazmat) have a wide range of properties and hazards which must be identified and understood if the conditions of “safe warehousing” are to be achieved. A complete understanding of the hazards also requires an assessment of the container and packaging systems and storage arrangements. In addition, the provision of “Guidelines on Fire Safety Requirements for General Warehouses” shall be complied with. See Appendix (2).</p>	
<b>EXPLANATIONS &amp; ILLUSTRATIONS</b>	
<p><i>No illustration.</i></p>	

# CHAPTER 1

## 1.1 GENERAL

<b>1.1.5 Fire Safety Requirements for Buildings Under Construction</b>	
<p>Currently, there are two types of rising mains required in our buildings ie. Dry riser for buildings between 10m to 60m in habitable height and wet riser for buildings above 60m in habitable height. Where a building is required to have the provision of rising mains, all rising mains (either dry or wet riser) shall be designed and installed while the building is under construction. The technical guidelines on the provision of rising mains for buildings under construction are given in Appendix (3).</p>	
<b>EXPLANATIONS &amp; ILLUSTRATIONS</b>	
<p><i>No illustration.</i></p>	

# CHAPTER 1

## 1.1 GENERAL

<b>1.1.6 Fire Safety Requirements For General Warehouses</b>	
<p>The scope of these guidelines covers the fire safety requirements for general warehouses which include single-storey single-user warehouses, single-storey multi-user warehouses, underground warehouses, multi-storey warehouses with or without basements and warehouse within other non-industrial buildings. These Guidelines shall supersede the “Guidelines on Fire Safety Requirements for Mega Warehouse. A new set of requirements is drawn up at Appendix (4).</p>	
<b>EXPLANATIONS &amp; ILLUSTRATIONS</b>	
<p><i>No illustration.</i></p>	

# CHAPTER 1

## 1.1 GENERAL

<b>1.1.7 Fire Safety Requirements For Fully Automated Mechanised Car Park (FAMCP)</b>	
<p>The fully automated mechanised car park buildings, which can be above and/or below ground, incorporate the revolutionary concept of parking and retrieving a vehicle by mechanical means without the driver entering the parking area. The buildings are therefore unmanned and are totally different from the conventional car parks, such as, car park in a multi-storey building, multi-storey car parks, etc. In view of the peculiar designs and operations of the fully automated mechanised car parks, a new set of requirements is drawn up at Appendix (5) for ease of reference and compliance.</p>	
<b>EXPLANATIONS &amp; ILLUSTRATIONS</b>	
<p><i>No illustration.</i></p>	



# CHAPTER 1

## 1.1 GENERAL

<b>1.1.8 Notes On The Use Of Intumescent Paints For Protection To Structural Steel Members Of Buildings.</b>	
A new set of requirements is drawn up at Appendix (6) for ease of reference and compliance.	
<b>EXPLANATIONS &amp; ILLUSTRATIONS</b>	
<i>No illustration.</i>	

# CHAPTER 1

## 1.1 GENERAL

<b>1.1.9 Structural Loading of Fire Engine on Accessway</b>	
Technical data on fire appliance is drawn up at Appendix (7) for ease of reference and compliance.	
<b>EXPLANATIONS &amp; ILLUSTRATIONS</b>	
<i>No illustration.</i>	

# CHAPTER 1

## 1.1 GENERAL

<b>1.1.10 Additional Fire Safety Requirements For Super High-rise Residential Building</b>	
<p>With the continuous growth of Singapore’s population, high demand for residential properties, and the limited land space of this island nation, urban planners and designers are pushing the limits in building height upwards. Such a trend has begun to emerge even in our public residential development programme. Residential buildings that go beyond 40 storeys shall be labeled as Super High-rise Buildings. In view of greater fire safety concerns associated with taller residential buildings such as higher complexities faced by emergency responders in fire-fighting and rescue efforts as well as evacuation of the occupants, a new set of requirement is drawn up in Appendix (8) for ease of compliance and reference.</p>	
<b>EXPLANATIONS &amp; ILLUSTRATIONS</b>	
<p><i>No illustration.</i></p>	

# CHAPTER 1

## 1.1 GENERAL

<b>1.1.11 Water Supply Requirements For Wet Riser System</b>	
<p>Current pumping and storage capacities as stipulated in SS 575 can be reduced, on account that buildings having wet risers are likely to be sprinkler protected and the number of fire hose jets likely to be deployed at the fire site. The reduction in water supply requirements would result in less space requirements and thus impose smaller loads on the building structure. See Appendix (9) for ease of compliance and reference.</p>	
<b>EXPLANATIONS &amp; ILLUSTRATIONS</b>	
<p><i>No illustration.</i></p>	

# CHAPTER 1

## 1.1 GENERAL

<b>1.1.12 Fire Safety Requirements For Petroleum Service Station</b>	
<p>The requirements for storing and dispensing of liquid petroleum in Petroleum Service Station, as defined under the Petroleum Regulations (Fire Safety Act), are drawn up at Appendix (10). Its purpose is not intended to preclude the use of alternative designs, materials and methods that provide equivalent standards of safety. Petroleum Service Stations are installations where petrol and diesel are kept and dispensed as fuel for motor vehicles, on forecourt areas, which members of the public have access to.</p> <p>Measures and provisions must be made to prevent ignition sources coming into contact with liquid petroleum or its vapour. The control of ignition sources may become more difficult on sites where the public have access. This would cause the risk to life and property to be potentially high, especially where there are activities apart from dispensing petrol or where supervision is not constant.</p>	
<b>EXPLANATIONS &amp; ILLUSTRATIONS</b>	
<p><i>No illustration.</i></p>	

# CHAPTER 1

## 1.1 GENERAL

<b>1.1.13 Reduced Water Storage Requirements For Sprinkler systems in Buildings (for Ordinary Hazard Groups)</b>	
<p>The primary purpose of these guidelines is to facilitate the installation of sprinkler systems in existing buildings that are not already protected by sprinkler system and that are in the Ordinary Hazard I, II &amp; III classification. They are also applicable to new buildings having similar hazards. With the timely response by the SCDF, the designated water storage capacities in these guidelines should be adequate for the sprinkler system to control the fire spread till the arrival and the intervention by fire fighters. See Appendix (11).</p>	
<b>EXPLANATIONS &amp; ILLUSTRATIONS</b>	
<p><i>No illustration.</i></p>	

# CHAPTER 1

## 1.1 GENERAL

<b>1.1.14 Fire Safety Requirements For High Containment Facility (BIO- Safety Level 3 / 4)</b>	
<p>The purpose of these guidelines is to stipulate the fire safety requirements for high containment facility or laboratory that handles biological agents or toxins, designed to meet the WHO and MOH's requirements of Bio-Safety Level 3 [BSL-3] or higher level facility. These guidelines will assist the Qualified Persons in the design of fire safety provisions for the high containment facility. See Appendix (12)</p>	
<b>EXPLANATIONS &amp; ILLUSTRATIONS</b>	
<p><i>No illustration.</i></p>	

# CHAPTER 1

## 1.1 GENERAL

<b>1.1.15 Fire Safety Requirements For Liquefied Petroleum Gas (LPG) Cylinder Installations</b>	
---	--

<p>The scope of these guidelines covers both outdoor and indoor LPG cylinder installations. It is intended for commercial, industrial and residential premises with eating outlets, eating places, canteens, restaurants and other eateries which use LPG for cooking purposes. It is also intended for industrial applications involving hot works. See Appendix (13)</p>	
--	--

<b>EXPLANATIONS &amp; ILLUSTRATIONS</b>	
---	--

*No illustration.*



# CHAPTER 1

## 1.1 GENERAL

<b>1.1.16 Fire Safety Requirements For Laboratories Handling Hazardous Chemicals</b>	
For laboratory storing and using chemicals/hazmat shall be in compliance with NFPA 45 (with the Maximum Allowable Quantity, MAQ, being modified; you may refer to SCDF's Web-site for more comprehensive details).	
<b>EXPLANATIONS &amp; ILLUSTRATIONS</b>	
<i>No illustration.</i>	

# CHAPTER 1

## 1.1 GENERAL

### **1.1.17 Water Supply Requirements For Sprinkler And Wet Riser Systems in High-rise Buildings**

These requirements serve to facilitate the installation of combined storage and pumping facilities for fire-fighting systems in high-rise buildings which would result in less space requirements, smaller loads imposed on the building structure and less cost in maintaining the system. The wet riser storage tank is able to cater to the effective operation of both sprinkler and wet riser systems, taking into consideration the response time of SCDF's fire fighting crew to fire incidents and standard operations procedures at fire site. See Appendix (14)

### **EXPLANATIONS & ILLUSTRATIONS**

*No illustration.*

# CHAPTER 1

## 1.1 GENERAL

<b>1.1.18 Certification of Regulated Fire Safety Products/Materials</b>	
<p>Since the privatisation of PSB in April 2006, SCDF has been working with the Singapore Accreditation Council (SAC), the national agency for accreditation of conformity assessment bodies which operates under the aegis of the SPRING Singapore, for the purpose of opening up the Product Certification to other qualified certification bodies. See Appendix (15).</p>	
<b>EXPLANATIONS &amp; ILLUSTRATIONS</b>	
<p><i>No illustration.</i></p>	

# CHAPTER 1

## 1.1 GENERAL

<b>1.1.19 Fire Safety Requirements For Temporary Workers' Quarters in Uncompleted Permanent Buildings on Construction Sites</b>	
<p>The scope of this Fire Safety Requirements (FSR) comprises the design, construction, installation and maintenance of temporary workers' quarters in uncompleted buildings on construction sites. It includes fire safety plans submission for such workers' quarters. This FSR shall not be applicable if the aggregate number of workers housed in the temporary workers' quarters in the uncompleted permanent building(s) on the construction site is not more than 40. See Appendix (16).</p>	
<b>EXPLANATIONS &amp; ILLUSTRATIONS</b>	
<p><i>No illustration.</i></p>	

# CHAPTER 1

## 1.1 GENERAL

<b>1.1.20 Fire Safety Requirements For Ductless Jet Fans System In Car Parks</b>	
<p>This set of requirements is only applicable to conventional car parks where passenger cars/light weight vehicles are parked alongside each other with common driveways and is not intended for mechanized car park system or other forms of car parking systems. See Appendix (17).</p>	
<b>EXPLANATIONS &amp; ILLUSTRATIONS</b>	
<p><i>No illustration.</i></p>	

# CHAPTER 1

## 1.1 GENERAL

<b>1.1.21 Fire Safety Requirements For Determination Of Design Fires For Industrial Premises</b>	
<p>This set of requirements is only applicable to sprinklered industrial premises (factory and warehouse) without in-rack sprinklers and limited to the design of smoke control system based on cl.7.6 of the Fire Code (i.e. prescriptive-based approach). See Appendix (18).</p>	
<b>EXPLANATIONS &amp; ILLUSTRATIONS</b>	
<p><i>No illustration.</i></p>	

# CHAPTER 1

## 1.1 GENERAL

### 1.1.22 Fire Safety Requirements For Lift Rescue

This set of Fire Safety Requirements (FSR) stipulates the fire safety provisions for performing lift rescue operation in buildings with blind lift hoist ways exceeding 11m. The fire safety requirements stipulated herein shall be applicable to buildings of all purpose groups except purpose group I. See Appendix (19)

### EXPLANATIONS & ILLUSTRATIONS

*No illustration.*

# CHAPTER 1

## 1.1 GENERAL

<b>1.1.23 Fire Safety Requirements For Persons With Disabilities</b>	
<p>The scope of these requirements covers the provision of fire safety features to assist persons with disabilities (PWDs) during emergencies and the development of plans to manage the evacuation of PWDs. It shall be applicable to all buildings except Purpose Group I and II buildings (residential) and Health Care Occupancy (i.e. Hospital, Nursing Home, Ambulatory Health Care Centre, Custodian Care and Supervisory Care facility) as defined in the Fire Code. Non-residential standalone buildings such as carpark buildings and clubhouses that are located within the residential development and intended as ancillary use are not required to comply with these requirements. See Appendix (20).</p>	
<b>EXPLANATIONS &amp; ILLUSTRATIONS</b>	
<p><i>No illustration.</i></p>	



# CHAPTER 1

## 1.1 GENERAL

<b>1.1.24 Fire Safety Requirements on Using Lifts For Evacuation of Building Occupants During Emergency</b>	
<p>The scope of these requirements covers the provision of lift design for evacuation of building occupants requiring assistance during emergencies. It shall be applicable to all buildings exceeding 24m except Purpose Group I and II buildings (residential developments) as defined in the Fire Code. See Appendix (21).</p>	
<b>EXPLANATIONS &amp; ILLUSTRATIONS</b>	
<p><i>No illustration.</i></p>	

# CHAPTER 1

## 1.1 GENERAL

<b>1.1.25 Review on Use of Hydrocarbon Refrigerant in Singapore</b>	
<p>With the rising awareness of environmental concern, Hydrocarbon (HC) refrigerant is seen by some as a suitable replacement for the less environmentally friendly refrigerants, which will be phased out under the Montreal Protocol. Although the use of HC refrigerant is deemed to be environmentally friendly and results in possible cost savings from better energy efficiency, it is extremely flammable and has its inherent fire safety risks. See Appendix (22).</p>	
<b>EXPLANATIONS &amp; ILLUSTRATIONS</b>	
<p><i>No illustration.</i></p>	

# CHAPTER 1

## 1.1 GENERAL

<b>1.1.26 Fire Safety Requirements For Mega Underground Developments</b>	
<p>This guideline provides the broad fire safety requirements for mega underground developments. It is applicable to mega underground developments regardless of size and no. of occupants. Fire safety requirements not covered in this guideline shall comply with the requirements stipulated in the Fire Code. See Appendix (23).</p>	
<b>EXPLANATIONS &amp; ILLUSTRATIONS</b>	
<p><i>No illustration.</i></p>	

# CHAPTER 1

## 1.1 GENERAL

<b>1.1.27 Provision of Exit and Directional Signs in Buildings</b>	
<p>Entrance to every exit on every floor shall be clearly indicated by an exit sign placed over the exit doors. In long corridors, open floor areas, and all situations where the location of the exits may not be readily visible, directional signs shall be provided to serve as guides from all portions of the corridors or floors. Room shall also be provided with exit sign. Appendix (24) provides the guidelines for rooms that require the provision of exit signs.</p>	
<b>EXPLANATIONS &amp; ILLUSTRATIONS</b>	
<p><i>No illustration.</i></p>	

# CHAPTER 1

## 1.2 DEFINITIONS

### 1.2.1 Abbreviation

The abbreviations listed in the following table are used in this Code:-

Abbreviation	Definition
† BS	British Standard
† CP	Code of Practice
Cl.	Clause
† NFPA	National Fire Protection Association
† AS	Australian Standard
† ISO	International Organisation For Standardisation
† SS	Singapore Standard
† ASTM	ASTM International
† EN	European Norm

† Latest version shall be used.

### EXPLANATIONS & ILLUSTRATIONS

*The latest version of the Code of Practice or Standard shall be used. The Fire Code frequently makes reference to the various Codes of practice published by SPRING Singapore.*

*For ease of implementation, the years in which the Codes of Practice are published have been omitted from the Fire Code. Any reference to a Code of Practice refers to the latest version.*

# CHAPTER 1

## 1.2 DEFINITIONS

### 1.2.1A Air-well

An air-well is a space(s) enclosed substantially by building(s) and directly open to the sky.

Table 1.2.1A  
Minimum Air-well size

Max. Habitable Height of Building	Min. Clear width of Air-well
18m	10m
24m	11m
36m	12m
48m	13m
60m and above	14m

### EXPLANATIONS & ILLUSTRATIONS

*The minimum air-well size specification in Table 1.2.1A is intended for exit staircase ventilation via an external space that is within an air-well situation. To qualify as external space, the air-well size shall comply with Table 1.2.1A and air-well shall be devoid of any overhead obstruction such as trellis over the air-well as it may have an adverse effect on smoke ventilation.*

*Readers should not confuse the ventilation requirements for smoke-stop lobby with that for exit staircase where the air-well size differs. To qualify as external space under sub-clause 2.2.13, the air-well size shall have minimum width 6m and a superficial plan area of not less than 93sqm. However, in the case of exit staircase ventilation via an air-well, the minimum clear width of the air-well is 10m.*

# CHAPTER 1

## 1.2 DEFINITIONS

<b>1.2.2 Approved</b>	
"Approved" means approved by the Relevant Authority	
<b>EXPLANATIONS &amp; ILLUSTRATIONS</b>	
<i>No illustration.</i>	

# CHAPTER 1

## 1.2 DEFINITIONS

<b>1.2.2(A) Ancillary office</b>	
<p>Any office which supports the activities of another Purpose Groups III, V, VI, VII and VIII and is located within the same building or compartment as the purpose group it serves is termed as ancillary office. Any office which supports the activities of another Purpose Groups III, V, VI, VII and VIII and is located within the same building or compartment as the purpose group it serves is termed as ancillary office</p>	
<b>EXPLANATIONS &amp; ILLUSTRATIONS</b>	
<p><i>No illustration.</i></p>	



# CHAPTER 1

## 1.2 DEFINITIONS

### 1.2.2(B) Ancillary usage

- (a) The ancillary office, sick room/first aid room, reception lobby/area, waiting area, staff lounge/staff recreation room, staff rest room/pantry, staff changing/locker room, meeting room, staff training room etc are considered as ancillary use and part of the same purpose group.
- (b) In addition, workshop, laboratories (no open flame), store room, material/product holding area and packing/distribution area housed within factory or warehouse buildings are also considered as ancillary use

### EXPLANATIONS & ILLUSTRATIONS

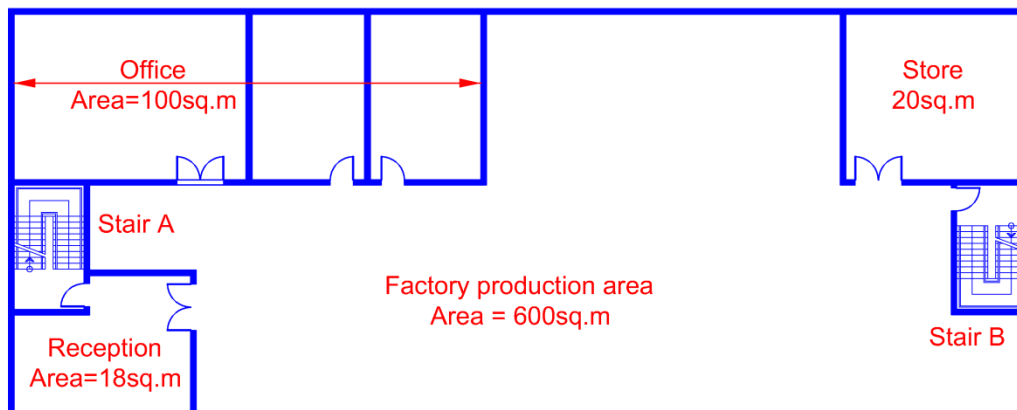

Diagram 1.2.2(B)

*The office is “supporting” the activities at the factory production area. If the office is rented to other tenant & having activities that is not supporting the activities at the production area, it is not considered as ancillary office.*

# CHAPTER 1

## 1.2 DEFINITIONS

### 1.2.3 Area of Building

- (a) The area of any storey of a building or compartment shall be taken to be the total area of that storey bounded by the inner finished surfaces of the enclosing walls or, on any side where there is no enclosing walls, by the outermost edge of the floor on that side.

### EXPLANATIONS & ILLUSTRATIONS

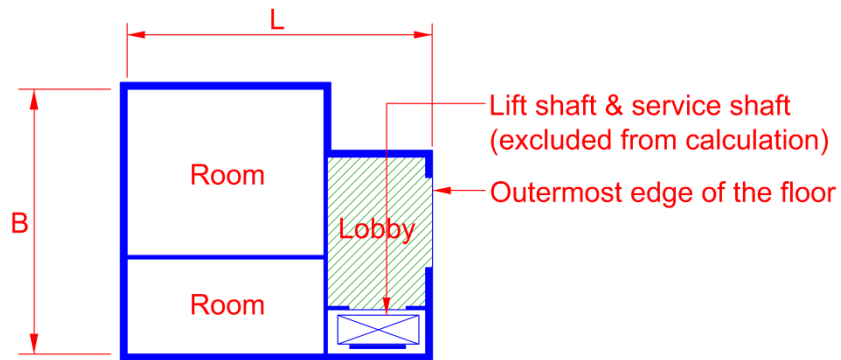

Diagram 1.2.3(a)

*Measured to inner finished surface of enclosing wall or where there is no enclosing wall, the outermost edge of floor. The area of the floor shall exclude the lift shaft and service shaft.*

(b) The area of any room or space shall be taken to be the total area of its floor bounded by the inner finished surfaces of the walls forming the room or space.

**EXPLANTIONS & ILLUSTRATIONS**

**1.2.3**

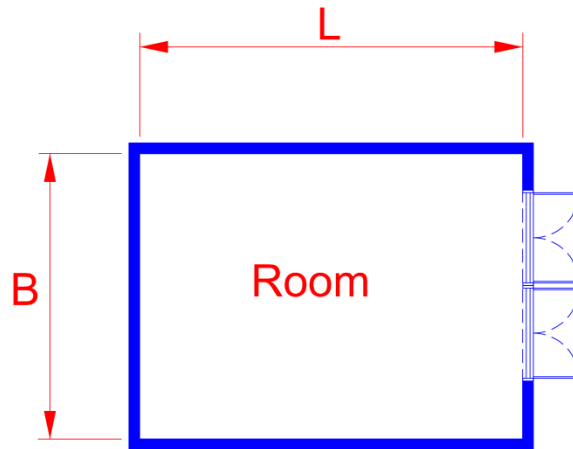

*Measurement of area of room*

*Diagram 1.2.3(b)-1*

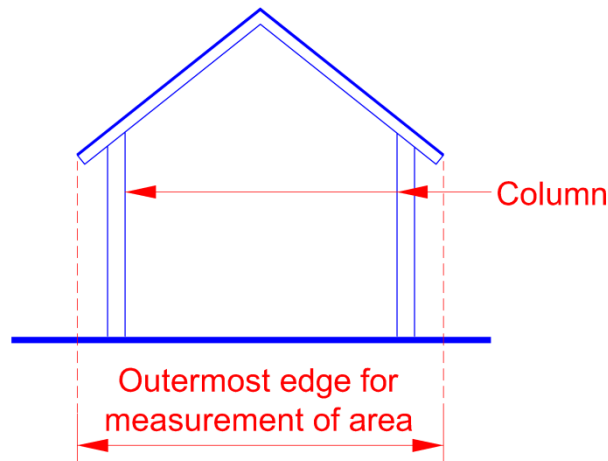

*Measurement of area for building without external wall*

*Diagram 1.2.3(b)-2*

(c) The area of any part of a roof shall be taken to be the actual visible area of such part measured on a plane parallel to the pitch of the roof.

**EXPLANTIONS & ILLUSTRATIONS**

**1.2.3**

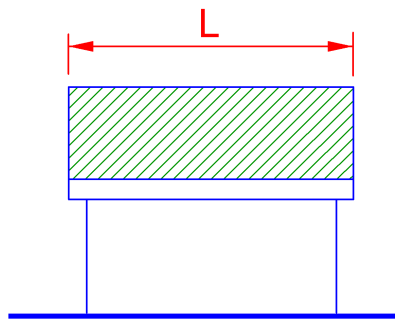

Elevation view

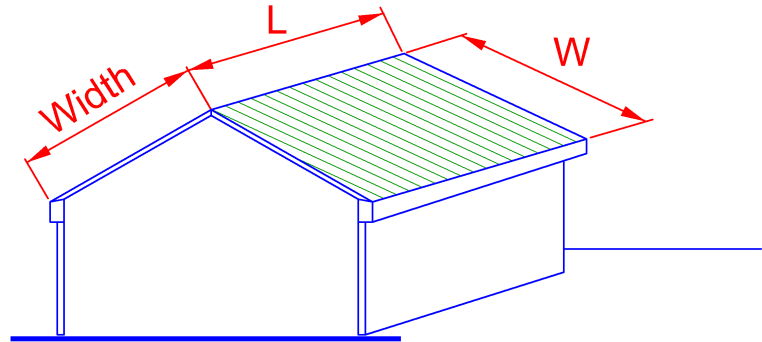

Sectional view

Area of roof =  $2(L \times W)$

*Diagram 1.2.3(c)*

# CHAPTER 1

## 1.2 DEFINITIONS

### 1.2.4 Area of refuge

- (a) In the building under consideration, an area of refuge is an area adequately separated from the rest of the building by fire resisting construction (see Cl.3.3 for details), and evacuees from the rest of the building enter the area of refuge using an external corridor that links this area to the rest of the building. An area of refuge may serve as required exit in lieu of the provisions given under Cl.1.2.24.
- (b) An area of refuge may also be an area in an adjoining building which is separated from the building under consideration by fire resisting construction and evacuees similarly enter this area of refuge using an external corridor.
- (c) An area of refuge shall always be accessible.

### EXPLANATIONS & ILLUSTRATIONS

- i) For building A to qualify for reduction in the provision of exits, adjoining building B must act as an area of refuge

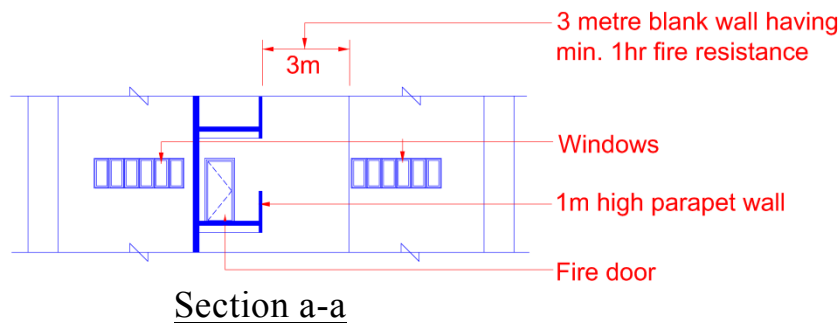
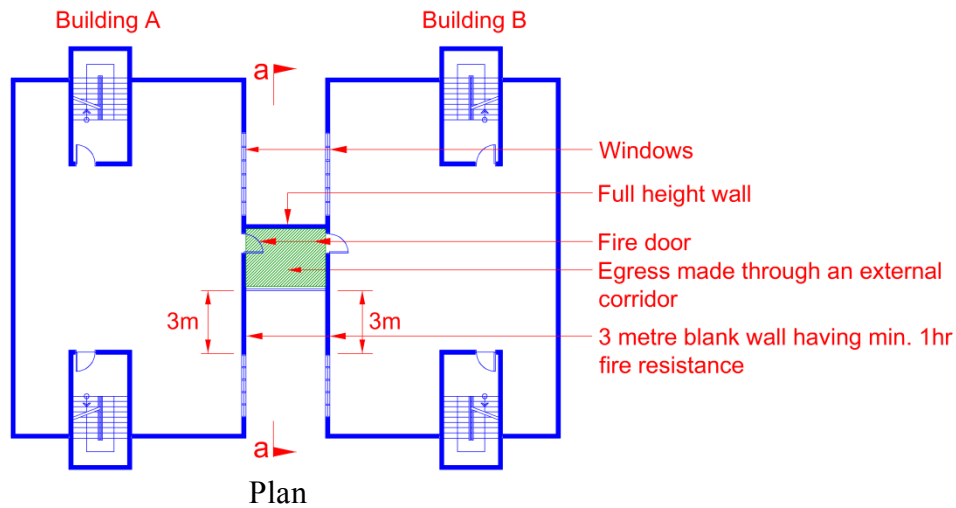
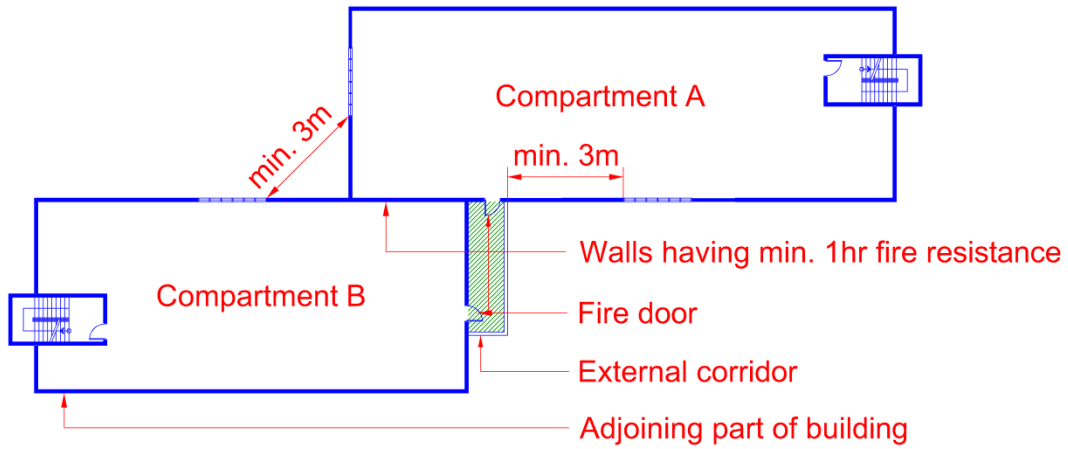

Diagram 1.2.4 – 1

ii) *An area in an adjoining part of the same building may act as an area of refuge*



Plan

Diagram 1.2.4 – 2

*The area of refuge is a temporary holding area. Hence the staircases provided need not be designed to accommodate all the people that will occupy the area of refuge in case of emergency.*

iii) *It is acceptable for compartment B to act as an area of refuge for compartment A or vice versa as the access is through an open sided corridor*

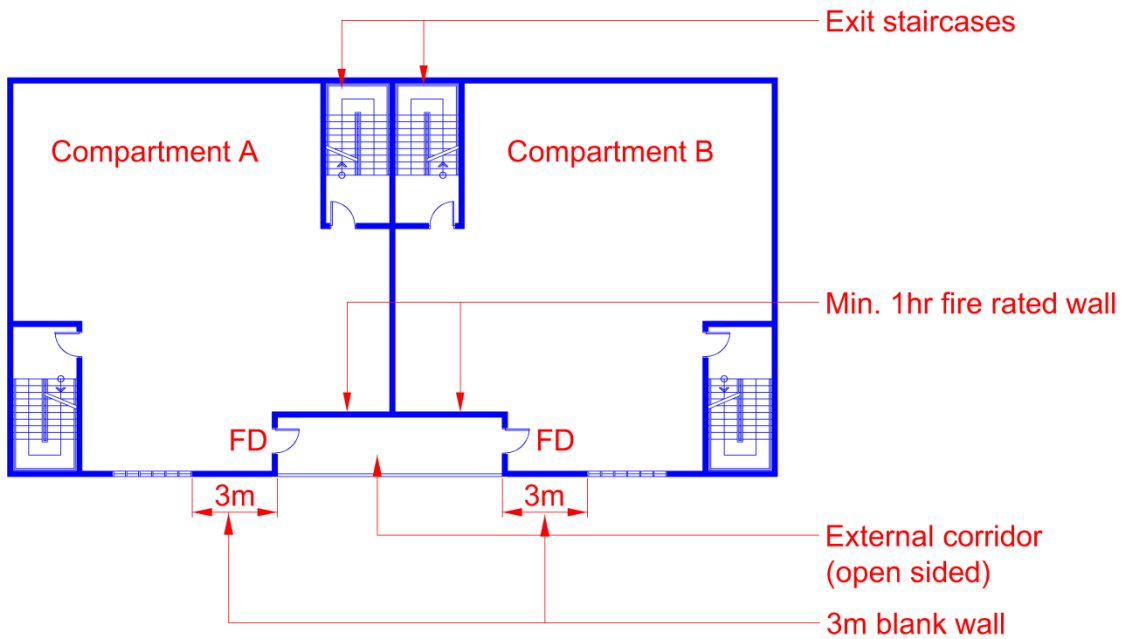

Plan

Diagram 1.2.4 – 3

- iv) *Compartment B is acting as an area of refuge to compartment A which is not meeting the intent of the fire code, hence not acceptable*

***Not Acceptable Proposal***

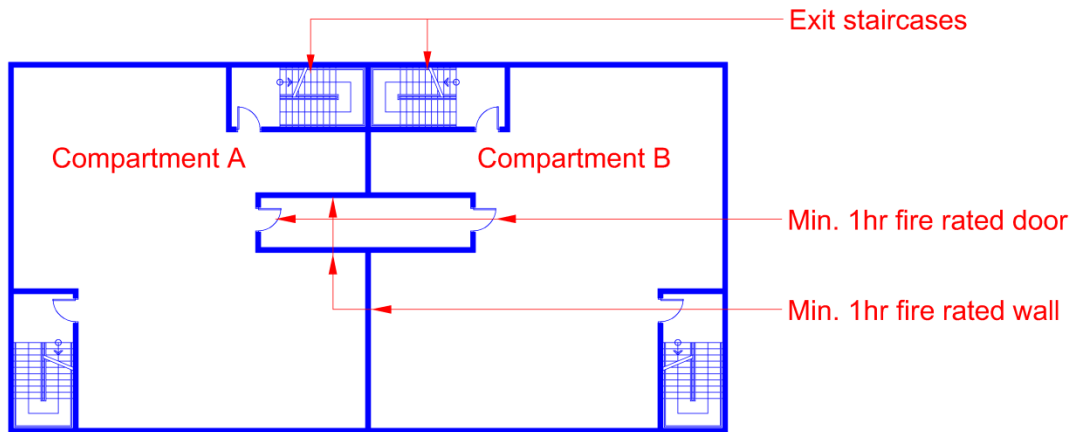

Plan

*Diagram 1.2.4 – 4*

*Note : It is critical that the area of refuge shall be accessible to evacuees in times of emergency. Where there is doubt that evacuees would not be able to gain access to the area of refuge owing to locking of doors and different tenancies, the concept of area of refuge would not work.*

# CHAPTER 1

## 1.2 DEFINITIONS

### 1.2.5 Atrium

An atrium within a building is a large open space created by an opening, or a series of openings, in floor assemblies, thus connecting two or more storeys. Atrium is covered at the top and is used for purposes other than those associated with small shafts, such as for stairs, elevators and various services. The sides of the atrium may be open to all floors, to some of the floors, or closed to all or some floors by unrated or rated fire-resistance construction.

### EXPLANATIONS & ILLUSTRATIONS

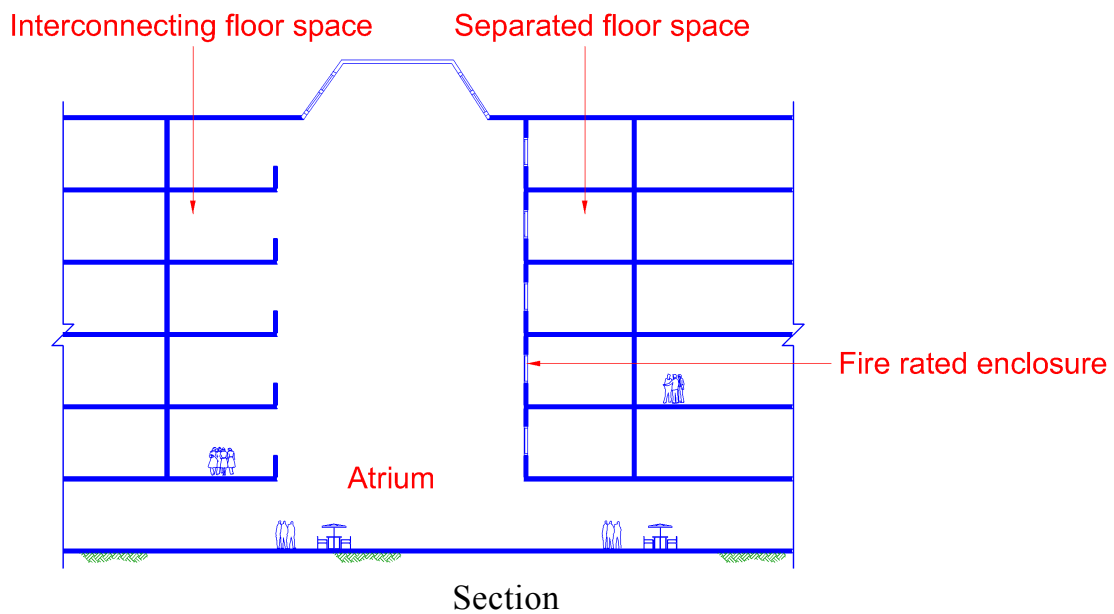
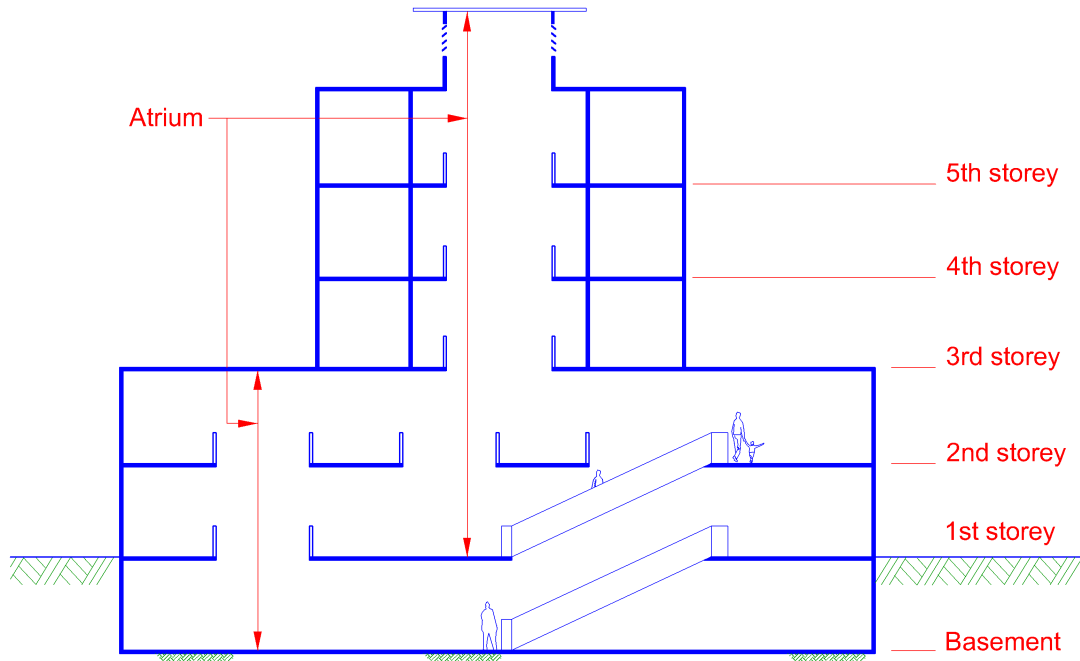

Diagram 1.2.5 - 1

Although atrium is defined as openings connecting 2 or more storeys, the requirements stipulated in cl. 3.2.6. is only applicable when the atrium is more than 3 storeys.





SectionDiagram 1.2.5 - 2

*The entire floor area of the interconnected space is open and unobstructed such that a fire in any part of the space will be readily obvious to the occupants of the space prior to the time it becomes a hazard to them*

# CHAPTER 1

## 1.2 DEFINITIONS

### 1.2.6 Basement storey

- (a) A storey of a building which is below the first storey and the floor of which is situated at such a level that more than half the height of such storey is below the level of the ground adjoining its perimeter walls for more than half the length of such perimeter walls, and

### EXPLANATIONS & ILLUSTRATIONS

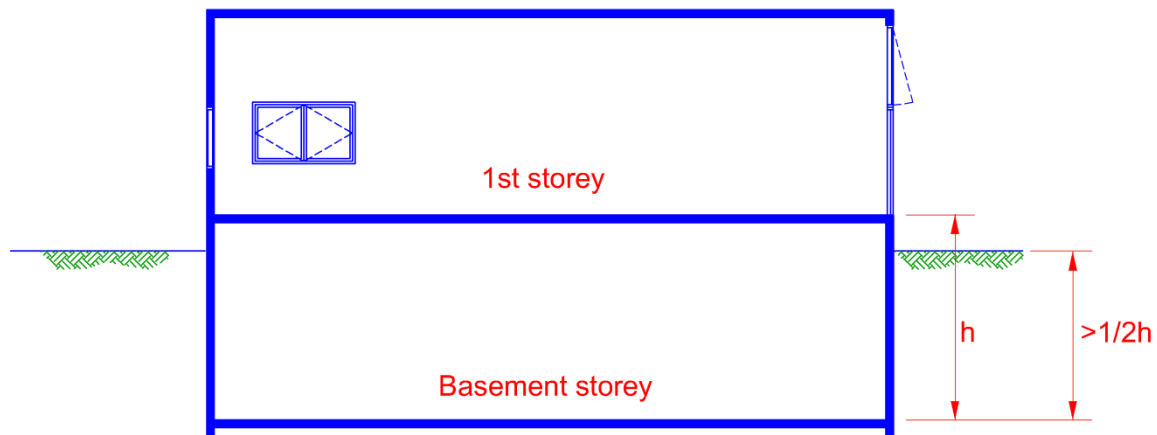

Sectional Elevation

*Diagram 1.2.6(a)*

(b) Where the building has no storey above ground, a storey the floor of which is situated at such a level that either the whole storey is below ground or more than half the height of such storey is below the level of the ground adjoining its perimeter walls for more than half the length of such perimeter walls.

**EXPLANATIONS & ILLUSTRATIONS**

**1.2.6**

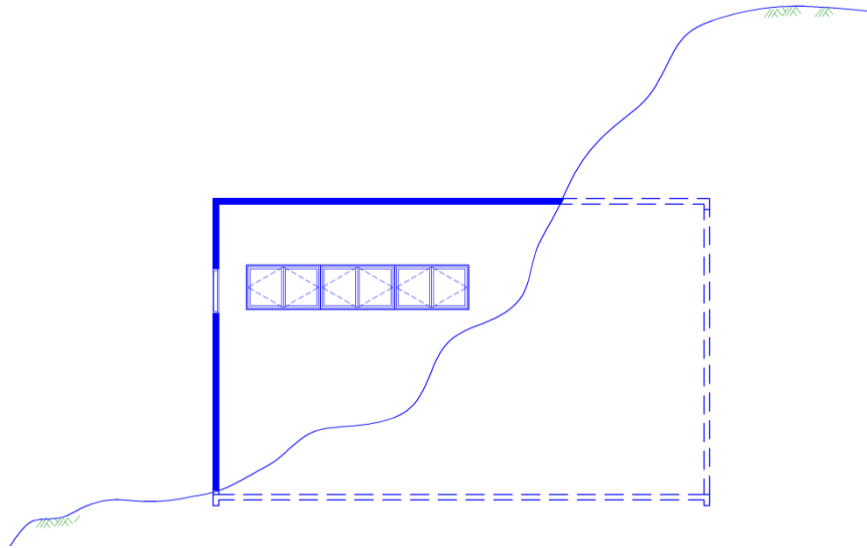

Sectional Elevation

Diagram 1.2.6(b)-1

*Building built on slope and partially covered by surrounded ground*

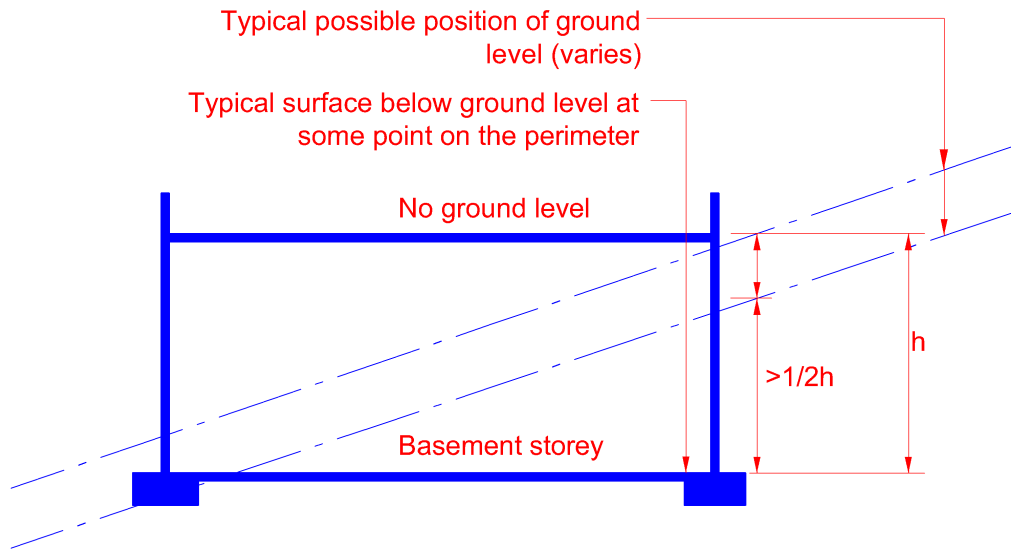

Sectional

Elevation

Diagram 1.2.6(b)-2

*Building with no ground level*

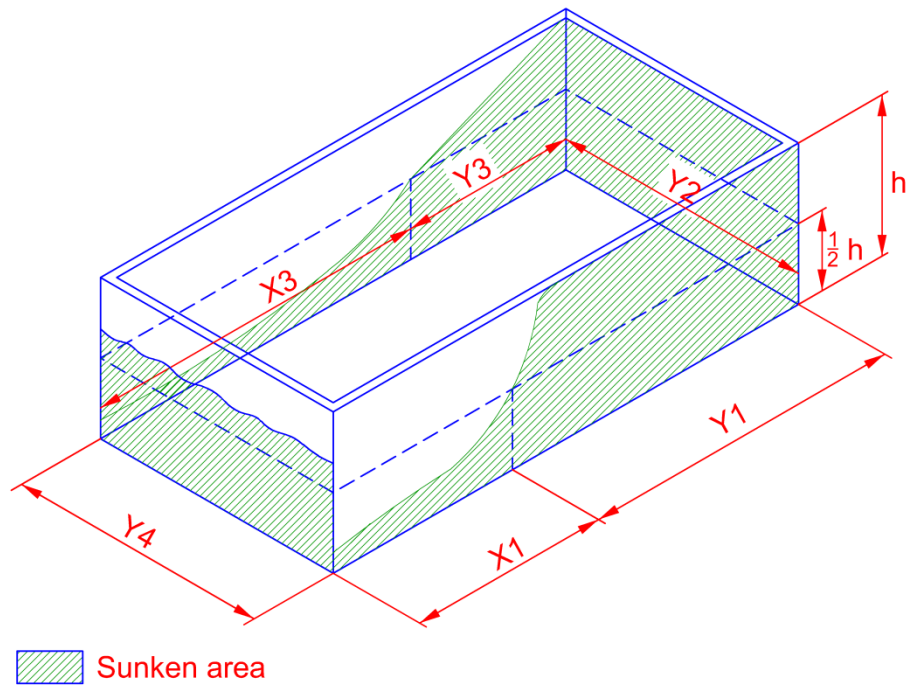

Diagram 1.2.6(b)-3

As  $Y_1 + Y_2 + Y_3 + Y_4 > X_1 + X_3$ , this level is considered as a basement.

# CHAPTER 1

## 1.2 DEFINITIONS

### 1.2.7 Boundary

The boundary of the land belonging to the building under consideration, and including the imaginary extension of the boundary up to the centre of an abutting public street, canal or river.

### EXPLANATIONS & ILLUSTRATIONS

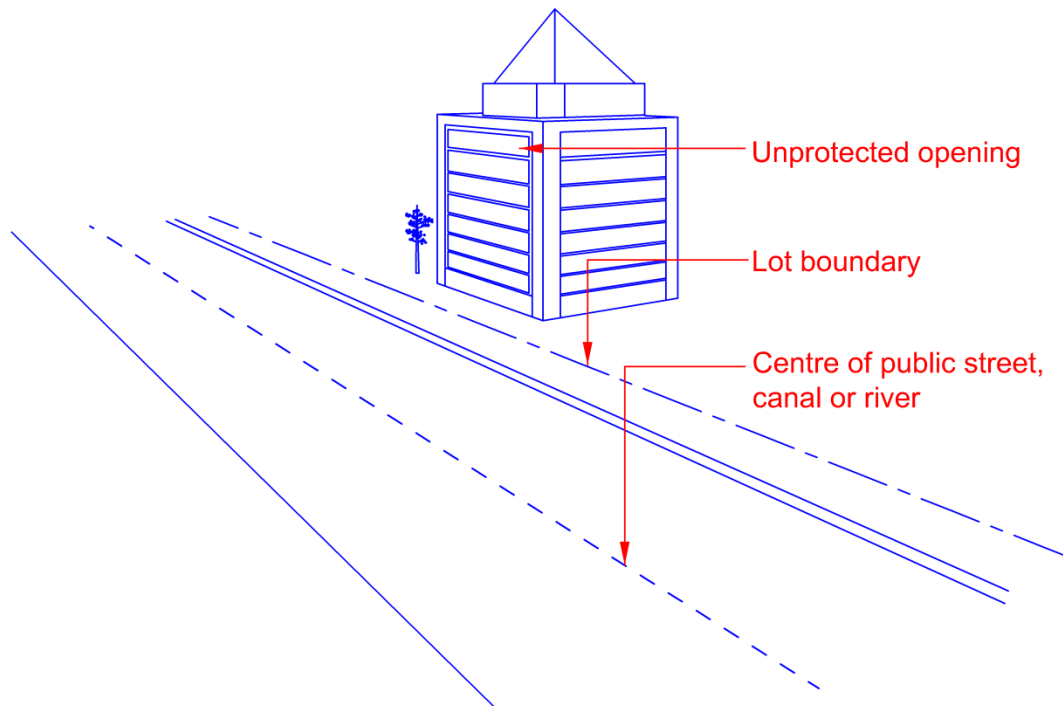

Diagram 1.2.7 - 1

*Buildings that are directly fronting or abutting a public street , canal or river can have the facade unprotected opening measuring up to the centre of the public street, canal or river*

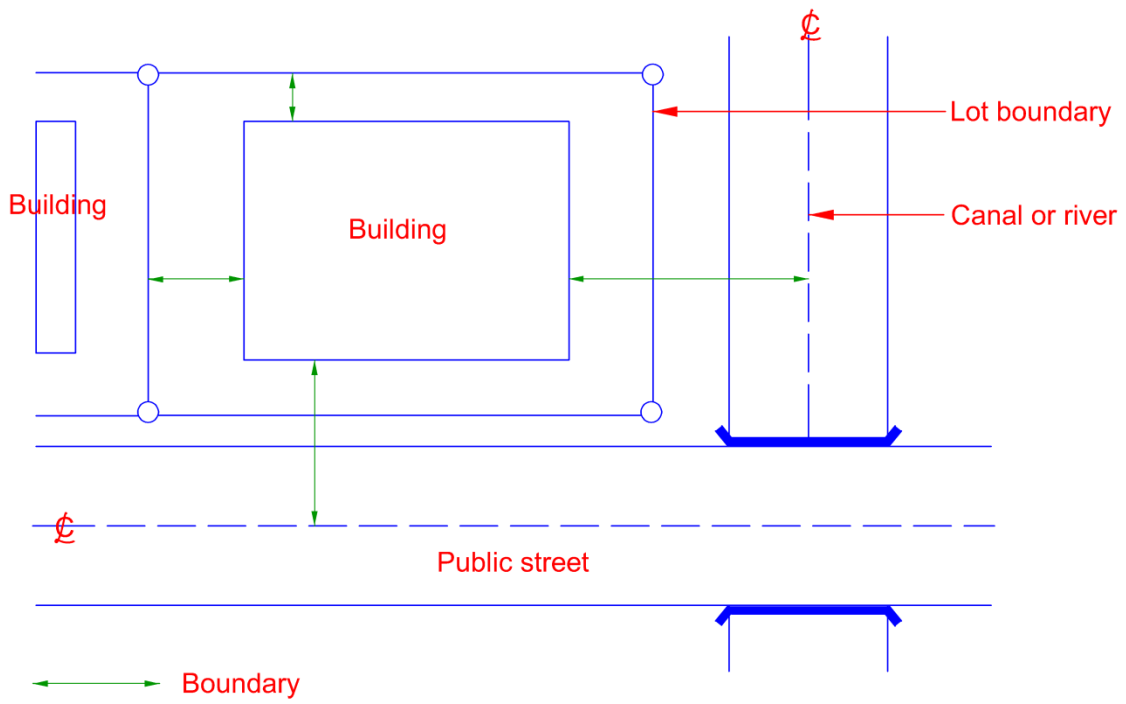

Diagram 1.2.7 – 2

*With regard to compliance of unprotected openings of the building that abuts a public street, it can be measured to the centre of public street instead of lot boundary*

# CHAPTER 1

## 1.2 DEFINITIONS

### 1.2.8 Cavity barrier

Construction provided :

(a) To seal a cavity (concealed space) against the penetration of smoke and flame, or

### EXPLANATIONS & ILLUSTRATIONS

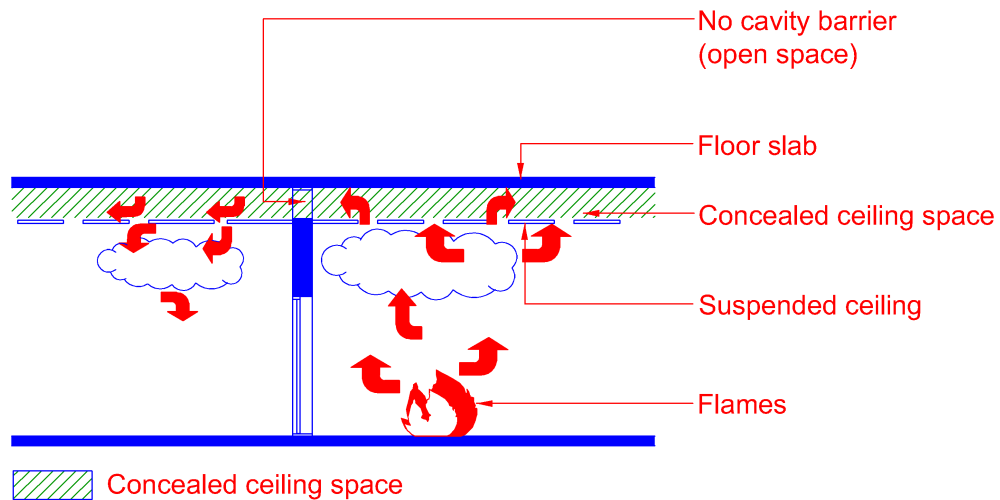

Sectional Elevation

*Diagram 1.2.8(a)-1*

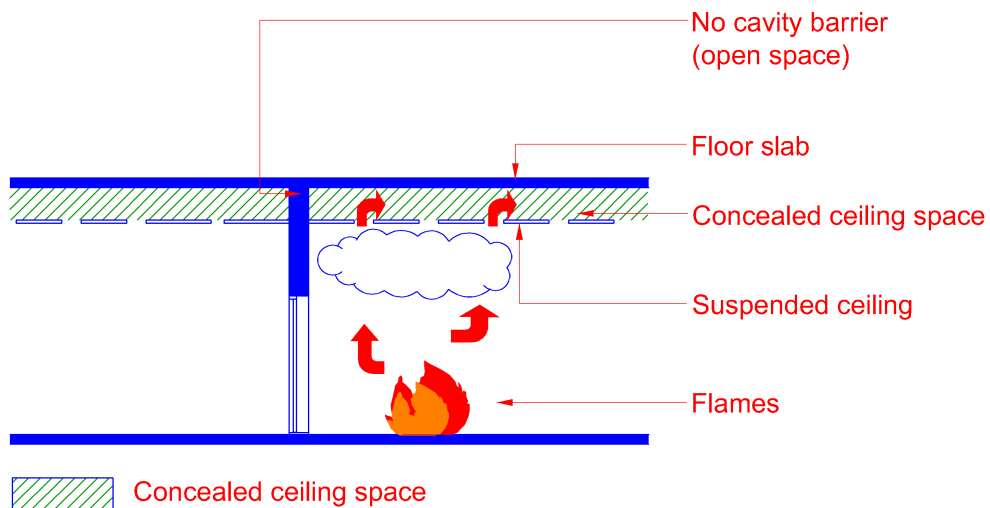

Sectional Elevation-concealed space in ceiling

*Diagram 1.2.8(a)-2*

(b) Within a cavity (concealed space) to stop the movement of smoke and flame within the cavity.

**EXPLANATIONS & ILLUSTRATIONS**

**1.2.8**

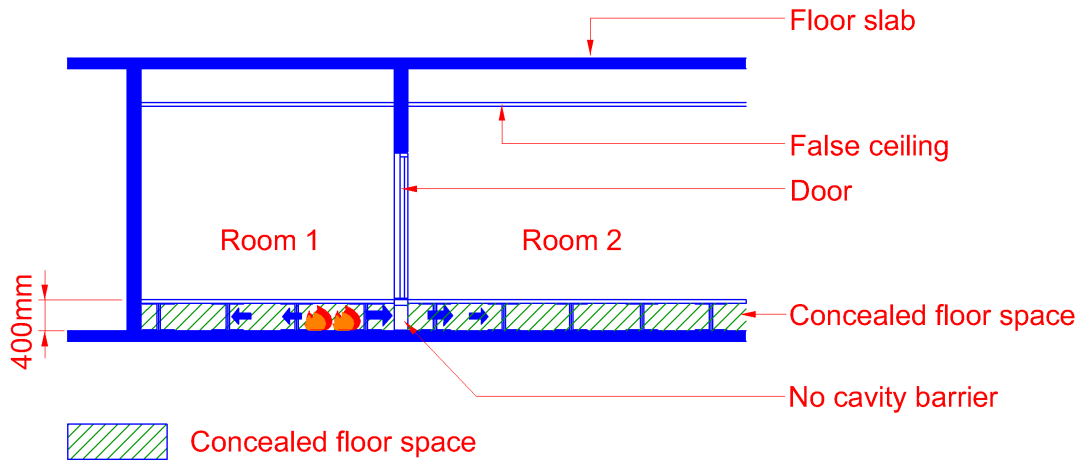

Sectional Elevation-concealed space below raised floor

Diagram 1.2.8(b)-1

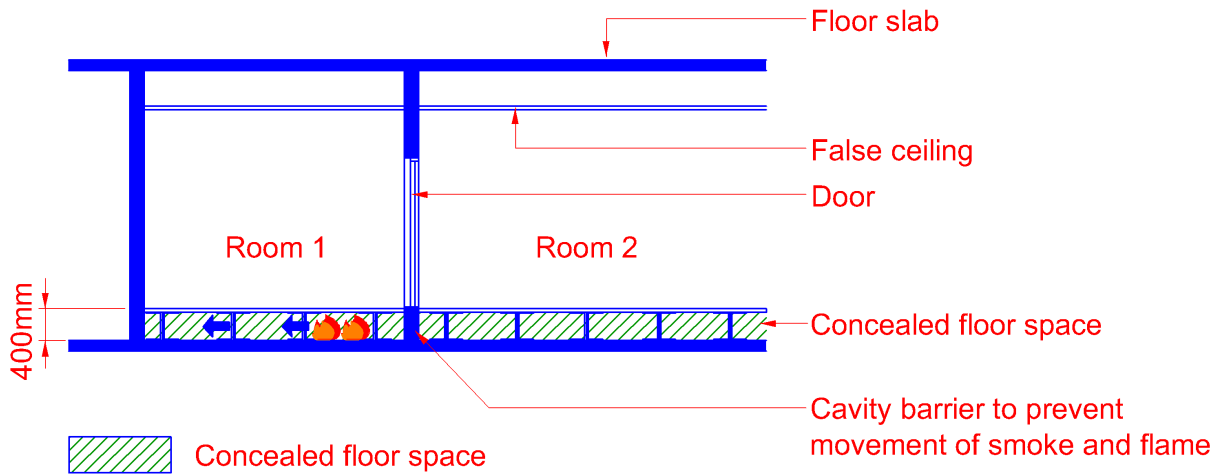

Sectional Elevation-concealed space below raised floor

Diagram 1.2.8(b)-2



# CHAPTER 1

## 1.2 DEFINITIONS

### 1.2.9 Ceiling

A part of a building which encloses and is exposed overhead in a room, circulation space or protected shaft. (A soffit or rooflight is included as part of its surface, but not the frame of a rooflight).

### EXPLANATIONS & ILLUSTRATIONS

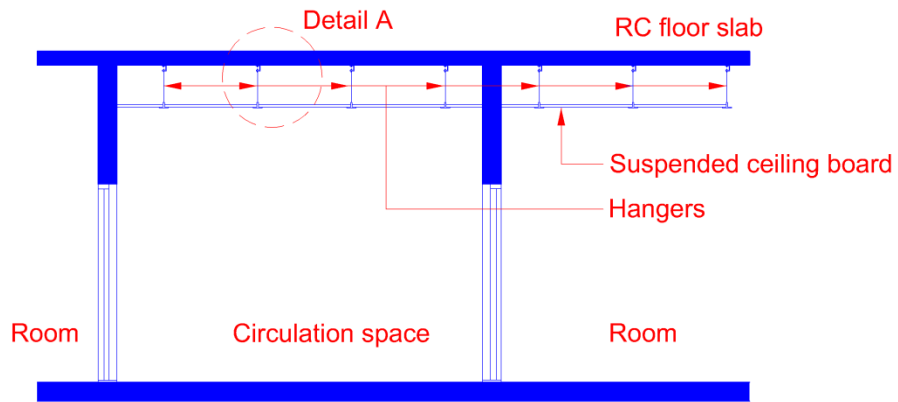

Sectional Elevation

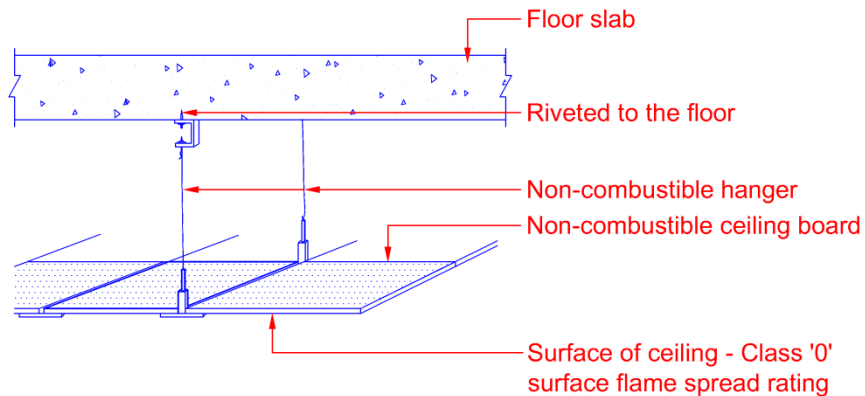

Detail A

*Diagram 1.2.9-1*

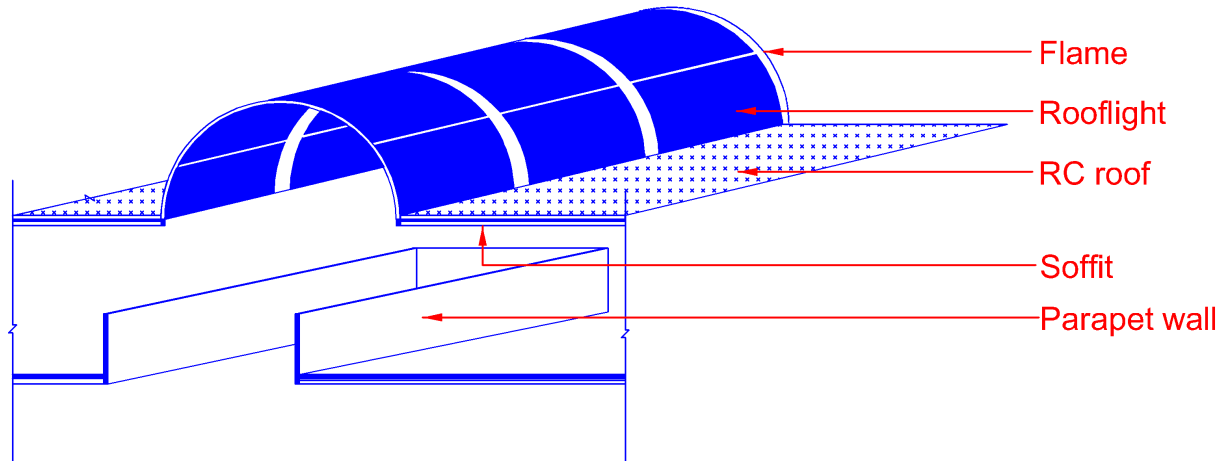

Section

Diagram 1.2.9-2

*Soffit and roof light(skylight) is included as part of the ceiling surface, but not the frame of the roof light*

# CHAPTER 1

## 1.2 DEFINITIONS

### 1.2.10 Circulation space

A space mainly used as means of access between a room or protected shaft and an exit from the building or compartment. It shall not contain any commercial activity such as information and reception counter, exhibition and the like.

### EXPLANATIONS & ILLUSTRATIONS

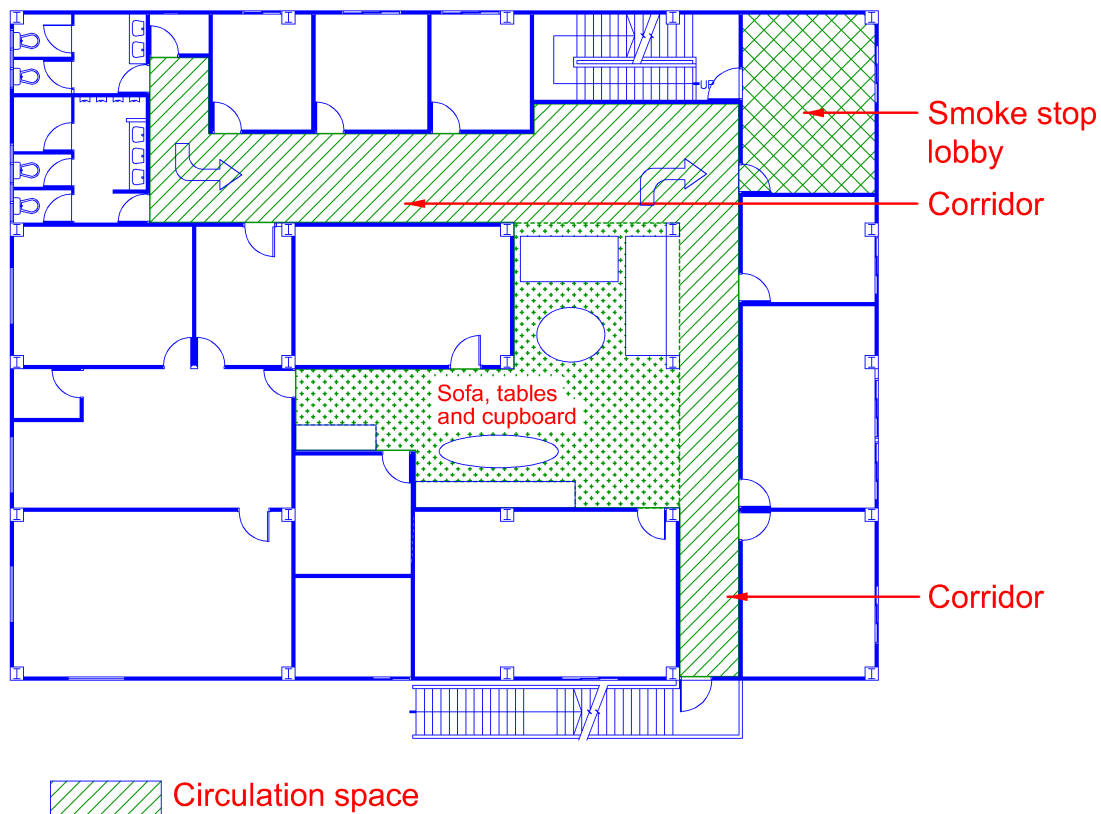

*Plan – Typical Floor Plan*

*Diagram 1.2.10*

*In general, circulation space refers to common corridors, lobbies, etc. it is a common area for access of occupants from a room to an exit. Such common areas are normally separated from other area with partition/walls..Circulation space is non-simultaneous occupancy and without activity. No occupant load is designated for circulation space.*

*Note that car park cannot be deemed as circulation space as it is accorded with occupant load factor of 30m<sup>2</sup> per person.*

# CHAPTER 1

## 1.2 DEFINITIONS

### 1.2.11 Code of practice

Code of practice is the standard of practice acceptable to the Relevant Authority. The Relevant Authority may adopt requirements stipulated in the stated year of publication of any referred Code of Practice or at its discretion adopt those specified in a later version.

### EXPLANATIONS & ILLUSTRATIONS

*(No illustration)*

*It includes all subsequent amendments that may be issued by the SCDF. Examples of Codes of Practice or Standards that are acceptable to SCDF are :*

- a) Singapore Standards Codes of Practice*
- b) British Standards Codes of Practice*
- c) Australian Standards*
- d) National Fire Prevention Association (NFPA) 130*

*For buildings which have been approved based on earlier Code of Practice for Fire Precautions in Buildings, SCDF may consider applying the latest version to all new Additions and Alterations or Extension of works.*

# CHAPTER 1

## 1.2 DEFINITIONS

### 1.2.12 Compartment

A part of a building separated from all other parts of the same building by compartment walls and/or compartment floors. A roof space above the top storey of a compartment is included in that compartment

### EXPLANATIONS & ILLUSTRATIONS

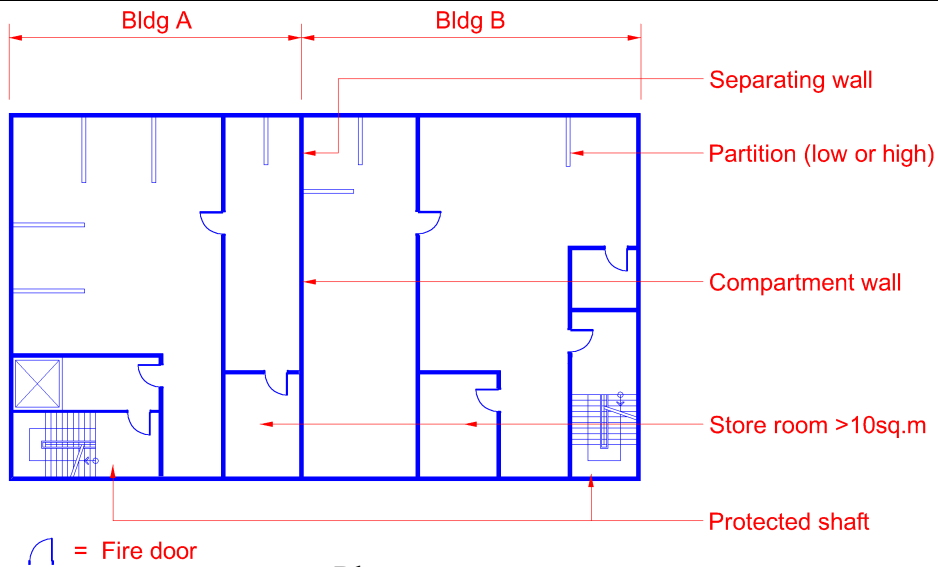

Plan

Diagram 1.2.12- 1

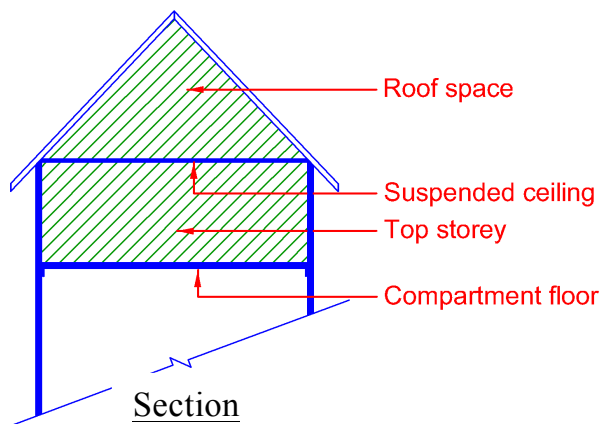

Section

Diagram 1.2.12- 2

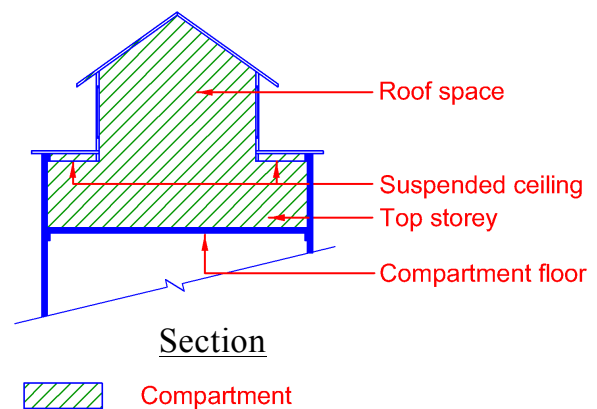

Section

Diagram 1.2.12- 3

# CHAPTER 1

## 1.2 DEFINITIONS

### 1.2.13 Compartment wall & Compartment floor

A wall or a floor which is provided for the purpose of dividing a building into compartments for the purposes of Cl.3.2 and complies with Cl.3.7.

### EXPLANATIONS & ILLUSTRATIONS

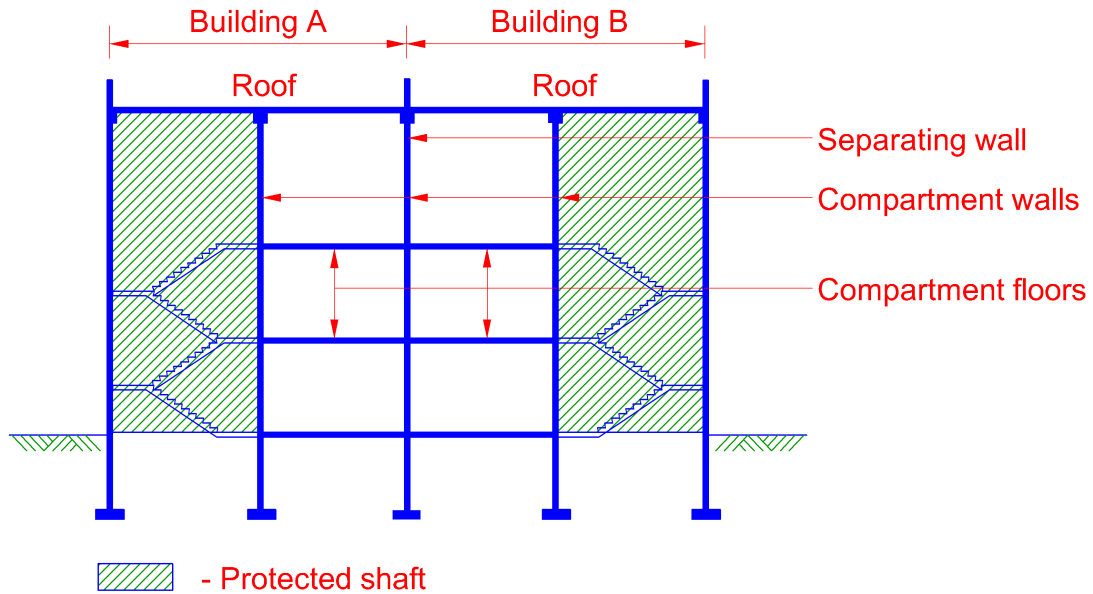

Section

*Diagram 1.2.13*

# CHAPTER 1

## 1.2 DEFINITIONS

<b>1.2.14 Concealed space (cavity)</b>	
<p>A space enclosed by elements of a building (including a suspended ceiling or raised floor or space between curtain walling and the floor slab or spandrel wall) or contained within an element but not a room, cupboard, circulation space, protected shaft or space within a flue, chute, duct, pipe or conduit.</p>	
<b>EXPLANATIONS &amp; ILLUSTRATIONS</b>	
<p><i>(Please refer to Cl.1.2.8 for illustration)</i></p>	

# CHAPTER 1

## 1.2 DEFINITIONS

### 1.2.15 Corridor

A passage providing means of access from rooms or spaces to an exit.

#### EXPLANATIONS & ILLUSTRATIONS

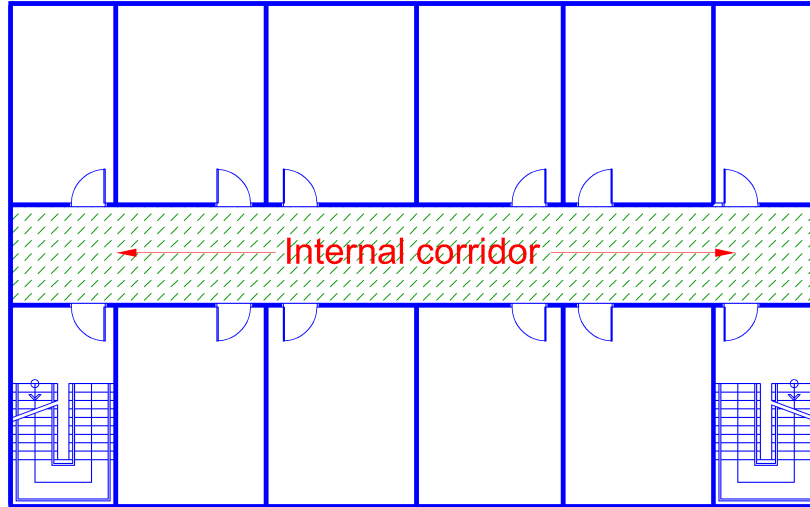

Plan– Internal corridor

Diagram 1.2.15- 1

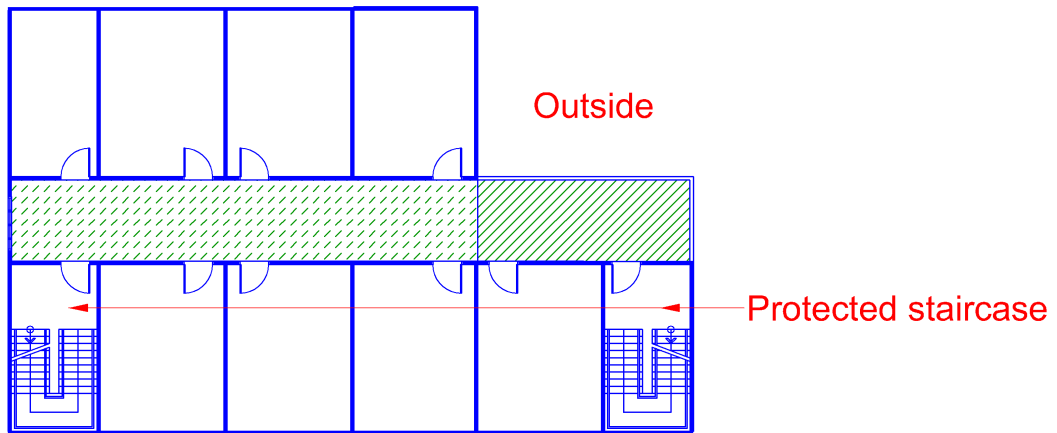

-  External corridor
-  Internal corridor

Plan

Diagram 1.2.15- 2



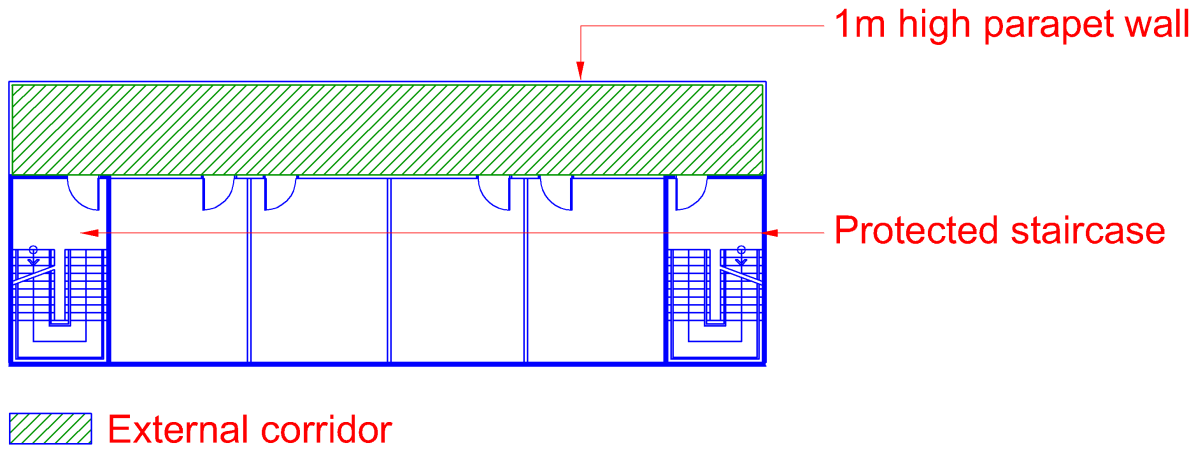

Plan

*Diagram 1.2.15- 3*

# CHAPTER 1

## 1.2 DEFINITIONS

### 1.2.16 Cubical extent of building or compartment

The cubical extent of a building or compartment shall be ascertained by measuring the volume of space contained within the building or compartment:

- (a) The inner finished surfaces of the enclosing walls or, on any side where there is no enclosing wall, a plane extending vertically above the outermost edge of the floor on that side,

### EXPLANATIONS & ILLUSTRATIONS

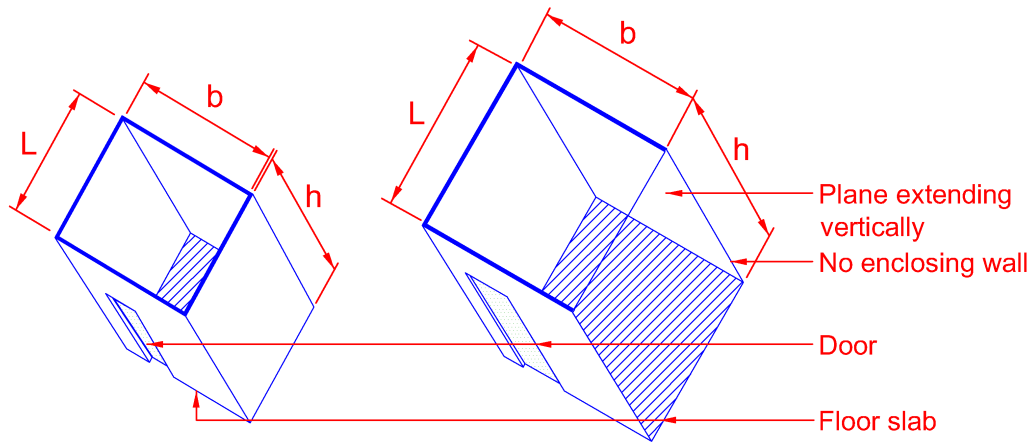

Cubical extent =  $L \times b \times h$

Diagram 1.2.16(a)

(b) The upper surface of its lowest floor, and

**EXPLANATIONS & ILLUSTRATIONS**

**1.2.16**

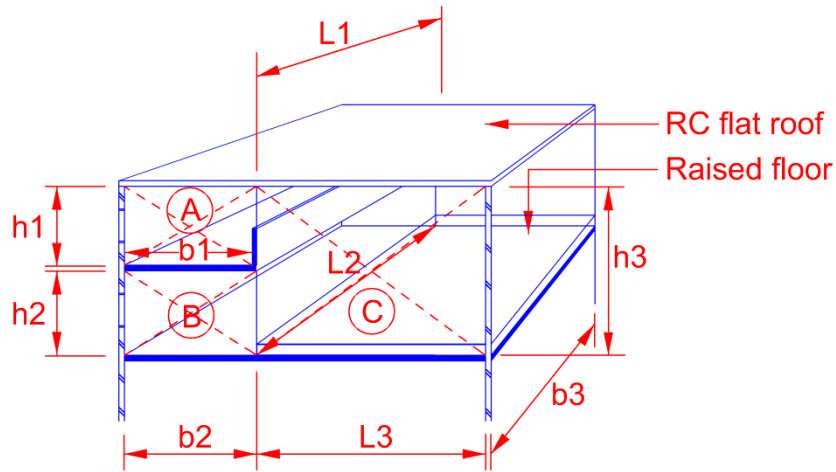

Cubical extent of 3<sup>rd</sup> storey :  $A = (L1 \times b1 \times h1) +$   
 $B = (L2 \times b2 \times h2) +$   
 $C = (L3 \times b3 \times h3)$

*Diagram 1.2.16(b)*

(c) In the case of a building or compartment which extends to a roof, the under surface of the roof or, in the case of any other compartment, the under surface of the ceiling of the highest storey within the compartment, including the space occupied by any other wall, or any unprotected shafts, ducts or structure within the space to be so measured, but excluding protected lift walls, exit staircases and other accommodation (such as lavatory and locker rooms) which are enclosed with walls having fire resistance of not less than one hour and openings protected by doors of one half hour fire resistance fitted with automatic self-closing device.

**EXPLANATIONS & ILLUSTRATIONS**

**1.2.16**

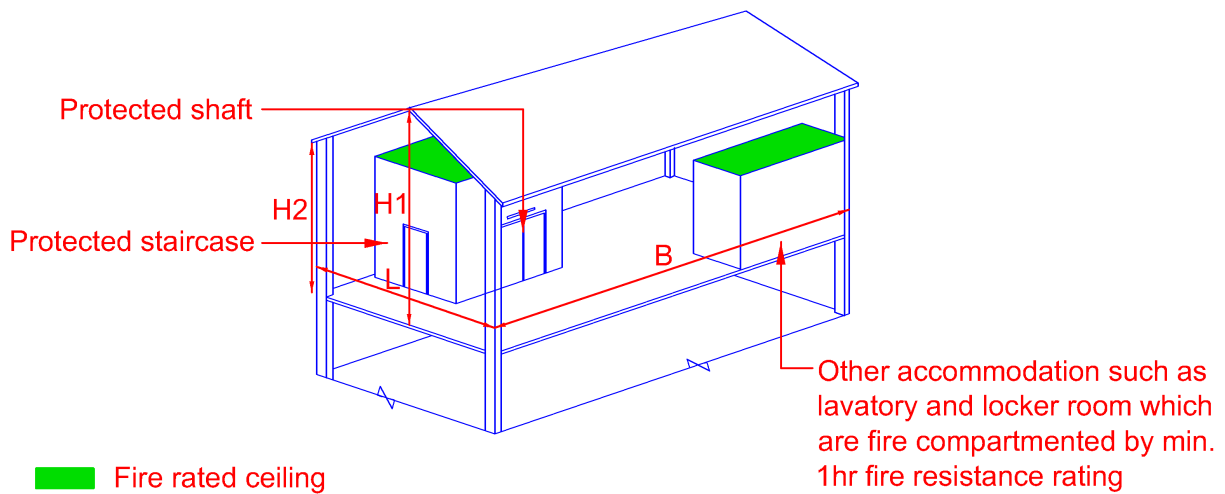

$$\text{Cubical extent} = \frac{(H1 + H2)}{2} \times L \times B \quad (\text{less volume of protected shaft, protected staircase and separately compartmented lavatory/locker room})$$

Diagram 1.2.16(c)

# CHAPTER 1

## 1.2 DEFINITIONS

### 1.2.17 Dead-end

A dead-end refers to a situation within a common area, normally a corridor or lift lobby spaces, where exit is only possible from one end, with no possible escape from the other end. The maximum length of such dead-end spaces shall not exceed 15m or 20m (sprinklered) as stipulated in Table 2.2A, column (vi) see diagram 1.2.17.

### EXPLANATIONS & ILLUSTRATIONS

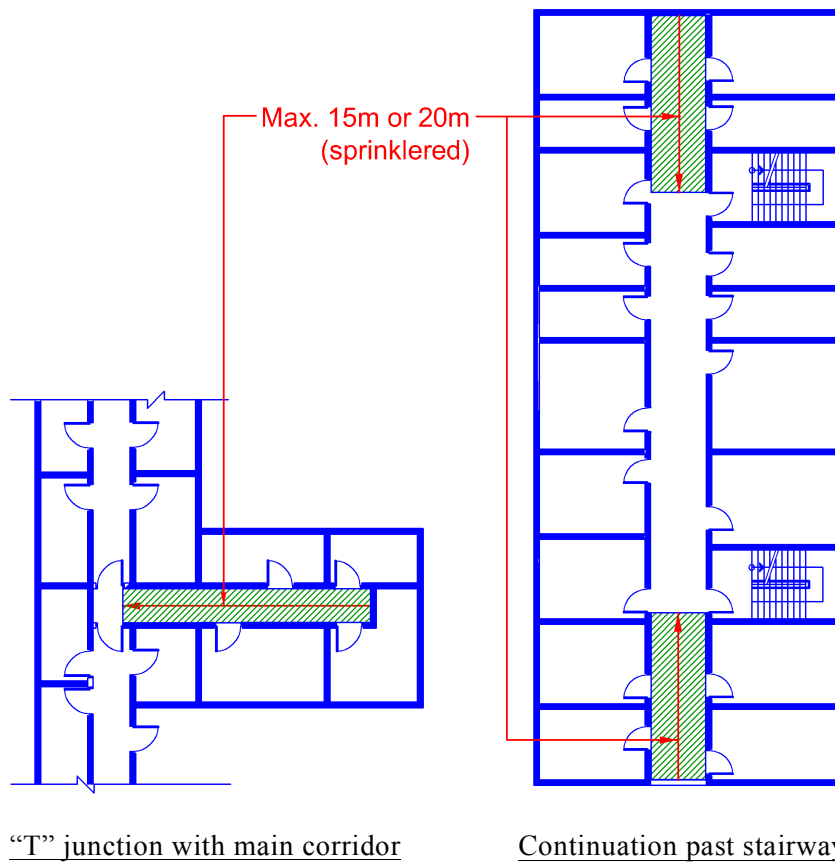

*Diagram 1.2.17*

# CHAPTER 1

## 1.2 DEFINITIONS

### 1.2.18 Direct distance

The shortest distance from a point in a room or space, measured within the external enclosure walls of the room or space to the relevant exits, ignoring internal walls, partitions and fittings other than the enclosure walls of exit passageways or exit staircases.

### EXPLANATIONS & ILLUSTRATIONS

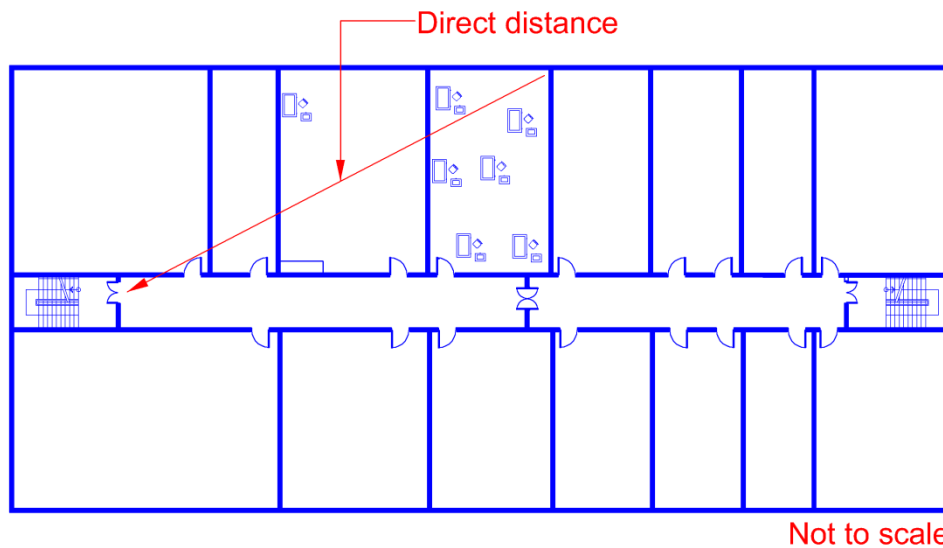

Plan

Diagram 1.2.18-1

**“Direct Distance”** means the shortest distance from any point within the floor area, measured with the external enclosures of the building, to the relevant exit ignoring walls, partitions and fittings other than the enclosing walls/partitions to protected staircases.

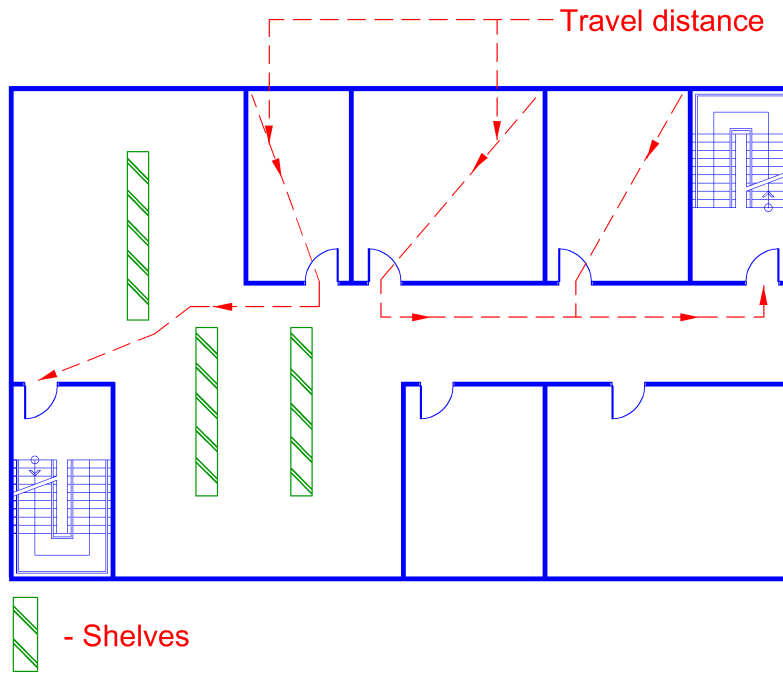

Plan

Diagram 1.2.18-2

**“Travel Distance”** means the actual distance to be travelled by a person from any point within a floor area to the relevant exit having regard to the layout of walls, partitions, fixtures and fitting.

# CHAPTER 1

## 1.2 DEFINITIONS

<b>1.2.19 Door</b>	
<p>Includes any shutter, cover or other form of protection to an opening in any wall or floor of a building or in the structure surrounding a protected shaft, regardless of whether the door is constructed of one or more leaves.</p>	
<b>EXPLANATIONS &amp; ILLUSTRATIONS</b>	
<p><i>(No illustration)</i></p>	



# CHAPTER 1

## 1.2 DEFINITIONS

### 1.2.20 Electro-magnetic or electro-mechanical device susceptible to smoke

A device which will allow a door held open by it to close automatically in the event of each or anyone of the following:

- (a) Detection of smoke by automatic apparatus suitable in nature, quality and location, and
- (b) Operation of a hand operated switch fitted in a suitable position, and
- (c) Failure of electricity supply to the device, apparatus or switch, and
- (d) Operation of the fire alarm system if any.

### EXPLANATIONS & ILLUSTRATIONS

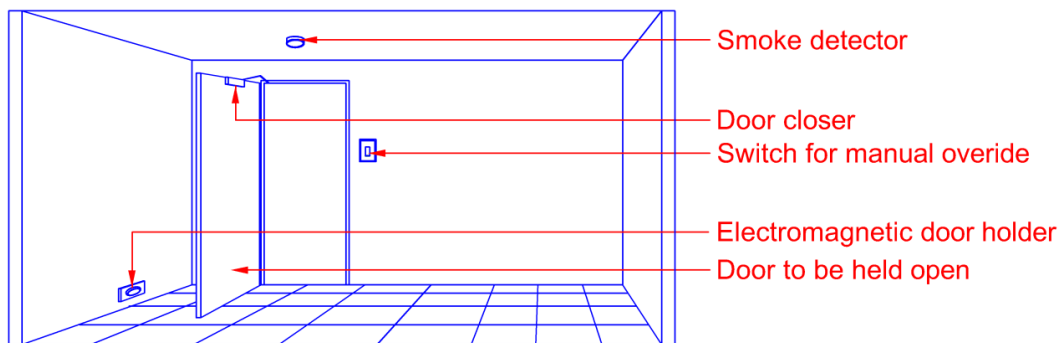

Diagram 1.2.20

Door is held open position by Electro-magnetic or electro-mechanical device

Where the fire door poses a hindrance to movement between a fire compartment and another, for example, fire door across access corridor, fire door to kitchen, it is permissible to hold the fire door in the open position by electro-magnetic or electro-mechanical device

# CHAPTER 1

## 1.2 DEFINITIONS

### 1.2.21 Element of Structure

- (a) A member forming part of the structural frame of a building or any other beam or column but not a member forming part of a roof structure only,
- (b) A loadbearing wall or loadbearing part of a wall,
- (c) A floor, including a compartment floor, other than the lowest floor (in contact with the ground) of a building,
- (d) An external wall,
- (e) A separating wall,
- (f) A compartment wall, and
- (g) A structure enclosing a protected shaft (protecting structure).

### EXPLANATIONS & ILLUSTRATIONS

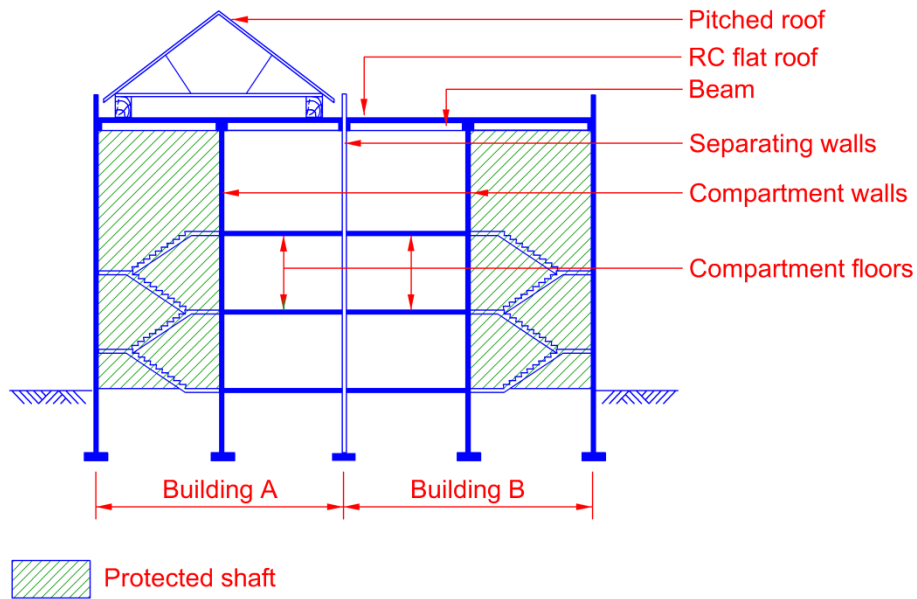

Diagram 1.2.21

#### Sectional Elevation

For building A the pitched roof is not considered as part of the structural frame of the building. However, the RC slab and beam supporting the pitched roof are considered elements of structures as they help to carry the dead load imposed by the pitched roof. For building B the RC roof is not considered as an element of structure. However, the beams supporting the RC roof are considered to be elements of structure of the building.

The columns supporting the pitch roofs are not element of structure as they are not part of the column supporting the whole building. Hence the columns only need to be constructed of non-combustible material.

# CHAPTER 1

## 1.2 DEFINITIONS

<b>1.2.22 Emergency generator</b>	
Emergency power generating equipment that complies with the requirements stipulated in SS 535 Code of Practice for Installation, Operation, Maintenance, Performance and Constructional Requirements of Mains Failure Standby Generating Systems.	
<b>EXPLANATIONS &amp; ILLUSTRATIONS</b>	
<i>No illustration.</i>	

Emergency power generating equipment that complies with the requirements stipulated in SS 535 Code of Practice for Installation, Operation, Maintenance, Performance and Constructional Requirements of Mains Failure Standby Generating Systems.

### EXPLANATIONS & ILLUSTRATIONS

*No illustration.*

# CHAPTER 1

## 1.2 DEFINITIONS

### 1.2.23 Emergency Lighting and Exit Lighting

- (a) Emergency lighting means lighting provided with a secondary source of power supply.
- (b) Exit lighting means that part of emergency lighting which is provided to illuminate the exits.

### EXPLANATIONS & ILLUSTRATIONS

*No illustration.*

# CHAPTER 1

## 1.2 DEFINITIONS

### 1.2.24 Exit

A means of escape from the interior of the building to an exterior space which is provided by the use of the following either singly or in combination: exterior door openings, exit staircases, exit ramps or exit passageways. In the case of an exit leading to a separate building, exits also include linkways, walkways, bridges and balconies. Exit shall not include access stairs, aisles, corridor doors or corridors and access doors to rooms or spaces in occupancy areas.

### EXPLANATIONS & ILLUSTRATIONS

*No illustration.*

# CHAPTER 1

## 1.2 DEFINITIONS

<b>1.2.25 Exit door</b>	
A door provided at the doorway of an exit for the passage of people, forming part of the integrity of the exit, including the exterior door opening.	
<b>EXPLANATIONS &amp; ILLUSTRATIONS</b>	
<i>See illustration 1.2.25(A)</i>	

A door provided at the doorway of an exit for the passage of people, forming part of the integrity of the exit, including the exterior door opening.

### EXPLANATIONS & ILLUSTRATIONS

*See illustration 1.2.25(A)*

# CHAPTER 1

## 1.2 DEFINITIONS

### 1.2.25 (A) Exit access

That portion of a means of escape that leads to an exit. It includes the room and building spaces that people occupy, the doors along the escape routes, lobbies, aisles, passageways, corridors, access stairs and ramps that will be traversed in order to reach an exit.

### EXPLANATIONS & ILLUSTRATIONS

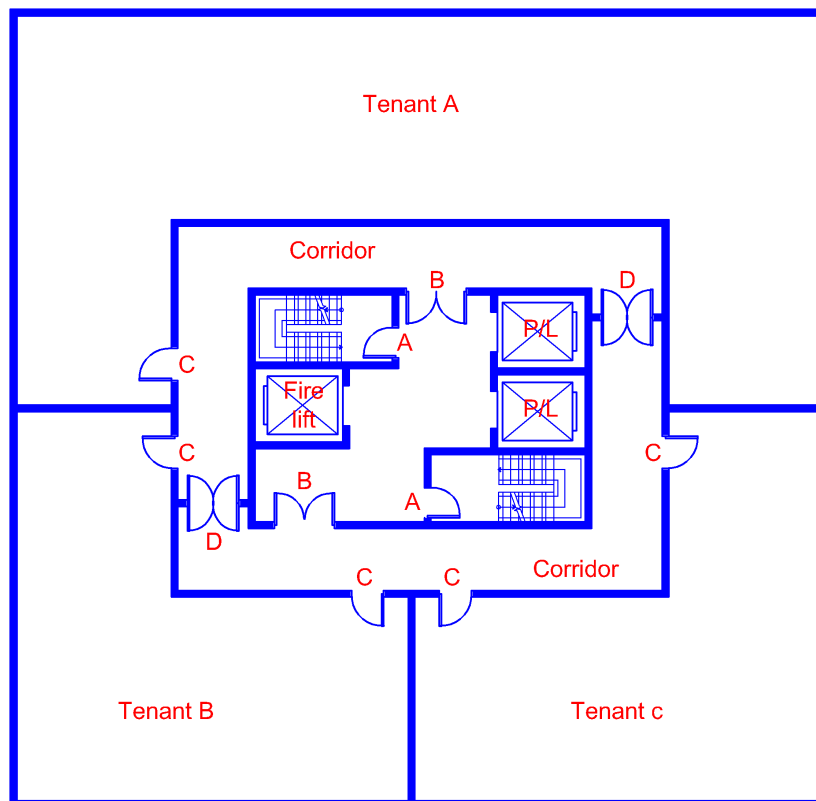

*Door A = exit doors*

*Door B, C & D = exit access doors*

*Diagram 1.2.25(A)- 1*

*Existing : - Exit access door shall comply with all the requirements of an exit door and need not have fire resistance rating, unless it is specified*

All exit access doors are required to comply with the requirements for exit door in respect of door swing and headroom, and need not have fire resistance rating, unless it is specified.

Doors that lead through wall panelling and that harmonize in appearance with the adjoining wall are not acceptable, as casual occupants may not be aware of such doors for means of escape even though actually visible. Exit access doors shall be designed and arranged to be clearly recognizable. As exit access door is a door which provides access to a room or space, for example, the entrance door to an office or doors installed across the escape path leading to an exit. It would be overly stringent if exit access door is required to comply with all the requirements of a exit door, except fire resistance rating if specified, for example, we would normally provide lock set to the exit access door to offices, but lock set is not allowed to be installed in exit door.

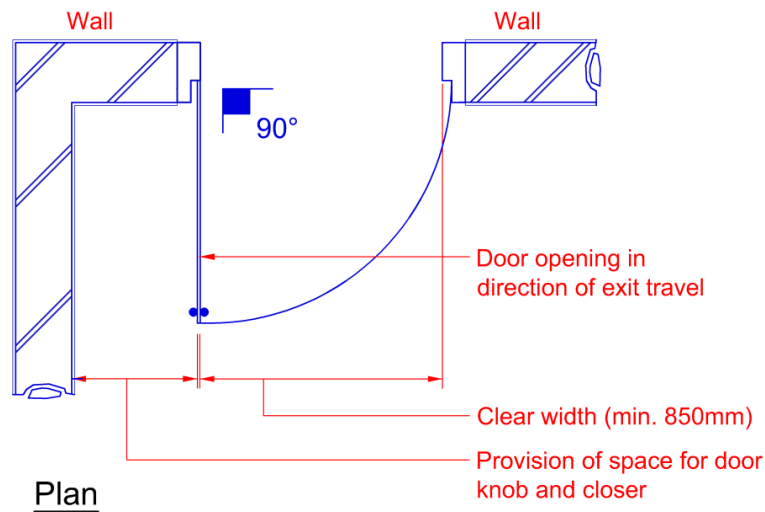

Diagram 1.2.25(A)- 2

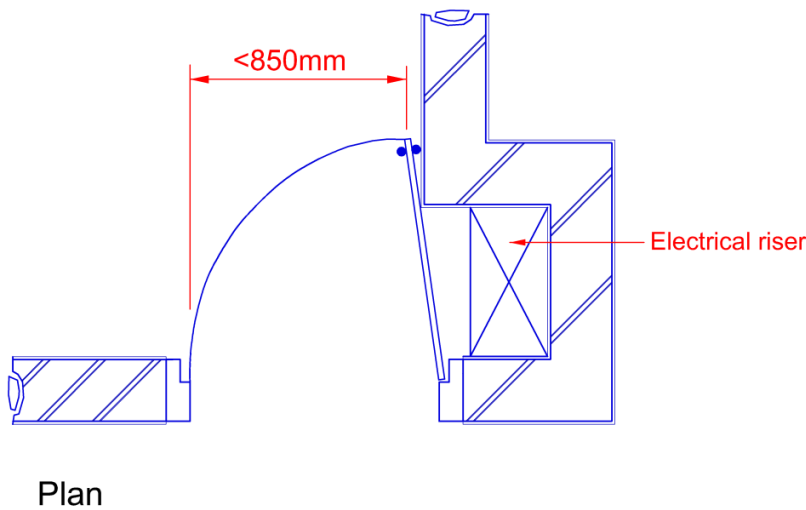
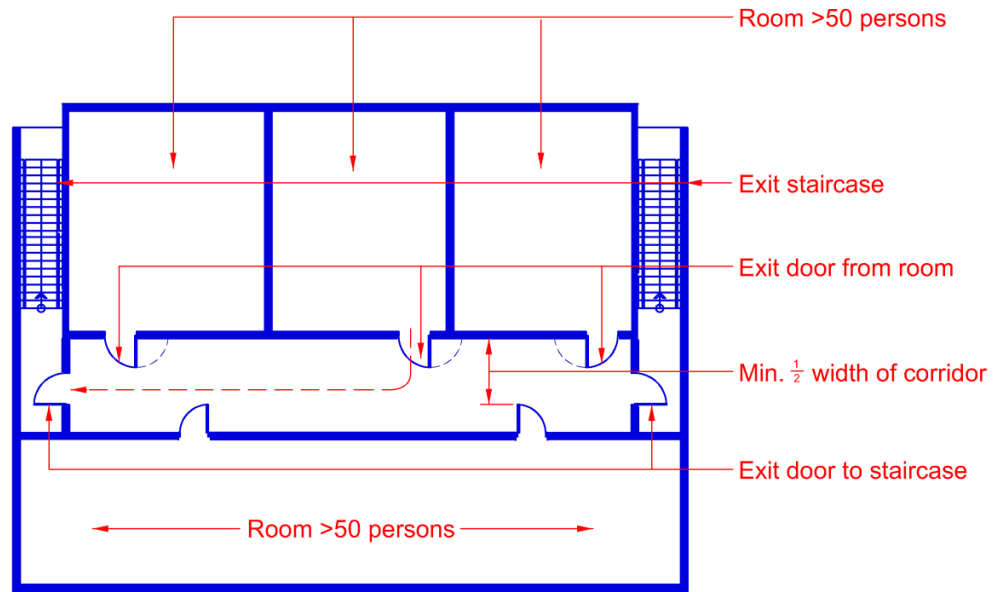

Diagram 1.2.25(A)- 3

The above layout is **not acceptable**

The clear width of the exit door opening is less than 850mm and the door is opened at an angle of less than 90 degree





**Plan**

*Diagram 1.2.25(A)- 4*

*Exit doors which open into the common corridor should not cause obstruction to movement of occupants, cross reference to Clause 2.3.9d*

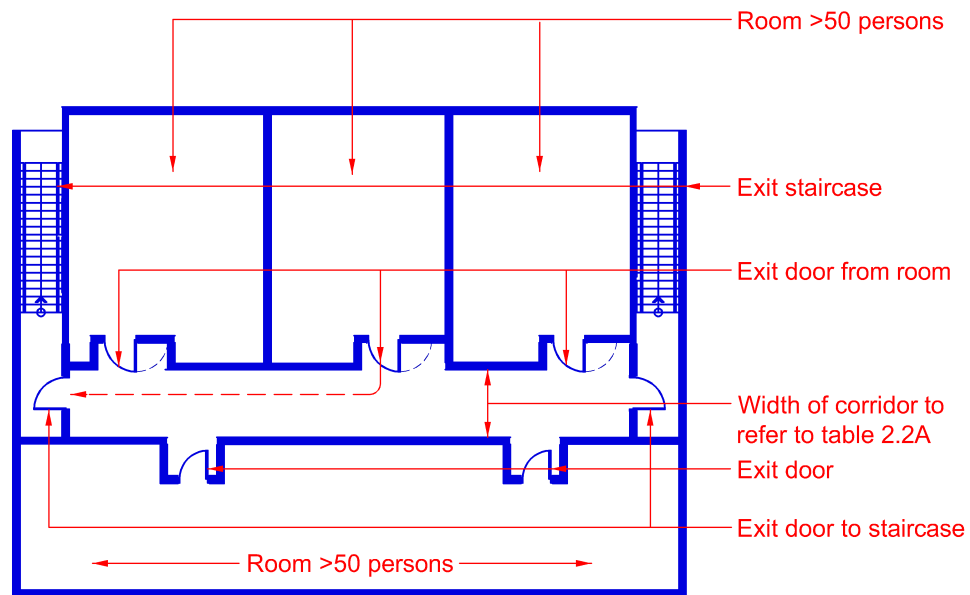

**Plan**

*Diagram 1.2.25(A) - 5*

*Exit doors which cause obstruction when open into the common corridor shall recessed, cross reference to Clause 2.3.9d*

# CHAPTER 1

## 1.2 DEFINITIONS

<b>1.2.25(B) Exit Access Door</b>	
-----------------------------------	--

<p>A door which provides access to a room or space (excluding toilet cubicle, bedroom, storeroom, utility room, pantry and the like) or installed across the escape path leading to an exit. Exit access door shall comply with all the requirements of an exit door and need not have fire resistance rating, unless it is specified.</p>	
--	--

<b>EXPLANATIONS &amp; ILLUSTRATIONS</b>	
---	--

*See illustration 1.2.25(A)*

# CHAPTER 1

## 1.2 DEFINITIONS

### 1.2.26 Exit passageway

A horizontal extension of a vertical exit viz exit staircase or a passage leading from a courtyard to an open exterior space, complying with the requirements of Cl.3.8 for protected shafts in respect of fire resistance ratings for enclosure walls, floors, ceilings and doors, that serves as a required exit.

Exit passageway shall be required to comply with the provisions of Cl.2.3.2.

### EXPLANATIONS & ILLUSTRATIONS

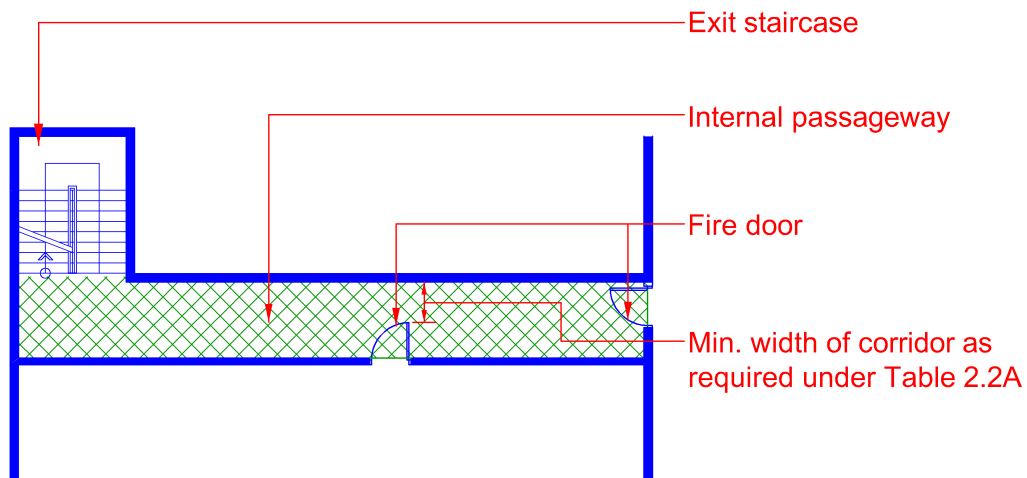

Plan – Internal exit

Diagram 1.2.26 - 1

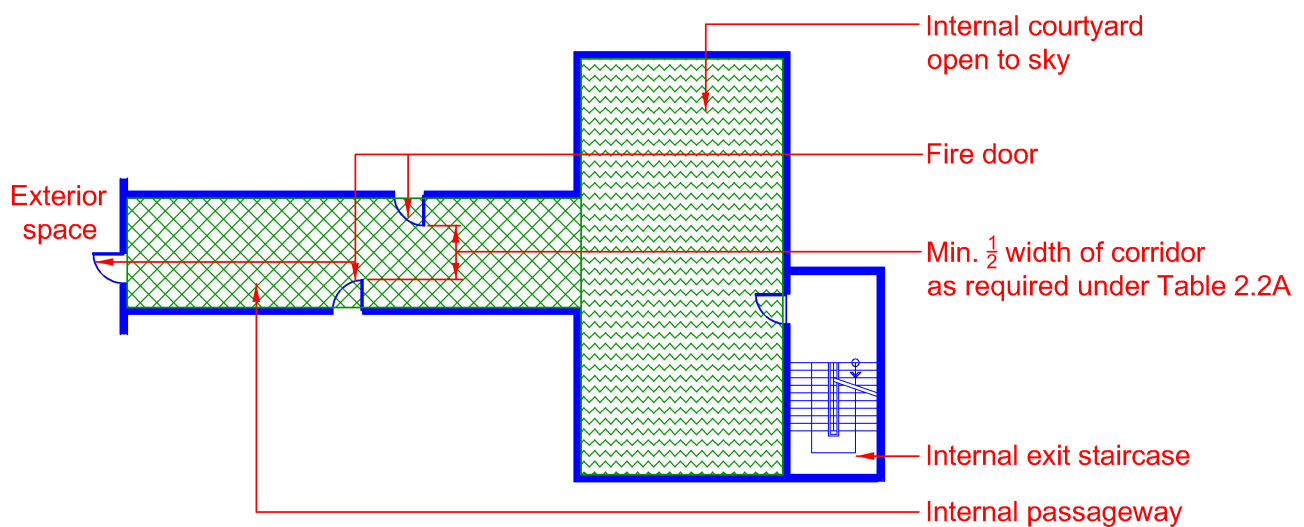

1<sup>st</sup> storey plan – Internal

Diagram 1.2.26 - 2

# CHAPTER 1

## 1.2 DEFINITIONS

### 1.2.27 Exit staircase

A staircase which has its enclosure constructed of non-combustible material having a fire resistance of not less than the minimum period required by Cl.3.3, for Elements of Structure for the part of the building in which it is situated.

### EXPLANATIONS & ILLUSTRATIONS

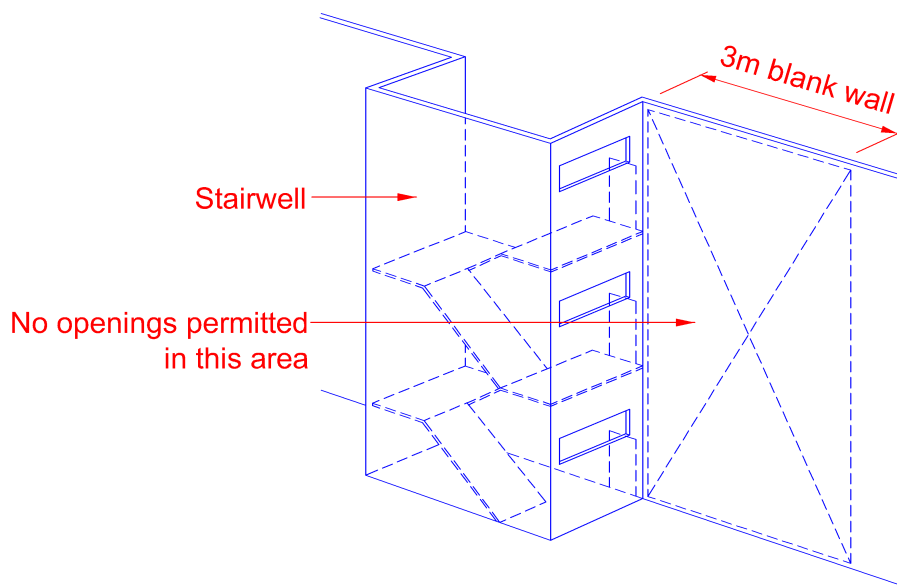

Diagram 1.2.27 – 1

Alternative method of protecting stairway enclosures

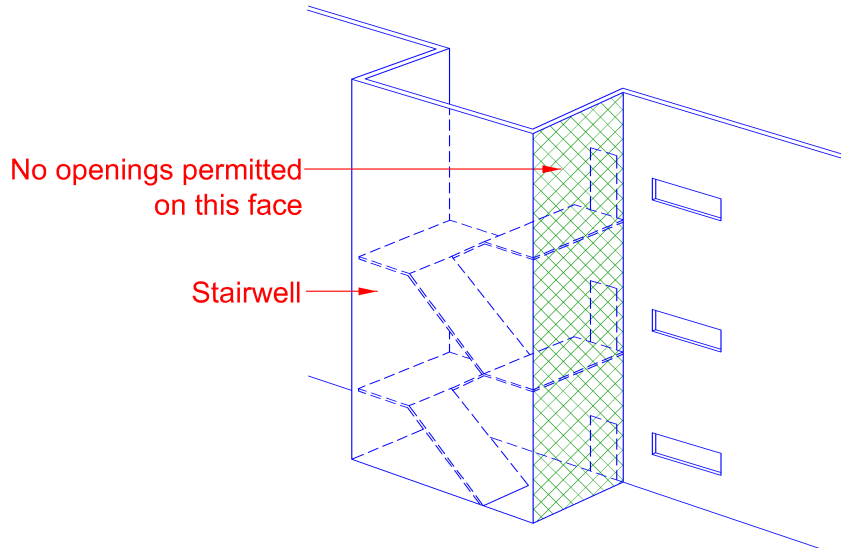

Diagram 1.2.27 – 2

Where the stairway enclosure projects beyond the external wall of the building and is connected thereto, then either :

- (a) the external wall or wall of any part of the building less than 3m from the stairway enclosure, or
- (b) the external wall or walls of any part of the stairway enclosure within any 3m from the building should be imperforate and of not less than one hour fire resistance.

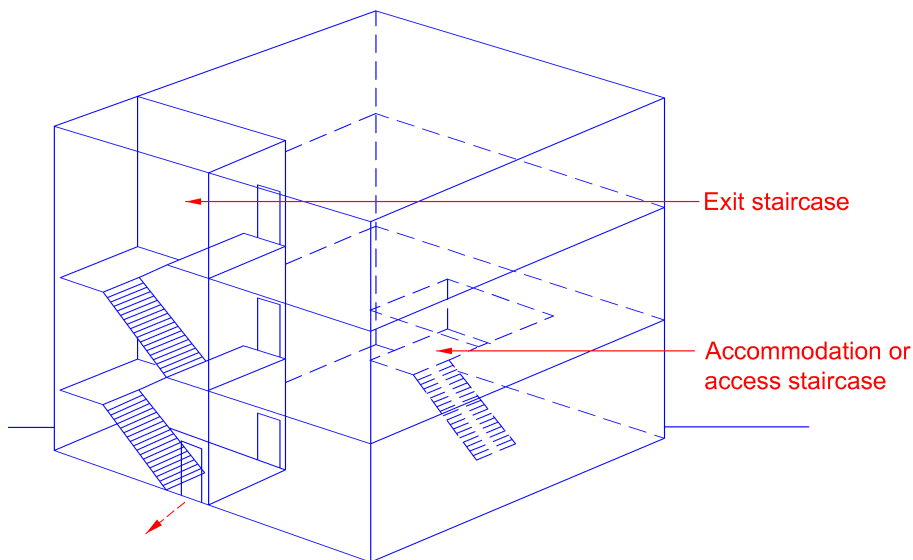

Diagram 1.2.27 – 3

Accommodation or access staircases are provided solely for the convenience of moving easily and quickly from one floor to another are **not considered** as exit staircases

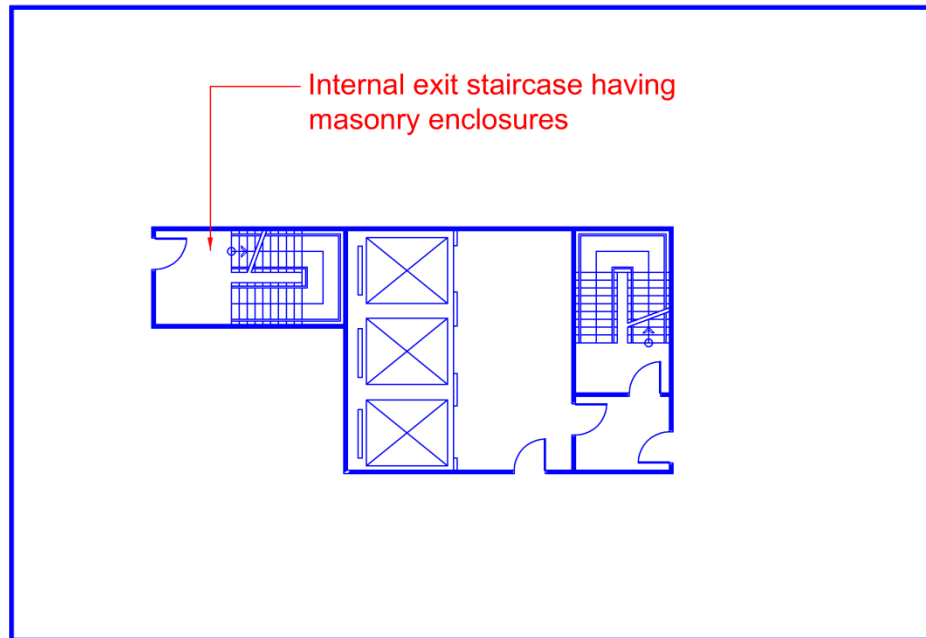

Diagram 1.2.27 - 4

*Internal exit staircases are required to be provided with masonry enclosures and mechanical ventilation. Masonry enclosures to internal exit staircases, mechanical ventilation is to be provided. Where the building exceeds 24m, the staircases are to be pressurized.*

*All exit staircases are considered as protected shafts are required to be separated from other areas by masonry walls to have the necessary fire resistance rating required by Cl. 3.3 for elements of structure for the part of the building in which they are located. Thus, the enclosures to staircases serving the basement would have higher fire resistance rating than that of staircases serving upper storeys. Door opening into the exit staircase shall have min. ½ hour fire resistance rating.*

# CHAPTER 1

## 1.2 DEFINITIONS

### 1.2.28 External cladding

Material fixed to the outside face of an external wall for weather protection or decorative purpose.

### EXPLANATIONS & ILLUSTRATIONS

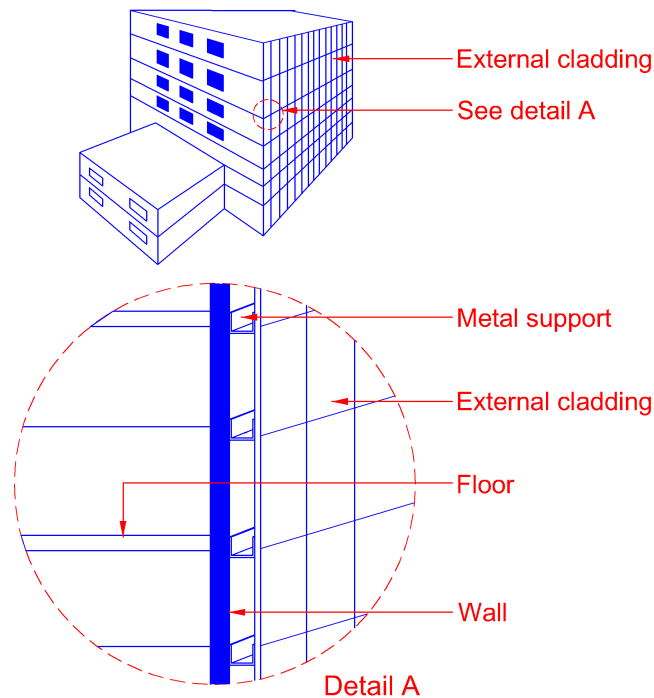

Diagram 1.2.28

*External claddings are usually provided to enhance the look of external walls of concrete or brick walls. The metal supports to the external cladding are not required to be fire-rated as they are not part of the elements of structure. Where the external cladding has any area of combustible material, 50% of that area shall be treated as “unprotected area” as defined under Cl.1.2.61*

*If external cladding contain plastic as the core material, the cladding shall pass the following tests :*

- 1) the plastic core shall achieve class “O” flame spread rating in accordance with BS 476 Part 6 standard; or*
- 2) the cladding shall pass UBC 26-9 standard*

*When such material is used, it shall have a backing material of at least 1 hr fire rating.*

# CHAPTER 1

## 1.2 DEFINITIONS

### 1.2.29 External exit staircase

- (a) An exit staircase which serves as a required exit shall be located outside the building and open to the outdoor air, and enclosed by parapet walls or railing only.
- (b) An external staircase shall qualify as an external exit staircase if it is located within or abutting an air-well (which is open to sky and is required to provide lighting and ventilation to the occupancy areas) having the minimum size in relation to the habitable height of the building as given in the Table 1.2.1A.

### EXPLANATIONS & ILLUSTRATIONS

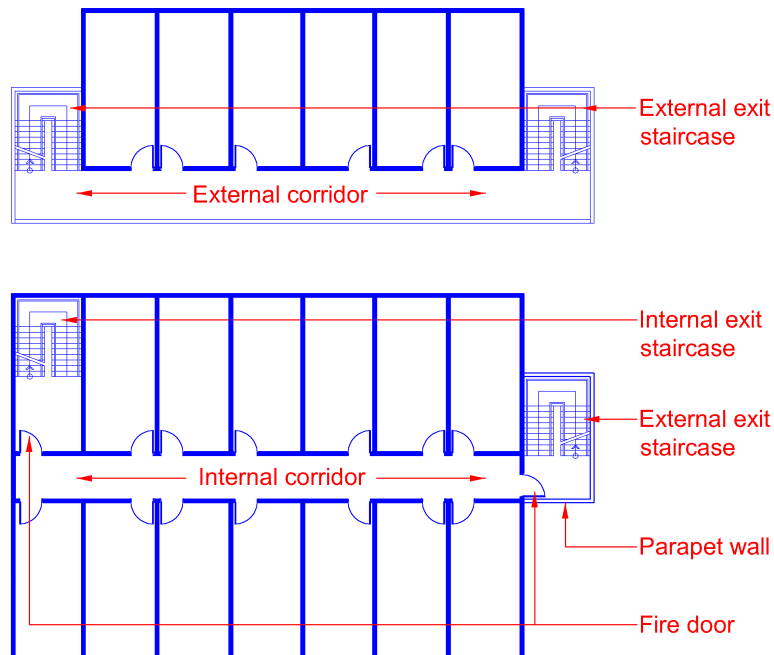

Diagram 1.2.29 - 1

See Cl.2.3.3(b) for requirements on separation of unprotected openings to external exit staircase and Cl.2.3.3(a) for protection of internal exit staircase.

For a staircase to be considered as external staircase, it shall be:

- (i) located outside the building;
- (ii) open to outdoor air
- (iii) at least 2 sides shall be enclosed by parapet or railing



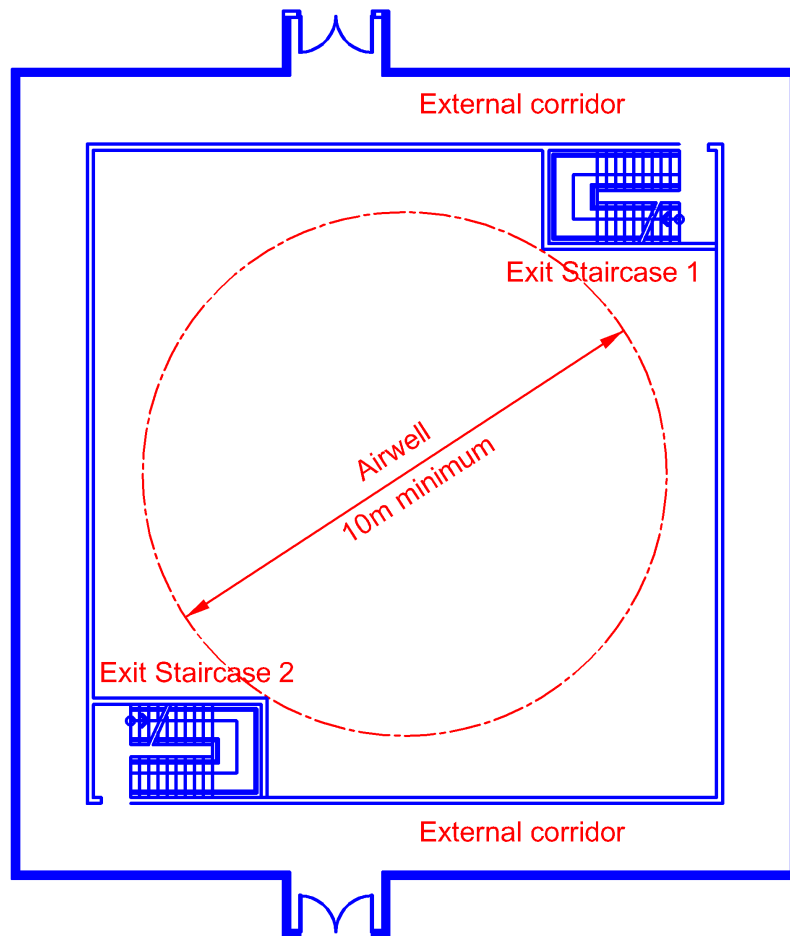

Diagram 1.2.29 - 2

*Siting of exit staircases or other services inside the airwell is considered acceptable, provided there is a clear unobstructed space having a diameter that is equal to the required width of the airwell i.e. if the required width of the airwell is 10m, then the diameter of the unobstructed space shall be min. 10m to allow for effective venting of hot gases and smoke.*

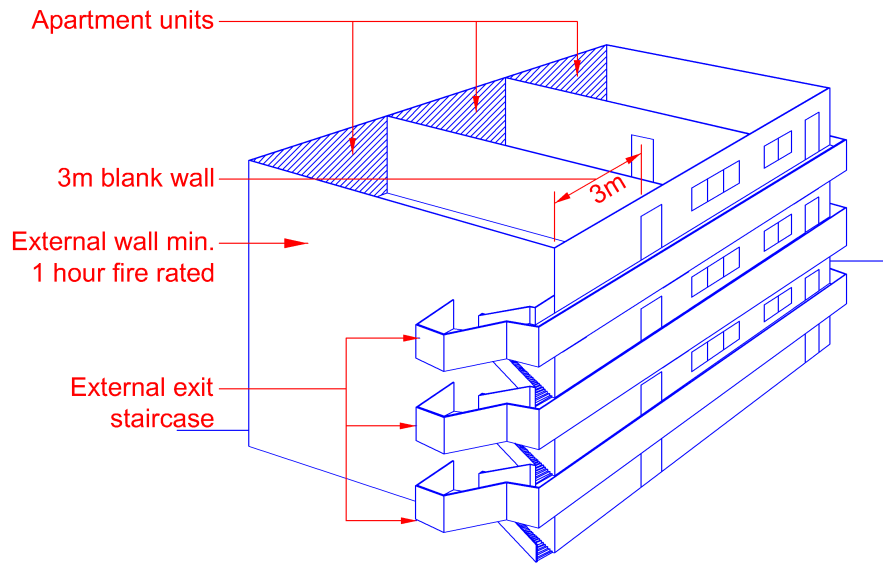

Diagram 1.2.29 - 3

*External exit staircase can be used as required exit in lieu of internal exit staircase, provided there shall be no unprotected openings within 3m horizontally or within 3m vertically below any part of the external exit staircase*

# CHAPTER 1

## 1.2 DEFINITIONS

### 1.2.30 External exit passageway

An exit passageway open to the outdoor air, that serves as a required exit.

External Exit Passageway shall comply with the provisions of C1.2.3.2(c).

### EXPLANATIONS & ILLUSTRATIONS

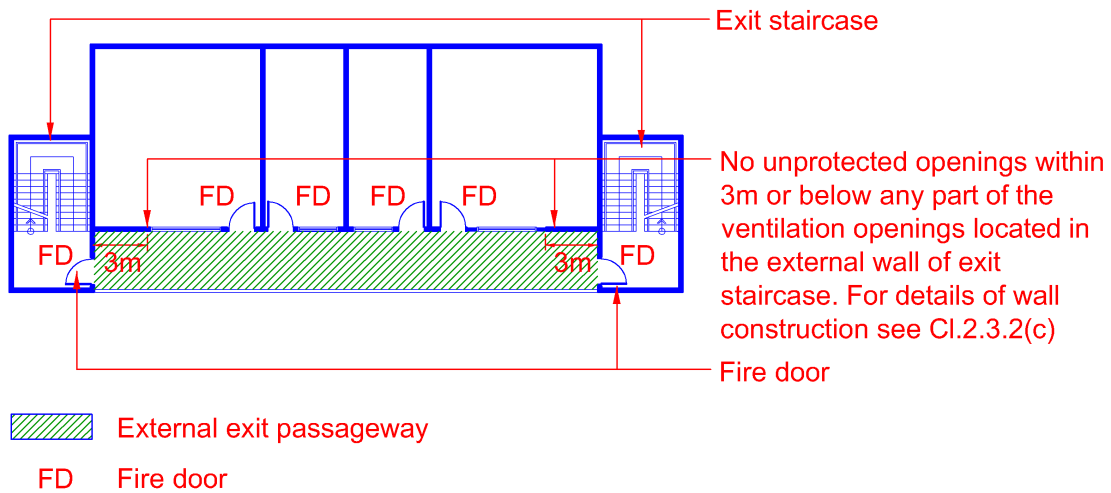

Plan

Diagram 1.2.30

*External exit passageway is an extension of the vertical exit. It is considered a protected area to allow occupants the safe egress. There is no control on the numbers of doors opening into an external exit passageway.*

# CHAPTER 1

## 1.2 DEFINITIONS

### 1.2.31 External wall (or side of a building)

An outer wall or vertical enclosure, including a part of the roof pitched at an angle of 70 degrees or more to the horizontal if that part of the roof adjoins a space within the building to which persons have access.

### EXPLANATIONS & ILLUSTRATIONS

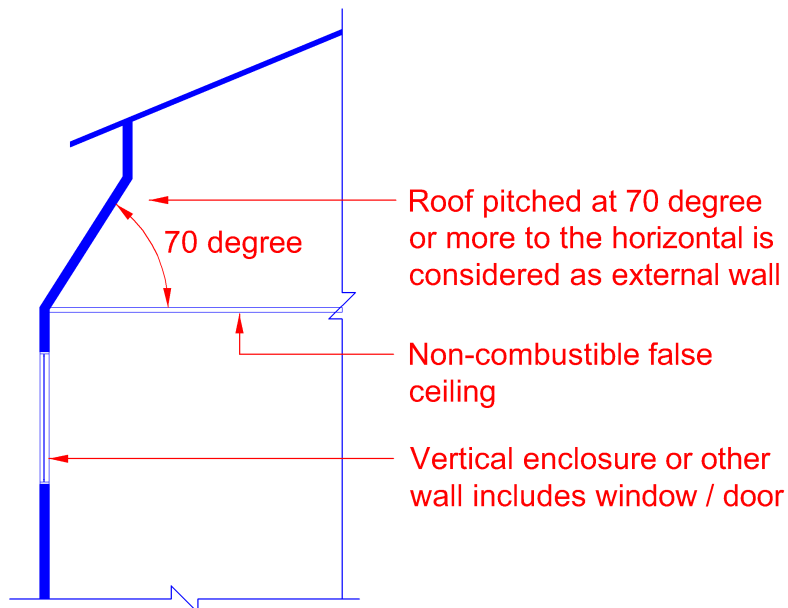

Section

*Diagram 1.2.31*

*Where that part of roof is treated as an external wall in accordance with the above definition, it shall comply with Cl.3.5 on the permitted limit of unprotected areas and the surface flame spread requirements. See also Cl.1.2.61 for the meaning of “unprotected areas”.*

# CHAPTER 1

## 1.2 DEFINITIONS

### 1.2.32 Fire resistance

The minimum period of time during which an element of structure or building element may be expected to function satisfactorily while subjected to a standard fire test.

### EXPLANATIONS & ILLUSTRATIONS

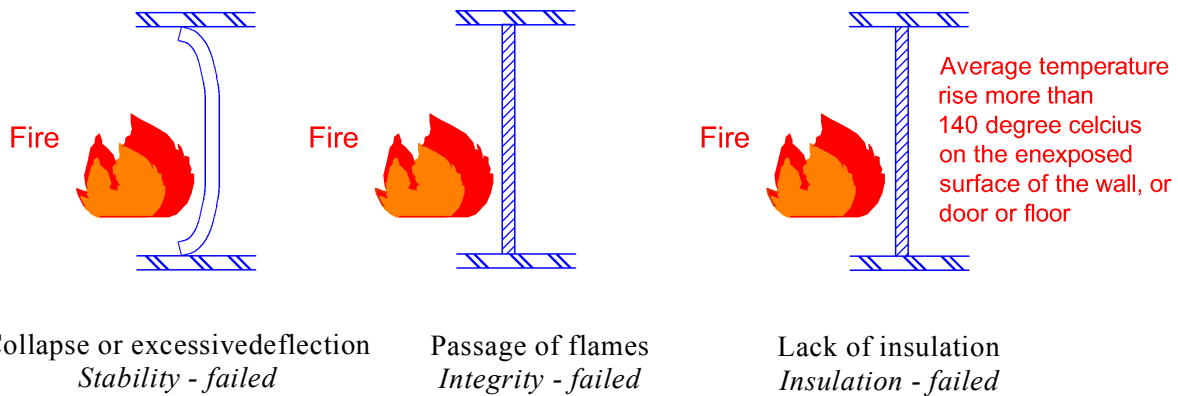

Diagram 1.2.32

Fire resistance is a property, currently measured in BS 476: part 20 to 23 furnace test, of a particular element of building construction (it is not a property of a building material) and is the measure of its ability to satisfy for a stated period in minutes some or all of the following criteria :

- *stability - resistance to collapse or excessive deflection*
- *integrity – resistance to passage of flames and hot gases*
- *Insulation – resistance to excessive temperature rise on exposed face*

# CHAPTER 1

## 1.2 DEFINITIONS

### 1.2.33 Fire stop

A seal provided to close an imperfection of fit or any joint between elements, components or construction in a building so as to prevent and restrict penetration of smoke and flame through that imperfection or joint.

### EXPLANATIONS & ILLUSTRATIONS

#### (i) Wall penetration details

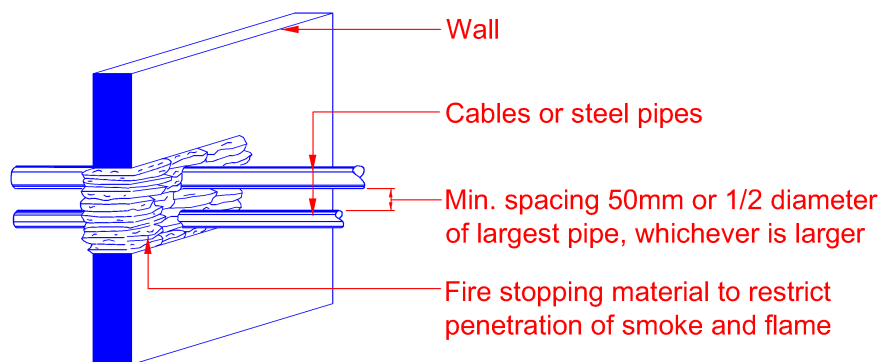

#### (ii) Floor penetration details

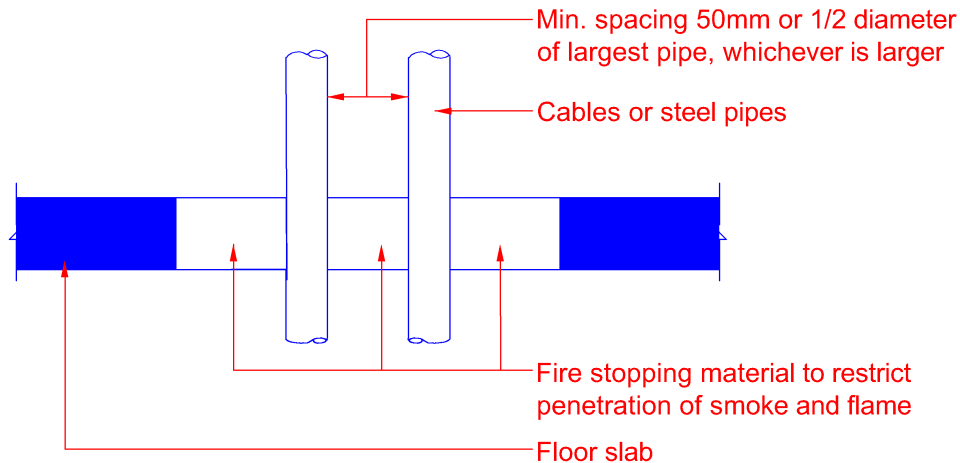
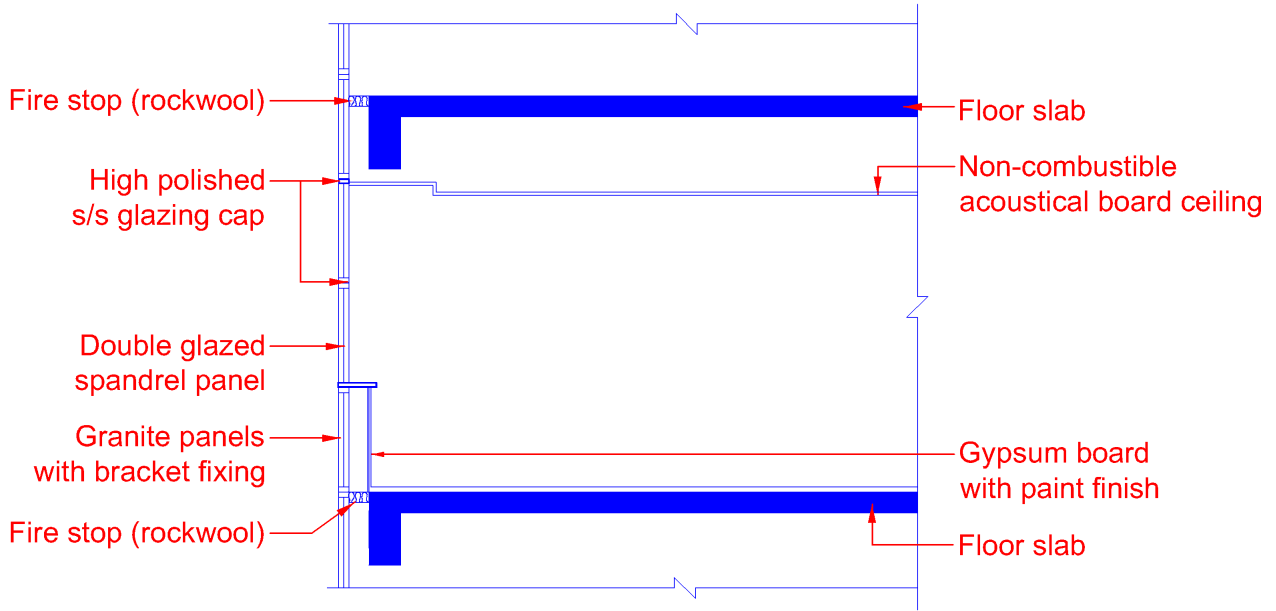

Diagram 1.2.33 - 1

To avoid weakening of the fire rated wall/floor, openings for service penetration should be :

- kept as few in number as possible;
- as small as practicable; and
- all gaps shall be filled with fire-stopping materials



*Diagram 1.2.33 -2*

Section - curtain walling detail

*It is important that the gap between the edge of the structural floor slab and the curtain wall should be fire stopped to prevent migration of smoke and flame from floor to floor*

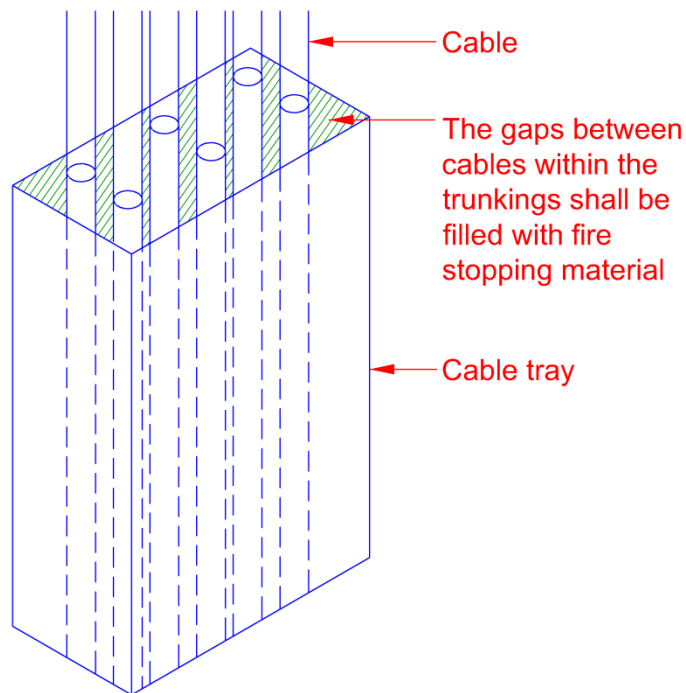

*Diagram 1.2.33 - 3*

# CHAPTER 1

## 1.2 DEFINITIONS

### 1.2.34 Fire-fighting lobby

A smoke-stop lobby which is adjacent to a fire lift and exit staircase designated for use by the fire fighting team during an emergency. The lobby shall not be used for any other purposes and the size of the lobby shall not be smaller than 6m<sup>2</sup> and with no dimension smaller than 2m.

### EXPLANATIONS & ILLUSTRATIONS

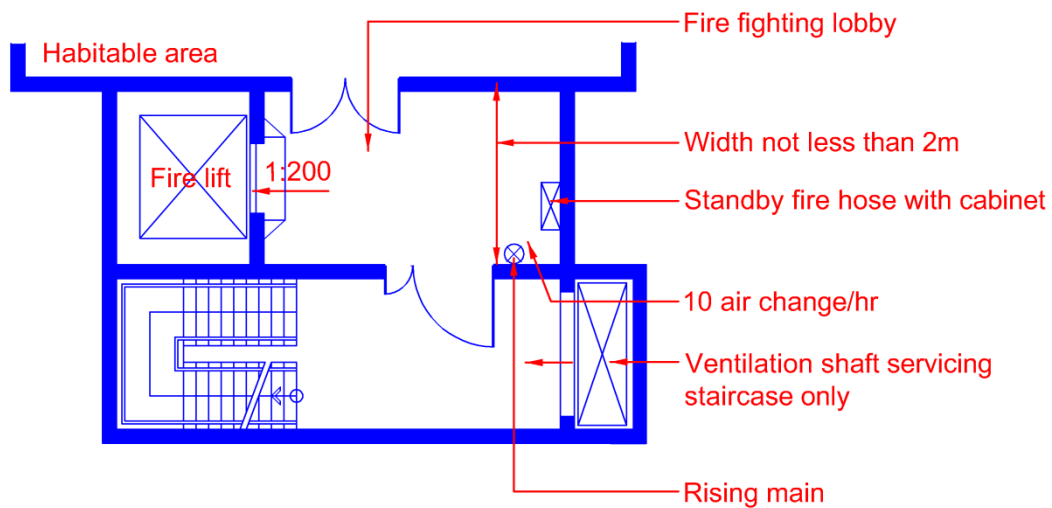

Plan

Diagram 1.2.34

The lobby floor shall be graded from the lift landing door towards the lobby door with a fall not exceeding 1: 200 to prevent water from flowing into the lift shaft. The lobby provides a buffer zone to prevent smoke from streaming into the protected staircase. The lobby acts as a staging area for fire fighters in carrying out fire fighting operation. There is a need to limit the size to max. 10 sq. m to prevent the space being used for other purposes. For mechanical ventilation requirement, see Cl.7.1.4.



# CHAPTER 1

## 1.2 DEFINITIONS

### 1.2.35 Flexible joints & connections

For air-conditioning and mechanical ventilation systems:

- (a) Flexible joints means connections between ducts and equipment normally provided to isolate vibration and to allow thermal movement.

### EXPLANATIONS & ILLUSTRATIONS

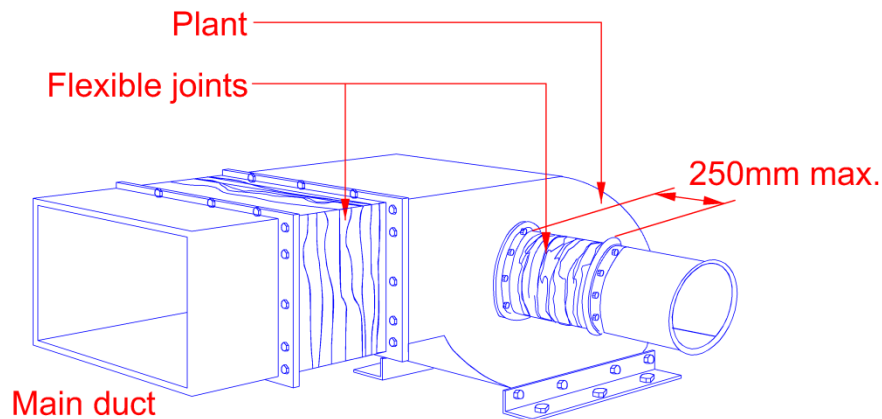

Diagram 1.2.35(a)

*Flexible joints shall not exceed 250mm in length and be made of materials classified as “not-easily-ignitable” when tested under BS 476 :PT 5*

(b) Flexible connections means flexible sections of ducts provided to connect the extremity of ventilation ductwork to terminal units, extract units and grilles.

## EXPLANATIONS & ILLUSTRATIONS

1.2.35

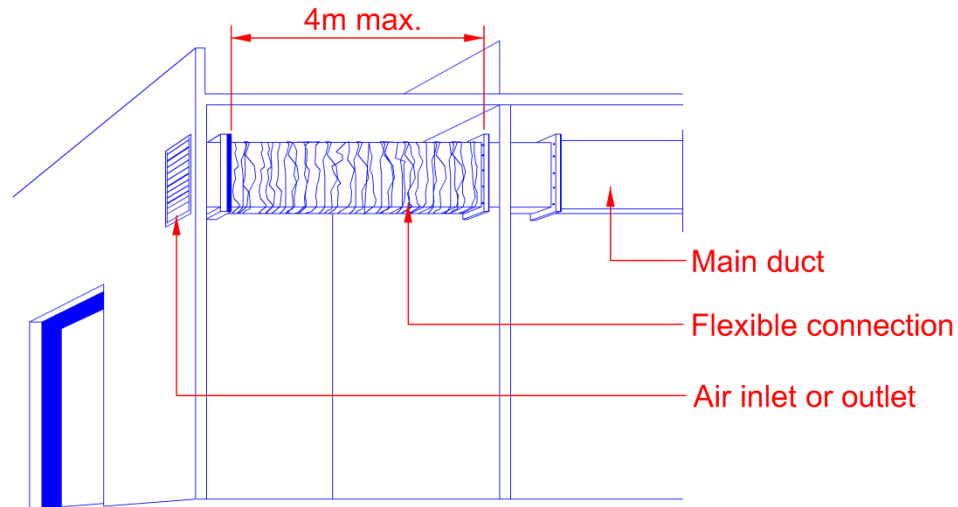

Diagram 1.2.35(b)

*Flexible connection material shall have a surface flame spread rating of not lower than class '1', but in areas of building where class '0' flame spread rating is required for the ceiling construction under Fire Code, a class '0' rating for the covering and lining materials shall be required. Flexible connection shall not exceed 4m in length. It shall not pass through fire resisting walls, floors or partitions and when involved in fire generates a minimum amount of smoke and toxic gases.*

# CHAPTER 1

## 1.2 DEFINITIONS

### 1.2.36 Habitable floor

A floor or part thereof, including roof level, regardless whether it is opened to sky or not, designated to be used for any purpose/activity other than housing lift motors, fire pumps, water supply pumps, cooling towers and water tanks. Such purpose/activity shall include terrace, garden and playground and other M & E plants.

### EXPLANATIONS & ILLUSTRATIONS

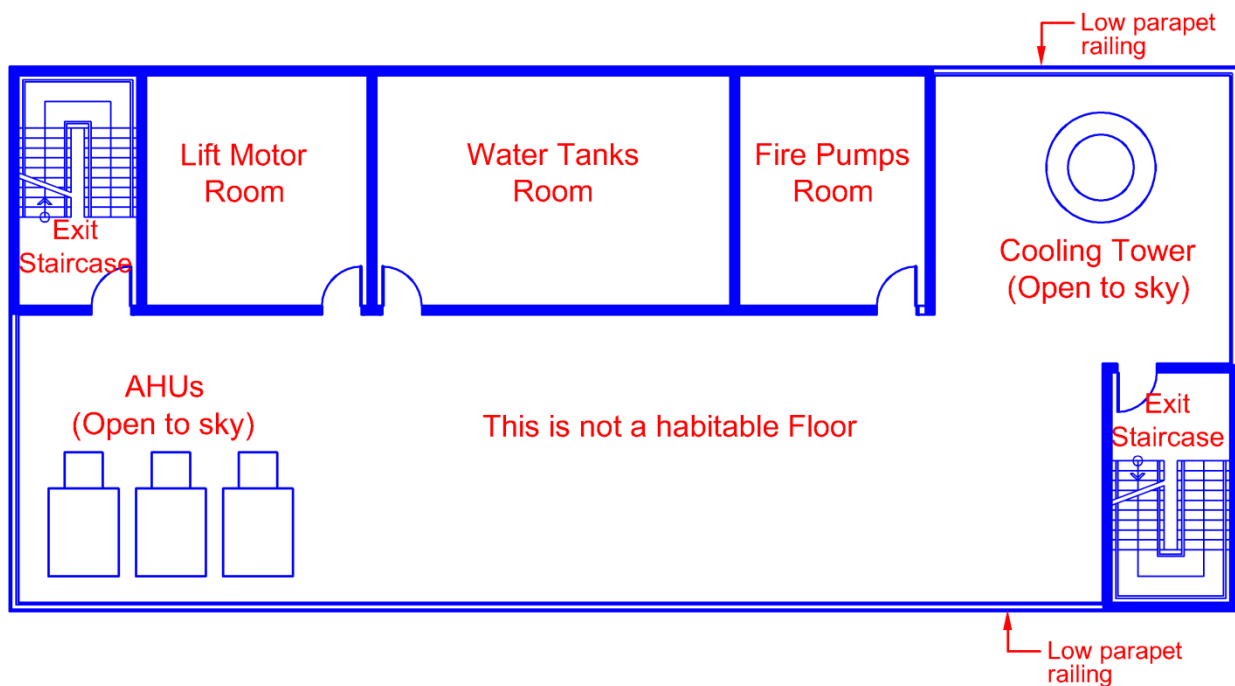

Diagram 1.2.36-1

*In the calculation of habitable height, rooms housing lift motors, fire pumps, water supply pumps, cooling towers and water tanks located on roof level irrespective of the room sizes are not considered as habitable floor.*

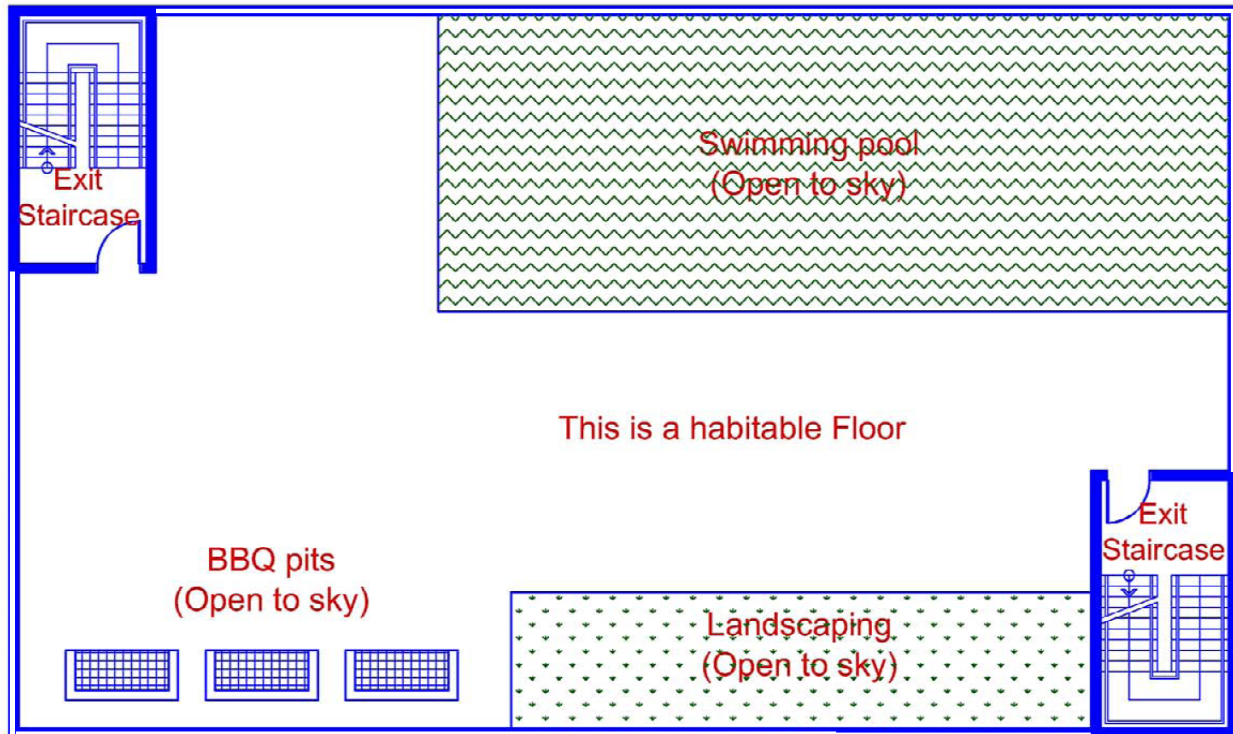

Diagram 1.2.36-2

*In all other situation where the floor level has a functional usage in a room or open to sky, it will be a habitable floor.*

# CHAPTER 1

## 1.2 DEFINITIONS

### 1.2.37 Habitable height

The habitable height is the height measured from the lowest level of fire engine accessway or access road (applicable to buildings under purpose group II) to the finished floor level of the highest habitable floor.

### EXPLANATIONS & ILLUSTRATIONS

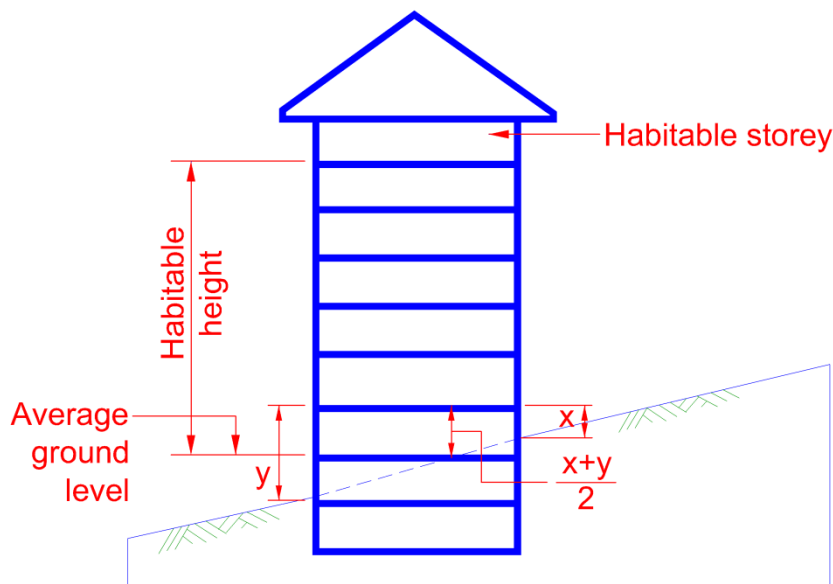

Section

Diagram 1.2.37

Habitable height is measured from the average ground level adjoining the building to the finished floor level of the highest habitable floor. Where attic is permitted under Cl.2.4.12, the habitable height would be extended to the finished floor level of the attic. Habitable height is used to determine the provision of fire protection system and other related requirements to a building. If the habitable height of a building exceeds 24m, the following shall be provided :

- Rising mains
- Sprinkler system\*
- Fire lift/Fire command centre\*
- Voice communication system\*
- Alarm system
- Pressurization of internal exit staircases

\*not required for purpose group II building, unless requested by the Relevant Authority

# CHAPTER 1

## 1.2 DEFINITIONS

### 1.2.38 Height of building

The height of building or (where relevant) of part of a building as described in the Code, means the height of such building or part, measured from the average level of the ground adjoining the outside of the external walls of the building to the level of half the vertical height of the roof of the building or part, or the top of the walls or of the parapet (if any), whichever is the higher.

### EXPLANATIONS & ILLUSTRATIONS

a) Average ground level to half the vertical height of the pitch roof

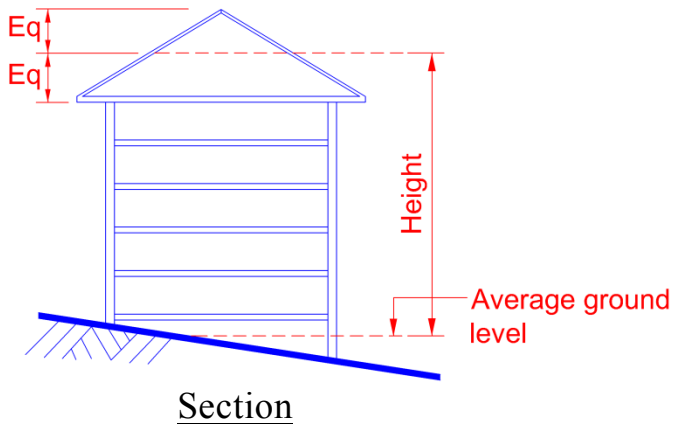

b) Average ground level to flat roof and the top of walls of parapet

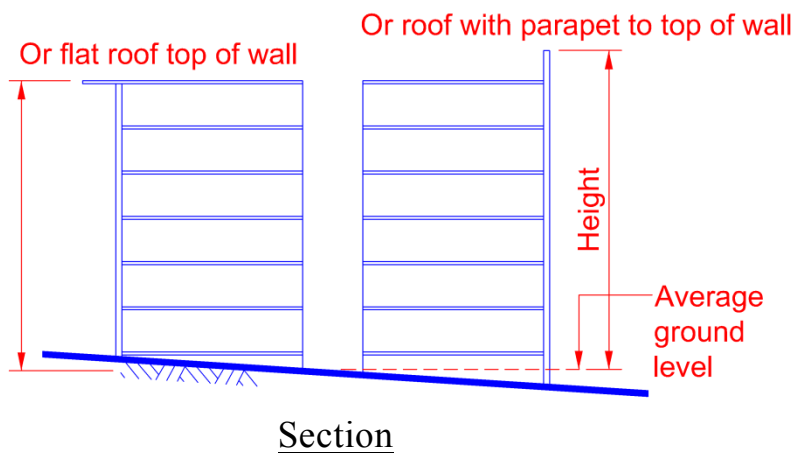

*c) Average ground level to half the vertical height of the pitch roof of a part of a building*

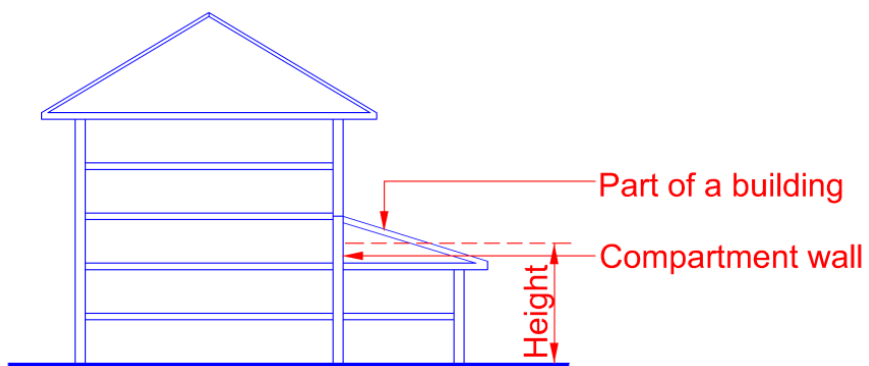

Section

*Diagram 1.2.38 - 3*

# CHAPTER 1

## 1.2 DEFINITIONS

### 1.2.39 High hazard occupancy

Any occupancy in which the contents or activities include one or more of the following:

- (a) materials that will flame up by themselves without the presence of any fire source below the ignition temperature of 200°C,
- (b) materials that would produce poisonous, noxious fumes, or flammable vapour,
- (c) materials that would cause explosions,
- (d) extra high hazard occupancies classified under SS CP 52, and
- (e) highly combustible substances and flammable liquids.

### EXPLANATIONS & ILLUSTRATIONS

*No illustration.*



# CHAPTER 1

## 1.2 DEFINITIONS

### 1.2.42 Non-combustible material

Non-combustible material means any material which neither burns nor gives off flammable vapour in sufficient quantity to ignite when subjected to the test for combustibility prescribed in BS 476 Part 4, and includes materials of limited combustibility, such as:

- (a) Any material of density  $300 \text{ kg/m}^3$  or more, which when tested to BS 476: Part 11, does not flame and the rise in temperature on the furnace thermocouple is not more than  $20^\circ\text{C}$ ;
- (b) Any material with a non-combustible core at least 8mm thick having combustible facings (on one or both sides) not more than 0.5mm thick; and
- (c) Any material of density less than  $300 \text{ kg/m}^3$ , which when tested to BS 476: Part 11, does not flame for more than 10 seconds and the rise in temperature on the centre (specimen) thermocouple is not more than  $35^\circ\text{C}$  and on the furnace thermocouple is not more than  $25^\circ\text{C}$ .
- (d) Any materials that can achieve class A1 or A2 in accordance with EN 13501 standard.

### EXPLANATIONS & ILLUSTRATIONS

*Material can also be considered as non-combustible or limited combustibility achieving Class "A1" or "A2" in accordance with EN 13501 Standard.*

# CHAPTER 1

## 1.2 DEFINITIONS

### 1.2.44 Notional boundary

Boundary presumed to exist for the purpose of this document between buildings on the same site.

#### EXPLANATIONS & ILLUSTRATIONS

a) *Notional boundary between 2 tower blocks, either sitting on podium deck or ground level*

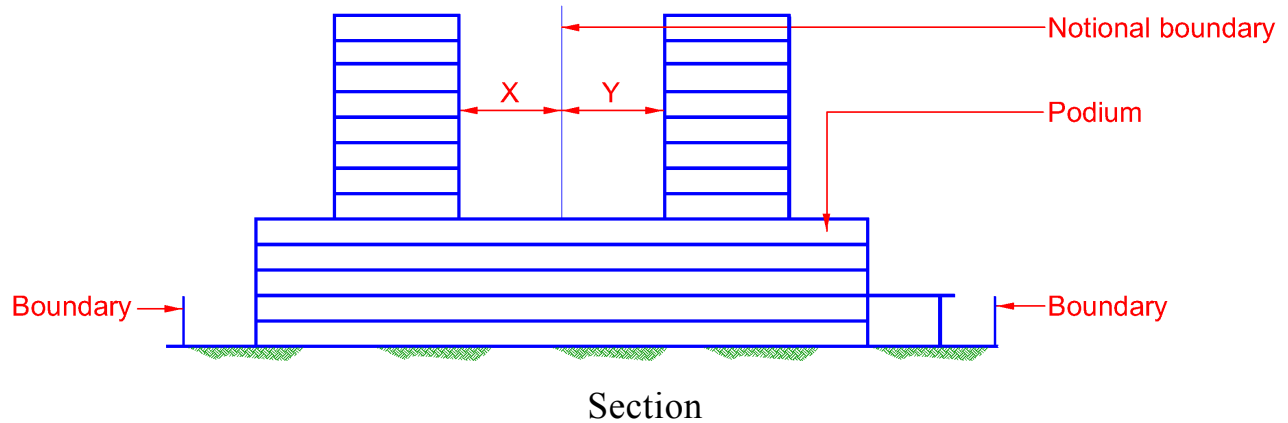

Diagram 1.2.44 - 1

b) *Notional boundary between a warehouse and factory sited within a development plot of land bounded by common boundaries.*

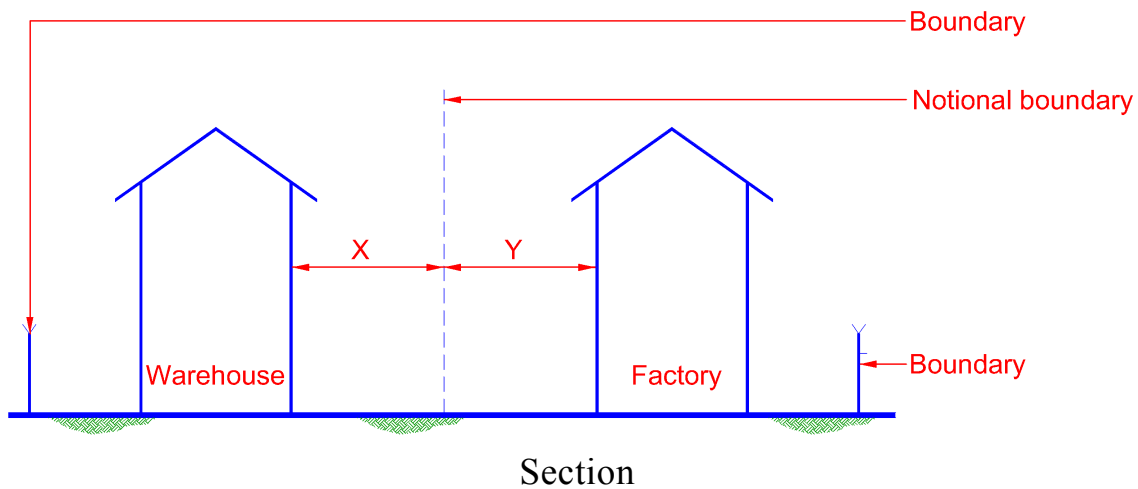

Diagram 1.2.44 - 2

*The extent of unprotected openings eg. windows in the external wall of a building is controlled by the space separation between the building and the boundary. The greater the building setback, the higher the extent of unprotected openings that would be allowed in the external wall. This is to address the concern of spread of fire from one building to another. The use of the boundary instead of another building makes it possible to work out the extent of unprotected openings even where another building does not exist.*

**EXPLANATIONS & ILLUSTRATIONS****1.2.44**

*In some situations, the distance to other building on the same site needs to be considered to prevent spread of fire. This is done by assuming a boundary called notional boundary. A notional boundary should be so situated that all buildings comply with the safe distance requirements as annotated in X and Y in the above diagrams. The boundary, which a wall faces (at an angle of 80° C or less) whether it is the boundary of the site or a notional boundary is called the relevant boundary.*

*In the diagram, if the total setback distance for warehouse and factory is more than or equal to  $X + Y$ , then the setback distance is considered complied with provided that both buildings are within the same lot.*

# CHAPTER 1

## 1.2 DEFINITIONS

### 1.2.45 Occupant load

The "occupant load" of a building or part thereof means the total number of persons that may occupy such building or part thereof at any one time. The "occupant load" shall be established:

- (a) by applying to the floor areas available for occupation based on the appropriate areas as per person as laid down in Table 1.2A, or
- (b) by number fixed seating, if applicable, for Assembly Occupancies.

### EXPLANATIONS & ILLUSTRATIONS

a) *Table 1.2A gives a range of occupant load factors. To calculate the occupant load of a floor space for example an office, apply the formula :*

$$\begin{aligned} \text{Occupant load} &= \frac{\text{Floor area office (1000sq.m)}}{\text{Occupant load factor for office (10sq.m)}} \\ &= \frac{1000\text{m}^2}{10 \text{ person/m}^2} \\ &= 100 \text{ persons} \end{aligned}$$

- b) (i) *the occupant load for theatre or cinema where there is fixed seating, the posted occupant load based on number of seats can be taken.*
- (ii) *the back stage areas shall be separately calculated based on floor area.*
- (iii) *Where there are spaces provided for flexible seating, the occupant load for these spaces shall be separately calculated based on floor area.*

# CHAPTER 1

## 1.2 DEFINITIONS

### 1.2.46 Permitted limit of unprotected area

The maximum aggregate area of unprotected areas in any side or external wall of a building or compartment as referred to in Cl.3.5.3.

### EXPLANATIONS & ILLUSTRATIONS

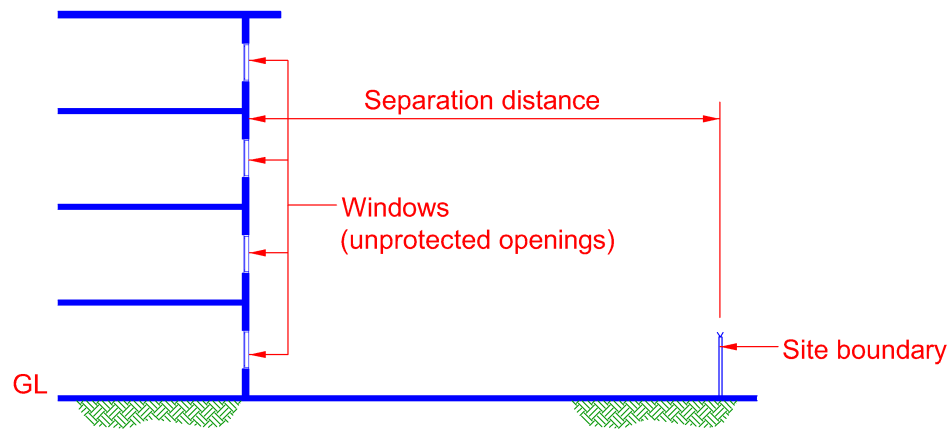

Diagram 1.2.46

*The main concern of unprotected openings in external walls is to ensure that spread of fire through heat radiation from one building to another would be minimised. However, Cl.3.5.3 does permit relaxation for buildings, which are sprinklered protected or solely used as car parks.*

# CHAPTER 1

## 1.2 DEFINITIONS

### 1.2.46(A) Private lift

Private lifts are passenger lifts which are meant for the exclusive use of occupants in the building, and are located to open its door directly into private enclosed spaces. Private lifts shall exclude vehicle lifts, home lifts and stair lifts.

### EXPLANATIONS & ILLUSTRATIONS

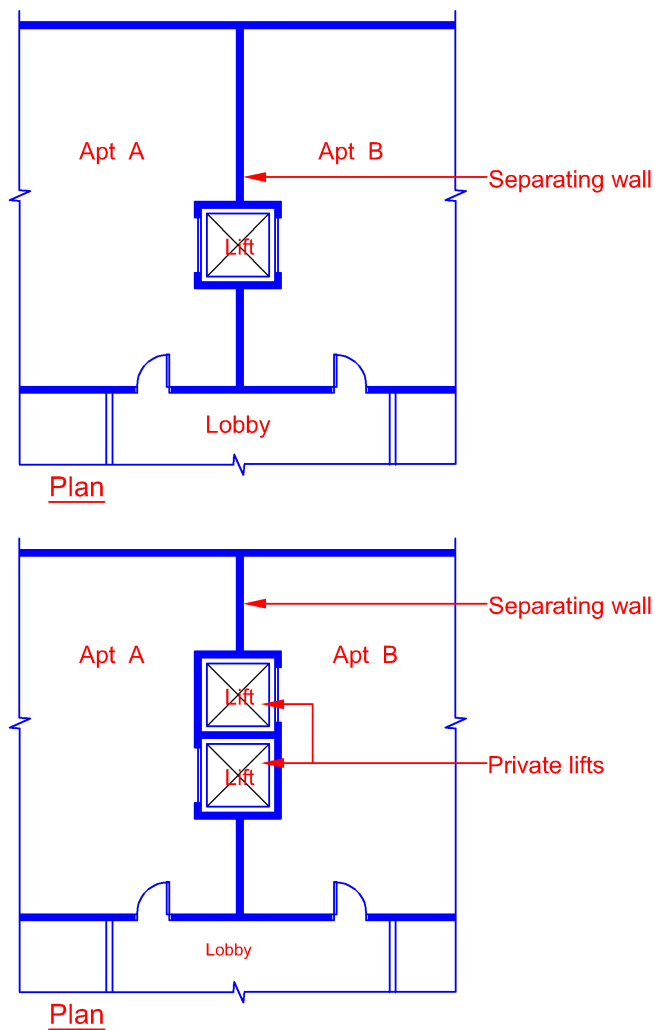

Diagram 1.2.46(A)

*Emergency power supply from a generating plant shall be provided to home the private lifts to the designated floor during power failure in the building. For more info, please refer to Cl 3.8.8(h)*

# CHAPTER 1

## 1.2 DEFINITIONS

### 1.2.47 Protected shaft

An exit staircase, exit passageway, lift, chute, duct or other shaft which enables persons or things or air to pass from one compartment to another.

### EXPLANATIONS & ILLUSTRATIONS

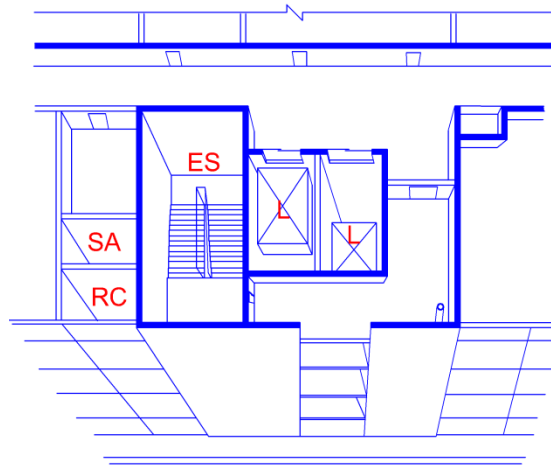

**LEGEND:**

SA = Supply air shaft

RC = Refuse chute

ES = Exit staircase

L = Lift shaft

Some examples of protected shafts

*Diagram 1.2.47*

# CHAPTER 1

## 1.2 DEFINITIONS

### 1.2.48 Protecting structure

Wall, floor or other part of the building which encloses a protected shaft, but not:

- (a) A wall which also forms part of an external wall, separating wall or compartment wall, or
- (b) A floor which is also a compartment floor or a floor laid directly on the ground, or
- (c) A roof.

### EXPLANATIONS & ILLUSTRATIONS

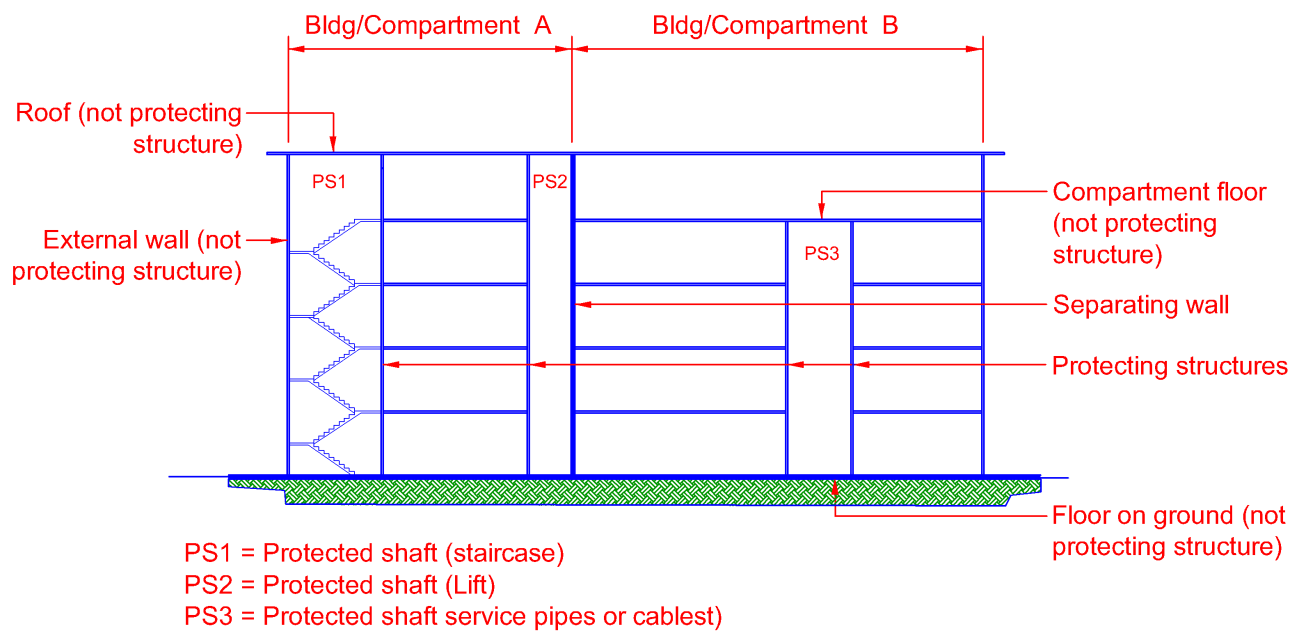

#### Section

Diagram 1.2.48

*There is a need to differentiate protecting structure to shaft from other elements of structures such as compartment walls, separating walls and external walls. This is for the purpose of working out differently the necessary period of fire resistance rating to the protecting structures. For example, Cl.3.8.6 permits door to protected shaft to have ½ the period of fire resistance rating of the enclosing protecting structures to an exit staircase.*



# CHAPTER 1

## 1.2 DEFINITIONS

<b>1.2.49 Public building</b>	
Public building means a building or part thereof used or constructed or adapted to be used as a shop, office, hospital or place of public resort, not being a church, chapel, mosque, temple or other place where public worship is or religious ceremonies are performed.	
<b>EXPLANATIONS &amp; ILLUSTRATIONS</b>	
<i>No illustration</i>	

# CHAPTER 1

## 1.2 DEFINITIONS

### 1.2.50 Purpose group

For the purpose of this document, every building or compartment shall be regarded according to its use or intended use as falling within one of the purpose groups set out in Table 1.2B. For designation of purpose group, where a building is divided into compartments used or intended to be used for different purposes, the purpose group of each compartment shall be determined separately, provided that where the whole or part of a building or compartment (as the case may be) is used or intended to be used for more than one purpose, only the main purpose of use of that building or compartment shall be taken into account in determining into which purpose group it falls.

Remarks: Requirements for buildings not covered in Table 1.2B, including but not limited to Power Stations, Telecommunication Exchanges, Incinerator Buildings, Wood Working Buildings, Rubber Factory Buildings, Matches and Fire Works Factories, Glass Factories, Chemical Plants, Petroleum Refineries and Buildings used for the manufacture and storage of Highly Combustible Substances and Flammable Liquids, etc shall be consulted with the Relevant Authority.

### EXPLANATIONS & ILLUSTRATIONS

a) *For the purpose of complying with fire safety requirements under this code, every building or compartment shall be treated according to its use or intended use as prescribed under Table 1.2B*

b) *Flatted factory building*

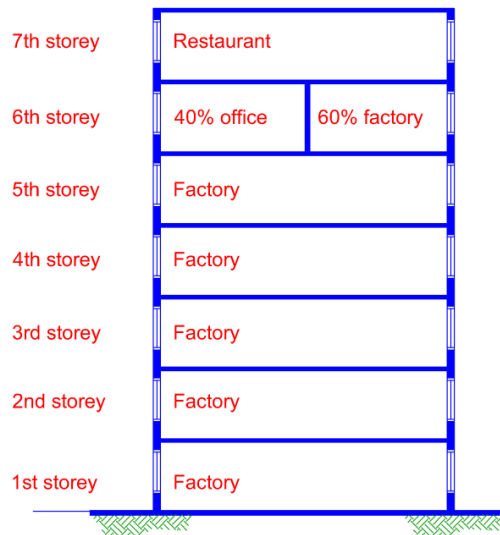

Section

Diagram 1.2.50

*Each floor is a compartment with 6<sup>th</sup> storey being further divided into 2 compartments, having 40% office and 60% factory use. The main purpose of use of 6<sup>th</sup> storey is factory, thus 6<sup>th</sup> storey is to be treated as factory use. Similarly, a building may have shops, offices and restaurants, but it is classified as shopping centre as the main purpose of use of the building is shopping.*

c) Townhouses

*Under the Fire Safety (Exemption) order 1994, proposal for detached, semi-detached, terraced and linked houses which do not exceed 3 storeys or levels, including basement or attic are not required to be submitted to FSSD for approval. The QP in charge of the project shall self-regulate to ensure that all relevant fire safety requirements are complied with on site. However, townhouses, which are treated as under purpose group I for the purpose of complying with fire safety requirements that are applicable to detached, semi-detached terraced and linked houses, are not covered by the Fire Safety (Exemption) Order 1994, hence, submission of plans to FSSD is required.*

d) Serviced apartments/maisonettes

*Serviced apartments/maisonettes would be treated as hotels or boarding houses under purpose group VII at the outset. However, FSSD may consider to reclassify it under purpose group II if the floor layout of the units and escape corridors is similar to that of a typical apartments/maisonettes building.*

# CHAPTER 1

## 1.2 DEFINITIONS

<b>1.2.51 Relevant Authority</b>	
Relevant Authority means the Commissioner of Singapore Civil Defence Force and includes officers authorised by him generally or specifically to exercise the powers, functions and duties conferred by the Fire Safety Act.	
<b>EXPLANATIONS &amp; ILLUSTRATIONS</b>	
<i>No illustration</i>	

# CHAPTER 1

## 1.2 DEFINITIONS

### 1.2.52 Relevant boundary

Boundary in relation to a side or external wall of a building or compartment, including a notional boundary.

### EXPLANATIONS & ILLUSTRATIONS

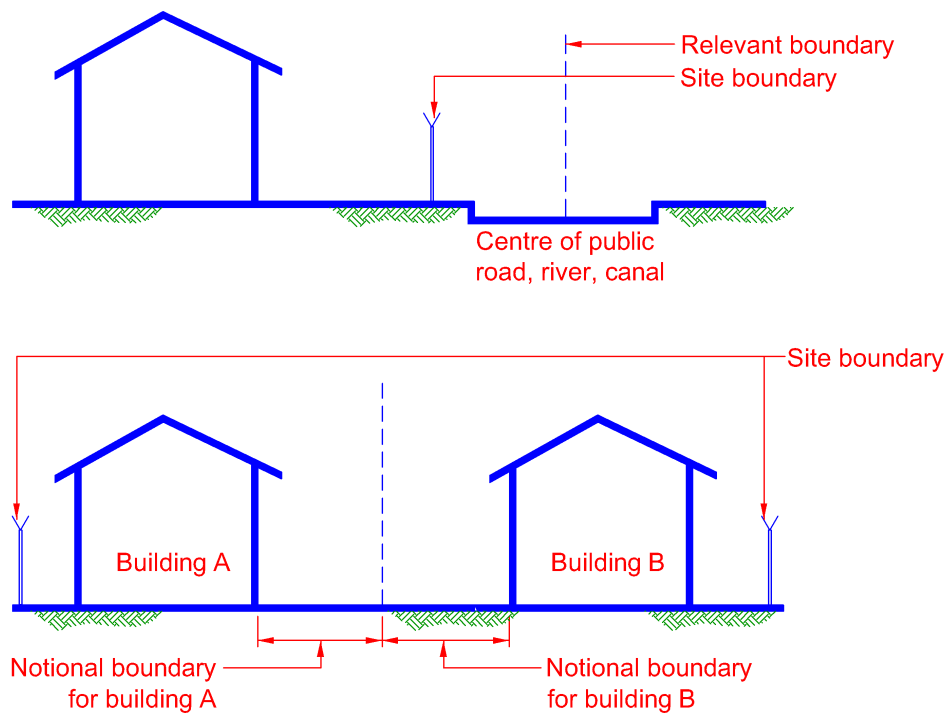

Section

*Diagram 1.2.52*

*The boundary which a side or external wall of a building faces whether it is the boundary of the site or a notional boundary is called the relevant boundary.*

# CHAPTER 1

## 1.2 DEFINITIONS

### 1.2.53 Roof light

Includes any domelight, lantern light, skylight or other element intended to admit daylight.

### EXPLANATIONS & ILLUSTRATIONS

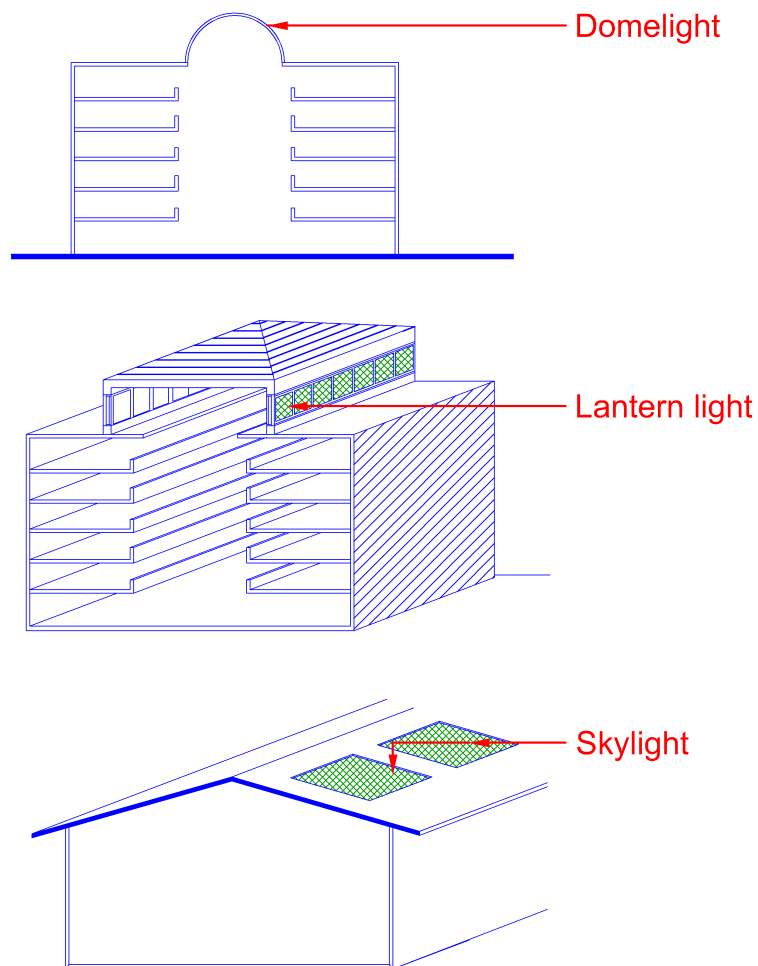

Section

Diagram 1.2.53

*Rooflights are part of roof coverings, which permit light to enter a building to provide natural lighting. Rooflights could be designed to be openable by automatic devices to provide the necessary openings for smoke venting. The inner surface of dome light and skylight is considered as ceiling for the purpose of meeting the class of surface flame spread under Cl.3.13.5(b).*

# CHAPTER 1

## 1.2 DEFINITIONS

### 1.2.54 Room

An enclosed space in a building that is not an enclosed circulation space or a protected shaft or an enclosed space not exceeding 750mm in depth.

### EXPLANATIONS & ILLUSTRATIONS

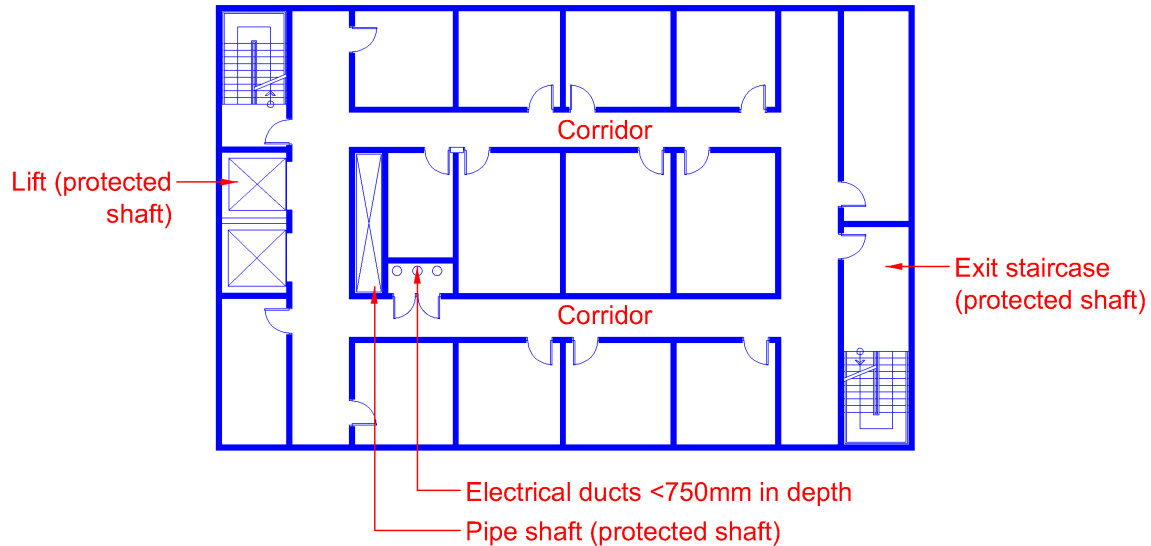

Section

Diagram 1.2.54 - 1

An enclosed space not considered as a room include exit staircase (protected shaft), enclosed circulation space such as A/C, MV shafts, pipe/cable shafts and accessible electrical ducts not exceeding 750mm in depth.

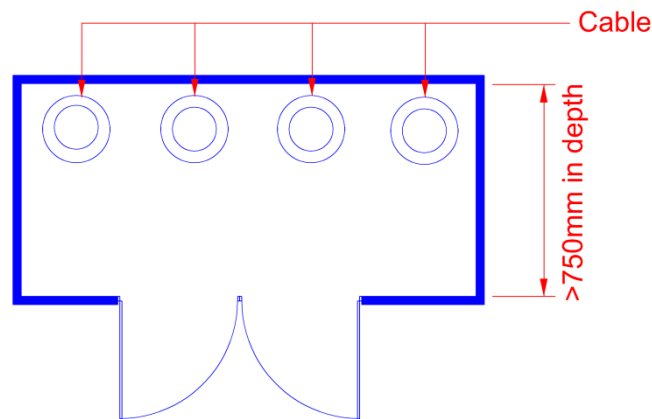

Section

Diagram 1.2.54 - 2

An electrical riser having a depth of >750mm is considered a room

# CHAPTER 1

## 1.2 DEFINITIONS

### 1.2.55 Separated part of a building

A form of compartmentation that is a part which is separated from another part of the same building by a compartment wall which runs full height of the part and is in one continuous plane.

### EXPLANATIONS & ILLUSTRATIONS

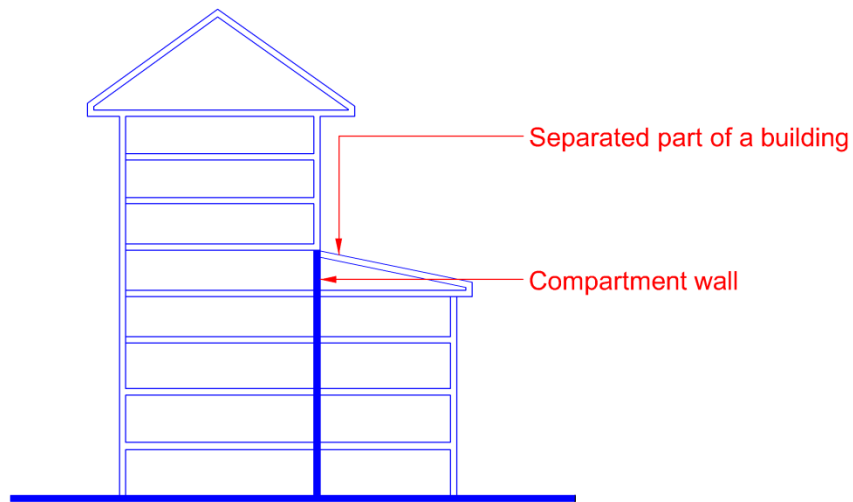

Section

*Diagram 1.2.55*



# CHAPTER 1

## 1.2 DEFINITIONS

### 1.2.56 Separating wall

A wall separating adjoining buildings.

### EXPLANATIONS & ILLUSTRATIONS

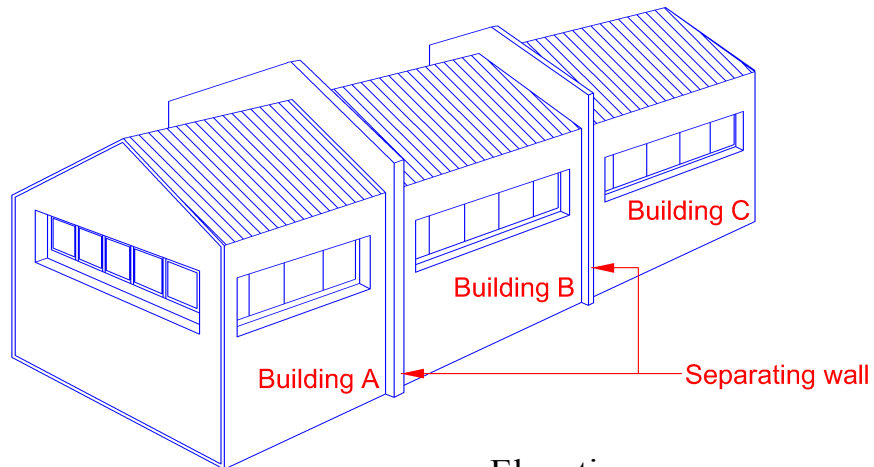

Elevation

*Diagram 1.2.56*

# CHAPTER 1

## 1.2 DEFINITIONS

### 1.2.57 Smoke check door

A door or set of doors placed in an internal corridor to restrict the spread of smoke by reducing draft.

### EXPLANATIONS & ILLUSTRATIONS

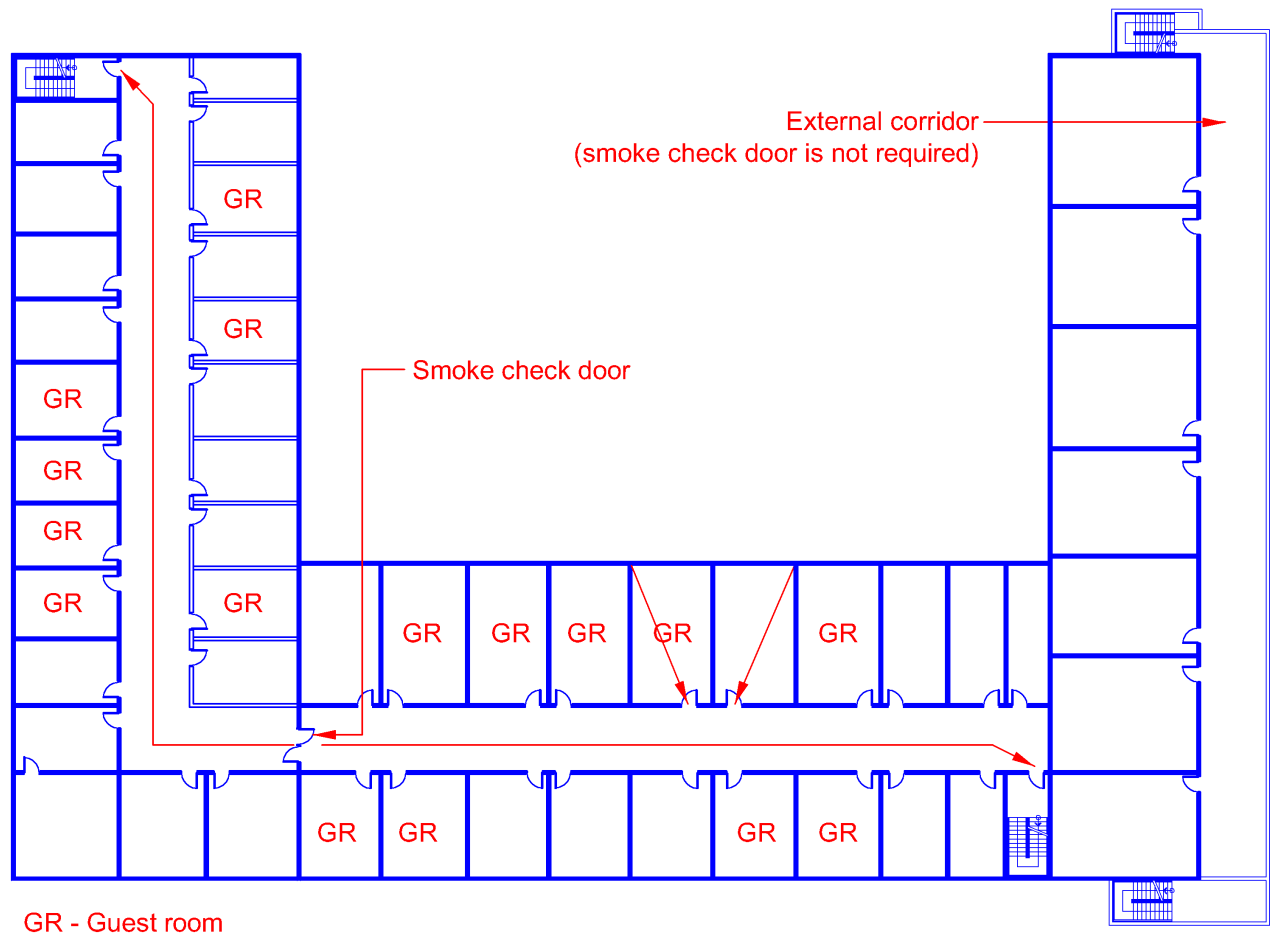

Section

Diagram 1.2.57

The provision of smoke check door is applicable to **hotel occupancy**. It is provided to subdivide the internal corridor to the hotel guest rooms floor into the following lengths :

- a) Building protected by sprinkler system --- 45m
- b) Building not protected by sprinklered system --- 30m

Internal corridors which are not naturally ventilated shall be subdivided by smoke barrier and smoke check door to prevent the whole corridor being filled with smoke very quickly should there be any migration of smoke from any guestroom. Smoke check door is not required to have fire resistance rating.

# CHAPTER 1

## 1.2 DEFINITIONS

### 1.2.58 Smoke-stop lobby

A lobby located at the entrance to an exit staircase to help to prevent or minimise the entry of smoke into the staircase. The size of the lobby shall not be smaller than 3m<sup>2</sup>.

### EXPLANATIONS & ILLUSTRATIONS

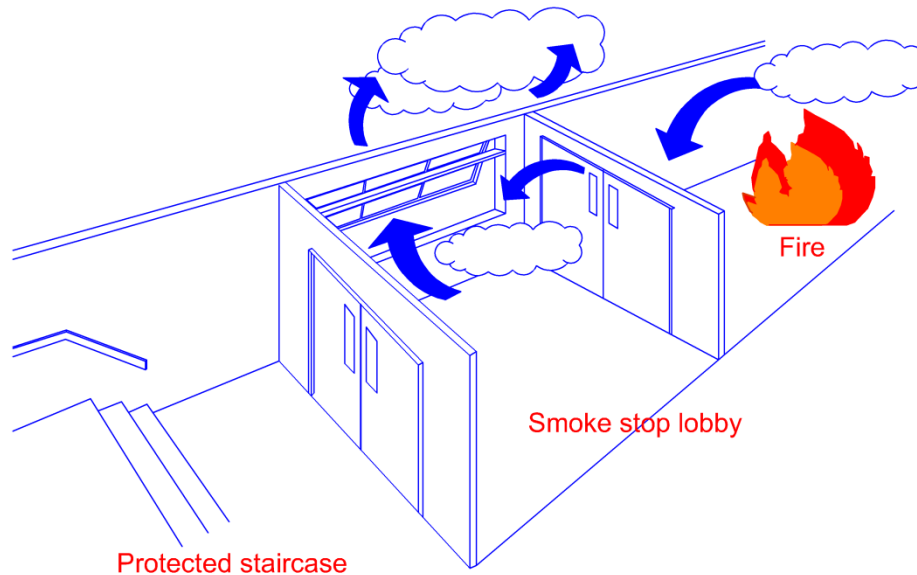

Diagram 1.2.58

*If smoke which finds its way into the smoke-stop lobby, the natural ventilation provided by the window will help to prevent the smoke from infiltrating into the protected staircase. In the case of mechanical ventilated smoke-stop lobby, smoke will be prevented from entering the lobby by the exertion of air pumped into it by the air shaft.*

# CHAPTER 1

## 1.2 DEFINITIONS

### 1.2.58(A) Tenancy unit

Tenancy unit refers to an individual unit or subdivided unit within a building or a compartment, and which is managed by a different operator registered with the Accounting and Corporate Regulatory Authority (ACRA).

### EXPLANATIONS & ILLUSTRATIONS

#### Typical storey plan of Factory / Warehouse building

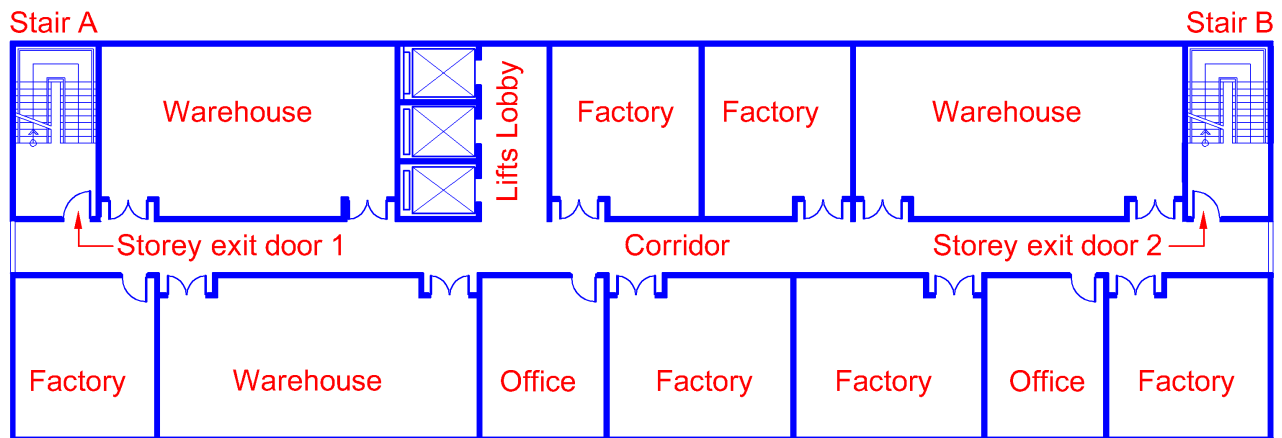

*Diagram 1.2.58(A)*

# CHAPTER 1

## 1.2 DEFINITIONS

### 1.2.59 TRAVEL DISTANCE

The distance required to be traversed from the most remote point in any room or space to the edge of a door opening directly to –

- an exit staircase, or
- an exit passageway, or
- an open exterior space,

unless otherwise permitted under this Code as in the case of hotel bedrooms (Cl.2.7.3), residential apartments or maisonettes (Cl.2.4.7) and exit to Area of Refuge (Cl. 2.2.6(f)).

### EXPLANATIONS & ILLUSTRATIONS

a) *Measurement starts at 400mm from enclosure of wall*

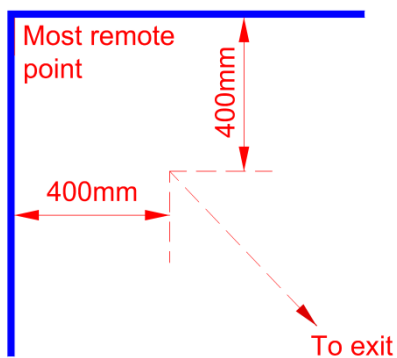

*Diagram 1.2.59 - 1*

b) *Travel distance from the most remote point to open exterior space. Travel distance shall be measured to the door of the exit staircase i.e from point A to B*

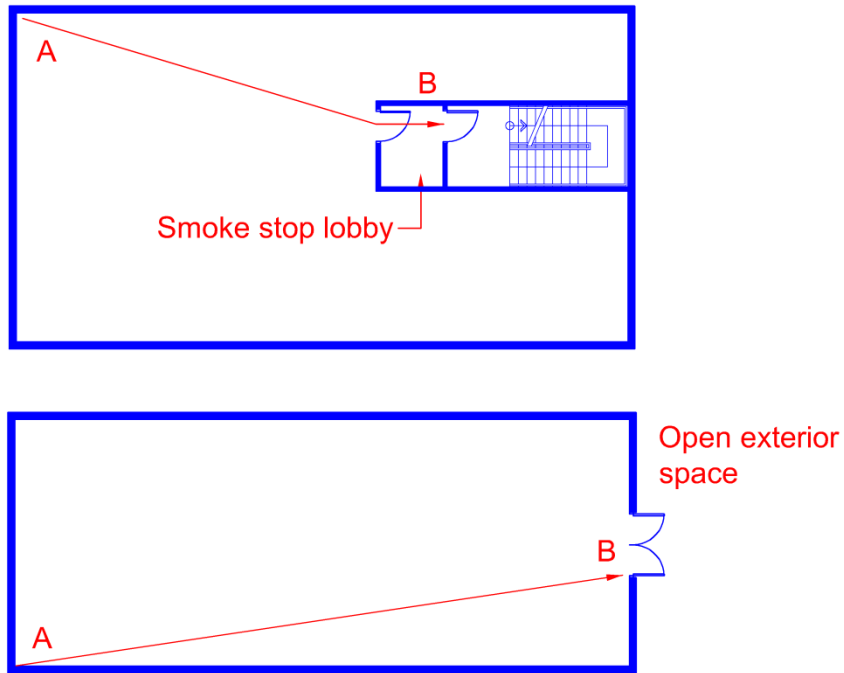

*Diagram 1.2.59 - 2*

c) *Travel distance from the most remote point to an external exit passageway (ie. from point A to B)*

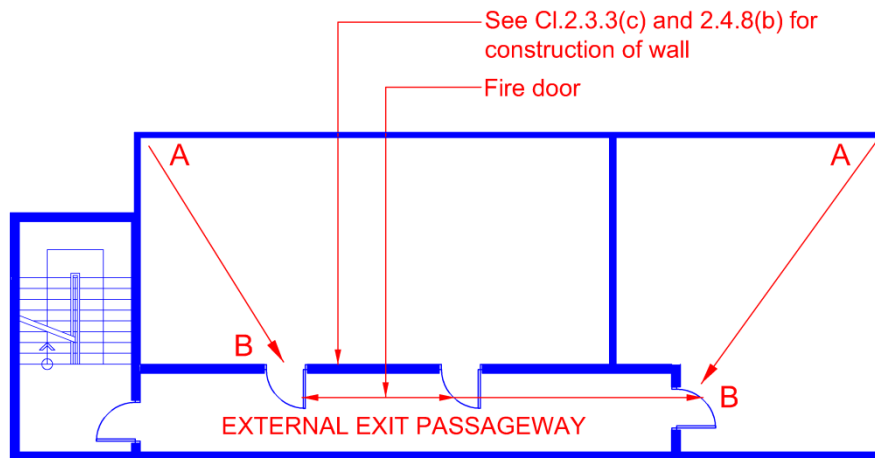

Section

*Diagram 1.2.59 - 3*

# CHAPTER 1

## 1.2 DEFINITIONS

### 1.2.60 Two-way escape (Remoteness of exits)

Where more than one exit is required from a building or portion thereof, such exits shall be remotely located from each other and shall be arranged and constructed to minimise the possibility that more than one can be rendered unusable by any one fire or other emergency condition.

### EXPLANATIONS & ILLUSTRATIONS

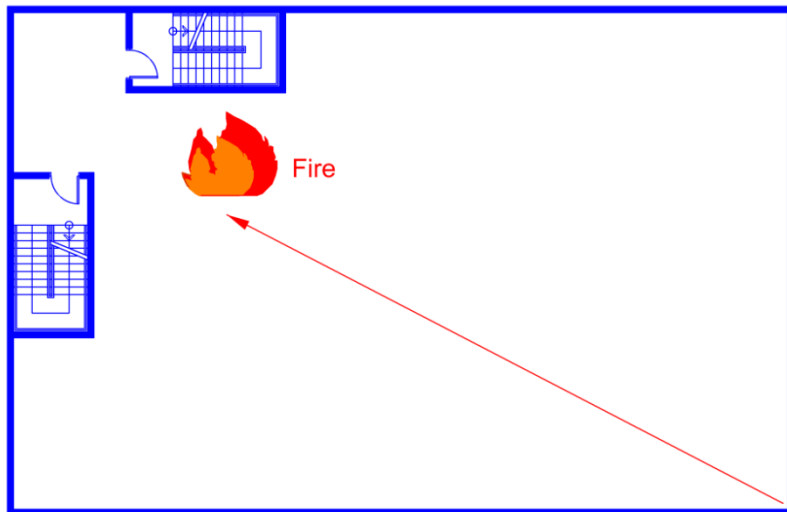

*Incorrect : Access to the protected staircases will be blocked by a fire occurring in the vicinity of the staircase.*

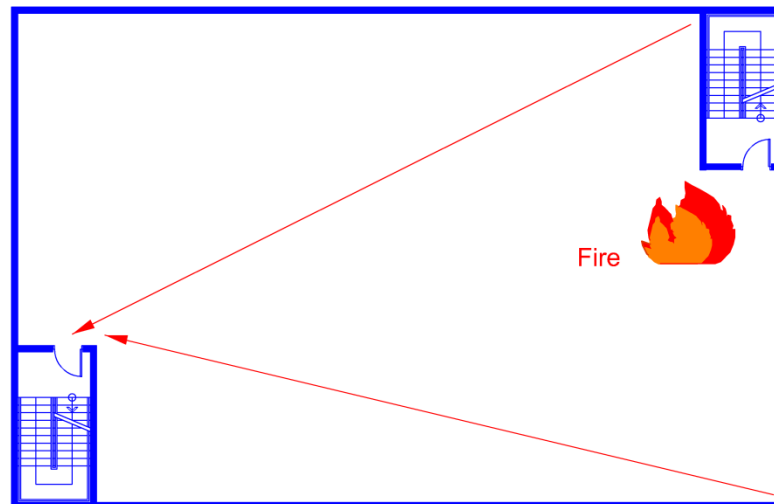

*Correct : Access to an alternate staircase is available if a fire occurred in the vicinity of the exit door to one of the staircases.*

*Diagram 1.2.60*

**(a) Two-way escape**

If two exits or exit access doors are required, they shall be placed at a distance from one another equal to or not less than half the length of the maximum overall diagonal dimension of the building or area to be served, measured in a straight line between the furthest edges of the exit doors or exit access doors (see diagram 1.2.60(a)(i) to (v)), subject to :

- i If the distance between the 2 exits or exit access doors is less than half the length of the maximum overall diagonal dimension of the building or area to be served, it shall be considered as a one-way escape arrangement; and
- ii The separation distance measured in a straight line between the furthest edges of the doors of the two exits (exit staircases, exit passageways or exit ramps) shall not be less than 7m.

**EXPLANATIONS & ILLUSTRATIONS**

**1.2.60**

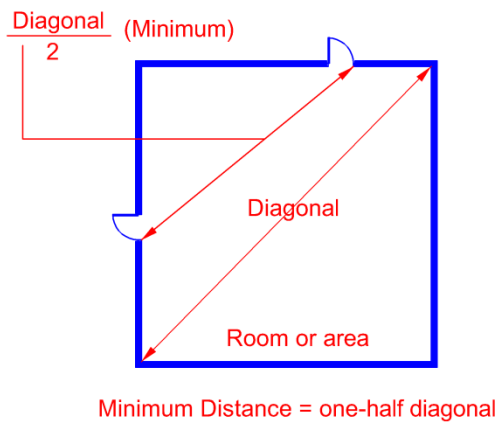

Diagram 1.2.60(a)(i)

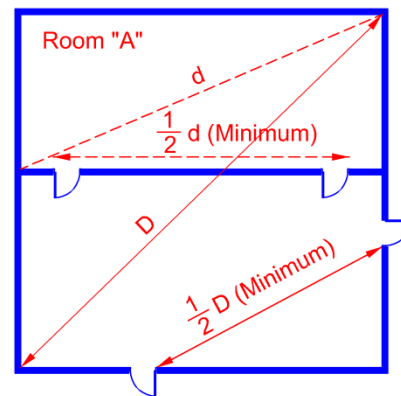

Diagram 1.2.60(a)(ii)

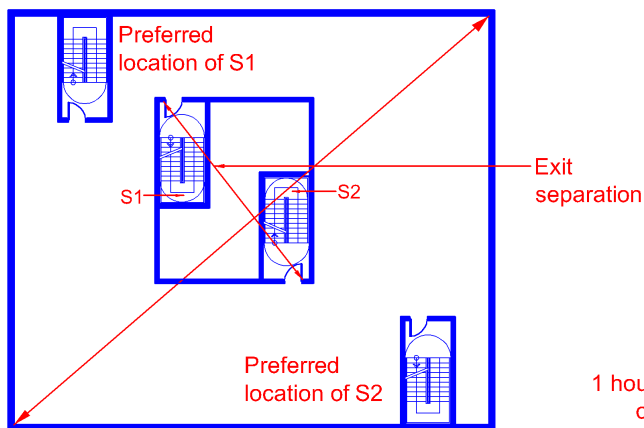

Diagram 1.2.60(a)(iii)

One-way escape arrangement

The distance between the exit of staircases S1 & S2 is less than half the length of the themax. overall diagonal dimension of the building or floor space

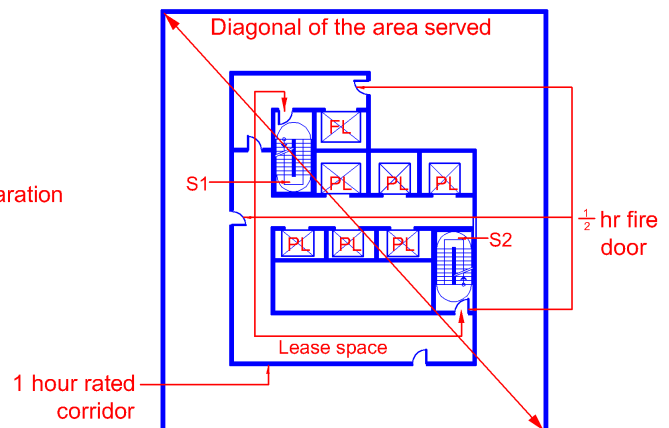

Diagram 1.2.60(a)(iv)

Two-way escape arrangement

Exit separation between the exit staircases S1 & S2 may be based on the travel distance in the exit access corridor enclosed with 1 hour fire rated walls and 1/2 hour fire rated door



Remoteness of exit staircase - Arrangement of exits

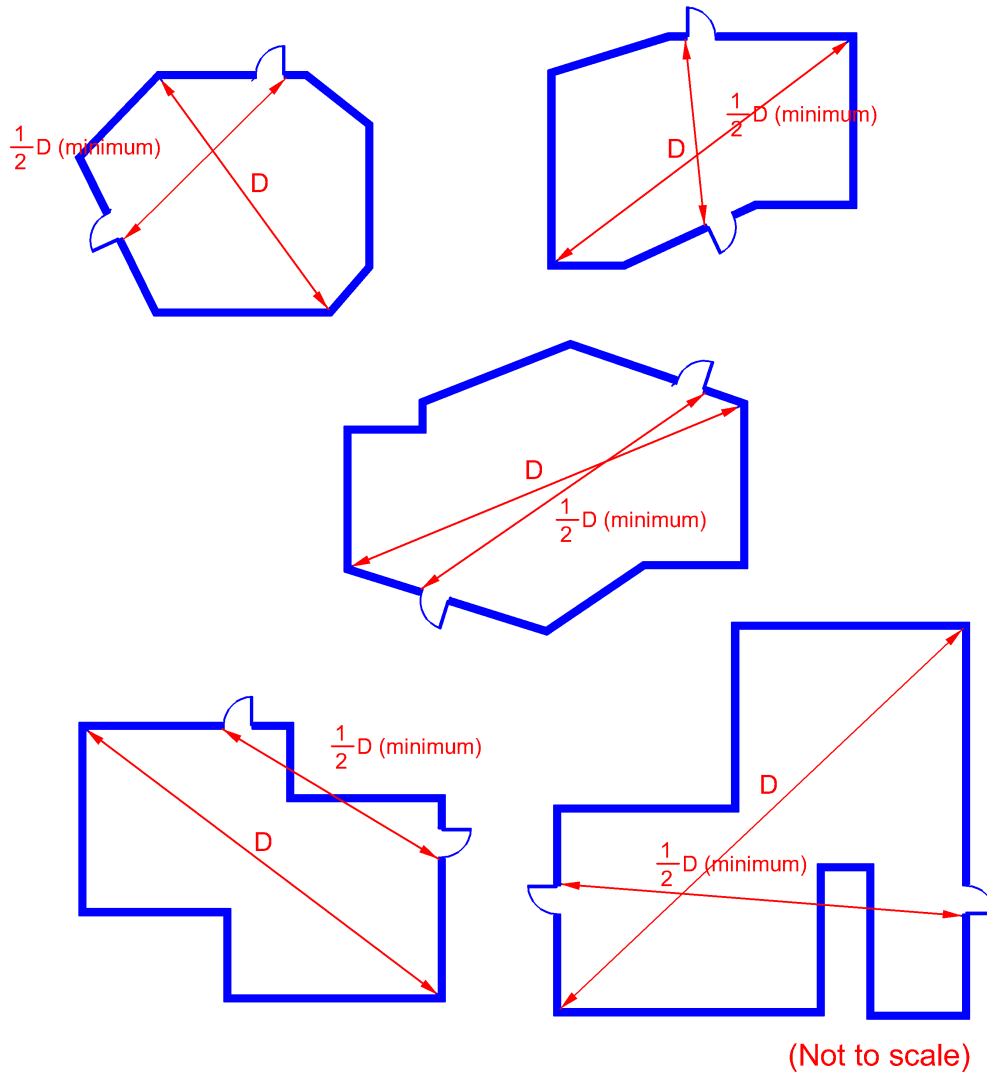

Diagram 1.2.60(a)(v)

**(b) Reduction in exit separation**

In buildings protected throughout by an approved automatic sprinkler system which complies with the requirements of chapter 6, the minimum separation distance between two exits or exit access doors measured in accordance with sub-clause 1.2.60(a) shall be not less than one third the length of the maximum overall diagonal dimension of the building or area to be served. The separation distance measured in a straight line between the furthest edges of the doors of the two exits (exit staircases, exit passageways or exit ramps) shall not be less than 7m.

**EXPLANATIONS & ILLUSTRATIONS**

**1.2.60**

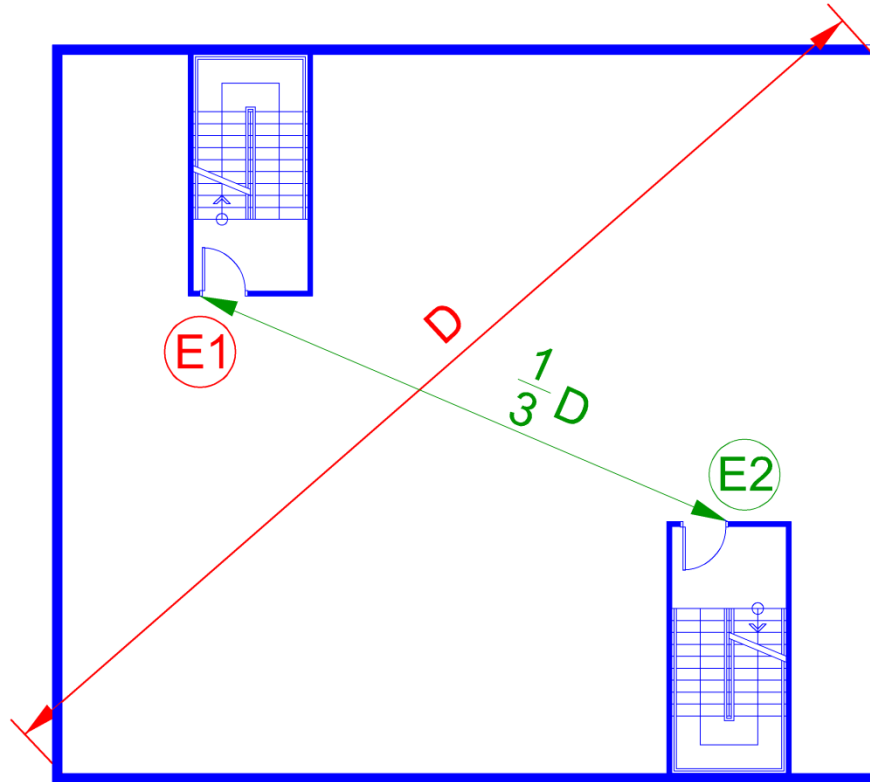

Sprinkler protected building

*Diagram 1.2.60(b)*

*The minimum separation distance (E1) and door (E2) shall not be less than 1/3 the maximum overall diagonal dimension of the building (D)*

**(c) Exit separation measured along exit access corridor**

Where two exit staircases, exit passageways or exit ramps are inter-connected by a corridor, exit separation shall be permitted to be measured along the line of travel within the exit access corridor. The exit access corridor connecting the exit staircases, exit passageways or exit ramps shall be protected by minimum one hour fire rated enclosures. Doors opening into this corridor shall have minimum half hour fire resistance rating (see diagram 1.2.60(c)). The separation distance measured along the line of travel within the exit access corridor between the furthest edges of the doors of the two exits (exit staircases, exit passageways or exit ramps) shall not be less than 7m.

**EXPLANATIONS & ILLUSTRATIONS**

**1.2.60**

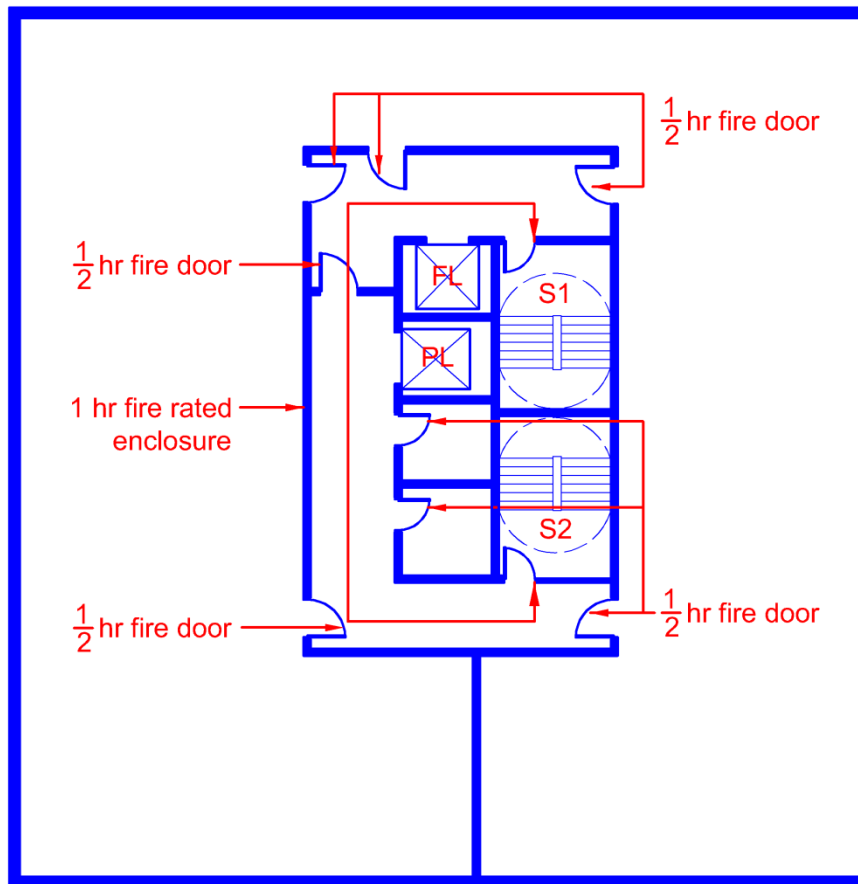

Remoteness of exit staircases - Arrangement of exit staircases

*Diagram 1.2.60(c)-1*

*Remoteness of exits is measured along 1-hour rated corridor with 1/2 hour fire doors. In place of measuring physical distance between exit stair enclosures, distance for purposes of determining remoteness is permitted to be measured along a protected corridor, provided the separation distance between the furthest edges of the doors of the two exits is not less than 7m*

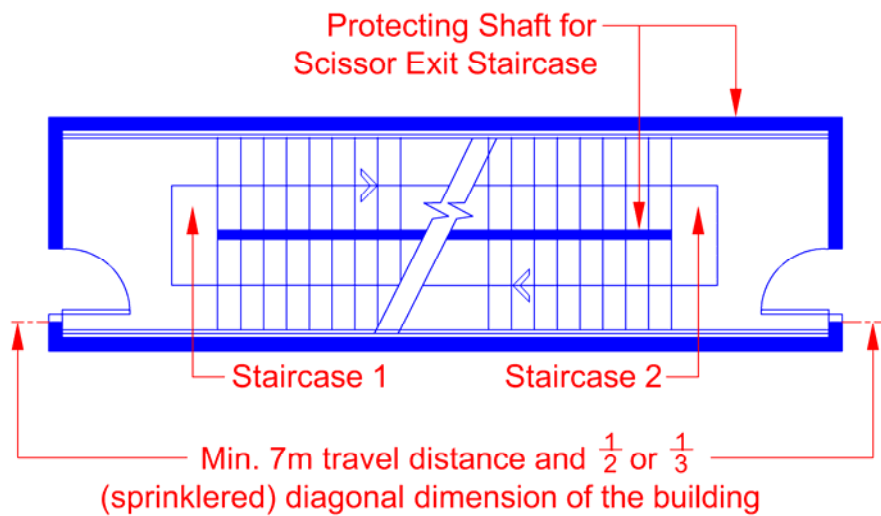

Diagram 1.2.60(c)-2

When there is only one pair of scissor exit staircase, the door opening into scissor exit staircases shall be spaced at least  $\frac{1}{3}$  the diagonal dimension of the area to be served in a sprinklered protected building and  $\frac{1}{2}$  the diagonal dimension in a non-sprinkler protected building in accordance with Cl. 1.2.60.

Door opening into scissor exit staircase shall be at least 7m measured as travel distance between the two closer edges of the staircase doors. The line of measurement for scissor exit staircase is measured to the nearest edge instead of furthest edge of the exit doors.

**(d) One-way travel**

- i A one-way travel or “common path” exists if a floor space is arranged or provided with partitioning works such that occupants within that space are able to travel in only one direction to reach any of the exits or to reach the splitting point where they have the choice of two or more routes of travel to remote exits.
- ii The travel distance from the most remote point to the splitting point shall not exceed the permissible one-way travel distance allowed in Table 2.2A. At the splitting point, the angle of divergence between any two alternative routes shall not be less than 90 degrees in order that the routes originating from the splitting point can be considered as two-way travel.
- iii The aggregate travel distances of the one-way travel from the most remote point to the splitting point and the continuous two-way travel from the splitting point to the nearest exit shall not exceed the permissible two-way travel distance allowed in Table 2.2A.

**EXPLANATIONS & ILLUSTRATIONS**

**1.2.60**

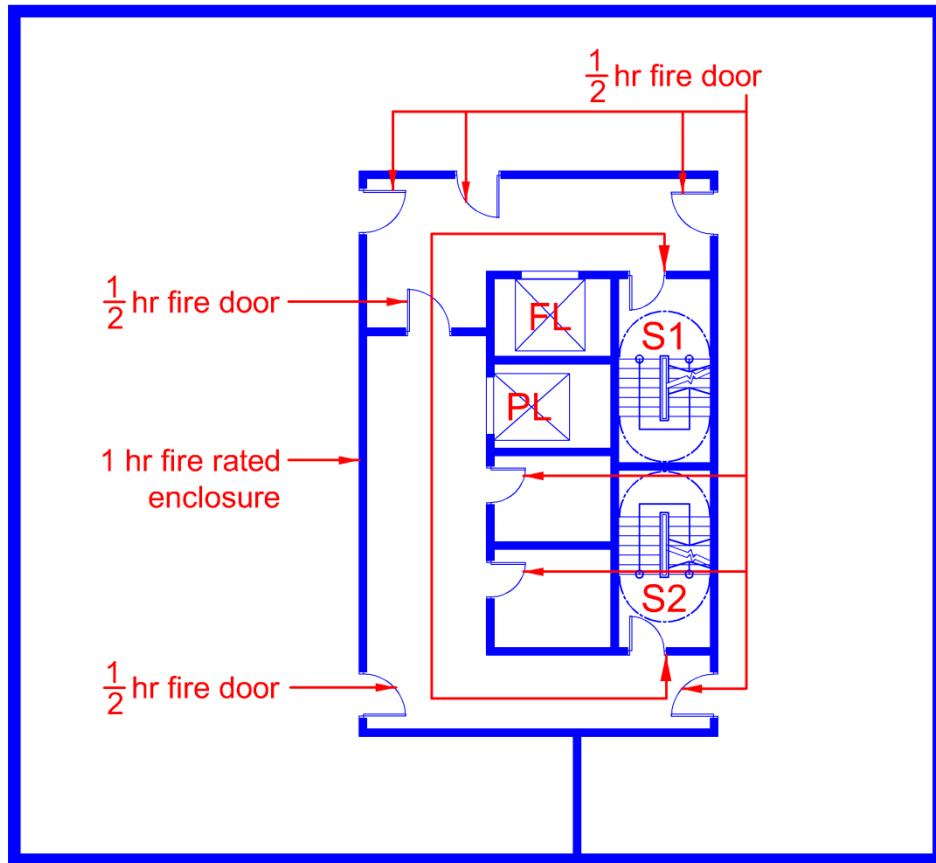

*Diagram 1.2.60(d)*

*Remoteness of exits is measured along 1-hour rated corridor with 1/2 hour fire doors. In place of measuring physical distance between exit stair enclosure, distance for purposes of determining remoteness is permitted to be measured along a protected corridor.*

# CHAPTER 1

## 1.2 DEFINITIONS

### 1.2.61 Unprotected area

In relation to a side or external wall of a building means:

- A window, door or other opening, and
- Any part of the external wall which has less than the relevant fire resistance required in Cl.3.5, and
- Any part of the external wall which has combustible material more than 1 mm thick attached or applied to its external face whether for cladding or any other purpose.

### EXPLANATIONS & ILLUSTRATIONS

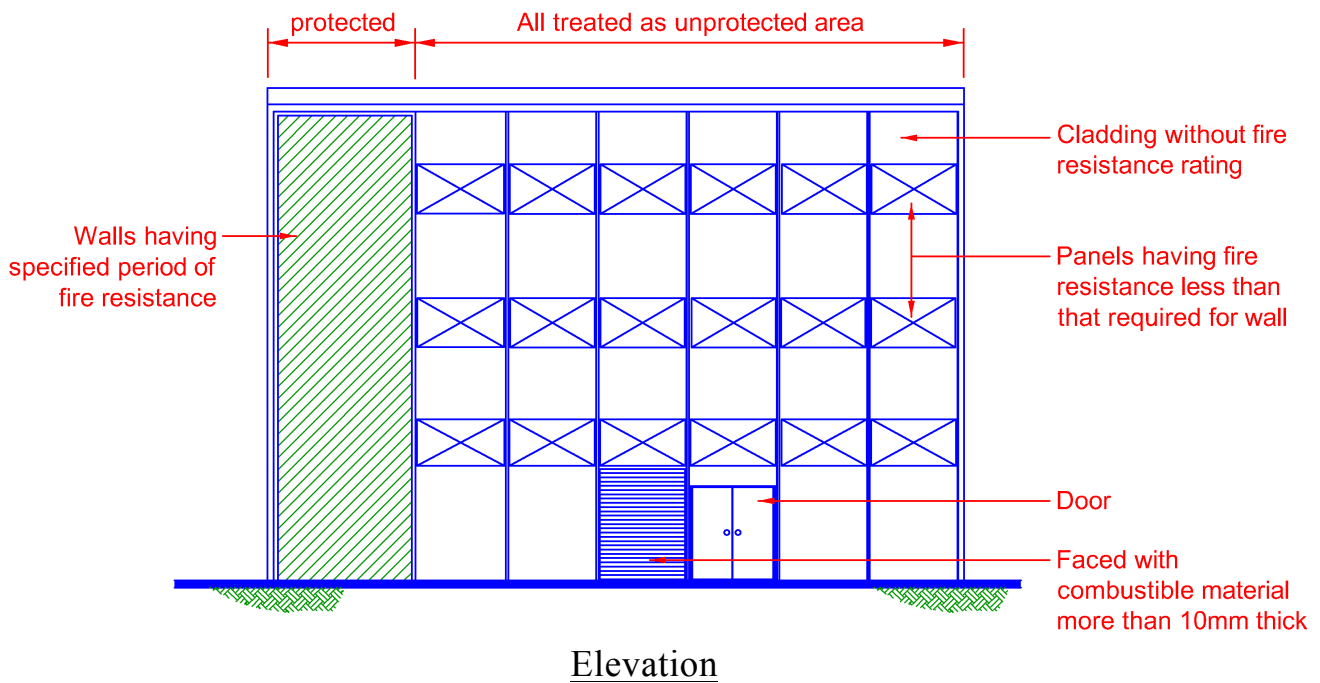

Diagram 1.2.61

# CHAPTER 1

## 1.2 DEFINITIONS

### 1.2.62 Vertical exit

An exit staircase or exit ramp serving as required exit from one or more storeys above or below ground level.

### EXPLANATIONS & ILLUSTRATIONS

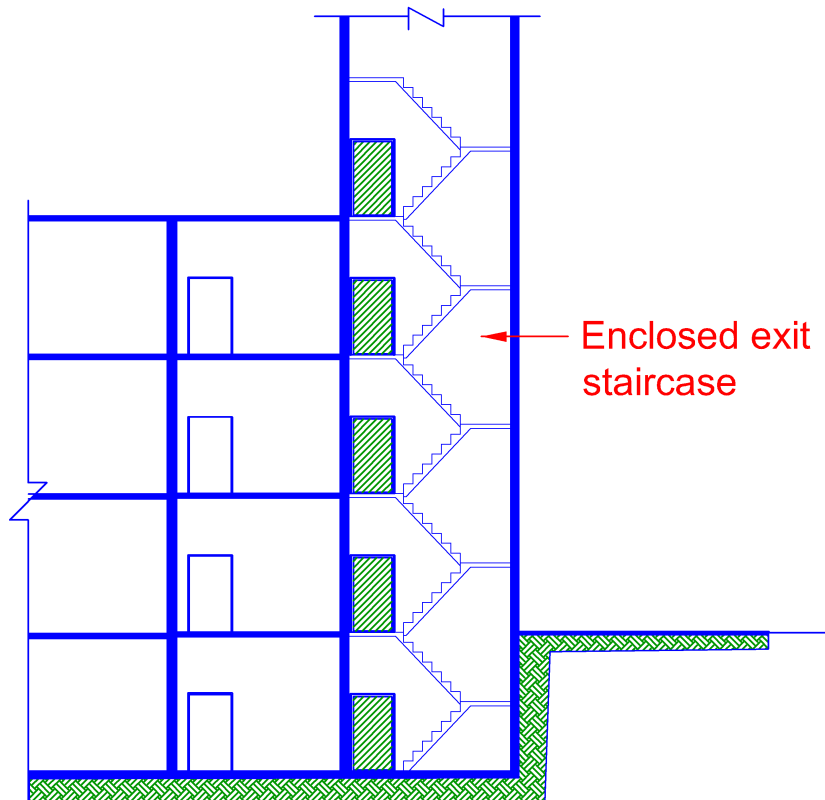

Section

*Diagram 1.2.62*

*The protecting structure, excluding external wall of exit staircase or exit ramp shall be constructed of masonry.*

# CHAPTER 1

## 1.2 DEFINITIONS

### 1.2.63 Wall surface

For the purpose of internal surfaces, includes:

- a) The surface of glazing, and
- b) Any part of ceiling which slopes at an angle of 70 degrees or more to the horizontal,

but excluding:

- i) door frames and unglazed parts of doors, and
- ii) window frames and frames in which glazing is fitted, and
- iii) architraves, cover moulds, picture rails, skirtings and similar narrow members, and
- iv) fitted furniture

### EXPLANATIONS & ILLUSTRATIONS

*Includes:*

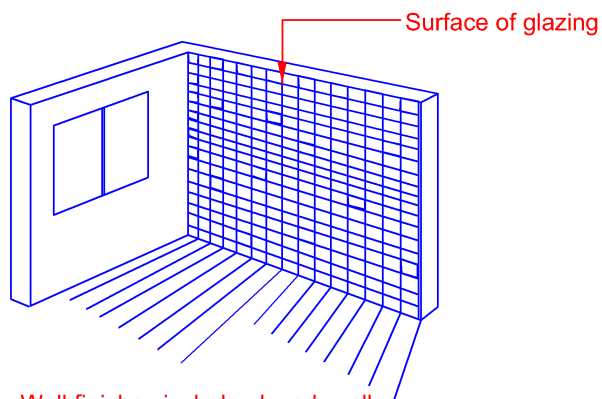

Wall finishes include glazed, wall paper more than 0.8m thickness

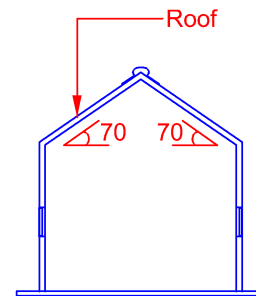

Ceiling slopes at 70 degree or more to the horizontal

*Excludes:*

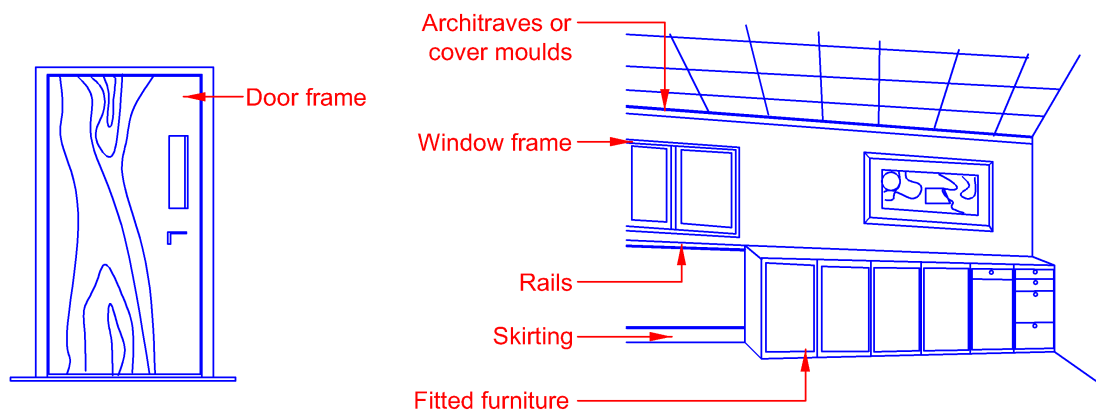

Diagram 1.2.63