

# CHAPTER 3

## 3.1 GENERAL

### 3.1.1

The purpose of this chapter of the Code is to stipulate requirements to minimise the risk of spread of fire between adjoining buildings by separation, prevent the untimely collapse of buildings in the event of fire by the provision of a stable and durable form of construction and prevent the spread of fire between specified parts of the buildings by the division of such buildings into compartments.

### EXPLANATIONS & ILLUSTRATIONS

*Structural fire precautions relate to the integrity and stability of building elements during fire for a required period of time. "Structural" does not only apply to the structural elements of buildings but other building components, e.g. doors, shafts, walls/ceiling finishes.*

*The objectives of structural fire precautions are :*

- (a) To unload the spread of fire between adjoining buildings by adequate separation;*
- (b) To prevent the untimely collapse of building, including walls and floors of each unit in the event of a fire;*
- (c) To prevent spread of fire from one unit to another within the building envelope by compartmentalising each unit with walls, floors and doors having the requisite fire resistance rating.*

# CHAPTER 3

## 3.2 PROVISION OF COMPARTMENT WALLS AND COMPARTMENT FLOORS

### 3.2.1 Compartment size - floor area & cubicle extent

Any building other than a building of Purpose Group I which has –

- (a) Any storey the floor area of which exceeds that specified as relevant to a building of that height in column (2) of Table 3.2A, or
- (b) A cubic capacity which exceeds that specified as relevant in column (3) of Table 3.2A, shall be divided into compartments by means of compartment walls and compartment floors so that –
  - (i) no such compartment has any storey the floor area of which exceeds the area specified as relevant to the building in column (2) of the Table, and
  - (ii) no such compartment has a cubic capacity which exceeds that specified as relevant in column (3) of the Table.

### EXPLANATIONS & ILLUSTRATIONS

*Generally, the compartment size of apartment or maisonette unit would not exceed 4000m<sup>2</sup> or a cubical extent of 15000m<sup>3</sup> as given in Table 3.2A which is reproduced below:*

TABLE 3.2A SIZE LIMITATION OF BUILDING AND COMPARTMENT

(1) Compartments	(2) Maximum Floor Area	(3) Maximum Cubical Extent
Compartment below ground level. No compartment to comprise more than one storey.	2000m <sup>2</sup>	7500m <sup>3</sup>
Compartments between average ground level and a height of 24m. No compartment to comprise more than 3 storeys.	4000m <sup>2</sup>	15000m <sup>3</sup>
Compartments above a height of 24m from average ground level. No compartment to comprise more than one storey.	2000m <sup>2</sup>	7500m <sup>3</sup>

*However, for non-residential areas in buildings under Purpose Group II, such as communal area or car parking area irrespective of location in either upper storeys or basement, there would be a need to apply the size limitation of 4000m<sup>2</sup> or 15000m<sup>3</sup>. The above non-residential areas would be dealt with under their respective Purpose Groups VII & VIII respectively.*

Compartment below ground level

(i) Under Table 3.2A no compartment shall comprise more than one storey and exceed floor area of 2000m<sup>2</sup> and a cubical extent of 7500m<sup>3</sup>. However, exceptions are allowed in the following situations:

(a) Only 1<sup>st</sup> basement having a floor area of less than 100m<sup>2</sup> can form part of the 1<sup>st</sup> and upper storey compartment under Cl.3.2.5(a), provided the building is sprinklered protected including the basement.

(b) Basement floors can be interconnected for use as car parking, if sprinkler system is provided.

(ii) Basement floor or compartment shall not be used for bulk storage of highly inflammable liquids or substances of any explosive nature.

Compartments between average ground level and a height of 24m

(i) No compartment shall comprise more than 3 storeys and floor area greater than 4000m<sup>2</sup> and cubical extent exceeding 15000m<sup>3</sup>. However, exceptions are allowed under clauses 3.2.3, 3.2.4(a) and 3.2.8.

Compartments above a height of 24m from averaged ground level

(i) No compartment shall comprise more than 3 storeys and floor area greater than 4000m<sup>2</sup> and cubical extent exceeding 15000m<sup>3</sup>. Every storey above a height of 24m shall be a fire compartment.

*General: In computing the extent of a compartment, protected shafts e.g. lift, staircases etc and separately compartmented lavatory/locker room may be disregarded. See cl.1.2.16 for further illustration.*

(ii) High bay warehouse (HBW) and mechanised car parking buildings are treated differently from normal industrial buildings.

*The requirement of restricting the compartment to max. 3 storeys would not be applicable. Such types of buildings are usually not occupied or have very limited people working in the premises.*

*Automatic sprinkler system and smoke extraction or venting system are required to be provided for high bay warehouses and mechanised car parking buildings which exceed 24m in building height.*

Compartments above a height of 24m from averaged ground level

(i) No compartment shall comprise more than one storey and exceed the floor area of 2000m<sup>2</sup> and cubical extent of 7500m<sup>3</sup>.

*This requirement would not apply to high bay warehouses and mechanised car parking buildings. Prior consent is to be obtained from SCDF (FSSD) before submission of building plan.*

# CHAPTER 3

## 3.2 PROVISION OF COMPARTMENT WALLS AND COMPARTMENT FLOORS

### **3.2.2 Cubical extent for compartment exceeding 4m in height**

(a) In computing the cubical extent of compartments in single storey buildings such as factories, sport halls, markets, foodcourts, multi-purposes halls, cinemas, concert halls, churches, temples and similar buildings, the height of 4 metres shall be used where the actual height exceeds that figure.

If any compartment comprises more than one storey or contains mezzanine, galleries or lofts, the full height of the compartment shall be used in computing the cubical extent for each storey, mezzanine, galleries or lofts.

(b) Where two buildings are connected by external open-sided covered way or covered link-bridge, the buildings are considered as separate buildings, if the following conditions are complied with:

(i) Within the covered way or link-bridge there is no commercial activities or other usage that would pose a fire risk:

(ii) The width of the covered way or covered link-bridge shall not exceed 5m measured from eave to eave.

### **EXPLANATIONS & ILLUSTRATIONS**

*For illustrations see clause 1.2.16 of Chapter 1.*

# CHAPTER 3

## 3.2 PROVISION OF COMPARTMENT WALLS AND COMPARTMENT FLOORS

### 3.2.3 Exception to Cl. 3.2.1

Cl.3.2.1 is not applicable if the building:

- (a) is fitted throughout with an automatic sprinkler system which complies with the requirements in Chapter 6, and
- (b) complies with Cl.3.2.4, Cl.3.2.6, Cl.7.5 and Appendix (4).

### EXPLANATIONS & ILLUSTRATIONS

### 3.2.3

*To avoid providing fire compartmentation in building to comply with the cubical extent and floor area control under Table 3,2A, automatic sprinkler system would be proposed as an alternative. Where automatic sprinkler system is to be provided to a building, compliance with Table 3.2A on max 3 storeys per compartment is still required, unless atrium design is proposed subject to obtaining SCDF (FSSD)'s prior approval before submission of building plan.*

*QPs should consult SCDF(FSSD) for all atrium designs. Requirements provided under clause 7.5, clause 3.2.6, clause 3.2.4 and Appendix (4) are to be complied with respectively.*

# CHAPTER 3

## 3.2 PROVISION OF COMPARTMENT WALLS AND COMPARTMENT FLOORS

### 3.2.4 Compartmentation by height

(a) In any compartment except those mentioned under sub-clause 3.2.4(d), up to a habitable height of 24m, no compartment shall comprise more than three storeys. This requirement can be relaxed for Atrium spaces provided the design of such spaces complies with the conditions stipulated under Cl. 3.4.6.

### EXPLANATIONS & ILLUSTRATIONS

3.2.4

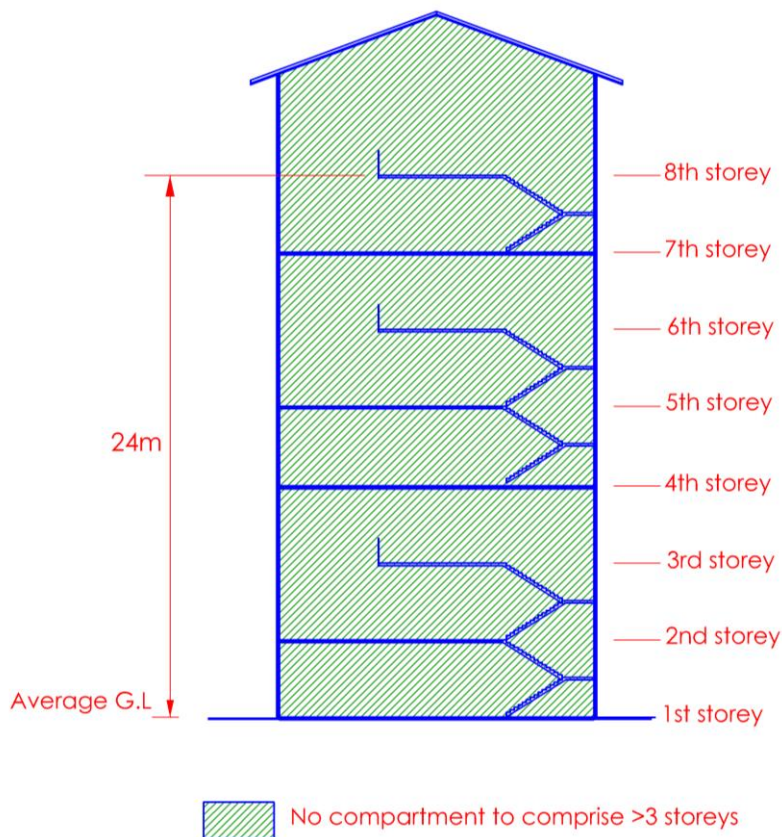

Diagram 3.2.4(a)

Where 3 storeys or levels form one compartment, the total floor area shall not exceed 4000m<sup>2</sup> and the total cubical extent shall not exceed 15000m<sup>3</sup>, subject to compliance with travel distance requirements under Chapter 2.

In the case of atrium design space, it can go beyond 3 storeys per compartment but shall not exceed habitable height of 24m. In other words, every storey beyond 24m in height is a fire compartment.

(b) In any building which exceeds 24m in habitable height, no compartment shall comprise more than one storey for compartments at storey level exceeding 24m above average ground level, other than a compartment which is within a residential maisonette which may comprise two storey levels.

**EXPLANATIONS & ILLUSTRATIONS**

**3.2.4**

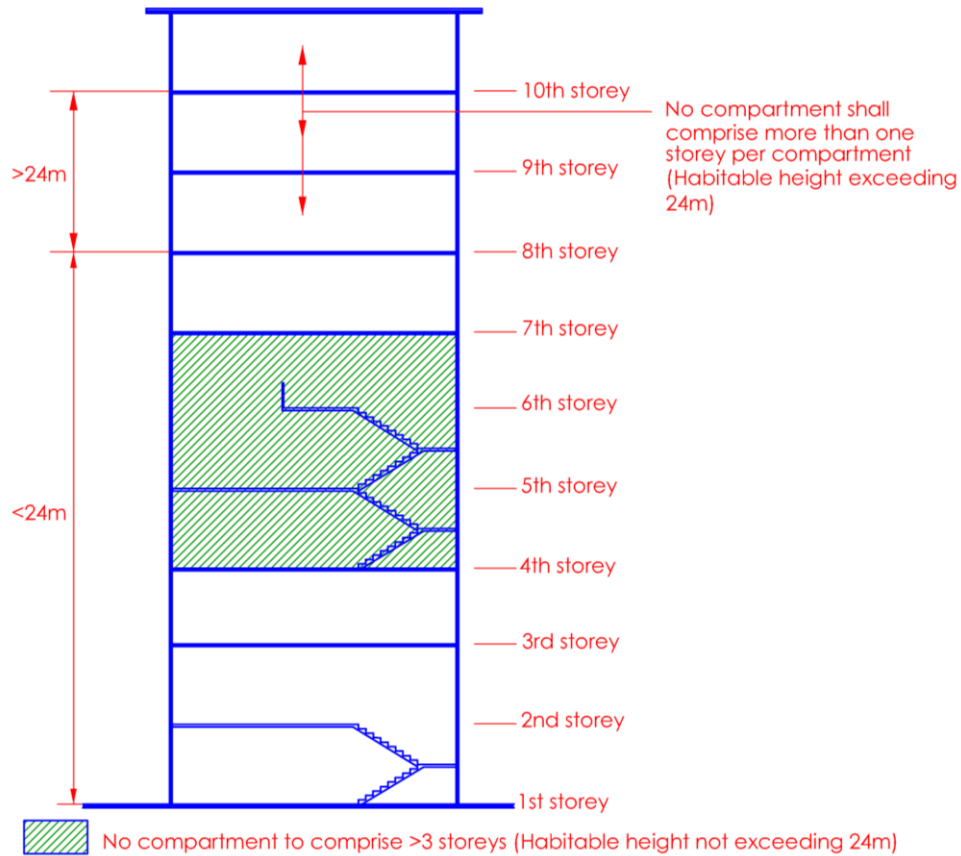

Diagram 3.2.4(b)-1

*In any commercial building which exceeds 24m in habitable height, no compartment shall comprise more than one storey per compartment from storey level exceeding 24m above average ground level. There is a need to keep the fire compartment size small within 2000m<sup>2</sup> or 7500m<sup>3</sup> above that habitable height, as it would otherwise pose difficulties to fire fighting and control of fire spread should there be a fire occurrence in one of those high-rise units.*

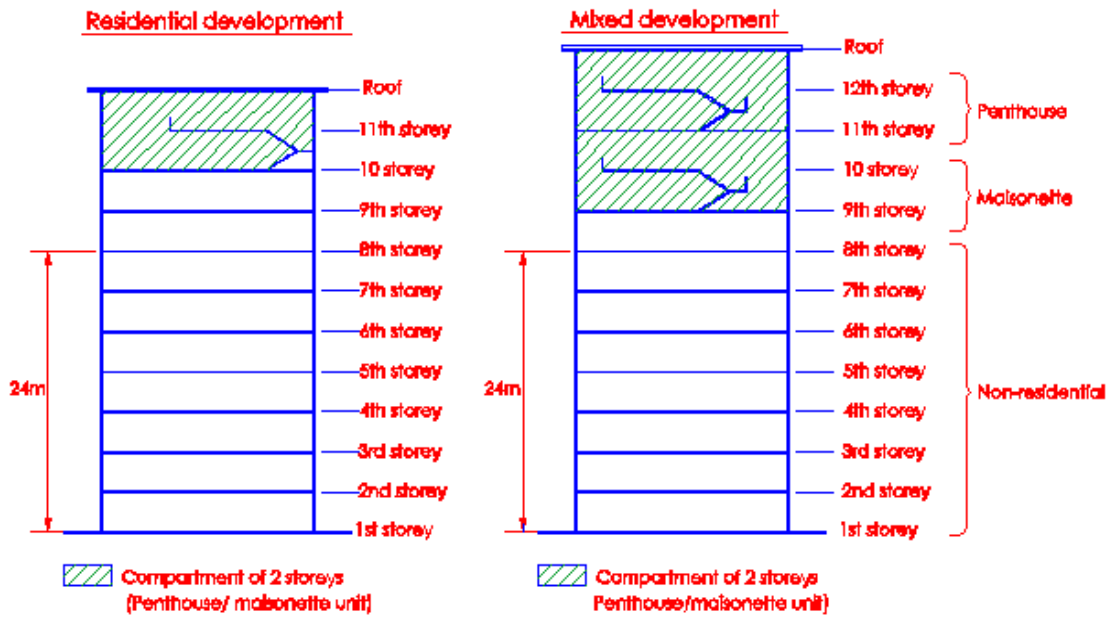

Diagram 3.2.4(b)-2

*In any residential building which exceeds 24m in habitable height, no compartment shall comprise more than one storey per compartment from storey level exceeding 24m above average ground level. However, for residential maisonette or penthouse unit, maximum two storey levels are allowed to form one compartment. This should be taken as a relaxation. There is a need to keep the fire compartment size small within 2000m<sup>2</sup> or 7500m<sup>3</sup> above that habitable height as it would otherwise pose difficulties to fire fighting and control of fire spread should there be a fire occurrence in one of those high-rise units. In situation where there are maisonette or penthouse units located in non-residential building, fire protection/detection system applicable to the building shall be extended to cover the residential units.*



(c) Single household dwelling

Buildings under Purpose Group I may consist of more than 3 floors if they are occupied as a single household dwelling.

**EXPLANATIONS & ILLUSTRATIONS**

**3.2.4**

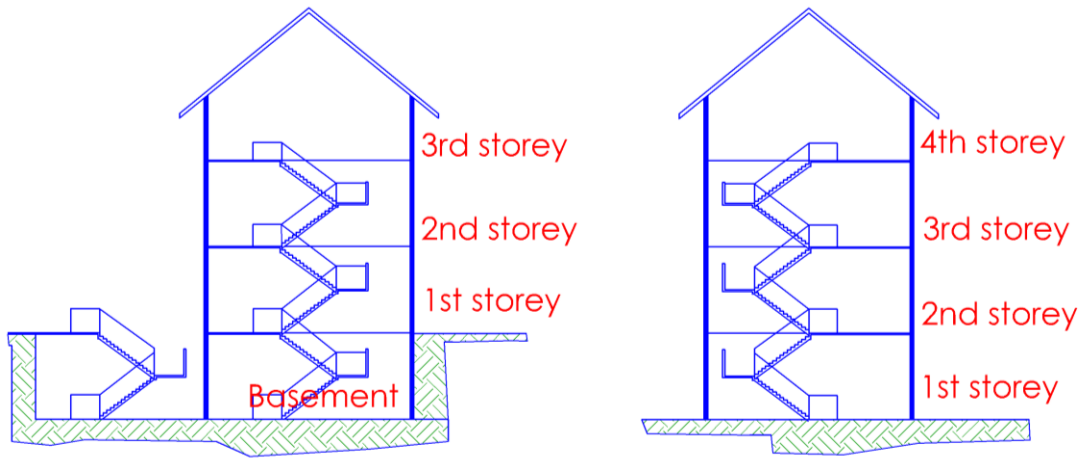

4 storeys or levels form one compartment

Diagram 3.2.4(c)

*Building having 4 stories or levels under Purpose Group I are permitted. The above relaxation was introduced in 13 June 1996 to take into consideration of proliferation of 4-level purpose group I buildings due to the sudden surge in the public demand for two storey conventional houses with and attic and basement.*

*FSSD reviewed the above matter and issued a circular on 14 Dec 1999 to allow buildings under Purpose Group I to have more than 3 levels or floors if they are occupied as a single household dwelling without the need to provide automatic fire system or external staircase.*

# CHAPTER 3

## 3.2 PROVISION OF COMPARTMENT WALLS AND COMPARTMENT FLOORS

### 3.2.5 Other cases requiring compartment walls & compartment floors

The following situations shall require compartmentation by provision of compartment walls and/or compartment floors –

(a) Purpose Group II

Any wall and floor separating a residential apartment or maisonette from any other part of the same building, unless permitted (as in the case of an external wall adjoining an external corridor, for provision of window openings).

### EXPLANATIONS & ILLUSTRATIONS

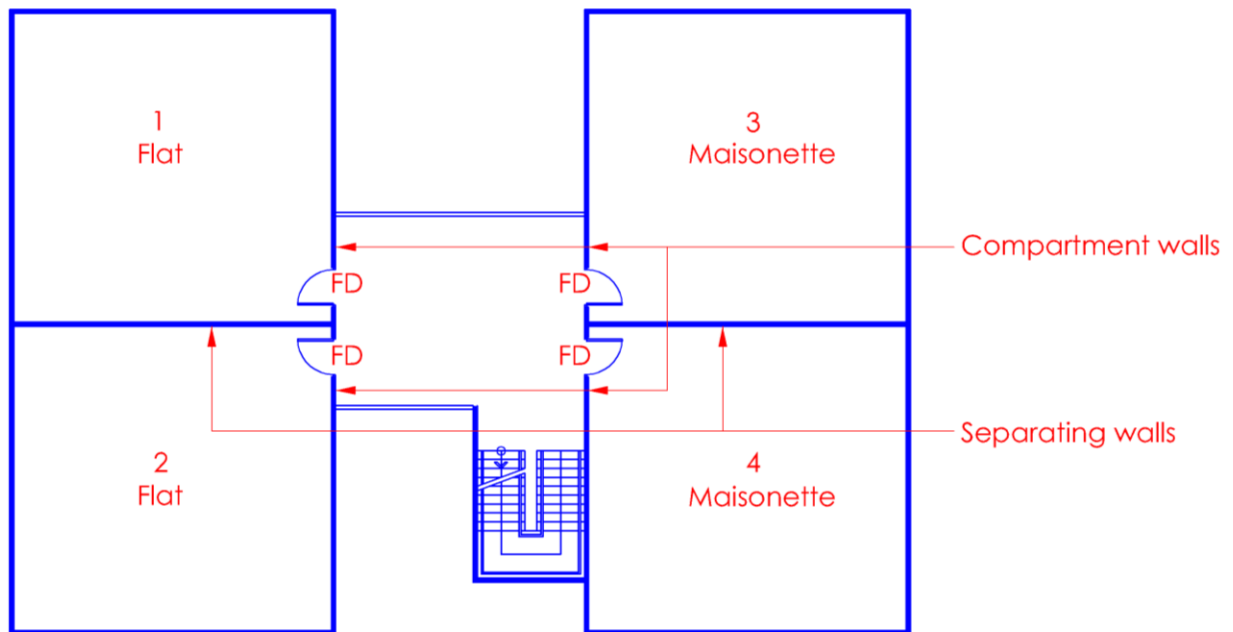

FD = Fire door

Plan

Diagram 3.2.5(a) – 1

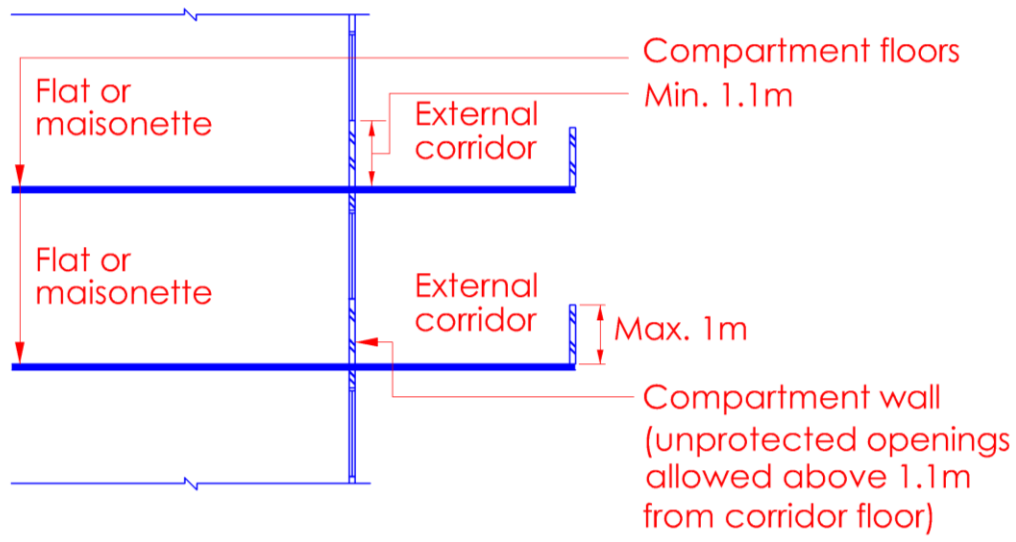

Section

Diagram 3.2.5(a) – 2

(b) Separation of purpose groups

Any wall and floor separating part of a building from any other part of the same building which is used or intended to be used mainly for a purpose falling within a different purpose group, as identified under Table 1.2B, except the following:

- (i) Ancillary offices located within a building or compartment of Purpose Group III, V, VI, VII and VIII
- (ii) Rooms or spaces for ancillary usage located within a building or compartment of Purpose Group III, IV, V, VI, VII and VIII as stipulated under Cl.1.2.2(B).
- (iii) Rooms or spaces located within a sprinkler protected building, unless otherwise stated in following sub-clauses of 3.2.5 or other clauses in the Code.

**EXPLANATIONS & ILLUSTRATIONS**

**3.2.5**

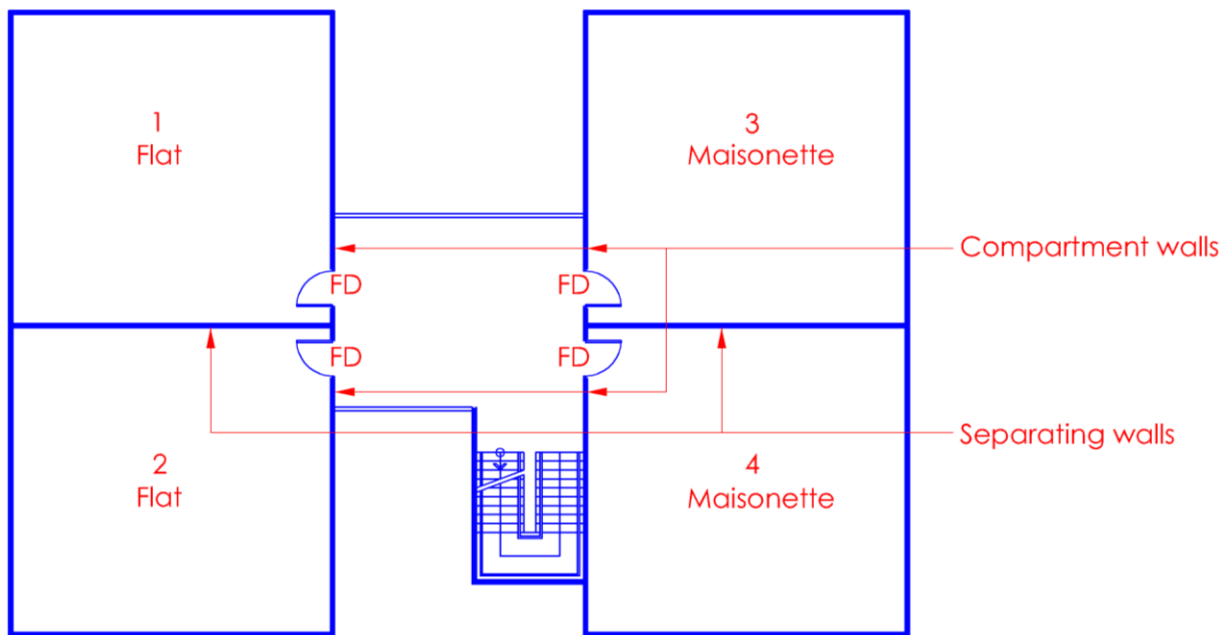

FD = Fire door

Plan

*Diagram 3.2.5(b)-1*

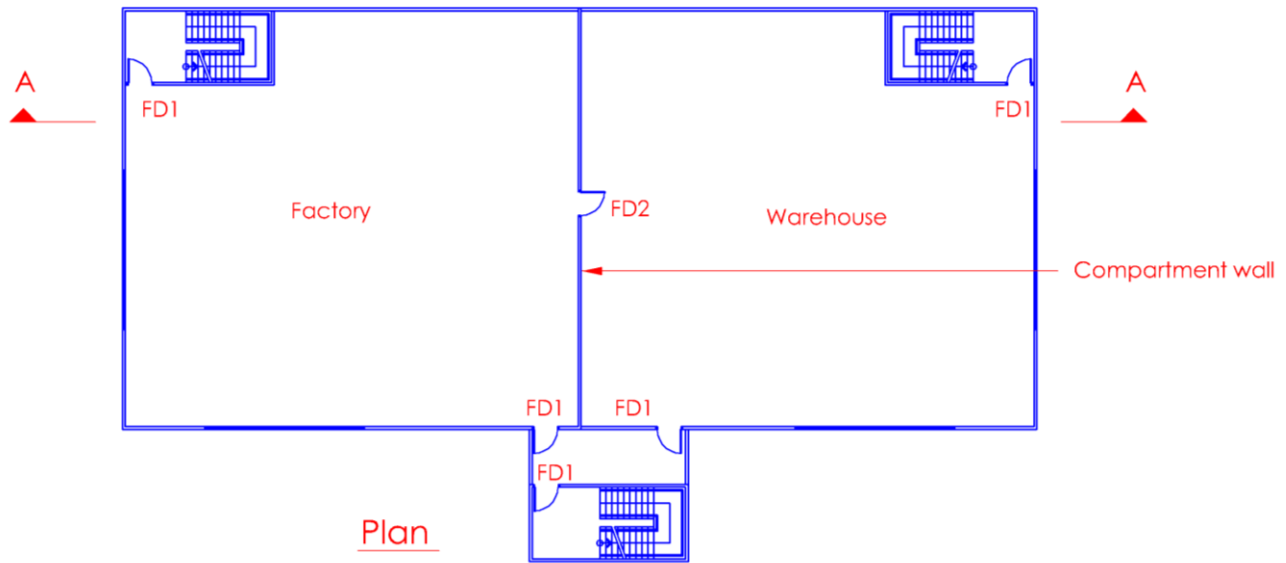

FD1 : Fire door min. half hour fire resistance rating  
 FD2 : Fire door having the same fire resistance rating as the compartment wall

*Diagram 3.2.5(b)-2*

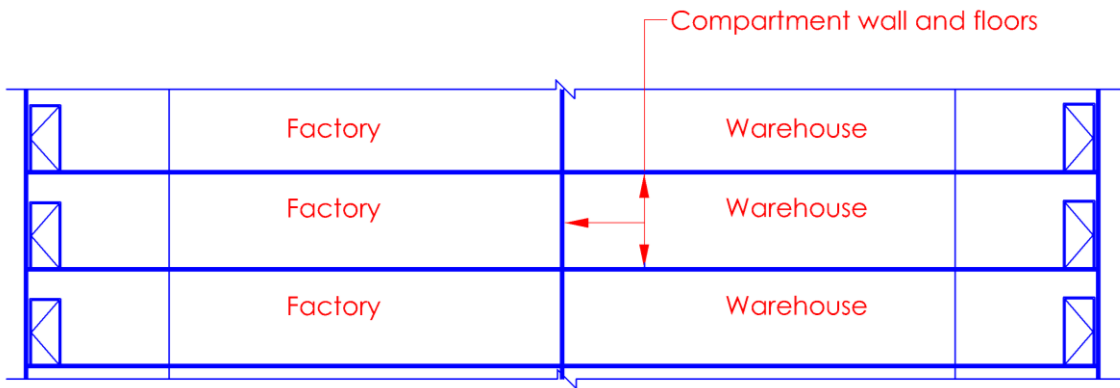

Section A - A

*Diagram 3.2.5(b)-3*

*Compartment walls and floors shall be constructed of non-combustible materials to have minimum 1 hour fire resistance rating under Table 3.3A for any of the compartment.*

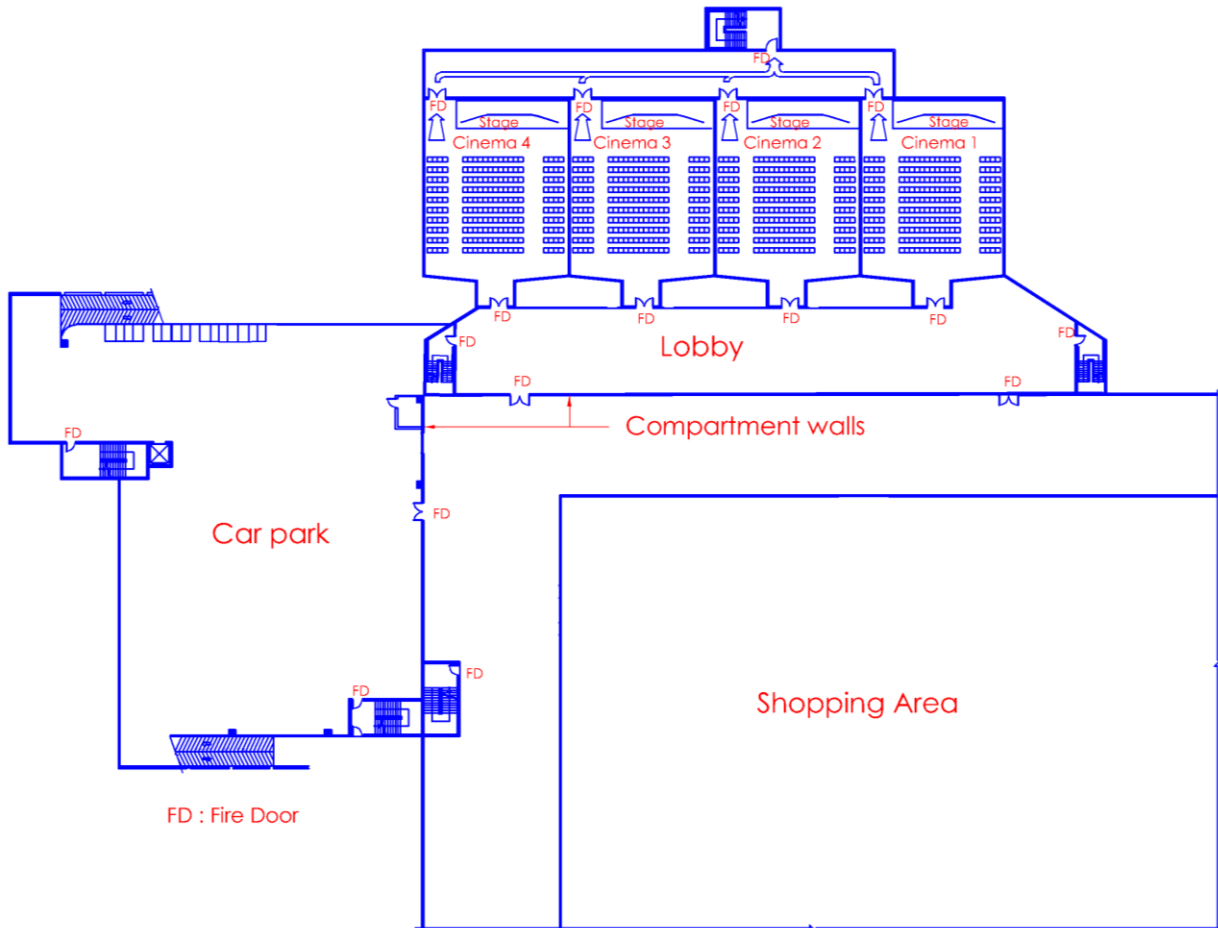

Diagram 3.2.5(b)-4

*In the above diagram, the car park (Purpose Group VIII) is fire compartmented from the shopping area. The car park has higher fire risks than shopping and cineplex. Fire separation between cineplex and shopping area is required. This is to safeguard the occupants in the cineplex from any fire occurrence in the shopping area.*

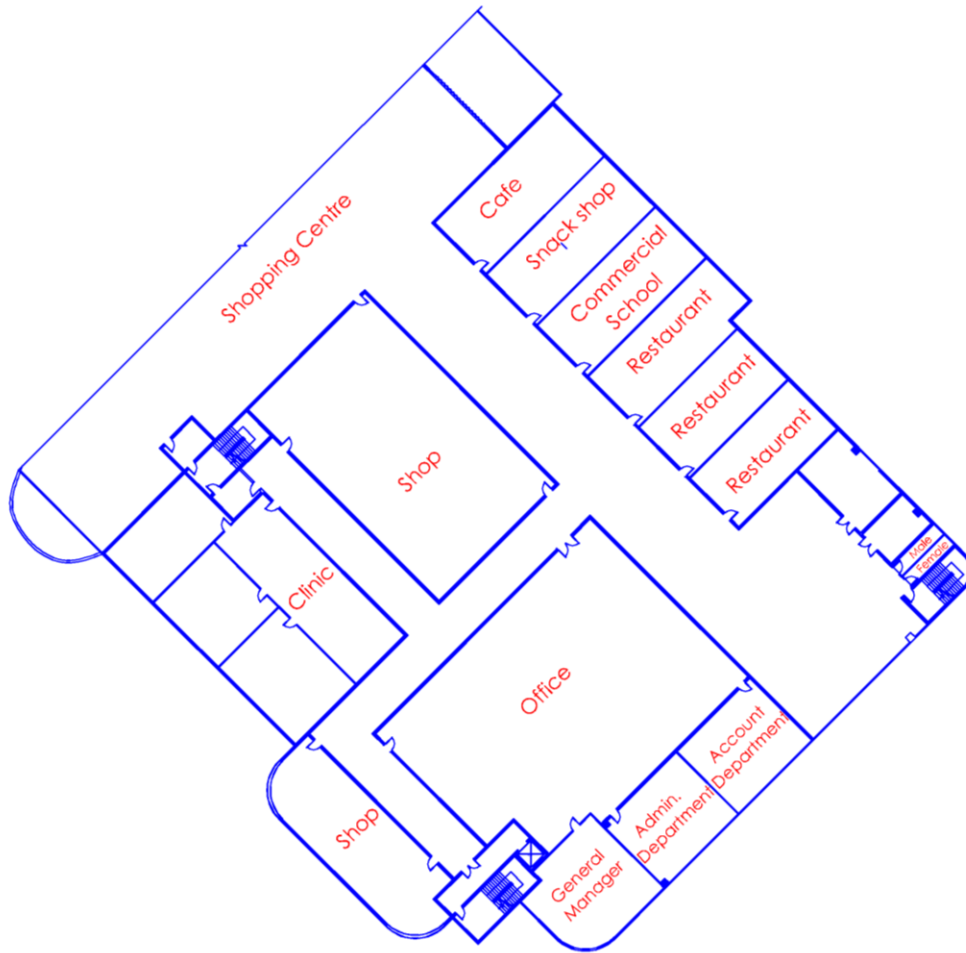

Diagram 3.2.5(b)-4

The above diagram shows a typical shopping floor, which has a mixture of different purpose groups without fire compartmentation.

Strictly interpreting the above subclause would mean that in a shopping centre, for example, shop (Purpose Group V), office (Purpose Group IV), place of public resort (Purpose Group VII), commercial school (purpose Group III) would need to be separately compartmented from each other. This would not be practical. In practice, shopping or commercial buildings would have mixture of the uses of different purpose groups.

Under sub-clause (b)(i), an ancillary office which is located within the compartment or floor used as Purpose Group V is not required to be separately fire compartmented, provided the measurement of travel distance requirements of Purpose Group III shall apply to the ancillary office. Similarly, under sub-clause (b)(ii), ancillary usage to Purpose Group III such as sick/first aid room, reception lobby/area, waiting area, staff lounge/staff recreation room, staff rest room/pantry, staff changing/locker room, meeting room, staff training room, etc. is not required to be separately fire compartmented.

(c) Floor over a basement

Any floor immediately over a basement storey if such storey –

- (i) forms part of a building of Purpose Group I which has five or more storeys (including the basement storey) or a building or compartment of Purpose Group II to VIII. In the case of Purpose Group I building which has five or more storey (including the basement storey), the basement level shall discharge directly to 1<sup>st</sup> storey grade level.
- (ii) has an area exceeding 100m<sup>2</sup> except that in the case of a building or compartment of Purpose Groups IV, V and VII, the Relevant Authority may consent to exemption from the above requirements provided the building is fitted throughout with an automatic sprinkler system in compliance with the requirements in Chapter 6 and the floor at first basement storey level is constructed as a compartment floor if the building comprises of more than one basement storey.

**EXPLANATIONS & ILLUSTRATIONS**

**3.2.5**

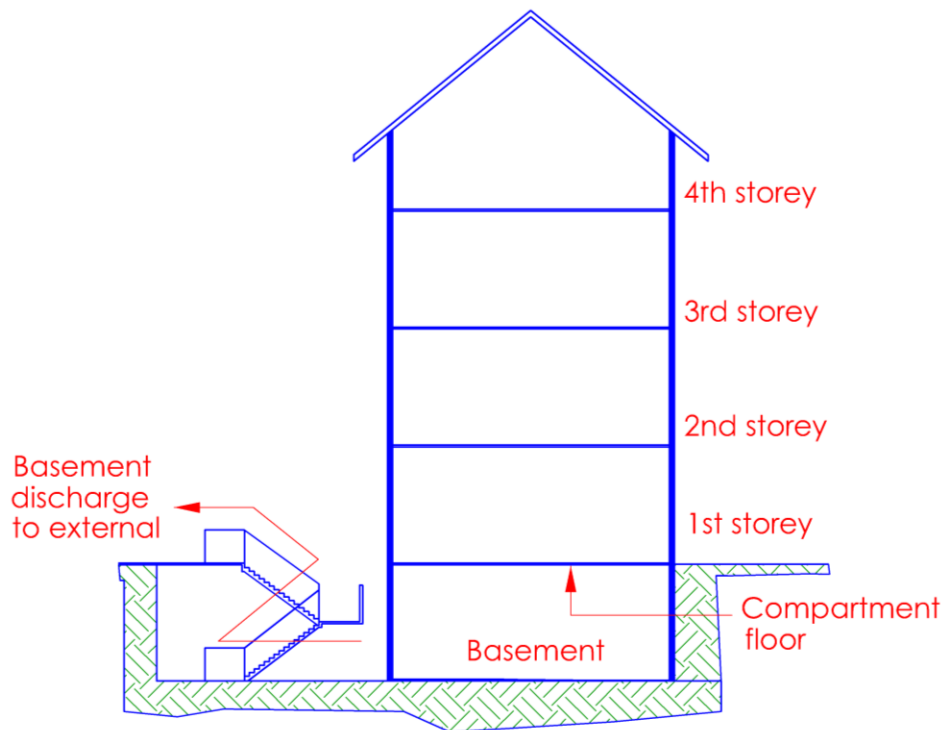

Diagram 3.2.5(c(i)-1

Floor over a basement

*Any floor immediately over a basement storey if such storey forms part of a building of purpose group I which has five or more storey (including the basement storey), shall be constructed as a compartment floor, ie horizontally separating the upper storeys from the basement. The exit staircase serving the basement shall be made to discharge into the exterior at grade level.*



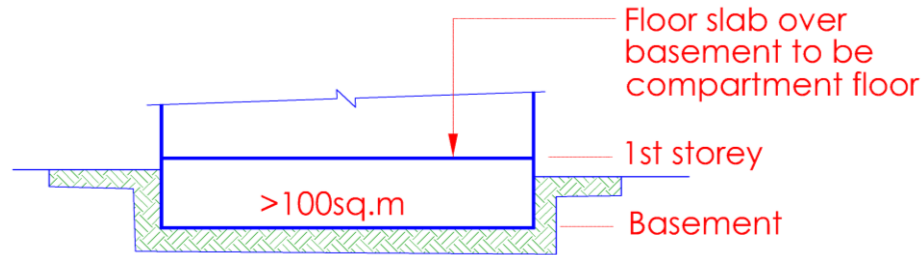

Diagram 3.2.5(c)(ii)-1

Where the floor area of the basement exceeds 100sq.m it shall be a compartment below ground level and shall not comprise more than one storey. The basement floor shall be provided with sprinkler system under clause 6.4.1(d)(i) and dry riser under Cl. 6.2.1(b).

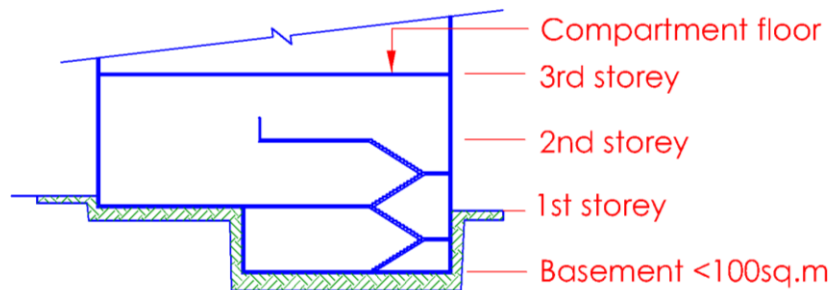

Diagram 3.2.5(c)(ii)-2

In situation where the basement floor area is not exceeding 100sq.m, the basement and upper storeys may be allowed to be interconnected to form one compartment, subject to max. 3 storeys or levels in a single compartment. It should be noted that Cl.3.2.5(d) prohibits more than one storey below ground level to be connected to form one compartment.

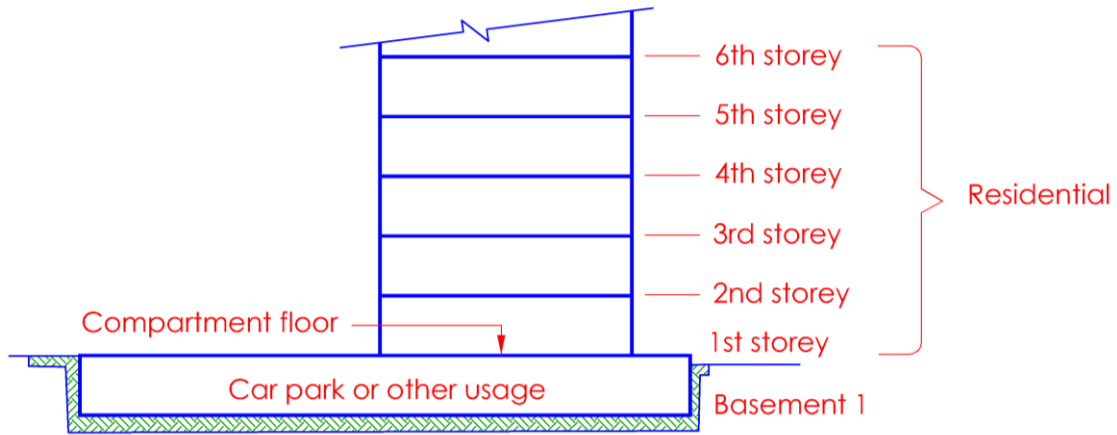

Diagram 3.2.5(c)(ii)-3

All basement floors, except those under Purpose Group I & II, are required to be provided with automatic sprinkler system under cl. 6.4.1(d)(i). Where basement floor, regardless of its area, is interconnected with upper storeys, the automatic sprinkler system required for the basement shall be extended to cover all the upper storeys.

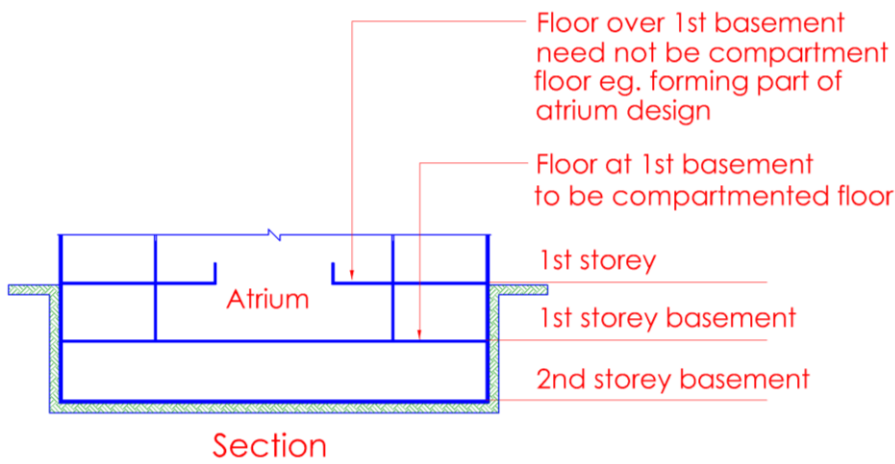

Diagram 3.2.5(c)(ii)-4

For buildings under purpose group IV, V and VII, the first basement floor can be inter-connected with the upper storeys regardless of whether or not it exceeds 100m<sup>2</sup>, provided sprinkler system and smoke control system are provided. Please note that for atrium design, prior consent from SCDF (FSSD) should be obtained before making Building Plan submission. See Cl.3.2.4(c).

Clause 3.2.5(d) prohibits more than one basement floor to be connected to form one compartment, except in the case of basement used solely for car parking.

(d) Basement floors

In any compartment below pavement level, no compartment shall comprise more than one storey, except in the case of Purpose Groups IV, V and VII as permitted under sub-clause (c) (ii) and in the case of basement used solely for car parking. No part of a basement storey shall be used for the bulk storage of highly inflammable liquids or substances of an explosive nature.

**EXPLANATIONS & ILLUSTRATIONS**

**3.2.5 (d)**

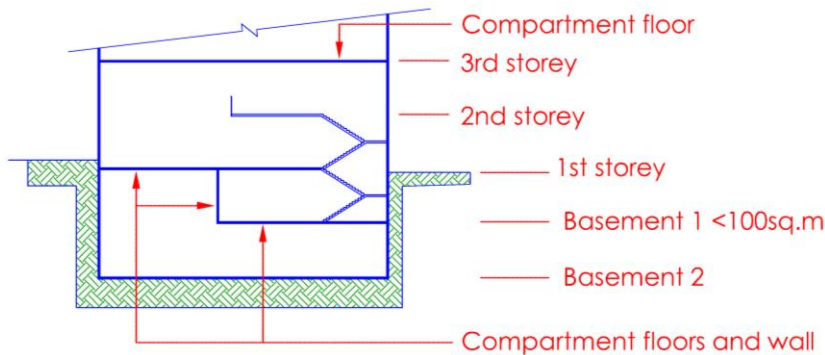

Diagram 3.2.5(d)-1

Basement 1, which has a floor area of less than 100m<sup>2</sup> can be interconnected with 1<sup>st</sup> storey, provided it is compartmented from basement 2. Sprinkler system and rising mains are required to be provided to the building.

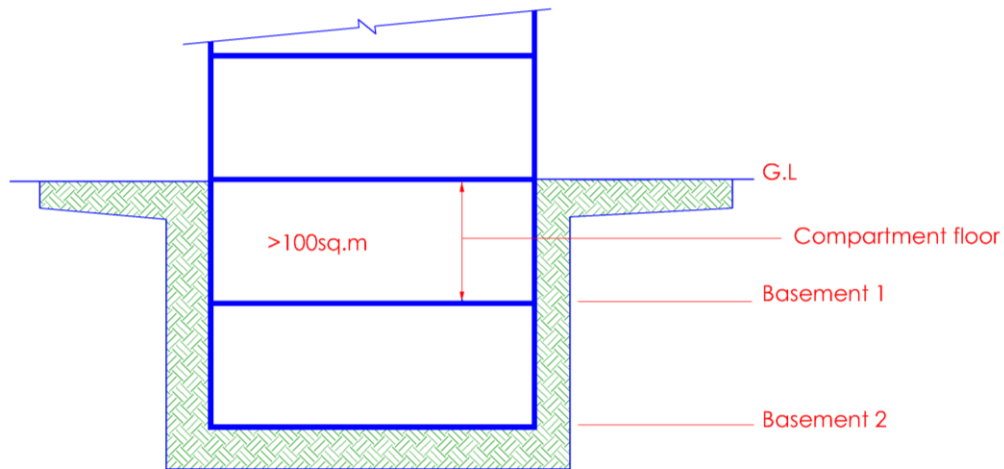

Diagram 3.2.5(d)-2

Basement 1 having a floor area of more than 100m<sup>2</sup> is required to be compartmented from 1<sup>st</sup> storey. The above clause does not permit more than one basement storey per compartment unless solely used for car parking. Sprinkler system and rising main are required to be provided to basement.

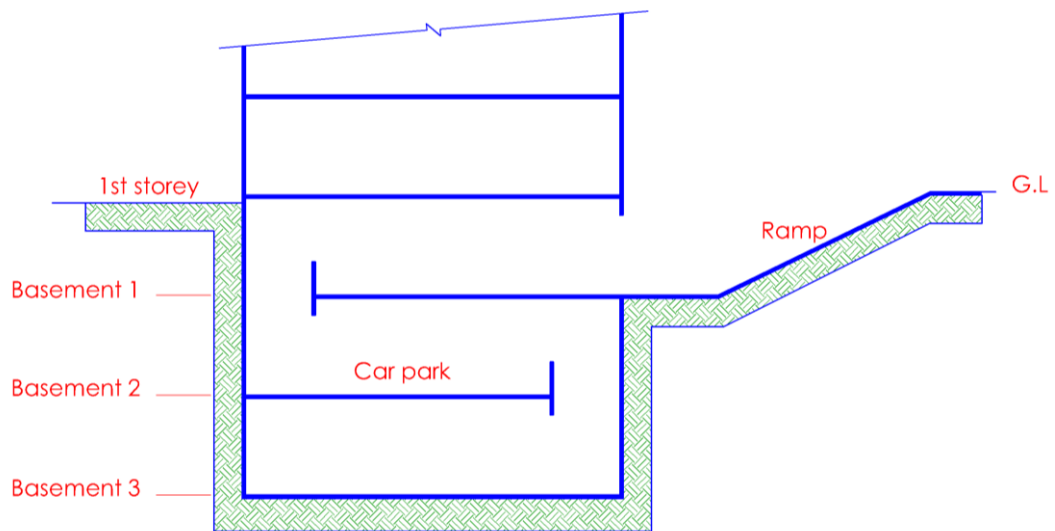

Diagram 3.2.5(d)-3

*Owing to the special use where ramps or car lifts are needed to connect all the floors, compartmentation is relaxed where sprinkler system and rising main are provided.*

(e) Fire Command Centre

The fire command centre shall be separated from other parts of the same building by compartment walls and floors having fire resistance of at least 2 hours.

**EXPLANATIONS & ILLUSTRATIONS**

**3.2.5 (e)**

*No illustration.*

*The fire resistance rating of the walls and floors shall comply with the elements of structure and shall have min. period of 2 hours. Any door opening into the Fire command centre from the occupancy area shall be min. 2 hour fire rated.*

(f) Kitchen Separation

- (i) In an eating establishment where a kitchen is required for the preparation of food and/or where 'open flame' cooking appliances are used, the kitchen shall be separated from other parts of the same building by compartment wall and floor having fire resistance of at least 1 hour;
- (ii) Openings in the compartment wall and floor shall comply with the relevant provisions of Cl.3.9 for protection of openings;
- (iii) Doors shall have fire resistance of half an hour and fitted with automatic self-closing device;

**EXPLANATIONS & ILLUSTRATIONS**

**3.2.5 (f)**

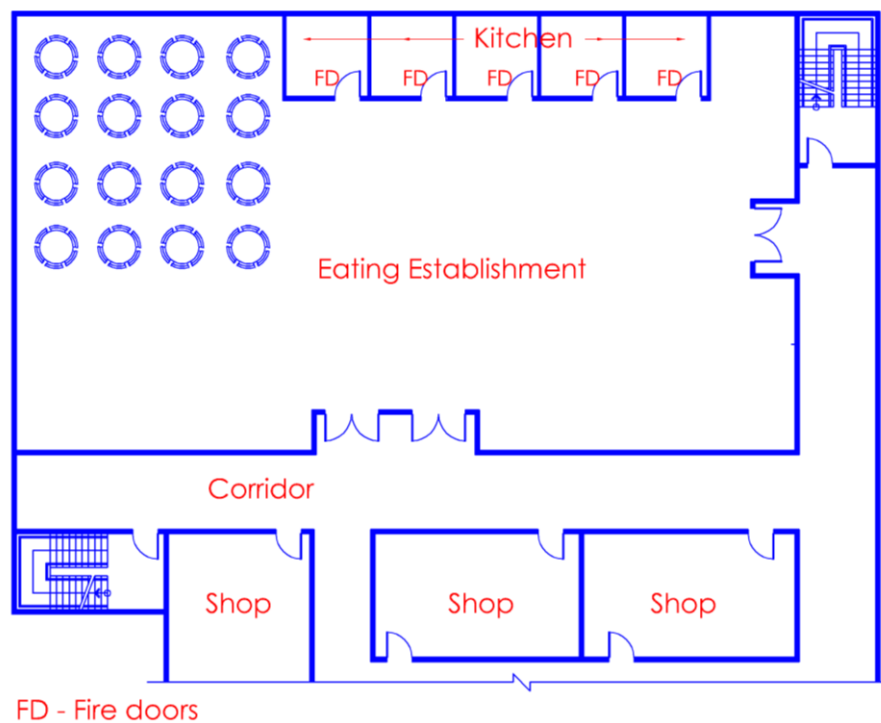

Diagram 3.2.5(f)-1

The above diagram illustrates a eating establishment without kitchen fire-suppression system. The clause enables the QP to exercise the option of compartmenting kitchen with open-flame cooking.

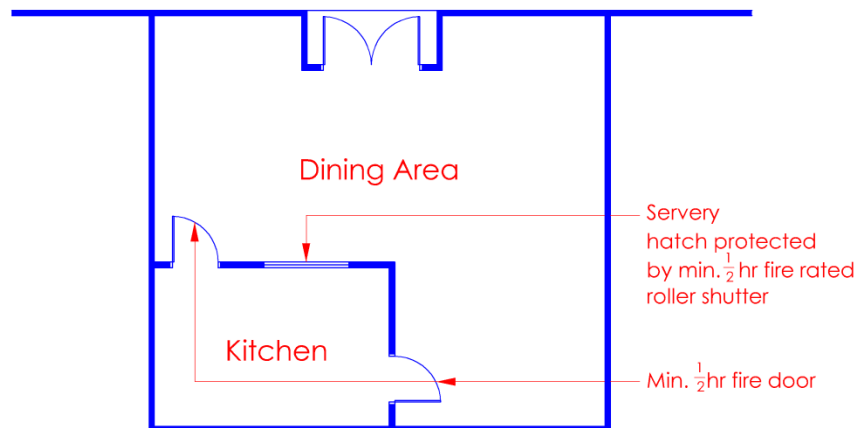

Diagram 3.2.5(f)-2

*Kitchen is compartmented from dining area by 1-hour enclosures and 1/2-hour fire doors. Protection to servery hatch can be a fire rated roller shutter held in the open position by fusible links.*

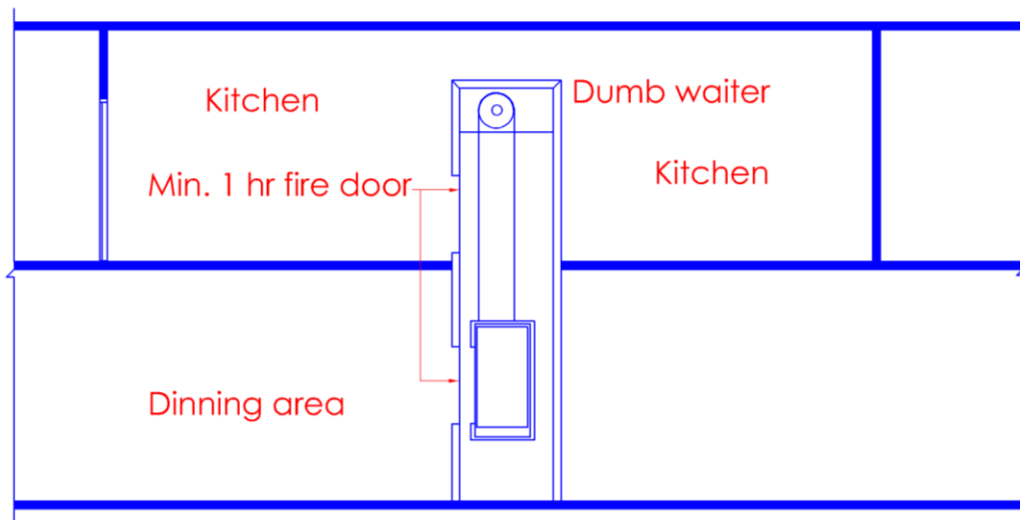

Diagram 3.2.5(f)-3

*As the dumb waiter is connecting 2 storeys, it shall be enclosed in 2-hours protective enclosures with 1-hour fire rated access door at each storey.*

- iv. Where the flue or duct passes through the compartment wall or floor, the flue or duct shall be encased in non-combustible construction to comply with the requirements of Cl.3.9.5 and no damper shall be permitted to be installed in such flue or duct; and

## EXPLANATIONS & ILLUSTRATIONS

## 3.2.5 (f)

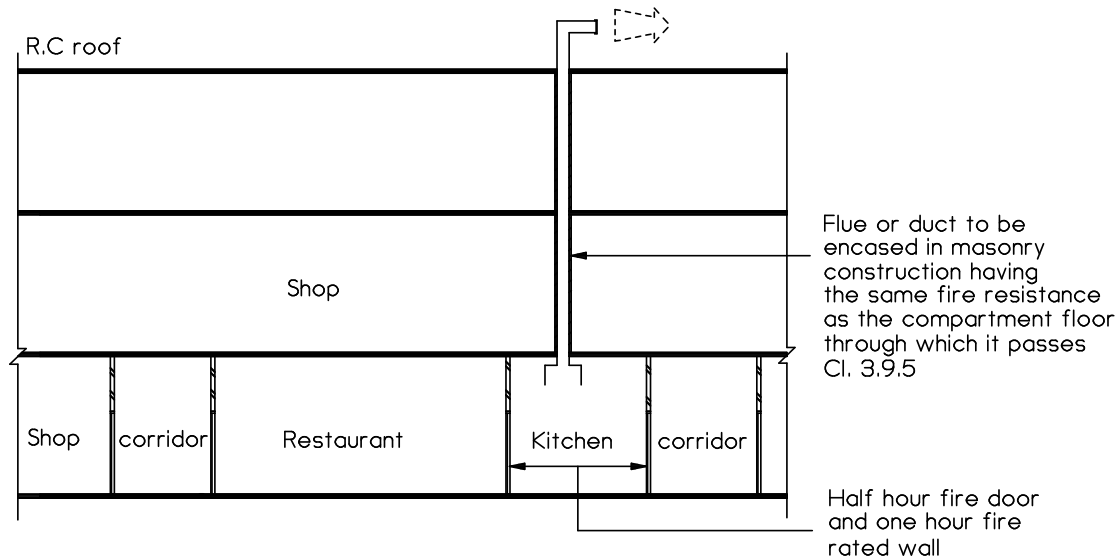

Diagram 3.2.5(f)(iv)

*Kitchen is required to be compartmented from other areas by 1-hour compartment walls and floors. Doors to the kitchen shall have minimum ½-hour fire resistance rating and shall open outward from the kitchen. Small fires which commonly occur in the kitchen are often caused by overheating of cooking oil on the stove or in a deep pan fryer or by grill. Exhaust ducts in kitchen are usually coated with grease internally over a period of time. Fire in the ducts could be started by sparks or by fire from the stove.*

*Cooking appliances include – open flame gas fired oven, charcoal grill and appliances which have open flames located or protected from views.*

*Fire rated door to kitchen shall not be wedged open for serving purpose. In circumstances where fire doors are to be kept open, the door shall be fitted with electro-mechanical device susceptible to smoke under Cl.3.9.2(c). See Cl.1.2.20 of Volume 1 for further illustration.*

*To qualify for non-provision of fire compartment under sub-clause (v), auto fire suppression equipment should be incorporated into the cooking range. This equipment may consist of fixed pipe carbon dioxide, dry chemical or foam- water sprinkler or spray system. Such auto suppression system to the cooking range shall be listed and approved by a certification body.*



- v. Separation requirement for kitchen could be exempted under the following conditions:-
- (1) when all the cooking facilities in the kitchen are fitted with approved extinguishing systems; or
  - (2) when there are at least 25% of the perimeter walls (excluding air-well and void) of an eating establishment open directly to the external of the building, and provided any part of the floor space is within 9m from the nearest opening; or
  - (3) when there are at least 50% of the perimeter walls (excluding air-well and void) of an eating establishment open directly to the external of the building, and provided any part of the floor space is within 12m from the nearest opening; or
  - (4) when an eating establishment is separated from other parts of the same building by walls and floors having fire resistance of at least 1 hour and doors having fire resistance of at least half an hour; and provided –
    - for a sprinkler protected building, there is no restriction to the floor area of the compartment; or
    - for a non-sprinkler protected building, the floor area of the compartment shall not exceed 150m<sup>2</sup>;

LPG cylinders provided for the ‘open flame’ cooking activities are not allowed to be located at the basement and the installation of LPG cylinders at other areas shall comply with the provisions in the Fire Safety (Petroleum) Regulations.

Notwithstanding all the above, the compartment where ‘open flame’ cooking activities is carried out shall not comprise more than one storey

## EXPLANATIONS & ILLUSTRATIONS

3.2.5 (f)

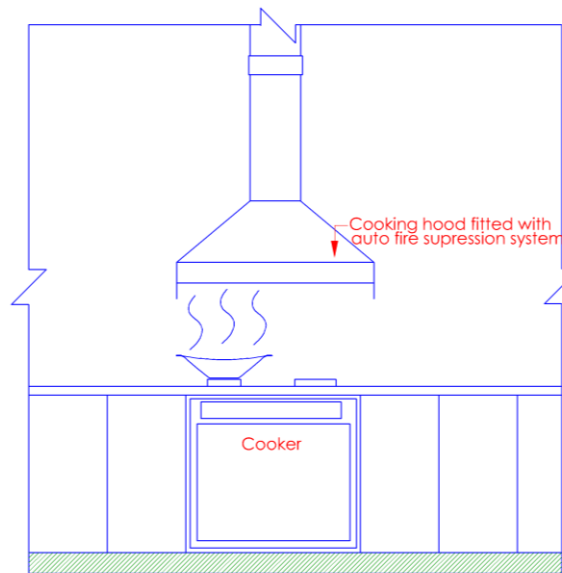

Diagram 3.2.5(f)(v)(1)

*The above sub clause allows the kitchen not to be compartmented if the cooking hood or range is installed with an automatic fire suppression system, bearing PSB Label.*

*With this arrangement, there is no need to seek waiver approval from SCDF “FSSD”.*

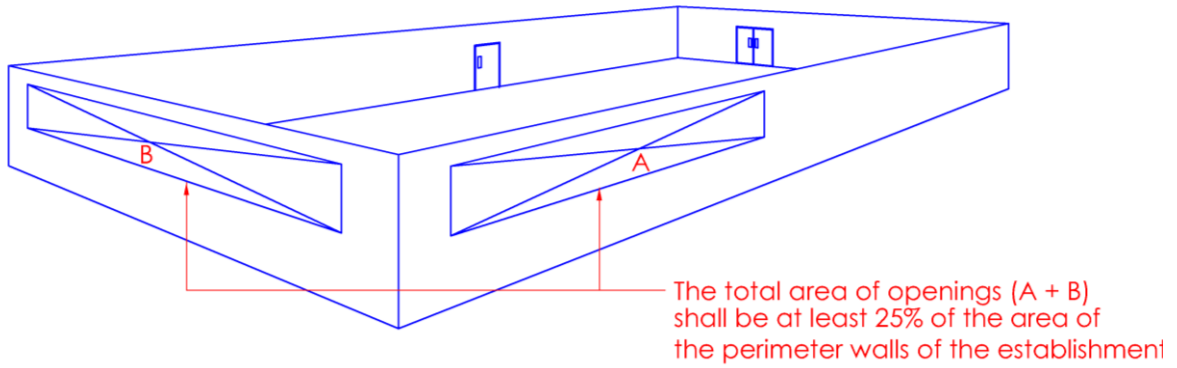

Diagram 3.2.5(f)(v)(2)-1

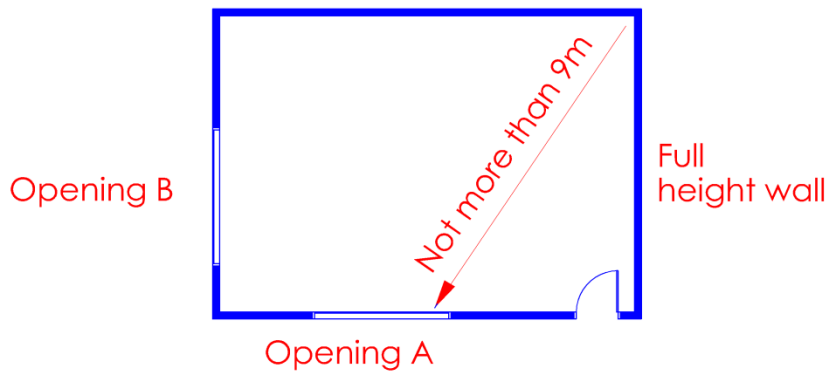

Diagram 3.2.5(f)(v)(2)-2

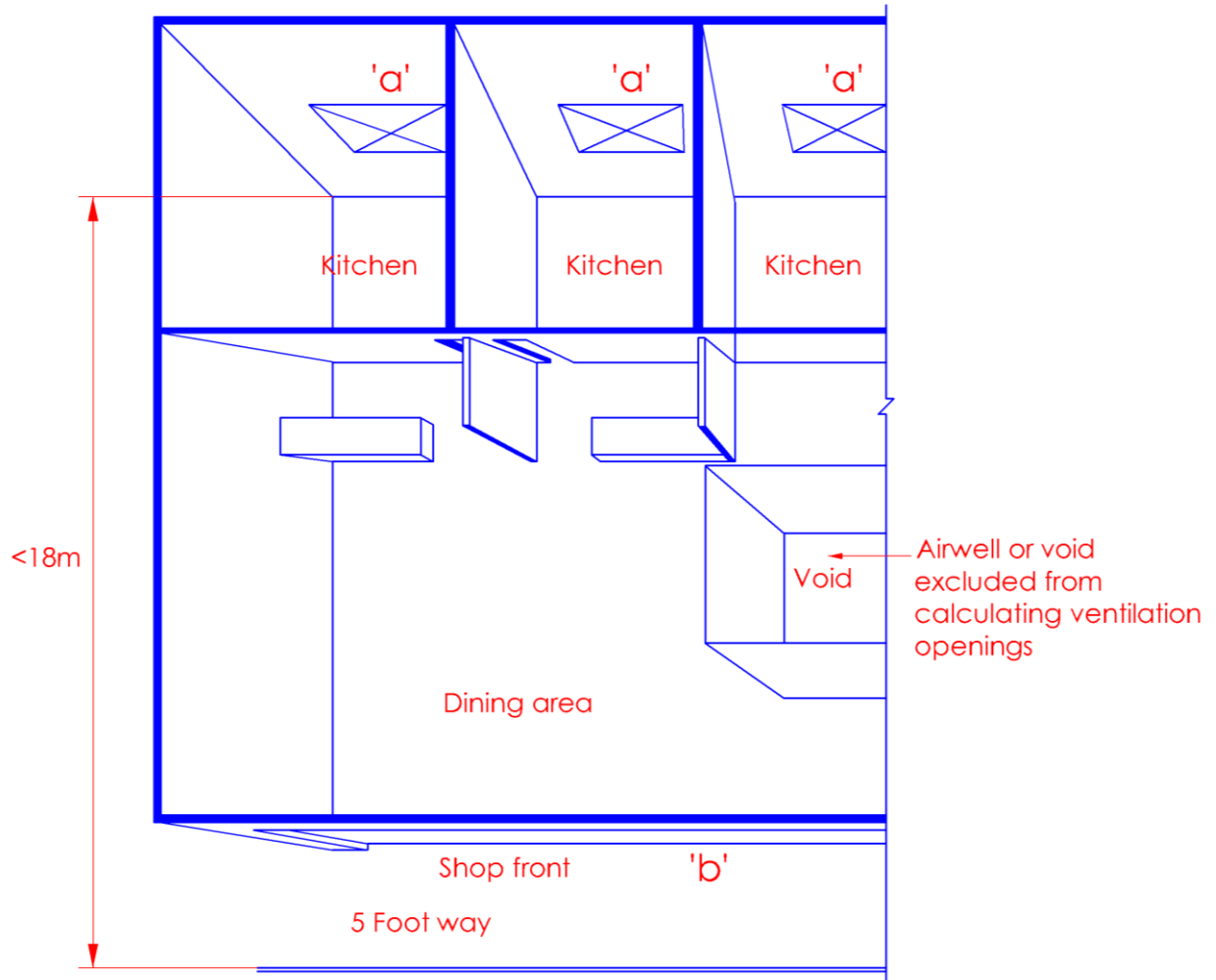
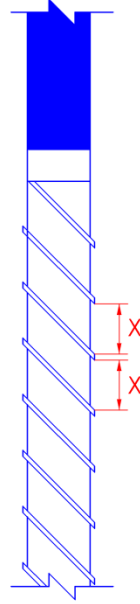

Diagram 3.2.5(f)(v)(2)-3



Section view of fixed louvre window

Diagram 3.2.5(f)(v)(2)-4

*In the above situation, kitchens are not required to be compartmented. Total ventilation openings provided along the external walls of 'a' and 'b', as shown in diagram 3.2.5(f)(v)(2)-3, shall have minimum 25% of the floor area of kitchen and dining. No part of the floor space shall be more than 9m from the external openings. The openings referred to in walls 'a' and 'b' shall be unobstructed vertical openings for the passage of light and air, for example, in the case of fixed louvre window, the net ventilation opening between over-lapping louvres is 'x' as given in the above sectional drawing.*

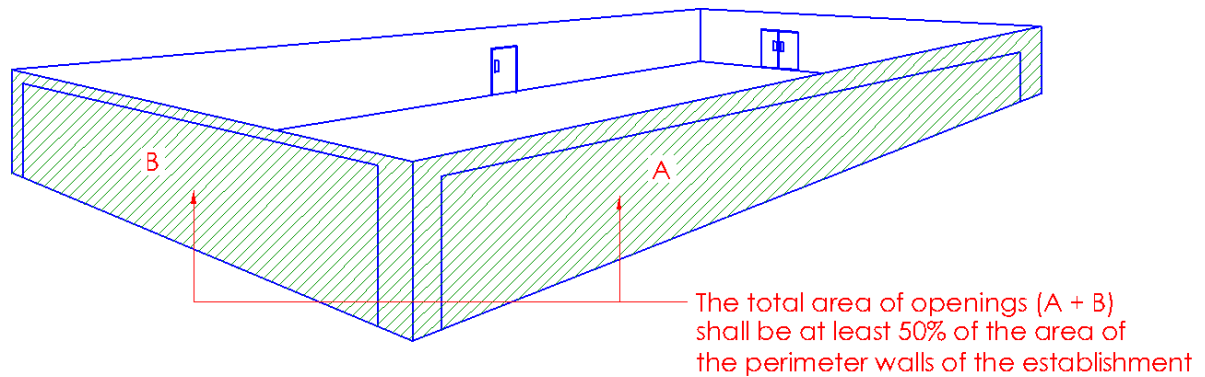

Diagram 3.2.5(f)(v)(3)-1

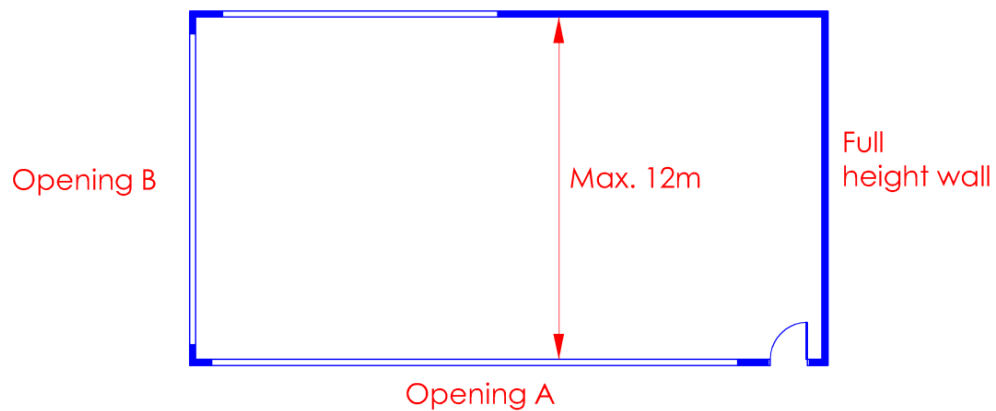

Diagram 3.2.5(f)(v)(3)-2

*The 25% and 50% ventilation openings are required for smoke venting and relief of accumulated heat from the area on fire. This exemption cannot be applied in an enclosed air-conditioned environment, where the peripheral walls are fitted with glass panel.*

*The 25% and 50% ventilation openings are absolute values. Extrapolation of percentage ventilation openings based on depth of the eating establishment is not permitted.*

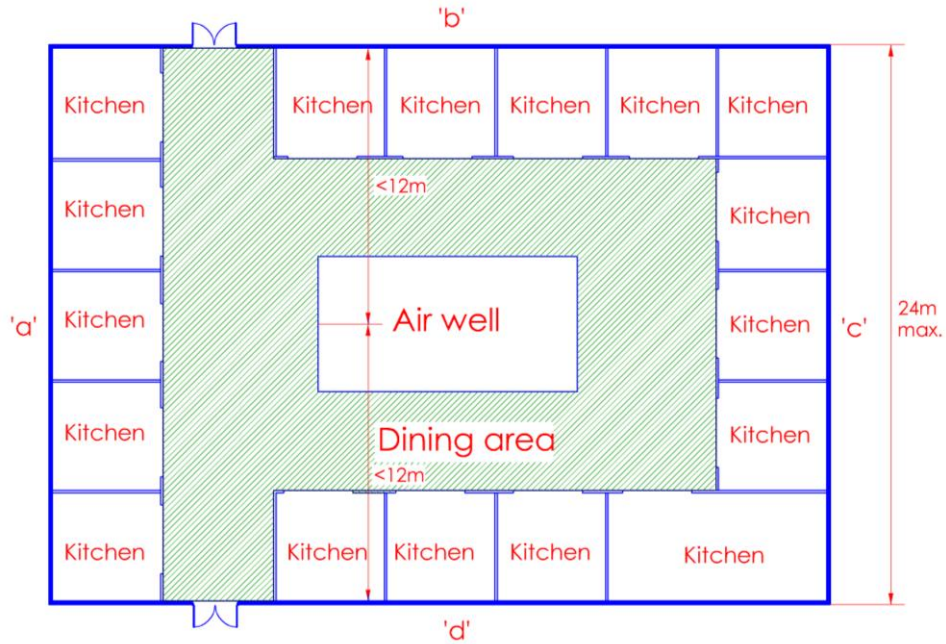

Diagram 3.2.5(f)(v)(3)-3

*In the above diagram the kitchens are not required to be compartmented.*

*Ventilation openings along the external walls 'a', 'b', 'c' and 'd' shall be uninterrupted, having minimum 50% of the perimeter walls of the eating establishment. The openings to the air well shall not be included in this purpose.*

*The above requirement is more relevant to hawker centre type design.*

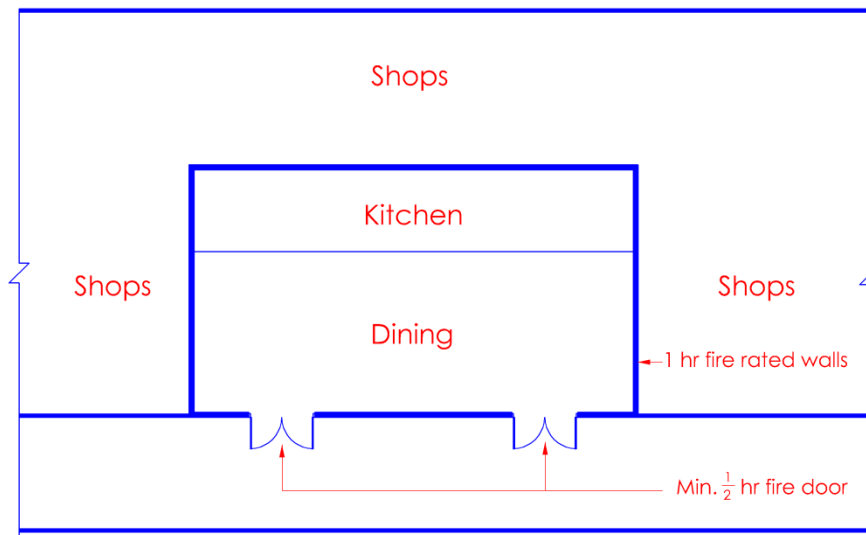

Diagram 3.2.5(f)(v)(4)-1

*Under sub-clause d(i), the kitchen and dining area can be in one compartment, provided the building is sprinkler protected and there is no need restricting to the floor area of the compartment*

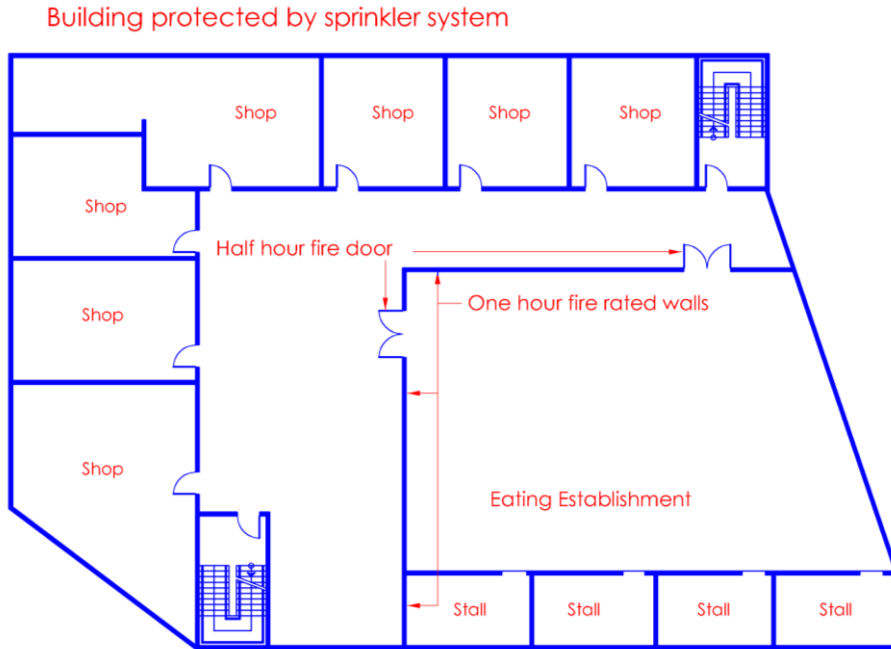

Diagram 3.2.5(f)(v)(4)-2

With the provision of sprinkler system, further relaxation is allowed to permit the whole eating establishment to be enclosed with at least 1 hour fire rated walls and ½ hour fire rated door. There is no restriction to the gross floor area of the eating establishments.

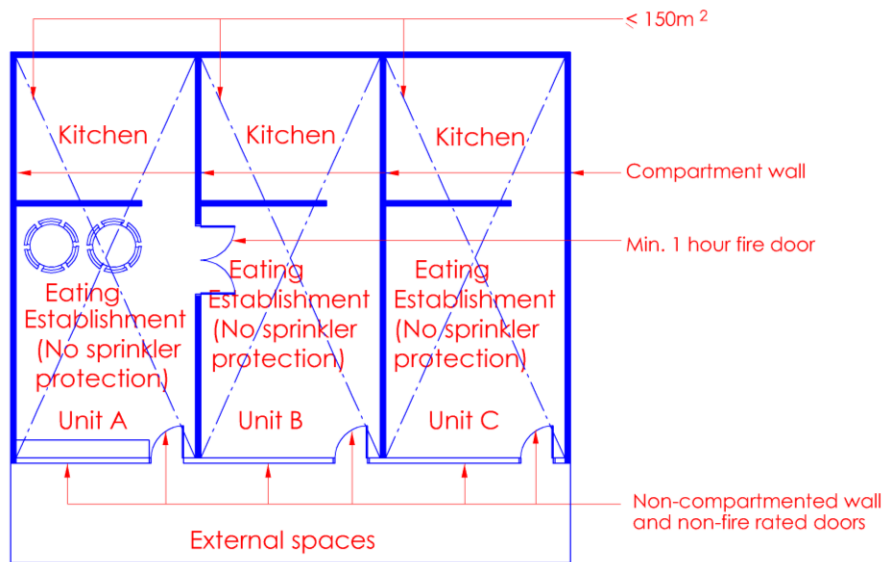

Diagram 3.2.5(f)(v)(4)-3

Under sub clause d(ii) where the building is not sprinkler protected, the area of the compartment, kitchen and dining area e.g (unit A) shall not exceed 150m<sup>2</sup>

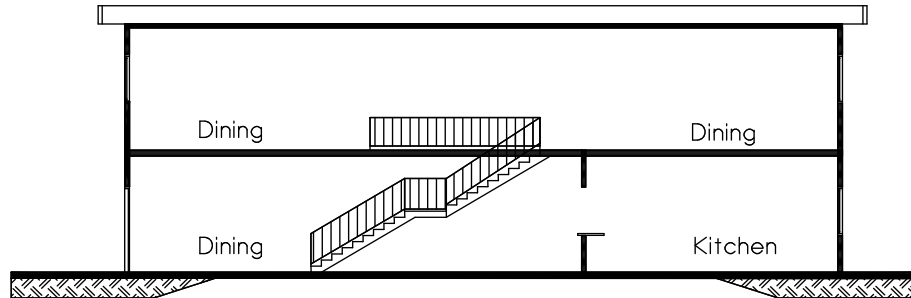

Diagram 3.2.5(f)(v)(4)-4

Where 'open flame' cooking is used, the compartment comprising dining and kitchen areas shall not comprise more than one storey, notwithstanding the following :-

- Building is not sprinkler protected and the compartment does not exceed 150m<sup>2</sup>.
- LPG cylinders shall not be used in any basement storey. However, piped gas is permitted in basement storeys.

In the case of eating establishment which comprises 2 storeys, then each storey shall be a fire compartment by itself.



(g) Separation of theatre, cinema or concert hall from other parts of the building

A theatre, cinema or concert hall shall be separated from other parts of the same building, which is of a different purpose group, by compartment walls and floors having a fire resistance of at least 2-hour. If the building is protected by an automatic sprinkler system, the fire resistance rating of the compartment walls or floors can be reduced to 1-hour. Where openings are provided for access between the theatre, cinema or concert hall and any other part of the same building of a different purpose group, the openings shall either be protected by fire doors having the necessary fire resistance rating as the enclosing walls or floors, or be provided with lobby which complies with the following requirements:

- (i) The lobby is enclosed by walls having fire resistance of at least one hour, is naturally ventilated complying with the requirements for ventilation of smoke-stop lobbies, or mechanically ventilated to comply with the requirements in Chapter 7, and
- (ii) All doors to the lobby shall each have fire resistance of not less than half an hour and fitted with automatic self-closing device.

**EXPLANATIONS & ILLUSTRATIONS**

**3.2.5**

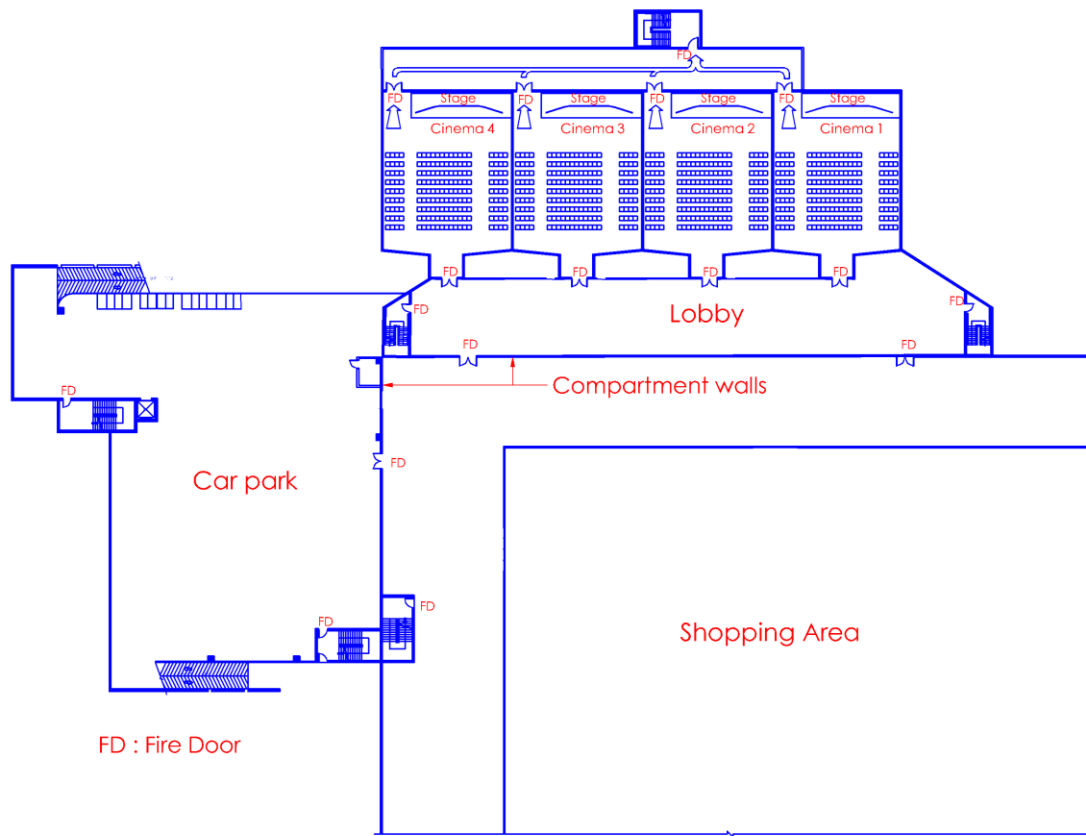

Diagram 3.2.5(g)

(h) Separation by Proscenium Wall in Theatres or Concert Halls

- (i) In a place of public resort, such as theatres, and concert halls, capable of seating more than 500 persons and in which fly tower is used for stage scenery or when extensive stage scenery may normally be installed on the stage side, the stage shall be separated from the seating area by a proscenium wall of not less than 1 hour fire resistance in such a way that the stage and the audience seating area form separate compartments.
- (ii) The proscenium opening shall be protected by fire curtain with fire resistance of at least 1 hour, automatically operated by a fusible link or a smoke detector. In lieu of fire curtain, a smoke curtain is acceptable, if engineered smoke control and automatic sprinkler systems are to be provided to the stage area.
- (iii) Not more than three other openings may be provided in the proscenium wall. Such openings shall not exceed  $2\text{ m}^2$  in area and shall be fitted with doors having fire resistance of not less than half an hour and fitted with automatic self-closing device; and
- (iv) The entire stage side of the proscenium wall shall be fitted with an automatic sprinkler system which complies with the requirements in Chapter 6.

**EXPLANATIONS & ILLUSTRATIONS**

3.2.5

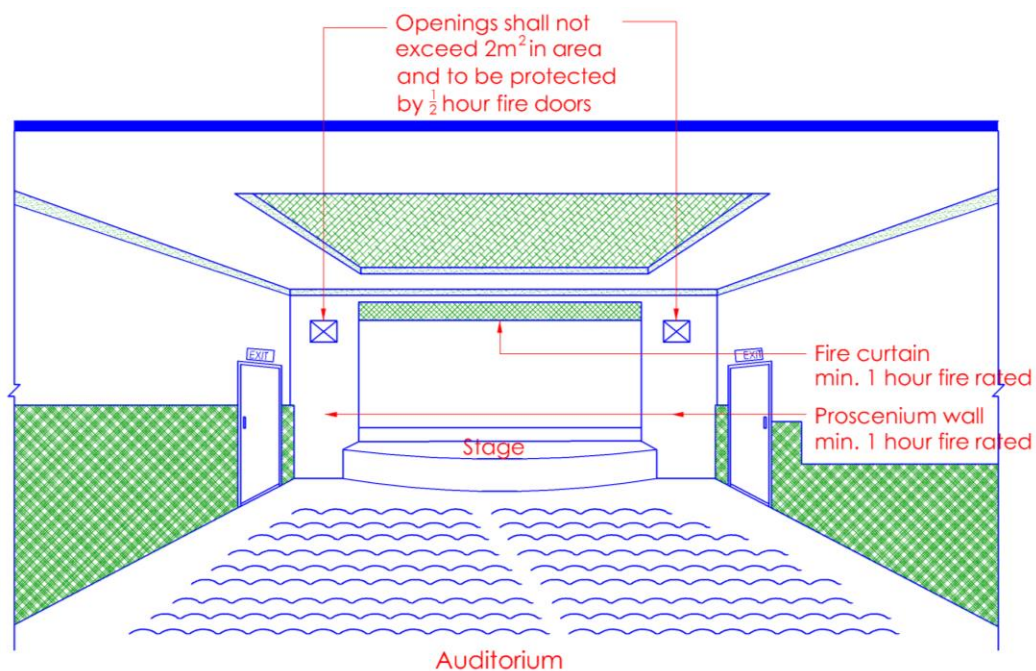

Diagram 3.2.5(h)

*Fire separation between stage and auditorium is required to avoid causing panic to audience owing to a fire outbreak in the stage area.*

(i) Hotel, Boarding Houses, Serviced Apartments, Student Hostels & Back Packers Hotel

(i) Guest room or accommodation unit

Each guestroom or accommodation unit shall be compartmented from adjoining rooms and other parts of the same building by construction having fire resistance rating of at least 1 hour, unless otherwise permitted under Cl.2.7.2 for the provision of window openings between the guestroom or accommodation unit and external corridor, and

(ii) Guestroom or accommodation unit and other rooms or spaces which open into or form part of the guestroom or accommodation unit corridor shall be separated from the corridor to comply with Cl.2.7.1 and Cl.2.7.2.

**EXPLANATIONS & ILLUSTRATIONS**

**3.2.5(i)**

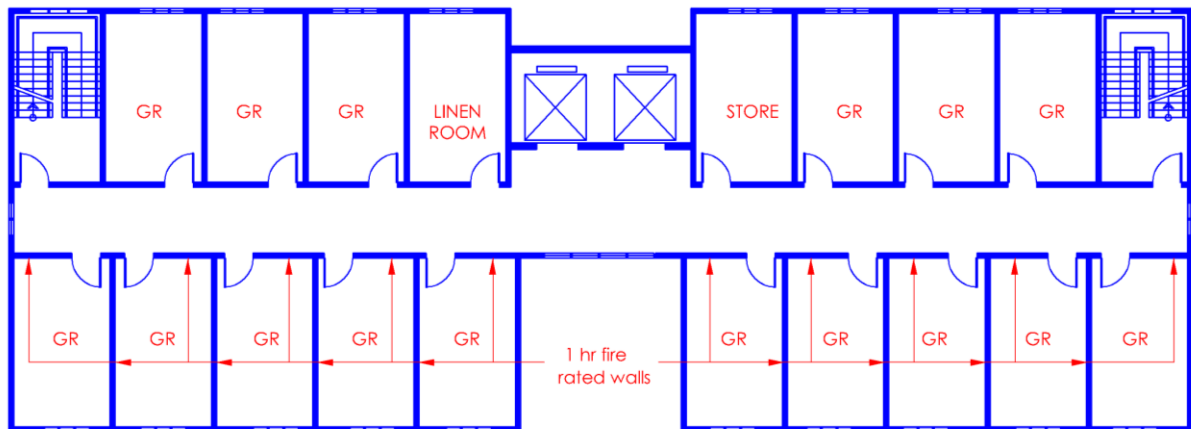

 : Min. ½ hr fire door  
GR : Guest room

Diagram 3.2.5(i)

*Each guestroom is treated as a fire compartment. Similarly, other rooms used as business centre, lounge meeting room etc should also be individually fire compartmented. In the event of fire, the compartmentation provided to each room would help to contain the fire and prevent it from spreading from one room to another. Smoke, which found its way into the internal common corridor, would threaten occupants escaping into protected staircases.*

(j) Workers' dormitories

- (i) Each dormitory bedroom shall be compartmented from adjoining rooms and other parts of the same building by construction having fire resistance rating of at least 1-hour, unless otherwise permitted under C1.2.9.4 for the provision of window openings between the bedroom and external corridor;
- (ii) Dormitory bedrooms and other rooms or spaces which open into or form part of the dormitory bedroom corridor shall be separated from the corridor to comply with C1.2.9.3 and C1.2.9.4; and
- (iii) Kitchen shall be enclosed with minimum 1-hour fire rated compartment wall, including ½-hour fire rated door. Kitchen can be located within each floor, but shall not be within the dormitory bedroom.

**EXPLANATIONS & ILLUSTRATIONS**

**3.2.5**

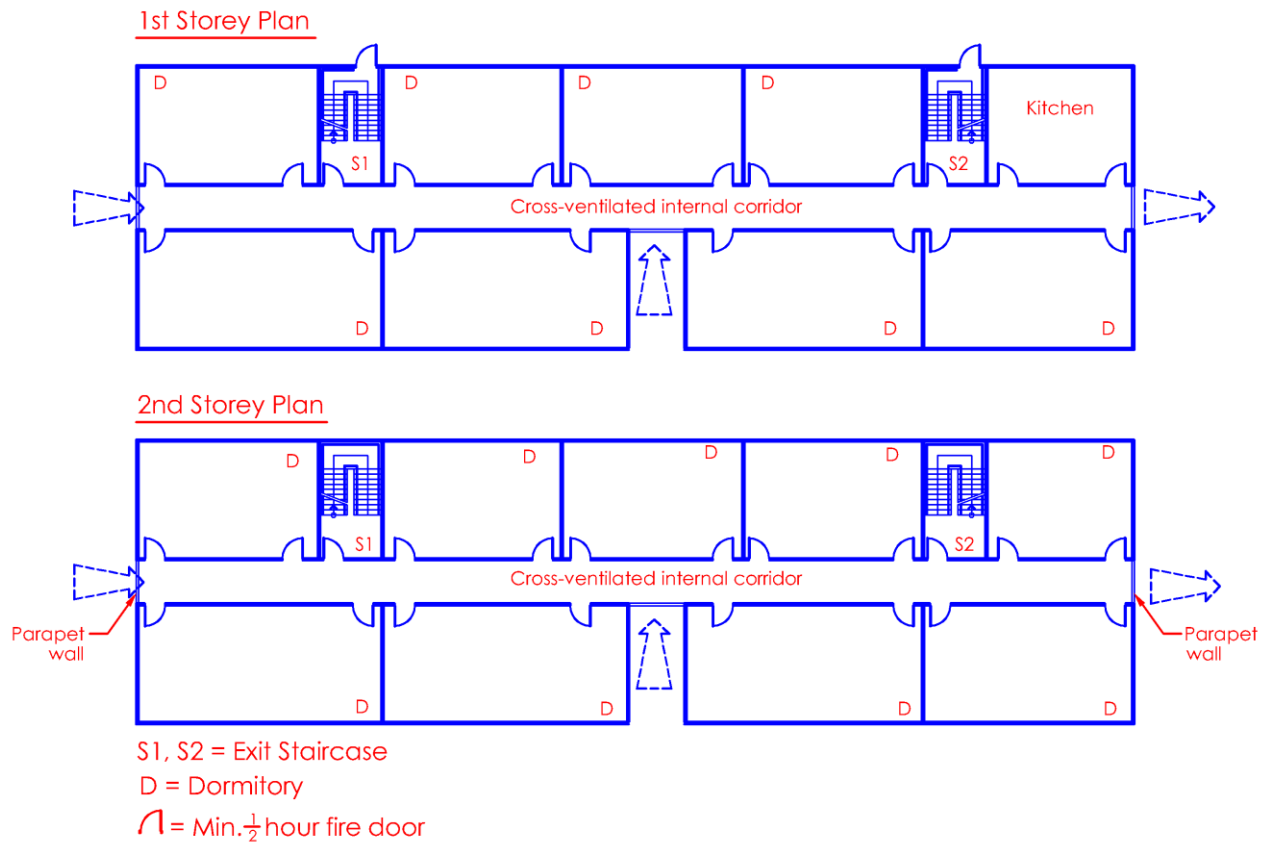

*Diagram 3.2.5(j)(i)-1*

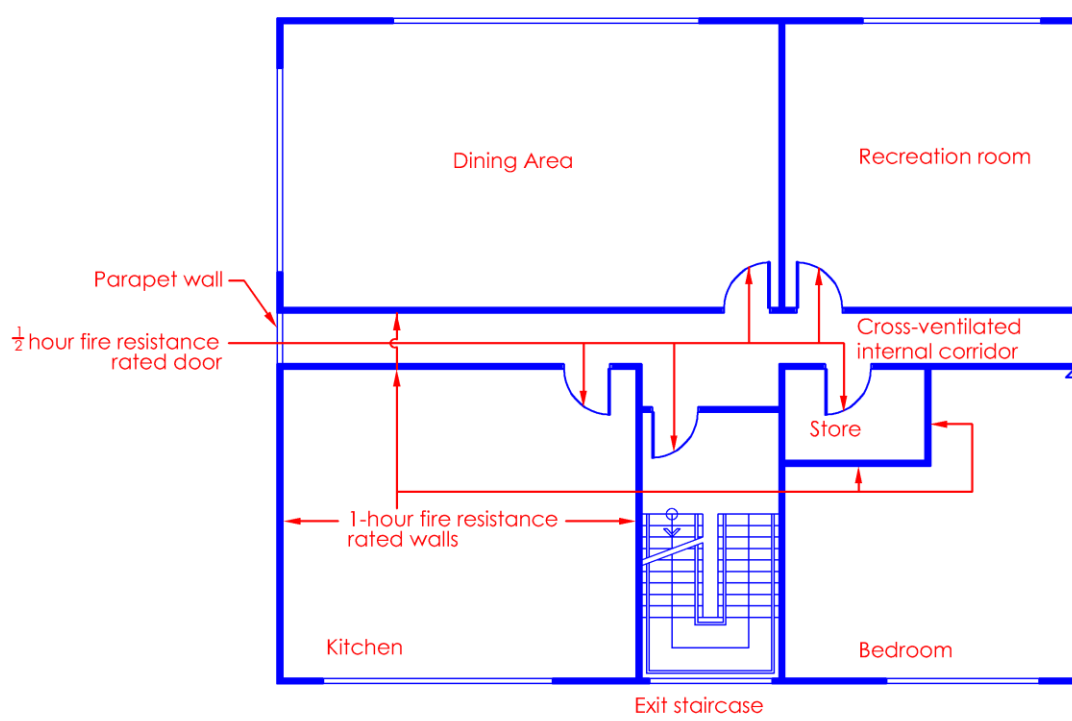

Diagram 3.2.5(j)(i)-2

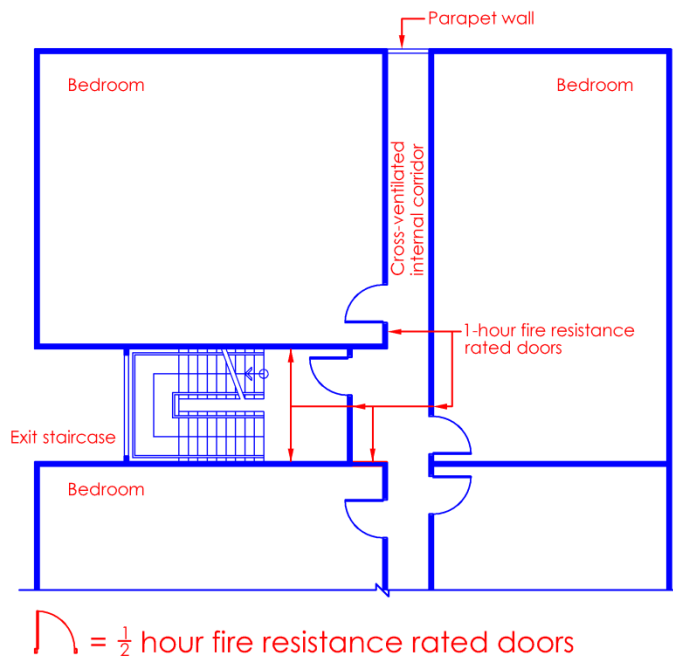
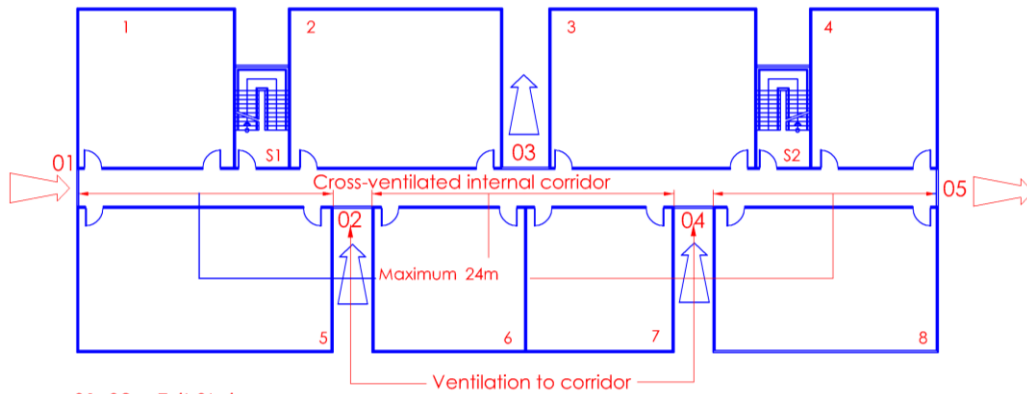

Diagram 3.2.5(j)(ii)-1

Ventilation of internal corridors to worker's dormitory



S1, S2 = Exit Staircase  
 01 - 05 = Openings to internal corridor for natural ventilation

Diagram 3.2.5(j)(ii)-2

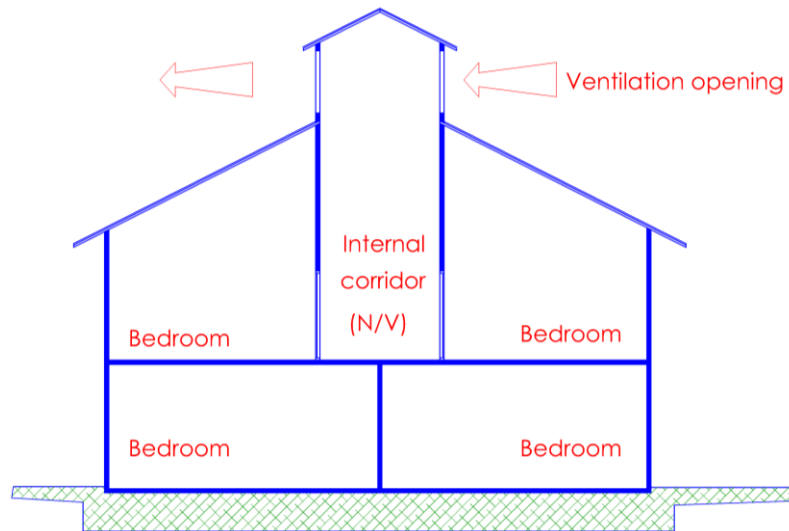

Diagram 3.2.5(j)(ii)-3

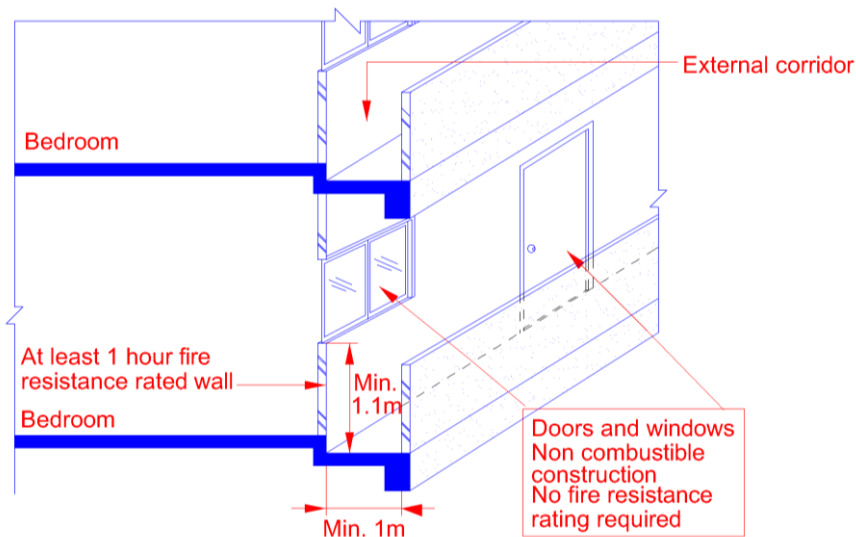

Diagram 3.2.5(j)(iii)

(k) Separation of motor vehicle workshop

A motor vehicle workshop shall be separated from any other part of the same building by compartment walls and floors having fire resistance of not less than 2 hours, and if located in a basement storey of a building, shall be separated from any other part of the same building by compartment walls and floors having fire resistance of not less than 4 hours.

**EXPLANATIONS & ILLUSTRATIONS**

**3.2.5**

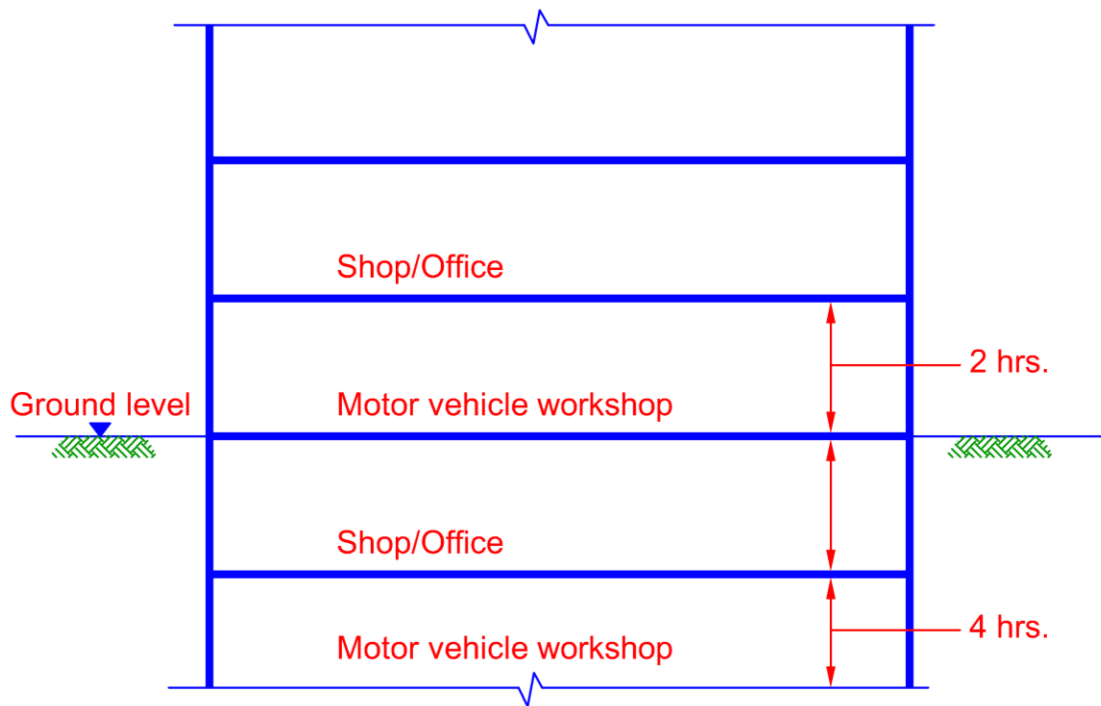

*Diagram 3.2.5(k)*

(l) Separation of painting room

- (i) Areas in which spray painting or other allied processes are performed or carried out, shall be separated from other parts of the same building by compartment walls and floors having fire resistance of not less than 2 hours. Where spray painting booths that have built-in vapour extraction system complying with NFPA 33, the fire resistance requirement is not applicable.
- (ii) Where a spray painting room or booth is protected by an automatic sprinkler system but not complying with NFPA 33, the fire compartment to the room or booth can be reduced from 2 hours to 1 hour.

**EXPLANATIONS & ILLUSTRATIONS**

**3.2.5**

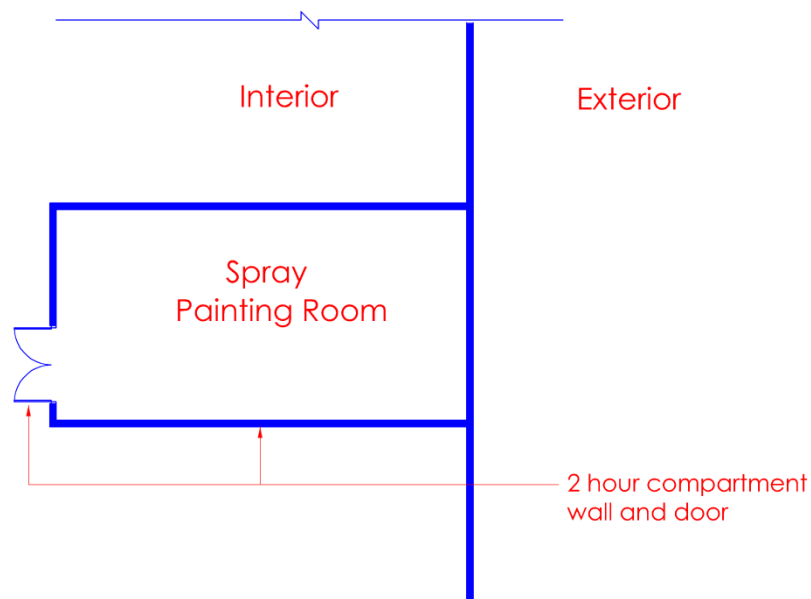

*Diagram 3.2.5(l)*

*Spray painting booth or room shall be mechanically ventilated and enclosed in min. 2 hour fire rated compartment to allow spraying of paint to be carried out. It shall be constructed to prevent the escape of spray and flammable vapour which shall be removed by the exhaust system.*

*The exhaust discharge point shall be not less than 5m from the inlet of any mechanical ventilation system.*



(m) Coldroom

A coldroom is a store room used for the storage of materials or chemical under cold temperature. The enclosures to the coldroom are constructed partly or wholly of highly combustible insulation materials. The floor area shall be the aggregate floor areas of all the coldrooms located in a compartment or a unit.

- (i) Where a coldroom has a floor area exceeding 10m<sup>2</sup>, a separate outer layer of non-combustible construction, including the door, having minimum 1-hour fire resistance rating, shall be provided to compartmentalise the coldroom enclosure from other areas.
- (ii) Provision of the fire resisting outer layer enclosure, including the fire door to the coldroom would not be required if :
  - (1) The coldroom has a floor area not exceeding 20m<sup>2</sup> and is sprinkler protected in a building under Purpose groups III, IV, V, VI, VII or VIII, and the storage materials shall not include highly flammable chemicals.
  - (2) The coldroom is located in a building under Purpose Groups I or II.
  - (3) The coldroom is located in a kitchen compartment (with or without 'open flame' cooking appliances) in an eating establishment, provided the floor area of the coldroom does not exceed 20m<sup>2</sup>, and the kitchen is compartmentalised from other parts of the building by compartment walls and floor having minimum 1- hour fire resistance and door having minimum ½-hour fire resistance, irrespective of the relaxation allowed under Cl.3.2.5(f)(v).
- (iii) The insulation material for the coldroom shall pass Class B under BS EN 13501 or its equivalent.

**EXPLANATIONS & ILLUSTRATIONS**

**3.2.5**

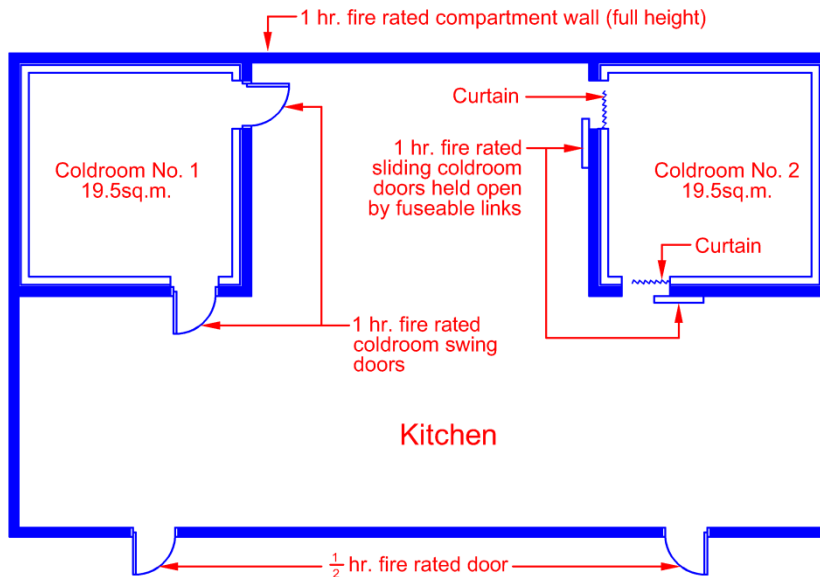

Diagram 3.2.5(m)-1

As the aggregate floor area of the coldrooms No. 1 and 2 is greater than 20 sq. m, each coldroom is to separately fire compartmented with one hour fire compartment walls and fire door. The 1-hour fire rated coldroom doors, swing or sliding type, are accepted for use, provided they are tested and listed by a recognized certification body.

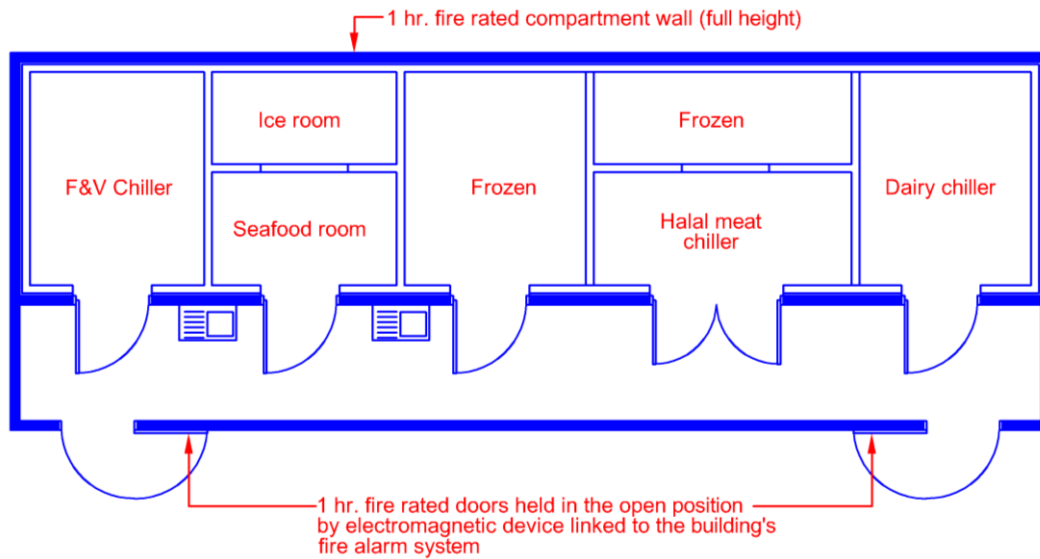

Diagram 3.2.5(m)-2

The main concern about coldrooms is the use of combustible insulation materials for the construction of the coldroom walls, ceilings and floors. The insulation material is usually polystyrene or polyurethane which when subject to a fire would burn vigorously to release great amount of heat and thick poisonous fumes.

The above diagram illustrates a cluster of coldrooms in a supermarket, which is sprinklered protected. The aggregate floor area of the coldrooms is more than 20 sq m. Hence, the provision of 1-hour fire rated outer skin of compartment walls and doors would be necessary.

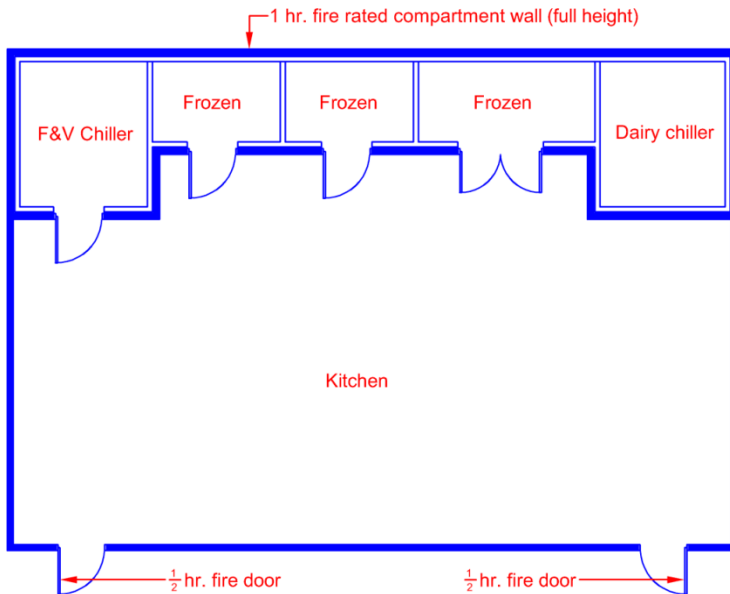

Diagram 3.2.5(m)-3

The aggregate floor area of all the coldrooms shall not exceed 20sq m if located in a kitchen that is enclosed with 1-hour fire rated compartment walls and 1/2 -hour fire door.

(n) Store room

For non-sprinklered buildings, if the area of the store room exceeds 10m<sup>2</sup>, it shall be compartmented from the other parts of the same building by compartment walls and floors having fire resistance of not less than 1 hour. No fire compartmentation is required for a store room which is housed within a sprinklered protected building. However store room exceeding 700m<sup>2</sup> and 100m<sup>2</sup> for above-ground and below-ground respectively are subject to the compartment size requirements stipulated under Appendix (4).

**EXPLANATIONS & ILLUSTRATIONS**

**3.2.5**

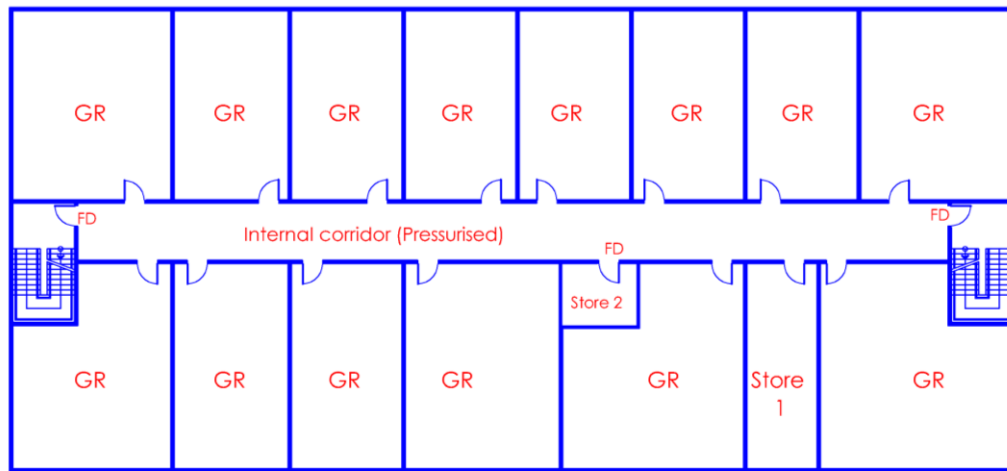

GR : Guest Room  
FD : ½ hour fire door

Diagram 3.2.5(n)

*Store 1 exceeding 10m<sup>2</sup> inside a Hotel space will need to be compartmentalised with 1- hour fire rated enclosures.*

*Store 2 which is less than 10m<sup>2</sup> still required to be provided with fire door as the store opens into internal corridor, which is pressurised.*

*The main reason for compartmentation of storeroom is to prevent undetected fire in the storeroom from developing into a big fire.*

**Compactus**

*Compactus room which is more than 10m<sup>2</sup> shall be treated as a compartment under the above sub-clause. The enclosing walls/floor/ceiling/door shall have min. 1 hour fire resistance rating. Irrespective of the location of the compactus storage area, if it is not enclosed in a room, it shall be treated as open storage shelves and not as a store. The main reason is that a fire occurring in a room could be unnoticed, until it becomes too big to be put out by first aid fire fighting equipment. An incipient fire occurring in an unenclosed compactus storage area could be easily spotted by occupants and immediate reaction could be taken to put out the fire.*

*Any store, regardless of its size, shall be compartmented under the above sub-clause if it opens directly into exit passageways and designated protected escape routes, e.g. smoke stop lobbies, protected staircases.*

(o) Areas of special high risk in a building

Areas of Special Hazard

- (i) Boiler rooms, transformer rooms, generator rooms, storage areas of materials that are highly combustible or flammable, and any other area of special high risk shall be separated from other parts of the building by compartment walls and floors having fire resistance of not less than 2 hours. If the building is protected by an automatic sprinkler system, the fire resistance rating of the compartment walls and floors can be reduced to 1 hour.
- (ii) Rooms housing transformer containing flammable liquid and generator rooms shall be located against an external wall.

**EXPLANATIONS & ILLUSTRATIONS**

**3.2.5**

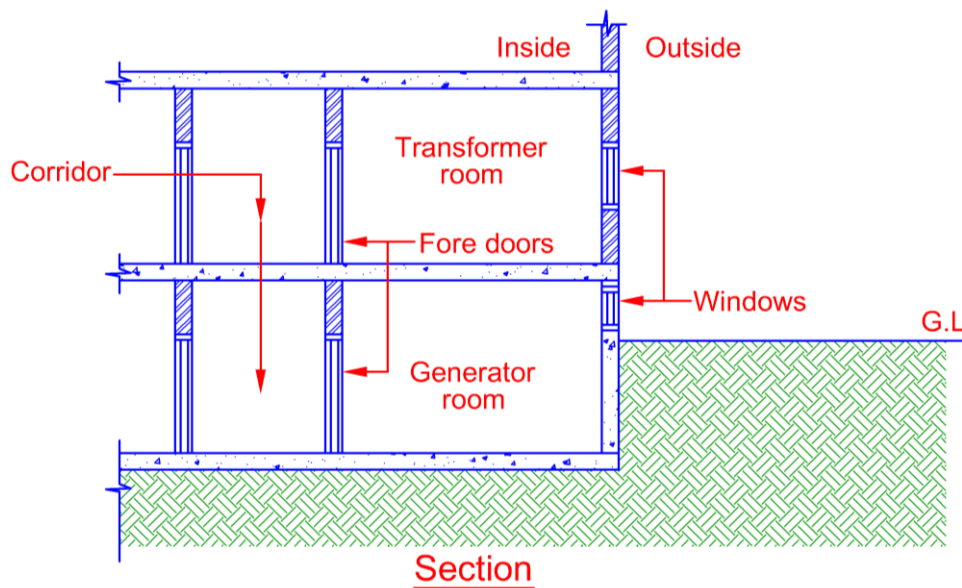

Diagram 3.2.5(o)

*Transformer and generator rooms that contain flammable liquids should be located against an external wall for external ventilation and explosion relief.*

Transformer room

*Transformers could be dry type or oil cooled type. Oil cooled type is to be located against an external wall above ground level to allow for external ventilation and explosion relief. Adequate precautions should be taken by the provision of a suitable catch pit or other means to prevent the spread of fire resulting from leakage and ignition of oil.*

*Generator rooms*

*Generator sets shall be located in clean, dry locations within fire rated compartments. They may be placed outdoors if they are of purpose built type, provided proper separation from unprotected openings of the building is maintained. Generator rooms shall be located against an external wall above ground level to allow for external ventilation and explosion relief.*

*Storage areas of highly combustible or flammable materials*

*Where possible, oil storage tanks should be installed in open air at ground level at least 6m from adjacent buildings and in accordance with CP 40. A max. capacity of 700 litres of diesel oil is permitted to be stored in the generator room. The oil drum/s shall be located within a bunded area, capable of containing 100% spillage from the drum/s.*

*Prior approval is to be obtained from SCDF (FSSD) for storage of combustible or flammable liquids, other than in the generator room, before building plan submission.*

(p) Tenancy unit

Fire compartmentation between individual tenancy units within a terraced or flatted factory or warehouse building shall be provided. The entire enclosure of each of these units shall be fire compartmented with walls and floors of minimum one-hour fire resistance rating.

**EXPLANATIONS & ILLUSTRATIONS**

**3.2.5**

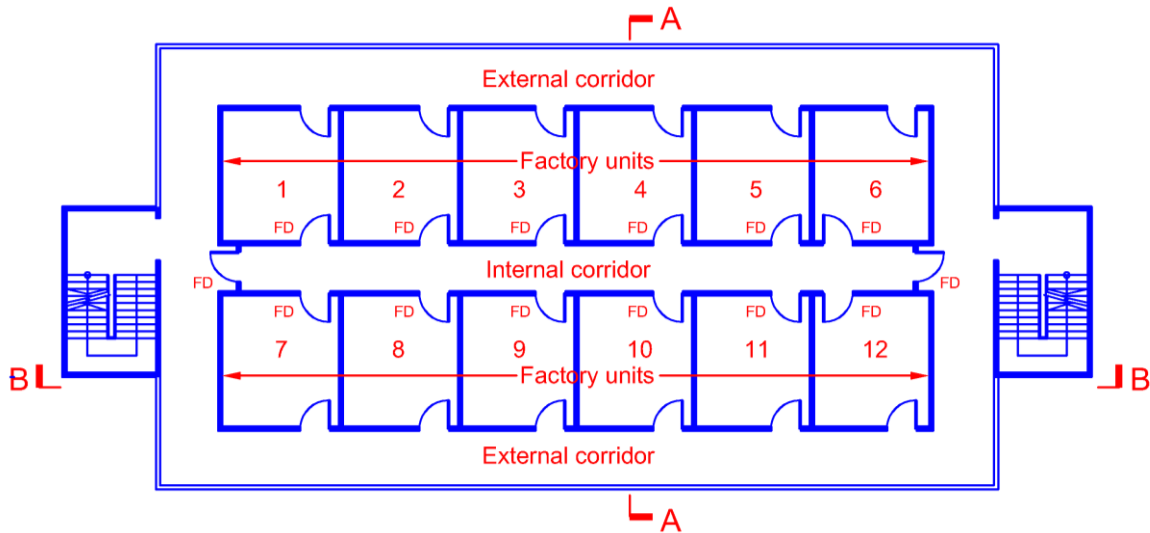

Diagram 3.2.5(p)-1

*Enclosing walls and doors to internal corridor are required to be constructed of non-combustible materials having the necessary fire resistance rating. Walls and doors facing the external corridor are not required to be fire rated.*

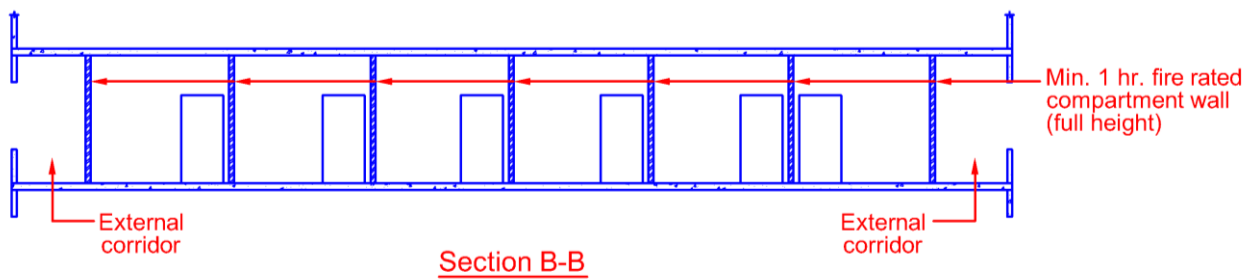

Diagram 3.2.5(p)-2

*Compartment wall between units are required to be constructed of non-combustible materials having minimum 1-hour fire resistance rating.*

(q) Car parking area

Fire compartment between car parking area (Purpose Group VIII) and other areas shall be provided. The fire compartment walls and floors shall have minimum one-hour fire rating.

**EXPLANATIONS & ILLUSTRATIONS**

**3.2.5**

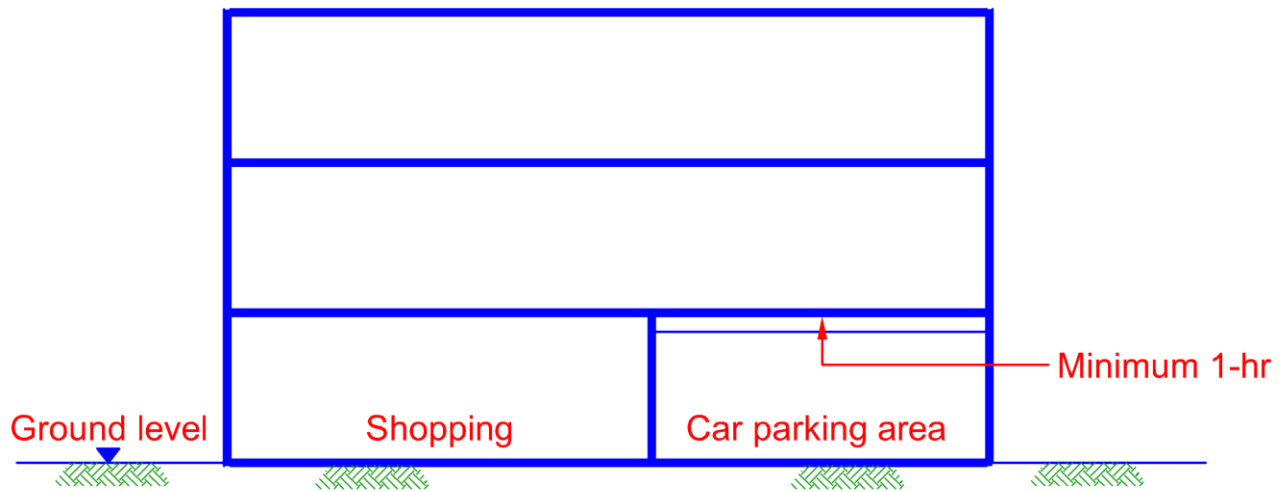

Diagram 3.2.5(q)

(r) Warehouse

Warehouse compartment size exceeding 700m<sup>2</sup> for above ground level and 100m<sup>2</sup> for below ground level are subject to full compliance of Appendix (4).

**EXPLANATIONS & ILLUSTRATIONS**

**3.2.5**

*No illustration.*

*For general warehouses, reference could be made to Appendix (4) for more information.*



# CHAPTER 3

## 3.2 PROVISION OF COMPARTMENTWALLS AND COMPARTMENT FLOORS

### 3.2.6 Provision for atrium spaces

The Relevant Authority may consent to modify the requirements under Cl. 3.2.1 and 3.2.4(a) of this Code for the design of 'Atrium spaces' in a building provided the following conditions are complied with :

- (a) The minimum plan area of the Atrium void shall be not less than 93 m<sup>2</sup> and no horizontal dimension between opposite edges of the floor opening is less than 6 m wide; and
- (b) Occupancy within the floor space of the Atrium meets with the specification for low or ordinary hazard content; and
- (c) The atrium is open and unobstructed in a manner such that it may be assumed that a fire in any part of the space will be readily obvious to the occupants before it becomes a hazard; and
- (d) The building is fitted throughout with an automatic sprinkler system to comply with the requirements in Chapter 6; and
- (e) The building is fitted with an engineered smoke control system in accordance with Cl.7.6; and
- (f) Provision of openings and enclosures, and the planning of means of escape shall be subject to the approval of the Relevant Authority.

### EXPLANATIONS & ILLUSTRATIONS

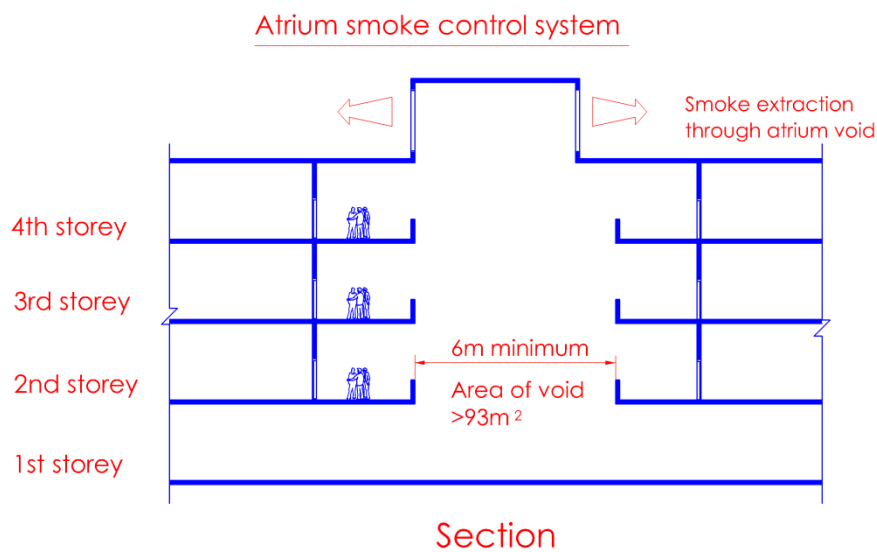

Diagram 3.2.6-1

- (i) *The above clause allows the SCDF (FSSD) to vary the max. floor area/cubical extent of fire compartment to allow more than 3 storeys to be interconnected. The critical points for consideration would include the size and configuration of atrium void and the provision of sprinkler system and engineered smoke control system.*
- (ii) *QPs should consult SCDF (FSSD) in cases of all atrium designs before making building plan submission. The vetting will confine only to looking at the concept and the layout and profile of atrium void in the building proposal only. Calculations for the engineered smoke control system shall be submitted separately by M&E qualified persons.*
- (iii) *Where a compartment in a building has a total floor area and cubical extent greater than that allowed under Table 3.2A, but the number of floor interconnected by void does not exceed 3 floors, QPs should consult SCDF (FSSD) whether there is a need to provide engineered smoke control system, before making building plan submission. Similarly, if a compartment in a building has a total floor area and cubical extent greater than that allowed under Table 3.2A and the number of floor interconnected by void is more than 3 floors, QPs should consult SCDF (FSSD) before making building plan submission. The consultation would confine to vetting of requirements mentioned in sub-clause (ii) above.*

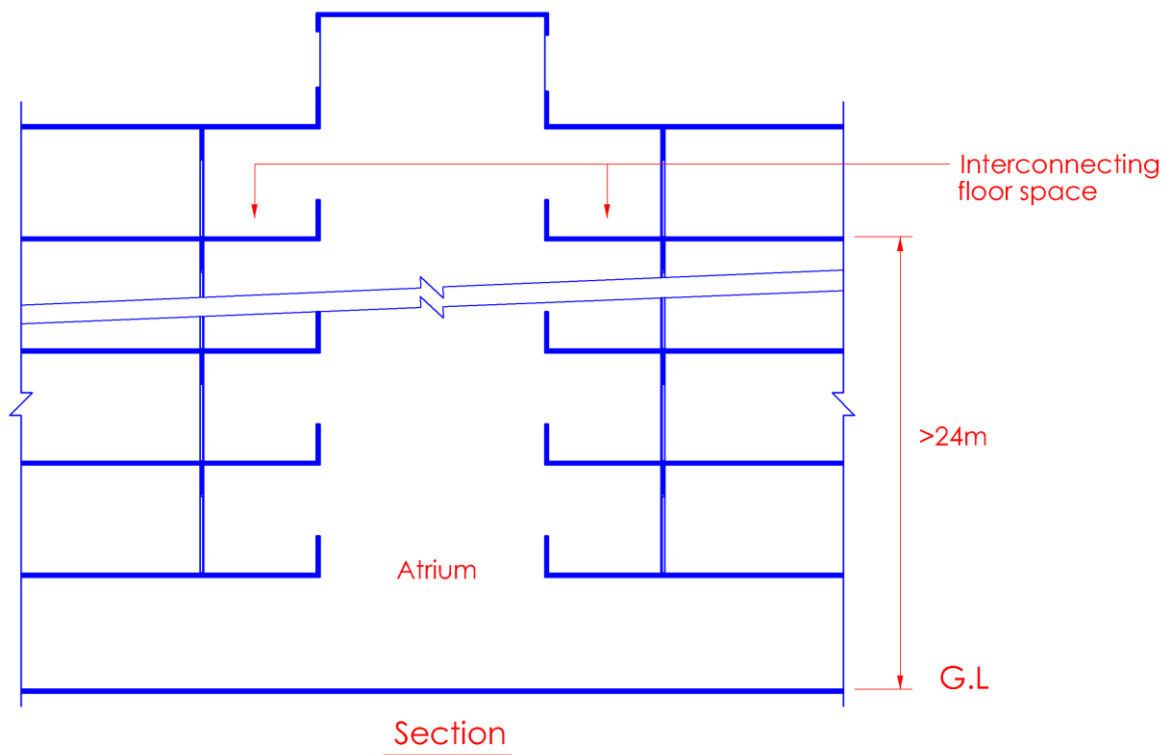

Diagram 3.2.6-2

*Atrium design allows multiple floors to be connected beyond 3 storeys per compartment but limit to a habitable height of 24m. The design would require the provision of engineered smoke control system and sprinkler system. The above clause allows atrium design in buildings, but prior approval from SCDF "FSSD" must be obtained before building plan submission can be made. See clause 1.2.5.*

# CHAPTER 3

## 3.2 PROVISION OF COMPARTMENTWALLS AND COMPARTMENT FLOORS

### 3.2.7 Buildings of High Hazard Occupancy

#### Buildings of High Hazard Occupancy

- (a) The compartment of buildings of high hazard occupancy shall not exceed one half of the sizes given in Table 3.2A and each compartment shall comprise one storey only; and
- (b) No storey of a building, the habitable height of which is more than 24m, shall be used for the bulk storage of goods or substances of highly combustible nature unless the building is provided with a sprinkler system to comply with Chapter 6; and
- (c) The type of storage materials or substances shall not include the following:
  - (i) materials that will flame up by themselves without the presence of any fire source below the ignition temperature of 200°C; and
  - (ii) combustible/highly flammable materials which include those highlighted in sub-clauses (a), (b), (c) and (d) of Cl.1.2.39.

### EXPLANATIONS & ILLUSTRATIONS

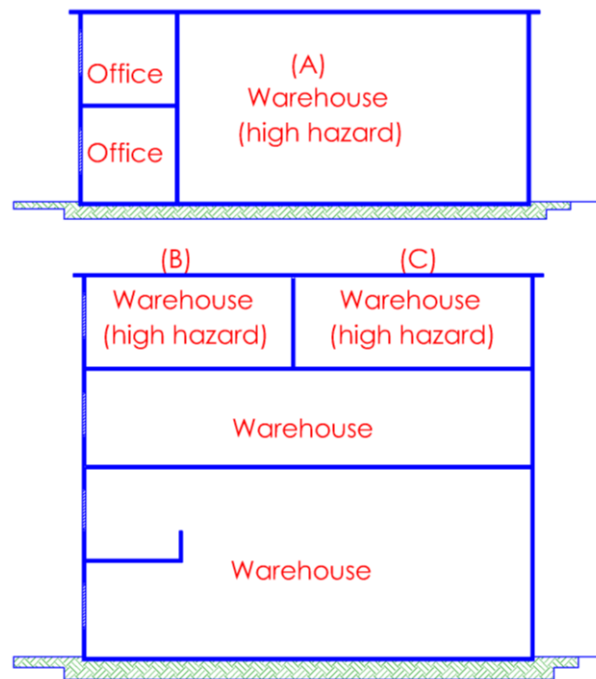

Diagram 3.2.7

- a) *Warehouse compartments A, B & C, as shown in diagram 3.2.7, shall not exceed 2000m<sup>2</sup> and 7500m<sup>3</sup>. Each compartment shall comprise one storey only. The materials to be stored in the warehouses shall exclude those listed under sub-clause c(i) & (ii).*
- b) *Buildings with habitable height not exceeding 24m are allowed to be used for bulk storage of goods or substances of highly combustible nature, except those listed under sub-clause c(i) & (ii). However, if the above mentioned warehouse buildings exceed the habitable height of 24m, the whole building must be protected with automatic sprinkler system. Irrespective of the building height, sub-clause (a) shall be complied with.*
- c) *Materials as listed under sub-clause c(i) & (ii) are not allowed to be stored in any multi-storey building, irrespective of the habitable height.*

# CHAPTER 3

## 3.2 PROVISION OF COMPARTMENTWALLS AND COMPARTMENT FLOORS

### 3.2.8 Exemption from Cl. 3.2.1 on size limitation of compartment

The requirements of Cl.3.2.1 may be exempted under the following circumstances:

- (a) Buildings used solely for the sale, storage, processing and packaging of goods and substances of a non-combustible nature, provided that any other parts of the buildings used otherwise as described shall be separated by compartment walls and compartment floors in compliance with the requirements of the relevant provisions for compartment walls and compartment floors, and
- (b) Single storey buildings of Purpose Group VI, provided that the buildings are used solely for the sale, storage, processing & packaging of goods & substances of a non-combustible nature, and
- (c) (i) Open sided car parking decks having not less than 50% of the sides permanently open and unobstructed, and such openings being evenly distributed along each of the perimeter walls and on every individual floor/deck, excluding perimeter walls to air-well, so as to provide cross ventilation to all parts of the car parking decks; and  
  
(ii) No part of the floor space shall be more than 12m from the openings on the perimeter walls of the building or air-well. Air-well where provided for this purpose shall have a superficial plan area of not less than 10 sq m, or 0.1 sq m for every 300mm of height, whichever is greater, and have a minimum dimension on plan of 2000mm, open vertically to the sky for its full height.

### EXPLANATIONS & ILLUSTRATIONS

(a) & (b) *No illustration.*

*For buildings or parts of building used for sale, storage, processing and packaging of goods and substances of a non-combustible nature, there is no specific limit of cubical extent or floor area. Each case will be considered on its merit, having regard to fire engine accessibility provided to the site and the risk to adjacent buildings. Prior approval from SCDF (FSSD) shall be obtained before building plan submission. Any portion of the building that is used otherwise than as described above should be separated from the remainder part of the building by floors, walls and protected exit staircases having the necessary fire resistance rating as the elements of structure of the building; and having the floor area and cubical extent complying with Table 3.2A.*

*A typical standalone multi storey car park having good cross ventilation and meeting the above sub-clause (c) of having not less than 50% of the sides permanently open*

### Open-sided multi-storey car park

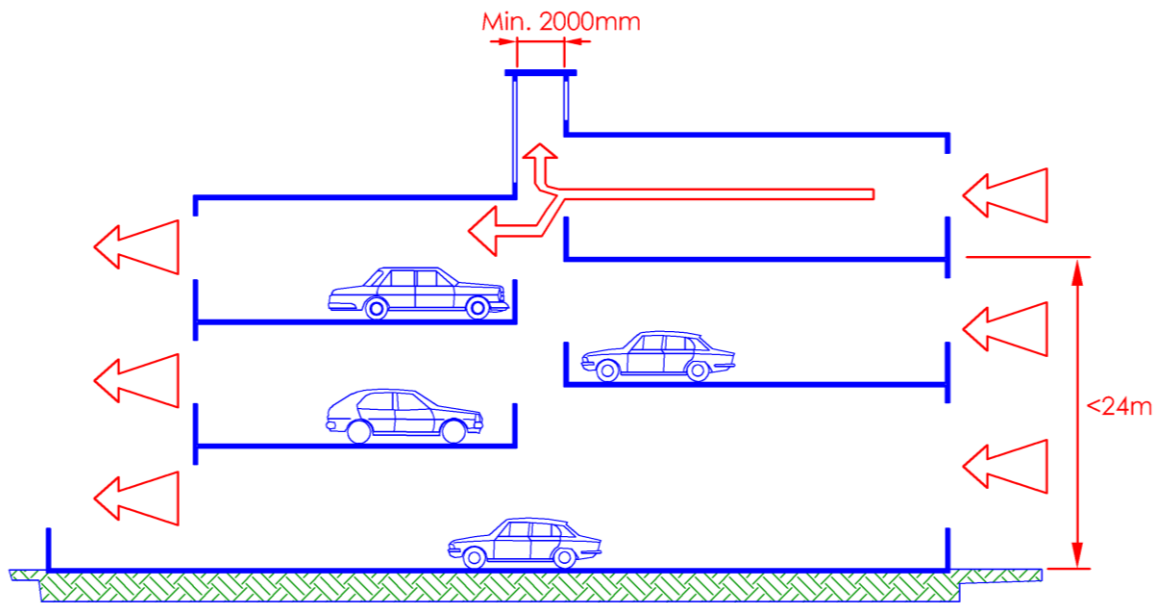

### Section

Diagram 3.2.8-1

*Size limitation of the car parking floors is exempted*

*As the habitable height is less than 24m, automatic sprinkler system is not required. The clear width of the airwell shall not be less than 2000mm to prevent fire from a car from spreading vertically between split levels. Provision of fire alarm system shall be in accordance with Table 6.4A of the Fire Code.*

*Openings such as grille, fixed louvre types are considered acceptable. In determining the openings for the grille, obstacle should be deducted to obtain the nett openings. As for fixed louvres, only free area should be taking into account. Provision of sliding windows is not acceptable. The minimum 50% openings in the external walls shall be permanently open and such openings shall be evenly distributed to provide cross ventilation so as to prevent smoke logging.*

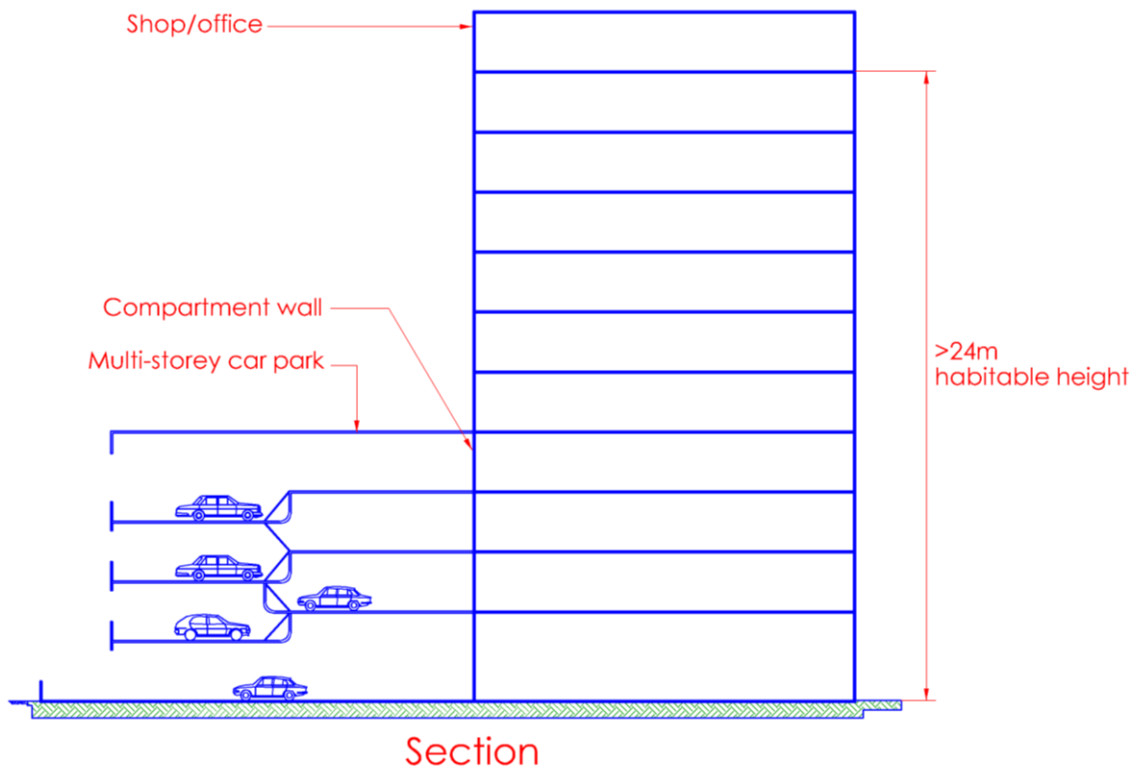

Diagram 3.2.8-2

**Situation 1 – Car park is integrated with office/shop building**

The attached multi-storey car park is required to be protected by sprinkler system. Sub-clause (c) would not apply as there is free access between car park area and the shop/office floor area. There could be sharing of common escape staircases by occupants in the car park area and the shop/office floor area.

**Situation 2 – Attached multi-storey car park is an independent building**

Attached multi-storey car park would qualify for exemption on size limitation of compartment under sub-clause (c), provided there is no access opening in the continuous vertical compartment wall that separates car park building from shop/office building and no sharing of escape staircases. Each building is self-sufficient in its provision of means of escape. Multi-storey car park shall comply fully with sub-clause (c) on the provision of permanent ventilation openings for cross-ventilation.



# CHAPTER 3

## 3.2 PROVISION OF COMPARTMENTWALLS AND COMPARTMENT FLOORS

### 3.2.9

For additions and alterations to existing buildings, the areas undergoing such works must be separated from other occupied areas of the building in accordance with clause 3.15.15.

### EXPLANATIONS & ILLUSTRATIONS

*No illustration.*

*For the benefit of clarification, the Code has introduced this new clause to clarify that the separation material for spaces undergoing additions and other occupied spaces need not be fire rated construction. Instead, non-combustible partition used for separation between the undergoing A&A works and other occupied areas shall suffice.*

# CHAPTER 3

## 3.3 FIRE RESISTANCE OF ELEMENTS OF STRUCTURE

### 3.3.1 Minimum periods of fire resistance

Subject to any expressed provision to the contrary, any element of structure shall be constructed of non-combustible materials and to have fire resistance for not less than the relevant period specified in Table 3.3A having regard to the purpose group of the building of which it forms a part and the dimensions specified in that Table, provided that –

- (a) Any separating wall shall have fire resistance of not less than 1-hour, and
- (b) Any compartment wall or compartment floor which separates a part of a building falling within purpose group II or III from any other part of the building falling within a purpose group other than purpose group II or III shall have fire resistance of not less than 1-hour

### EXPLANATIONS & ILLUSTRATIONS

*Single storey residential building as provided for under Table 3.3A needs to have minimum half-hour fire resistance rating for all elements of structure irrespective of the floor area. All elements of structure shall be constructed of non-combustible materials unless otherwise permitted as in the construction of attic.*

*Houses not more than 3-storey*

*Table 3.3A Part 1 provides for residential building. Residential buildings having not more than 3 storeys or levels, including basement or attic, shall be provided with minimum period of fire resistance rating of half-hour for all elements of structure forming the ground or upper storey and 1-hour for the basement storey. If the basement storey has a floor area not exceeding 50m<sup>2</sup>, the period of fire resistance rating for the elements of structure can be reduced to half-hour.*

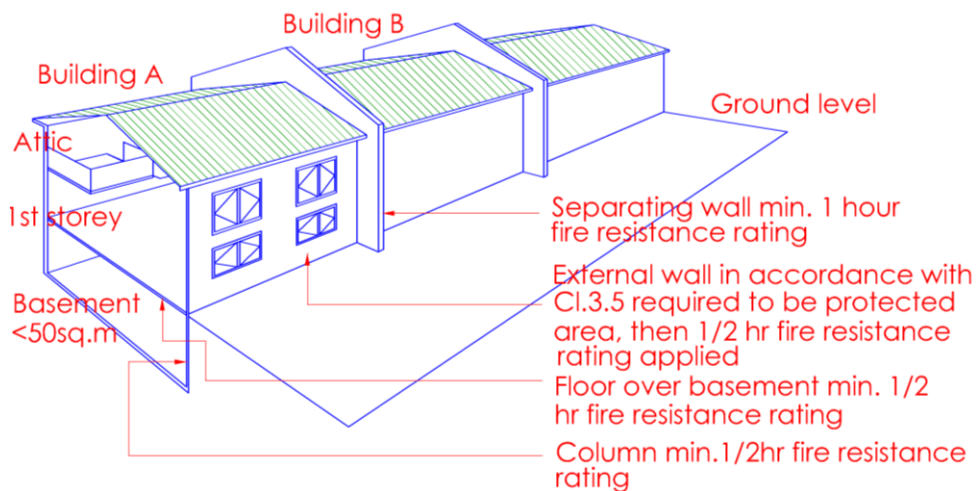

Fire resistance to columns, beams, floors and external wall

Diagram 3.3.1

*Footnote (a) to Table 3.3A allows the period to be half an hour for elements forming part of a basement storey which has an area not exceeding 50 sq.m to houses having not more three storey.*

*Houses having 4 storeys*

*For buildings in which each storey does not exceed 250m<sup>2</sup>, the minimum period of fire resistance rating for elements of structure forming part of:*

- a. a ground storey or upper storey - 1 hour (this period can be reduced to half-hour for floor which is not a compartment floor, except the beams which support the floor or any part of the floor which contribute to the structural support of the building as a whole).*
- b. Basement storey - 1 hour.*

*Where the floor of each storey in the building exceeds 250m<sup>2</sup>, all the elements of structure for basement and above ground shall have min. 1 ½ hour and 1 hour fire resistance rating respectively.*

**EXPLANATIONS & ILLUSTRATIONS**

**3.3.1**

*Any element of structure shall be so constructed as to have fire resistance for not less than the relevant period specified in Table 3.3A.*

*“Notes to Part I”, below the Table 3.3A, summarises how the Table is applied in determining the required period of fire resistance for a building under Purpose Group II. The ‘lines’ mentioned refers to the categories or subgroups of buildings under the same Purpose Group as shown below:*

Purpose Group	MAXIMUM DIMENSIONS			Minimum period of fire resistance (in hours) for elements of structure (*) forming part of-	
	Height (in m)	Floor area (in m <sup>2</sup> )	Cubical Extent (in m <sup>3</sup> )	Ground storey or upper storey	Basement storey
(1)	(2)	(3)	(4)	(5)	(6)
<i>Buildings under Purpose Group II</i>					
<b>Line 1</b> <i>Building or part (+) having not more than two storeys</i> ..	NL	500	NL	½	1
<b>Line 2</b> <i>Building or part (+) having three storeys</i> .. .. ..	NL	250	NL	1 (b)	1
<b>Line 3</b> <i>Building having any number of storeys</i> .. .. ..	28	3,000	8,500	1	1 ½
<b>Line 4</b> <i>Building having any number of storeys</i>	NL	2,000	5,500	1 ½	2

*Three 3-storey buildings with the following configurations are used as examples to explain how their periods of fire resistance can be determined.*

<b>Building configurations</b>	<b>Height (m)</b>	<b>Floor area (m<sup>2</sup>)</b>	<b>Cubicle extent (m<sup>3</sup>)</b>
<i>Building A</i>	<28	240	960
<i>Building B</i>	<28	2900	8450
<i>Building C</i>	<28	1900	5400

**Example 1 (Building A)**

With reference to the Table 3.3A, Part I, the floor area and cubical extents of building A can satisfy the limitations or configurations of lines 2, 3 & 4 of the Table. However, under the 'Notes to Part I', "topmost of those lines" should apply. Hence, the period of fire resistance should be as specified in column (5) and (6) of line 2.

**Example 2 (Building B)**

Line 2 of the Table 3.3A Part I would not be applicable since the floor area of building B exceeds 250m<sup>2</sup>. Similarly, line 4 is not applicable as its floor area and cubical extent exceeds 2000m<sup>2</sup> and 5500m<sup>3</sup> respectively. Thus, since only line 3 is applicable, the period of fire resistance for building B should be as in column (5) and (6) of line 3.

**Example 3 (Building C)**

Line 3 and 4 of the Table would be applicable to building C, but, under 'Notes to Part I', "topmost of those lines" should apply. Hence, the period of its fire resistance should be that of column (5) and (6) of line 3.

It should be noted here that, if the overall height of the building exceeds 28m, then the conditions/limitations of line 4 must be complied with, unless otherwise waived by the relevant Authority or provision of automatic sprinkler system is provided to cover the entire building.

*Building not more than 2 storeys (e.g basement & 1<sup>st</sup> storey)*

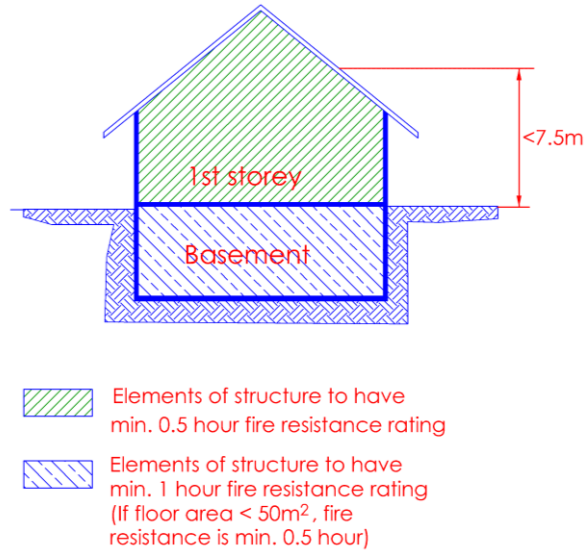

*Diagram 3.3A-1*

*With reference to Table 3.3A, Part I, if the maximum floor area of a storey of a 2 storey building shown above, is less than 500m<sup>2</sup>, then the fire resistance rating stipulated in columns (5) and (6) of line 1 of the Table 3.3A Part 1 need only be applied. That is, elements of structure above ground level shall have a minimum fire resistance rating of 0.5 hour, and that of the basement, minimum 1-hour fire resistance rating is required.*

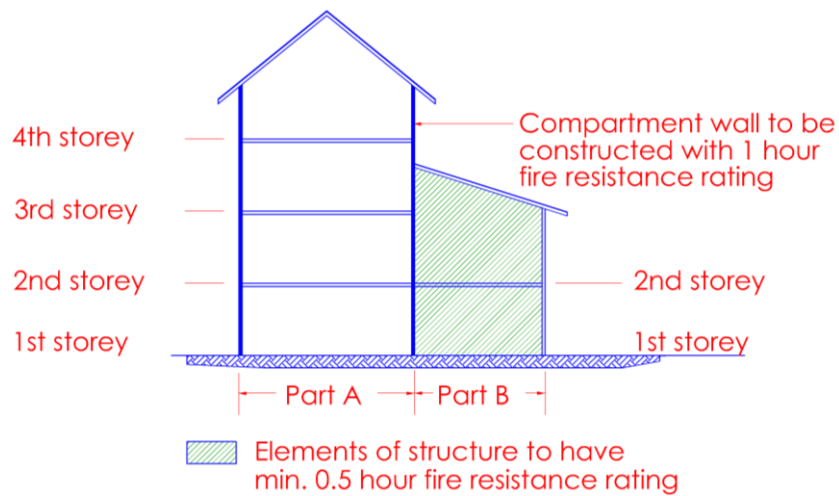

*Diagram 3.3A-2*

*If the maximum floor area of each compartment does not exceed 500m<sup>2</sup>, then building Part B shall comply with column (5) line 1 of Table 3.3A Part I, while building Part A shall comply with the requirements of line 3. It shall also be noted here that the compartment wall separating the two parts, A and B of the building, shall comply with the minimum fire resistance rating as required for the higher part*

*(Part A) of the building. This means that the fire resistance rating of column (5) line 3 of Table 3.3A Part I shall be applied to the compartment wall separating Part A and B of the building.*

*Building of 3 storeys*

Figure (ii)

Diagram 3.3A-3

- (1) As a relaxation to the requirements of Table 3.3A Part I, the floor of the attic of a 2-storey (inclusive of basement) plus attic building can be reduced to half hour fire resistance rating, as it is not a compartment floor. This is allowed on condition that the attic floor slab does not contribute to the support of the building as a whole, in the form of transfer beam.
- (2) Under item (b) of "Notes to Part I" below Table 3.3A Part I, the beams and columns supporting the attic floor shall be constructed to have the same fire resistance rating required of the building. Hence, the beams and columns supporting the attic floor in figure (ii) of above diagram 3.3(A) – 3 shall have 1 hour fire resistance rating.
- (3) Items (1) & (2) above shall only be applicable if the maximum floor area of each compartment of the building does not exceed 250m<sup>2</sup>, in which case, as a relaxation, the fire resistance ratings stipulated in line 2 of Table 3.3A Part I may be applied to the elements of structure of the above 2-storey plus basement building. (Figure (i) and (iii) of diagram 3.3A – 3)
- (4) However, if the floor area of compartment of a 3 storey building or part having 3 storey as shown in figure (I) and (iii) exceeds 250m<sup>2</sup>, the requirements of lines 3 or 4 of Table 3.3A Part I shall be applied accordingly, and the relaxation allowed for non-compartment floors under items (1) & (2) above will not apply.

*Building exceeding 3 storeys but not exceeding building height 28m*

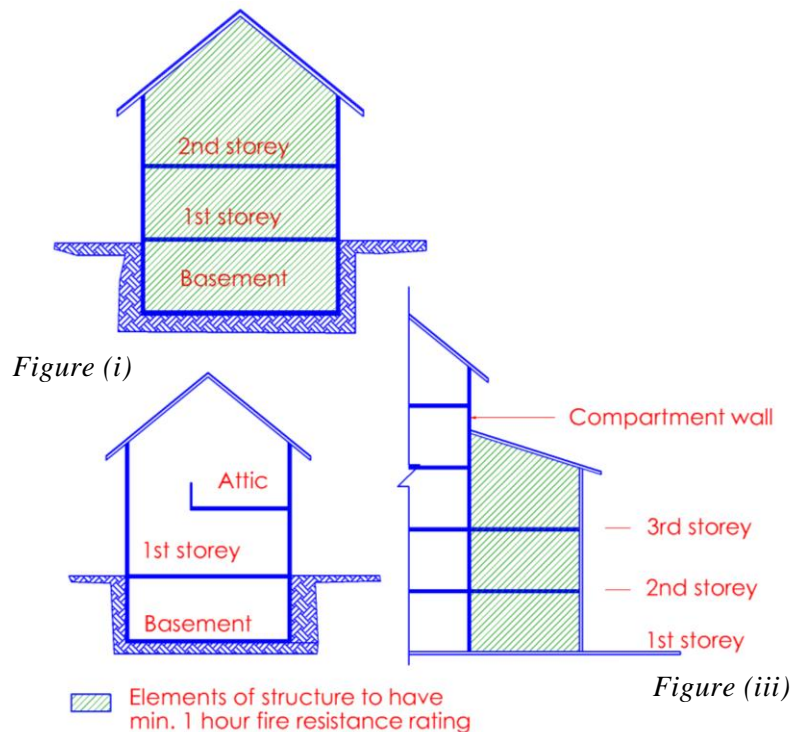
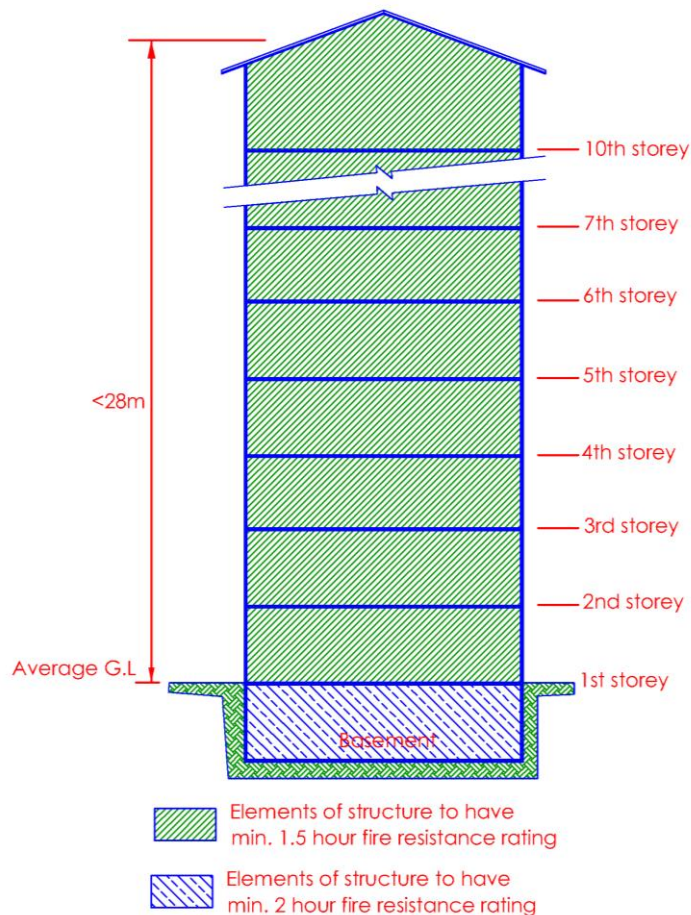
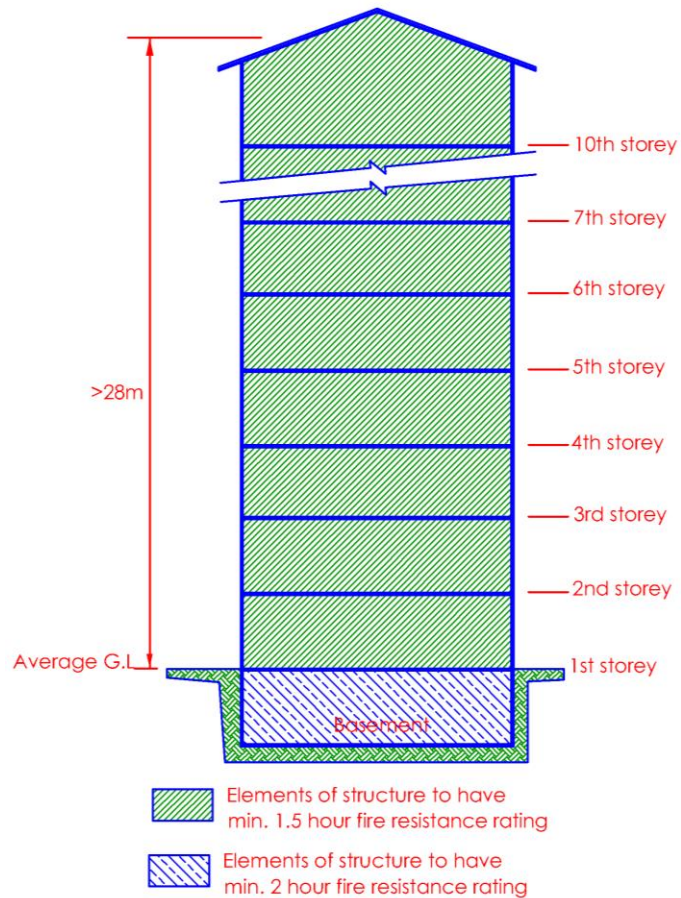

*Diagram 3.3A-4*

*The period of fire resistance rating specified in the above diagram for a building not exceeding building height 28m is based on columns (5) and (6) of line 3 of Table 3.3A Part I, provided the floor area and cubical extent of each compartment shall not exceed  $3000\text{m}^2$  and  $8500\text{m}^3$  respectively.*



*Building exceeding 28m*



*Diagram 3.3A-5*

*With reference to line 4 of Table 3.3A Part I, the maximum floor area and cubical extent of each compartment of a building of Purpose Group II, exceeding the building height of 28m shall not exceed 2000m<sup>2</sup> and 5500m<sup>3</sup> respectively, unless otherwise waived by the Relevant Authority or automatic sprinkler system is provided to cover the whole building.*

TABLE 3.3A – continued

*(Minimum periods of fire resistance)*PART 2 – SINGLE STOREY BUILDINGS

<i>Purpose Group</i>	<i>Maximum floor area (in m<sup>2</sup>)</i>	<i>Minimum period of fire resistance (in hours)for elements of structure</i>
<i>(1)</i>	<i>(2)</i>	<i>(3)</i>
<i>II (Other residential)</i>	<i>3,000</i>	<i>½</i>

*Notes to Part 2*

*For the purpose of Cl.3.3.1 the period of fire resistance to be taken as being relevant to an element of structure is the period included in column (3) in the line of entries which specifies the floor the area with which there is conformity or, if there are two or more such lines, in the topmost of those lines.*

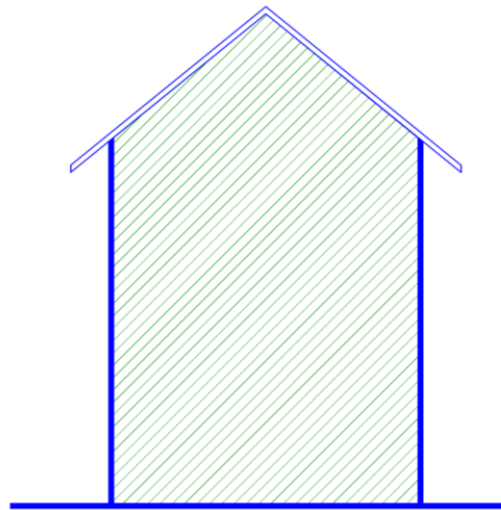

 Elements of structure to have min. 1/2 hour fire resistance rating

*The floor area of each compartment shall not exceed 3000m<sup>2</sup>, however, it is not common to have single storey buildings under Purpose Group II.*

*Diagram 3.3.1(b)-1*

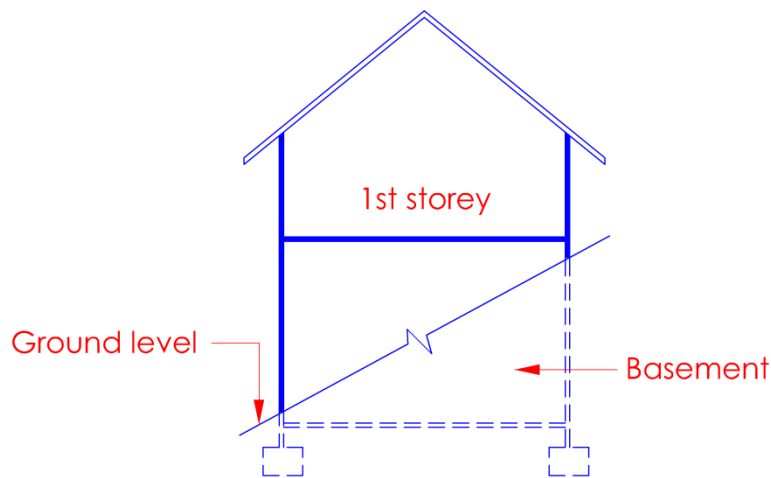

*Diagram*

*3.3.1(b)-2*

*If the building has a basement, it is not a single-storey building for the purpose of working out the fire resistance rating for the elements of structure.*

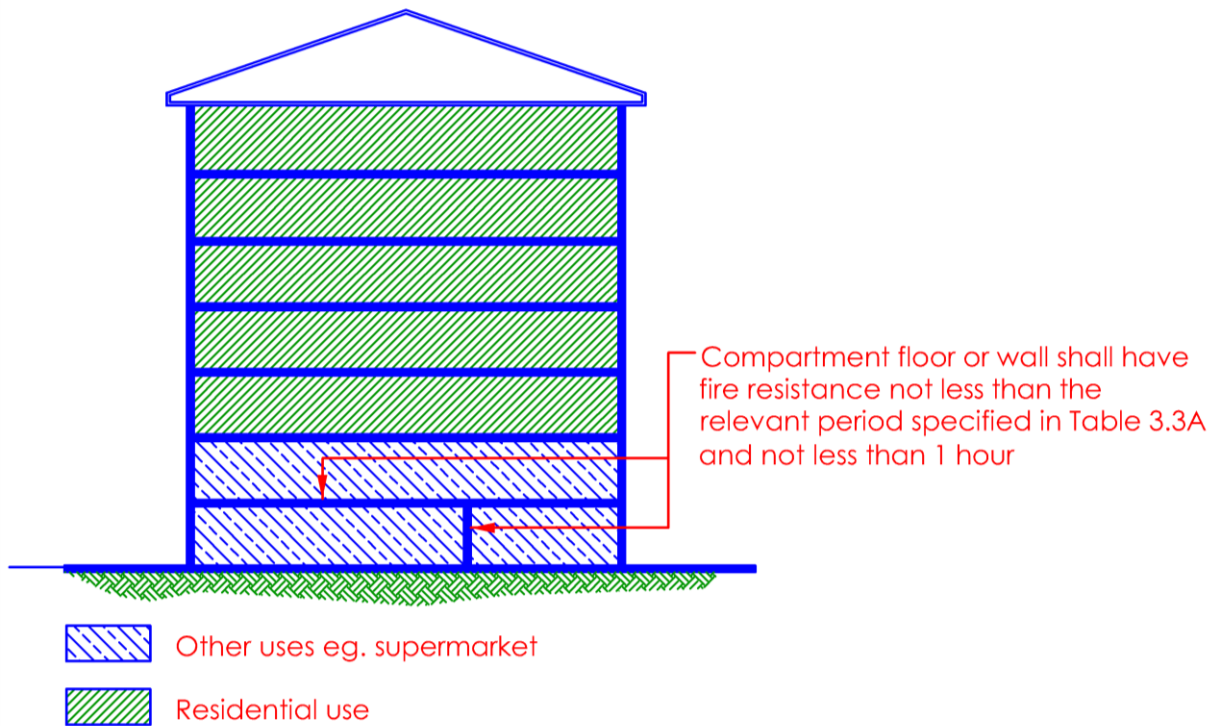

Diagram 3.3.1(b)-3

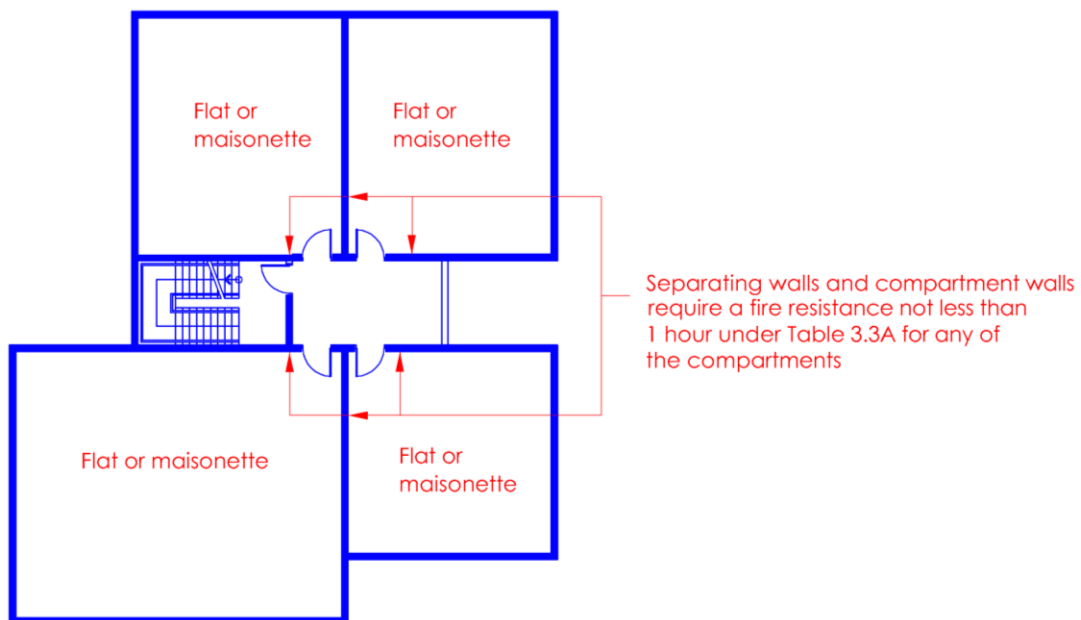

Diagram 3.3.1(b)-4

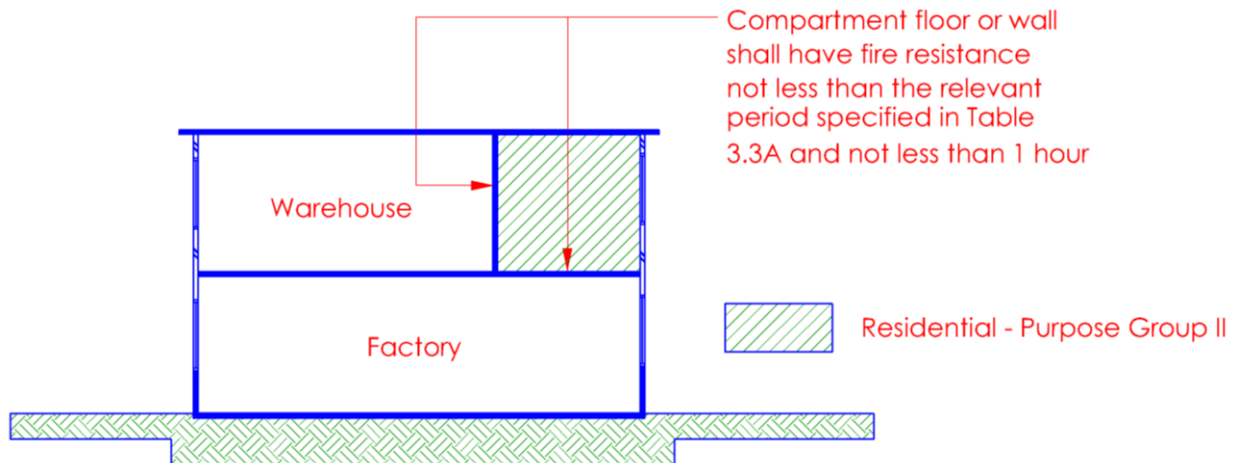
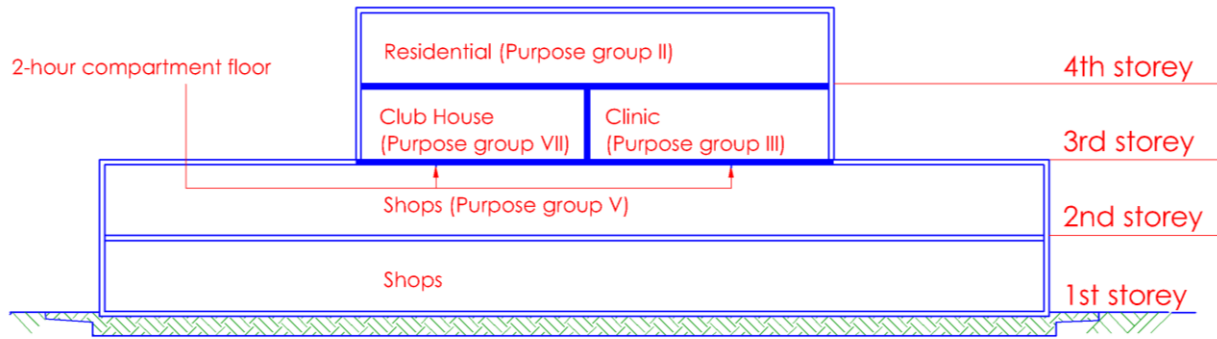

Diagram 3.3.1(b)-5

*The main intention of the above sub-clause is to spell out the min. period of fire resistance rating for separating wall i.e. 1-hour although the period specified in Table 3.3A could be ½-hour for elements of structure for small and low-rise buildings under Purpose groups (IV), (v) and (VII). If the period of fire resistance specified in Table 3.3A is more than 1-hour for elements of structure, then this period shall be made applicable to the separating wall.*



## Section

*Diagram 3.3.1(b)-6*

### ***Fire resistance of compartment floors***

- (i) *The compartment floor between residential (purpose group II) and club house (purpose group VII) shall have min. 1-hour fire resistance rating.*
- (ii) *The compartment floor between clinic (purpose group III) and shops below (purpose group V) shall have min. 1-hour fire resistance rating.*
- (iii) *The compartment floor between club house/clinic and shops below shall have min. 1-hour fire rating. If the shops require 2-hour fire resistance rating, then this rating shall apply to the compartment floor.*

### ***Fire resistance of compartment wall***

*The compartment wall that separates club house from clinic shall have fire resistance of not less than the relevant period specified in Table 3.3A, but shall not be less than 1-hour.*

# CHAPTER 3

## 3.3 FIRE RESISTANCE OF ELEMENTS OF STRUCTURE

### 3.3.2 Exemption for non-loadbearing external walls

Requirement on fire resistance in Cl.3.3.1 shall not apply to :

- (a) any part of any external wall which is non-loadbearing and can, in accordance with Cl. 3.5 be an unprotected area.
- (b) steel structures for standalone carpark if the following conditions are fulfilled :
  - (i) Each storey shall be provided with cross-ventilation by the provision of uninterrupted openings evenly distributed around the perimeter walls, excluding perimeter walls to airwell. The area of the openings shall not be less than 50% of all external walls or 15% of the footprint per storey, whichever is greater. This condition is not applicable if sprinkler system is installed throughout the carpark; and
  - (ii) No point on any storey shall be more than 12m from external air or air-well. Air-well where provided for this purpose shall have a superficial plan area of not less than 10m<sup>2</sup>, or 0.1m<sup>2</sup> for every 300mm of height, whichever is greater, and have a minimum dimension on plan of 2000mm, open vertically to the sky for its full height. This condition is not applicable if sprinkler system is installed throughout the carpark; and
  - (iii) All floor beams shall be designed as a composite structure with the floor slab; and
  - (iv) Building is not more than 24m in habitable height. There shall not be any basement storey; and
  - (v) No other usages, other than the electrical services that serve only the car park, are permitted; and
  - (vi) Steel structures shall meet the specifications of BS 5950 Pt 8; and
  - (vii) These requirements are for carpark for passenger vehicles of Class 3 and below.

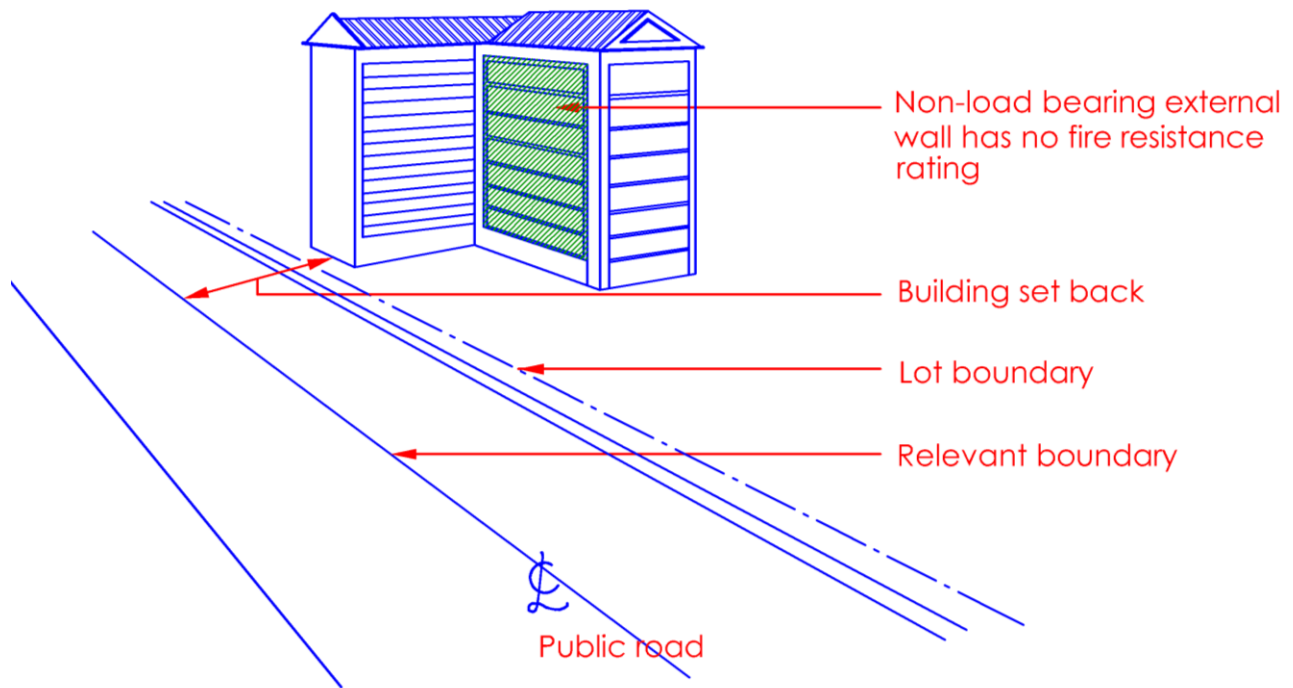

Diagram 3.3.2

*Any part of a non-load bearing external wall which constitute the unprotected opening in pursuance to clause 3.5, is not required to have any fire resistance. In the above diagram, the non-load bearing external wall facing the public road need not have fire resistance as it meets Cl.3.5 on set-back requirement, measured from the centre of the public road to the external wall.*



# CHAPTER 3

## 3.3 FIRE RESISTANCE OF ELEMENTS OF STRUCTURE

### 3.3.3 Exemption for single storey buildings

In the case of a single storey building or a building consisting of a first storey and one or more basement storeys, requirement on fire resistance in Cl.3.3.1 shall not apply to any element of structure which forms part of the first storey and consists of :

- (a) A structural frame or a beam or column, provided that any beam or column (whether or not it forms part of a structural frame) which is within or forms part of a wall, and any column which gives support to a wall or gallery, shall have fire resistance of not less than the minimum period, if any, required by this code for that wall or gallery, or

### EXPLANATIONS & ILLUSTRATIONS

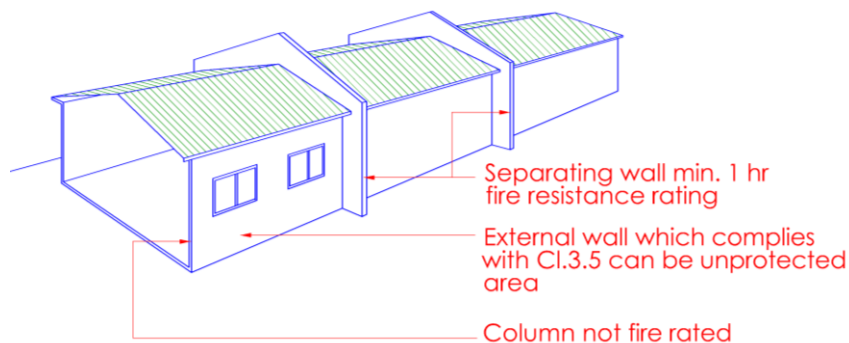

Diagram 3.3.3

#### Single storey building with or without basement

#### Exemption for Single Storey Buildings

Irrespective of floor area, the minimum period of fire resistance rating for elements of structures is half-hour. However, clause 3.3.3 of the current Fire Code provides exemption for single storey buildings which need not comply with half-hour fire resistance rating for the structural frame or beam or column subject to:

- a. the beams or columns are not supporting a wall or gallery;
- b. the beams or columns are not forming part of the separating wall between houses;
- c. the external walls including the supporting beams or columns which are not supporting a gallery or in accordance with cl.3.5 be an unprotected area.

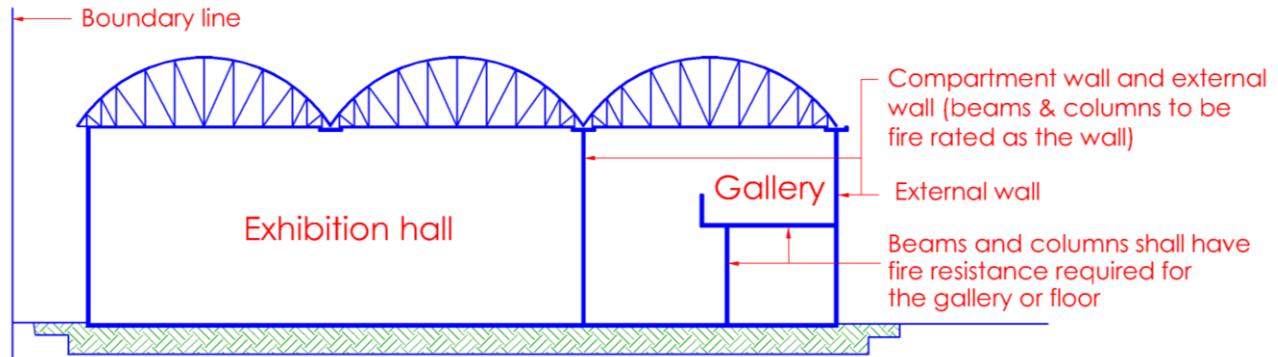

Diagram 3.3.3(a)

The above exemption applies to all single storey buildings. However, in cases where the floor area of the building exceeds 3800m<sup>2</sup>, prior consultation with SCDF (FSSD) is required.

- (i) The structural frame or beams and columns of a single storey building need not have fire resistance under Table 3.3A, unless otherwise specified by the Relevant Authority. The qualified persons shall, before making building plan submission, consult SCDF (FSSD) as to the need for protection of beams and columns in the following situations :
  - a) Single storey factory or warehouse involving high hazard materials;
  - b) Single storey factory or warehouse having an extensive footprint; and
  - c) Single storey warehouse exceeding a building height of 10m.
- (i) However, any beam or column which is within or forms part of a compartment wall, separating wall or external wall (which requires fire resistance under clause 3.5) shall be required to have the same fire resistance rating as the wall in which such beam or column forms part of.
- (ii) Any column or beam which gives support to a wall or gallery, shall have the same fire resistance as that required for the wall or gallery, e.g. column and beam supporting the external wall or mezzanine floor shall have the necessary fire resistance rating.

(b) An internal loadbearing wall or a loadbearing part of a wall, unless that wall or part of it forms part of a compartment wall or a separating wall, or forms part of the structure enclosing a protected shaft or supports a gallery, or

## EXPLANATIONS & ILLUSTRATIONS

### 3.3.3 (b)

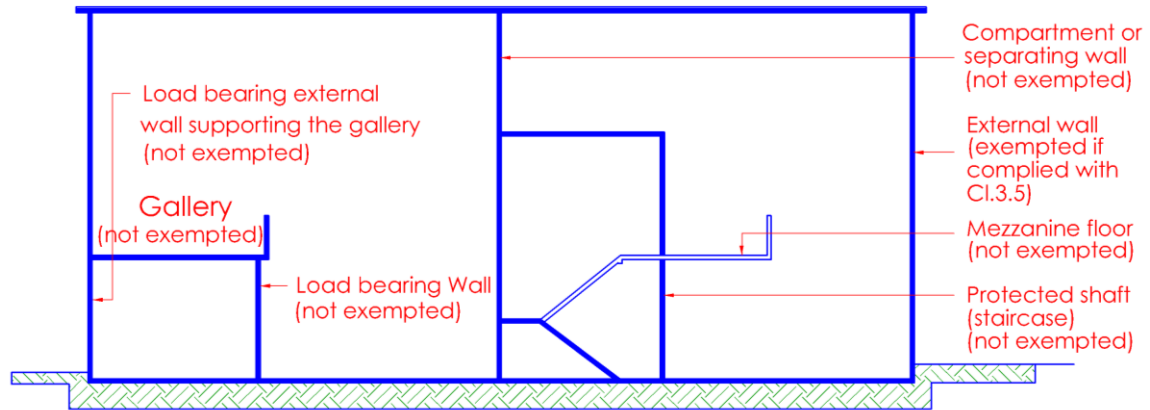

Diagram 3.3.3(b)

An internal loadbearing wall or a loadbearing part of a wall is not required to have fire resistance under Table 3.3A, provided the wall is not –

- i) forming part of or a compartment or separating wall
- ii) forming part of the structure enclosing a protected shaft e.g. exit staircase; or
- iii) supporting a gallery

(c) Part of an external wall which does not support a gallery and which may, in accordance with Cl.3.5 be an unprotected area.

**EXPLANATIONS & ILLUSTRATIONS**

**3.3.3 (c)**

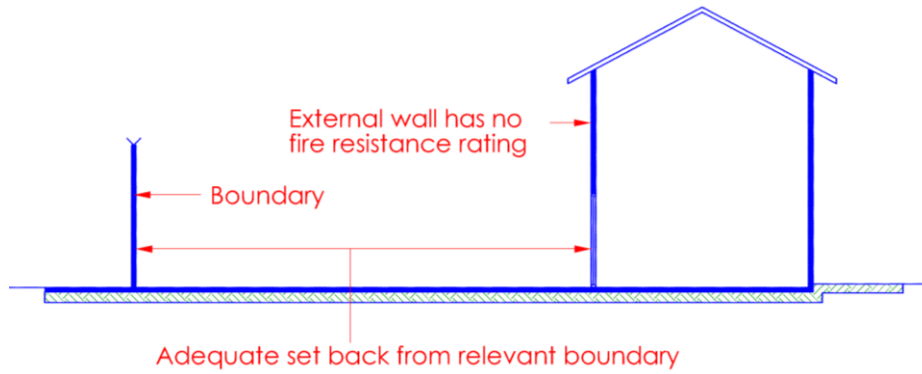

*Diagram 3.3.3(c)*

*External wall which does not support a gallery and has adequate setback from the boundary in accordance with Cl.3.5 to be an unprotected area need not have fire resistance under Table 3.3A.*

# CHAPTER 3

## 3.3 FIRE RESISTANCE OF ELEMENTS OF STRUCTURE

### 3.3.4 Interpretation and application of this regulation

The interpretation and application of Cl.3.3 shall be as follows:

- (a) Subject to the provisions of sub-cl.(b) and any other expressed provision to the contrary, any reference to a building of which an element of structure forms a part means the building or (if the building is divided into compartments) any compartment of the building of which the element forms a part, and

### EXPLANATIONS & ILLUSTRATIONS

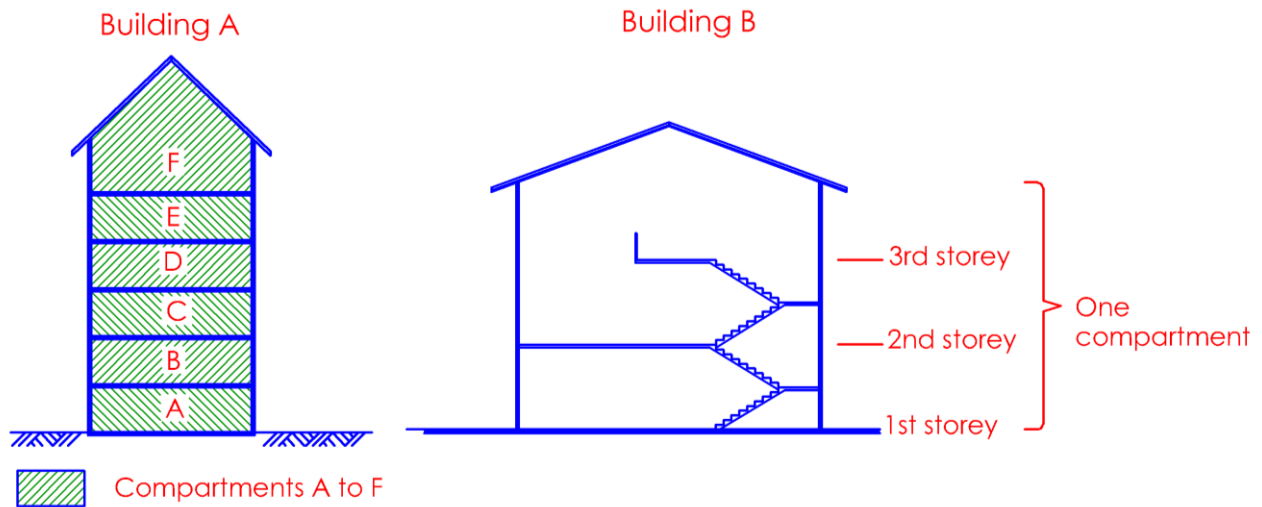

Diagram 3.3.4(a)-1

*Any reference to a building, which is divided into compartments, of which an element of structure forms a part, means that compartment of the building (Building A).*

*Any reference to a building of which an element of structure forms a part means the building (Building B). It is important to note that any element carrying another element of structure must have at least the same fire resistance as the element it is supporting.*

(b) Any reference to height means the height of a building, but if any part of the building is completely separated throughout its height both above and below ground from all other parts by a compartment wall or compartment walls in the same continuous vertical plane, any reference to height in relation to that part means the height solely of that part, and

**EXPLANATIONS & ILLUSTRATIONS**

**3.3.4 (b)**

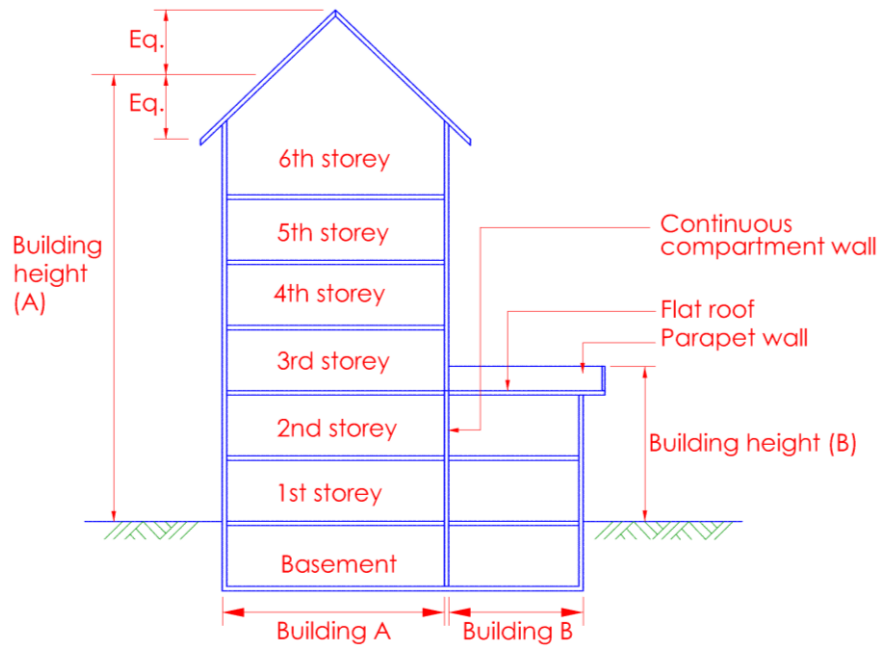

Diagram 3.3.4(b)

The continuous vertical compartment wall divides the building into 2 parts. For building A, any reference to height means the building height (A). For building B, any reference to height means the building height (B).

(c) If any element of structure forms part of more than one building or compartment and the requirements of fire resistance specified in Table 3.3A in respect of one building or compartment differ from those specified in respect of any other building or compartment of which the element forms a part, such element shall be so constructed as to comply with the greater or greatest of the requirements specified.

**EXPLANATIONS & ILLUSTRATIONS**

**3.3.4 (c)**

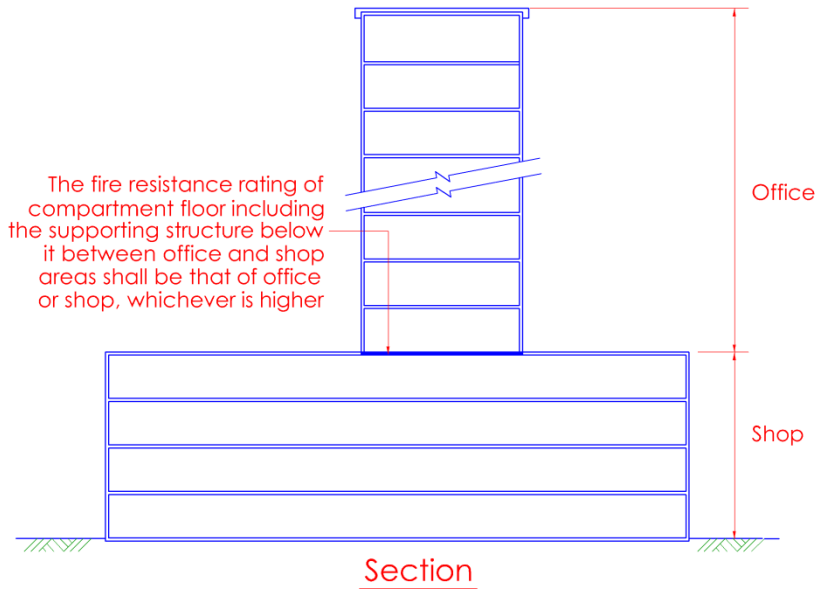

Diagram 3.3.4(c)-1

The diagram above shows a shopping podium and an office tower. The fire resistance of the elements of structure at the interface between the podium and tower shall be the higher of the two purpose groups (shops or offices).

The elements of structure referred to include compartment floor and also the columns going through the podium to support the structural frame of the office tower.

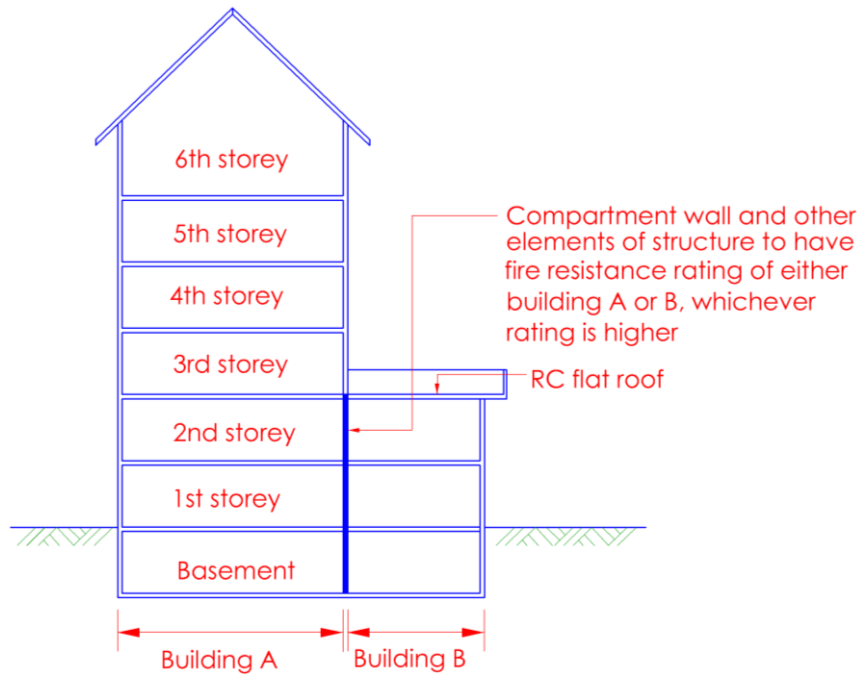

Diagram 3.3.4(c)-2

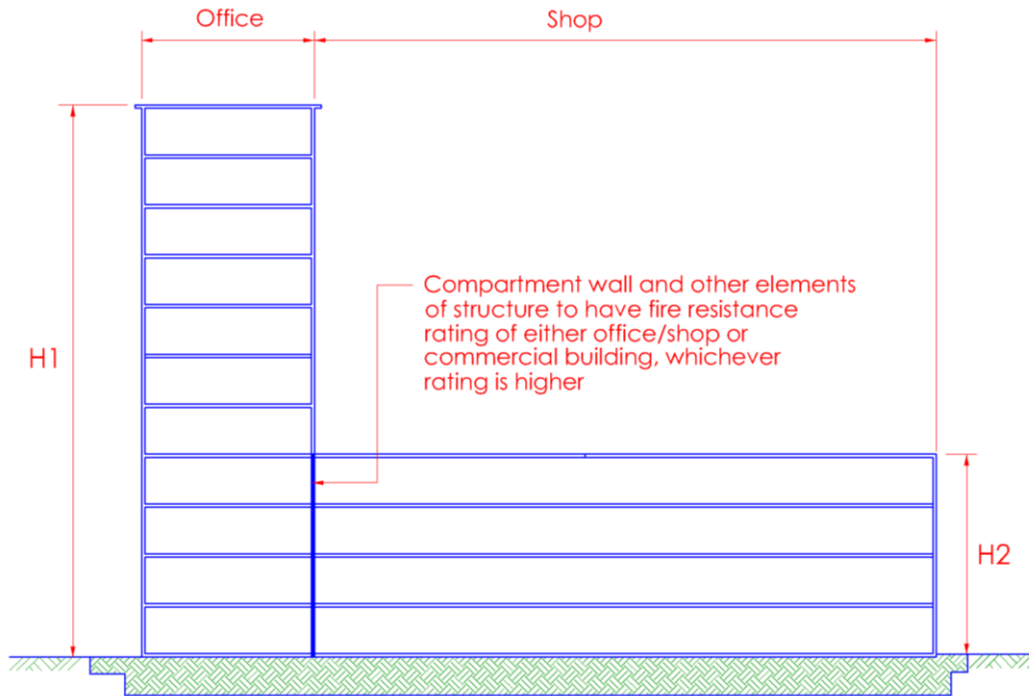

Diagram 3.3.4(c)-3

*In the above diagrams, the continuous vertical compartment wall forms part of more than one building or compartment. The compartment wall shall be constructed to have higher fire resistance rating of the two buildings or compartments.*



(d) If any element of structure is required to be of non-combustible construction, the measure of fire resistance rating shall be determined by the part which is constructed wholly of non-combustible materials. (With the exception of fire protecting suspended ceilings, surface materials for walls and ceilings and floor finishes may be combustible, if they are not relied on to contribute to the fire resistance of the wall or floor).

**EXPLANATIONS & ILLUSTRATIONS** **3.3.4 (d)**

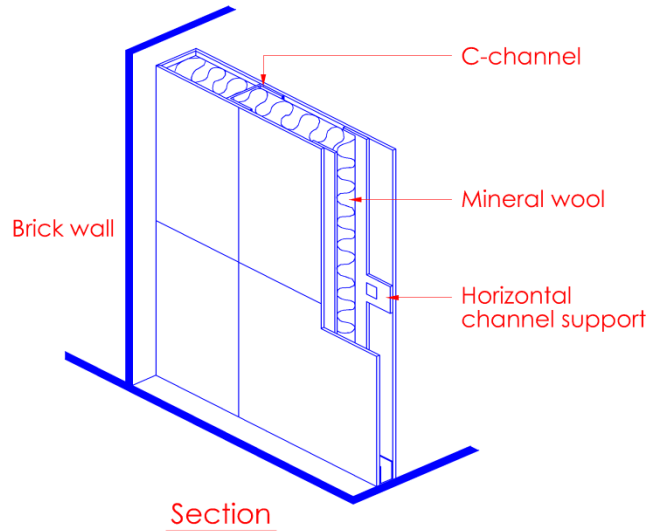

Diagram 3.3.4(d) – 1

The above diagram shows the construction of a non-load bearing fire rated compartment wall. If the C-channels or horizontal channel supports are replaced with timber members, the construction would not meet the requirement of the above subclause, as timber members are combustible. However, combustible finish if added to the surface of the wall would be considered as acceptable, provided it complies with Cl.3.13.

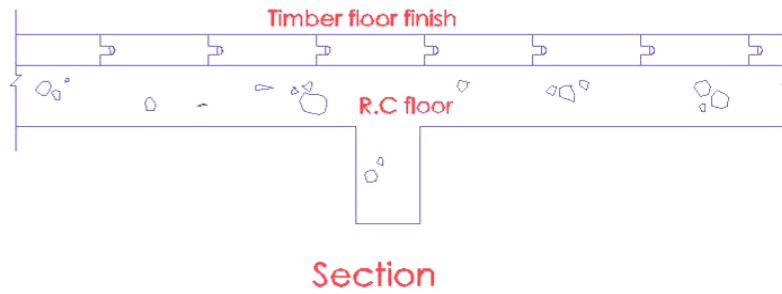

Diagram 3.3.4(d) – 2

The above diagram shows the addition of timber floor finish to the R.C floor. The combustible floor finish is not to be considered as contributing to the fire resistance of the floor.

For fire protection to suspended ceilings see cl. 3.3.6. The above clause is also not applicable to buildings under preservation or conservation where structural timber members are required to be retained. See also cl. 3.4.3.

# CHAPTER 3

## 3.3 FIRE RESISTANCE OF ELEMENTS OF STRUCTURE

### 3.3.5 Wall separating residential apartment or maisonette

Any compartment wall separating a residential apartment or maisonette from any other part of the same building, shall not be required to have fire resistance exceeding 1-hour unless –

- (a) The wall is a wall forming part of a protected shaft and the minimum period of fire resistance required by the provisions of this code for the protecting structure is more than 1-hour, or
- (b) The part of the building from which the wall separates the residential apartment or maisonette is of a different purpose group and the minimum period of fire resistance required by the provisions of this code for any element of structure in that part is more than 1-hour.

### EXPLANATIONS & ILLUSTRATIONS

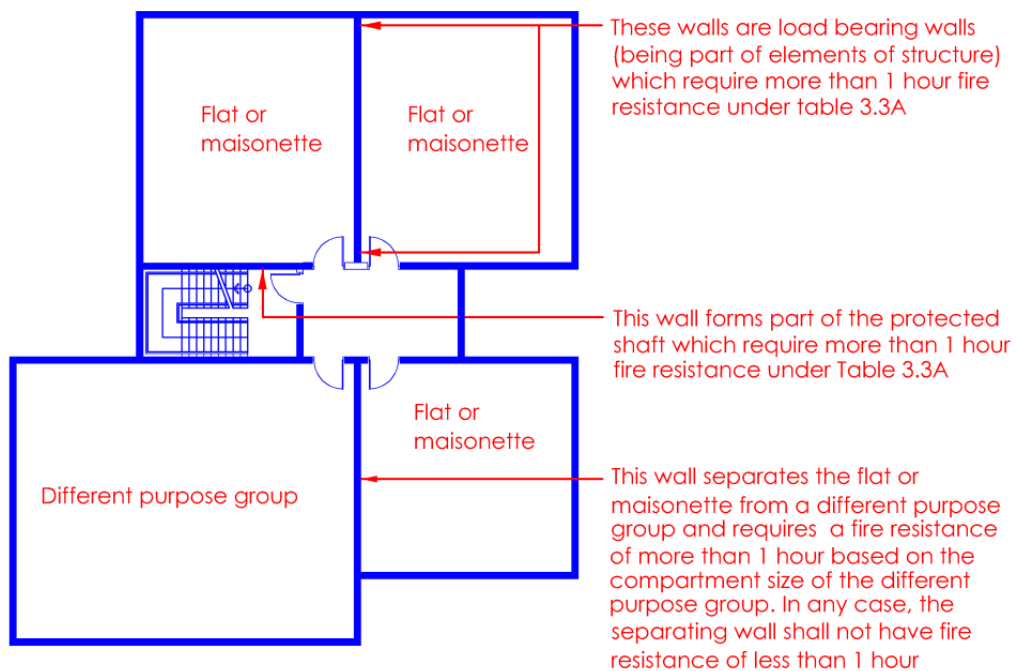

Diagram 3.3.5

# CHAPTER 3

## 3.3 FIRE RESISTANCE OF ELEMENTS OF STRUCTURE

### 3.3.6 Suspended ceiling

In determining the fire resistance of floors, no account shall be taken of any fire resistance attributable to any suspended ceiling unless the ceiling is constructed specifically as a fire protecting suspended ceiling and the construction complies with the requirements under Table 3.3B for Limitations on Fire Protecting Suspended Ceilings.

### EXPLANATIONS & ILLUSTRATIONS

3.3.6

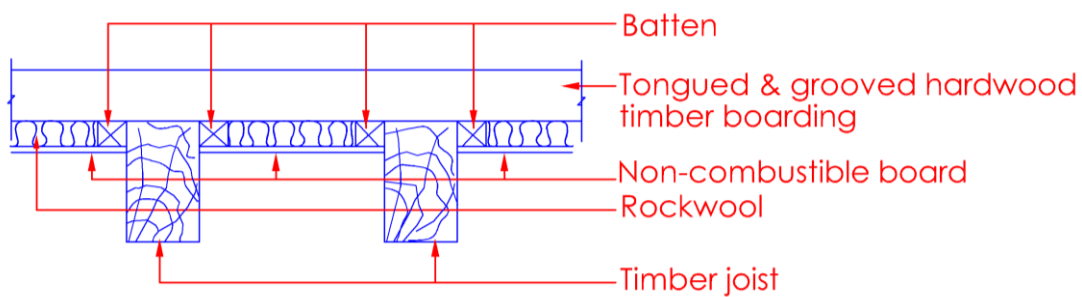

Diagram 3.3.6-1

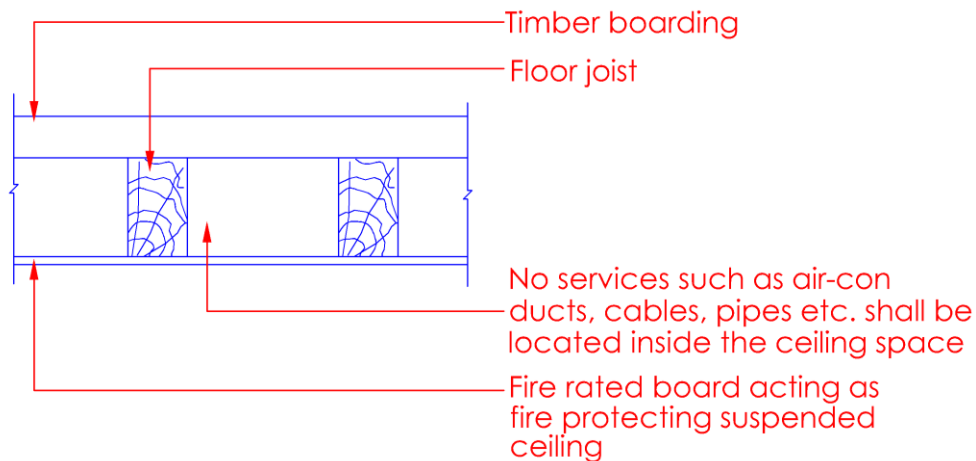
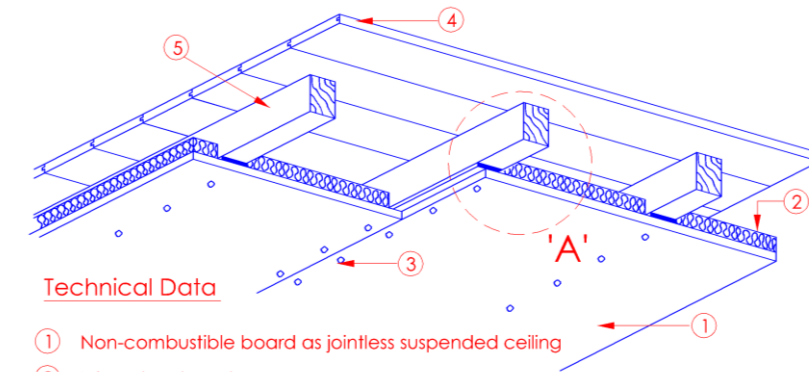

Diagram 3.3.6.2

*The suspended ceiling is to be treated as the soffit as the floor system or assembly consists of the timber boarding, joists and the suspended ceiling to achieve the necessary fire resistance rating. Therefore the concealed space in the floor system or assembly is to be treated differently from concealed spaces mentioned under Cl.3.11. The main different is that concealed spaces in floor system or assembly are not permitted to have services such as air-con ducts, cables, pipes etc; even if these services are housed in fire rated enclosures.*



#### Technical Data

- ① Non-combustible board as jointless suspended ceiling
- ② Mineral rockwool
- ③ Self-tapping screws spaced at 200mm intervals
- ④ T & G timber flooring boards (minimum 16mm thick)
- ⑤ Hard wood timber joists

Floor assembly to satisfy BS 476 for required Fire-rating

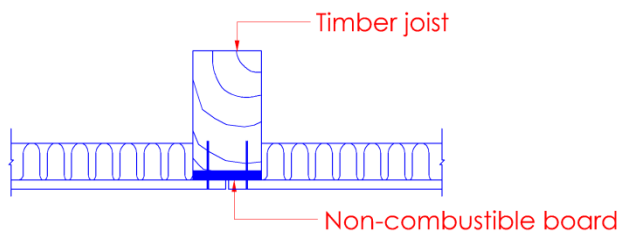

#### Detail A

The above is generally provided to prevent fire spread through the butt joint of the suspended ceiling

Diagram 3.3.6-3

*The implications of clause 3.3.6 are that the normal type of suspended ceiling consisting of separate tiles cannot be counted as contributing to the fire resistance of the floor in buildings over 15m high where the period required is one hour; or in buildings of any height where the period required is more than one hour. In these circumstances only jointless ceilings can be considered as contributing*

*The above diagram shows a protective ceiling being added to the underside of a timber floor, shall apply only to buildings under conservation where retention of the timber floor is required, and in buildings under Purpose Groups I & II for the construction of attic. In addition to the four grades of ceiling given in Table 3.3B, other ceiling construction to tested prototype listed in PSB product listing scheme would be considered as acceptable.*

*The ceiling shown in diagram 3.3.6 - 1, shall be constructed specifically as a fire protecting membrane and comply with Table 3.3B on limitation of fire protecting suspended ceiling. As the ceiling is intended as a protecting membrane, the concealed ceiling space shall not be used for recessed lighting and other service, such as air-con ducts, cables, pipes etc, even if these services are housed in fire rated enclosures.*

*Suspended Ceilings which are contributing to the Fire resistance rating of the floor under Table 3.3B.*

*Height of building less than 15m*

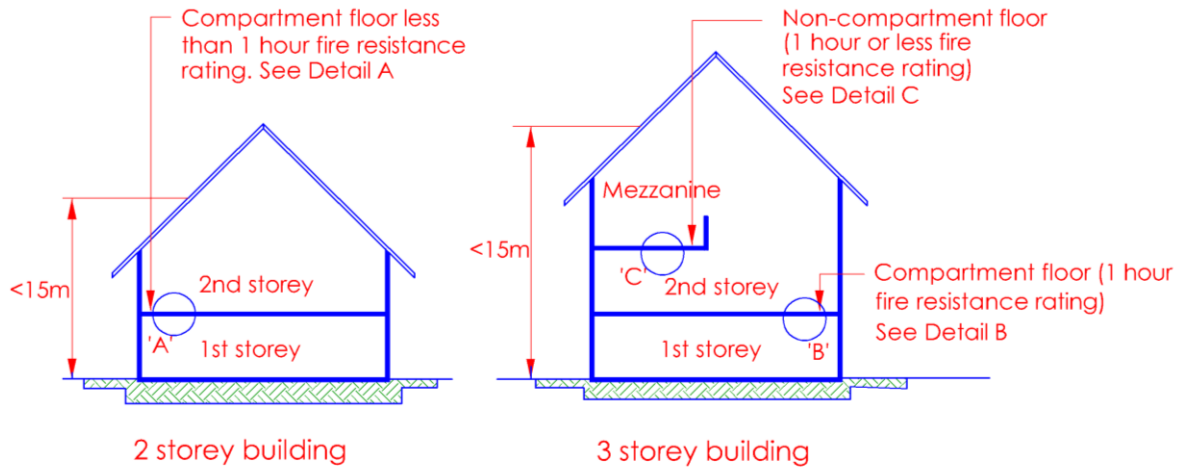
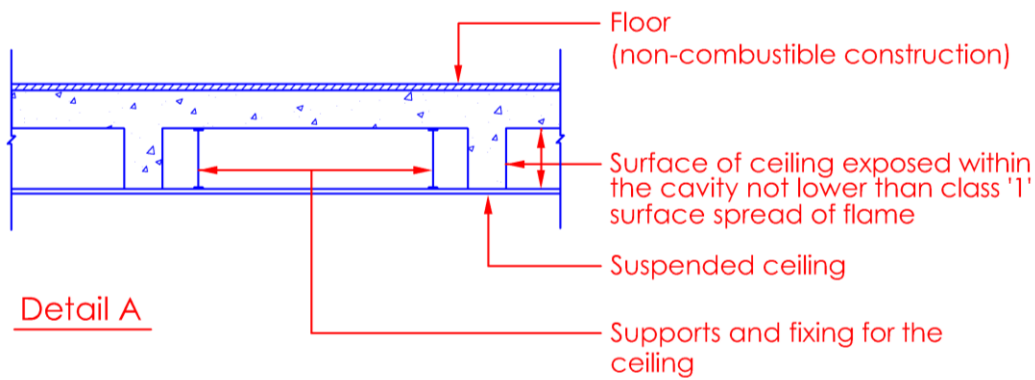
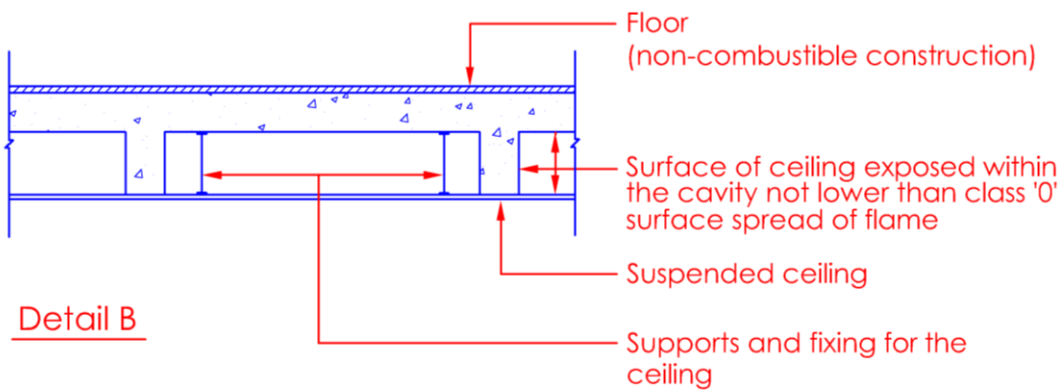

Diagram 3.3.6-4



*Compartment floor requiring less than 1 hour fire resistance rating*



*Compartment floor requiring 1 hour fire resistance rating*

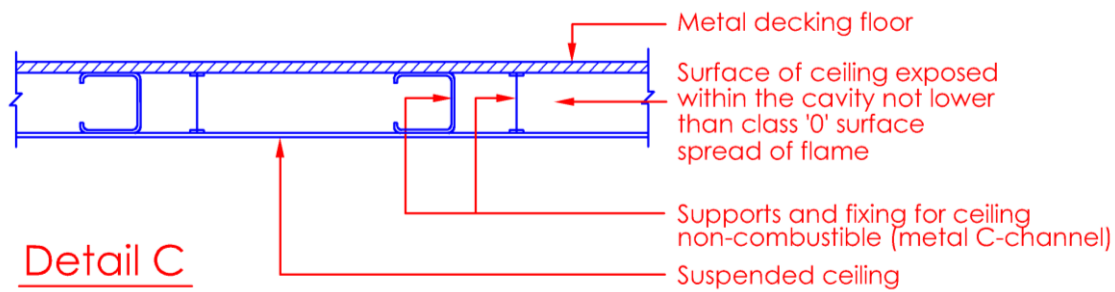

*Non-compartment floor requiring 1 hour or less fire resistance rating*

*Height of building – 15m or more*

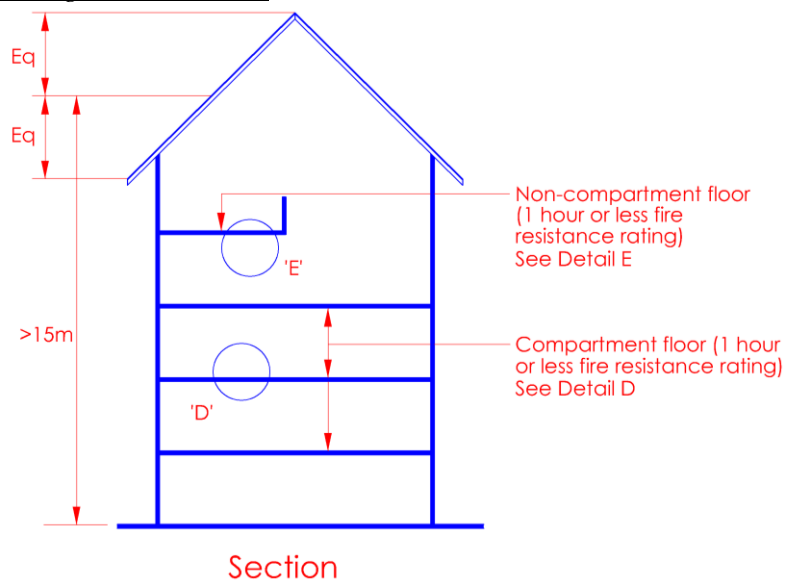

*Diagram 3.3.6-5*

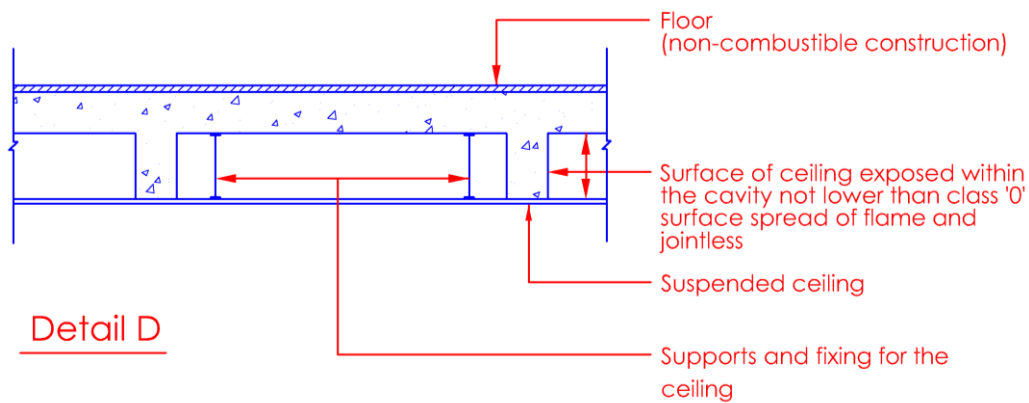

*Compartment floor requiring 1 hour or less fire resistance rating*

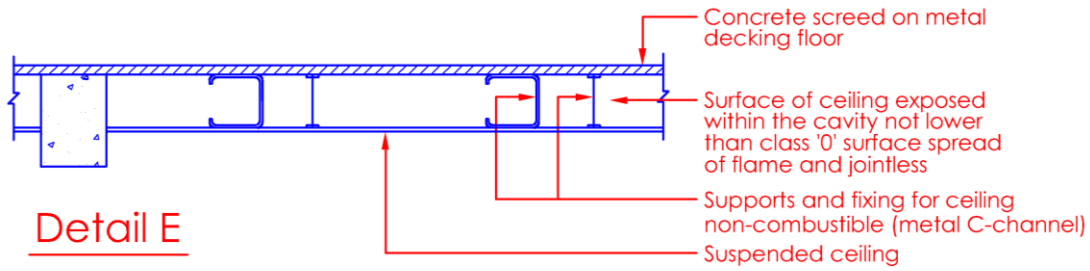

Non-compartment floor requiring 1 hour or less fire resistance rating

Height of building – any height

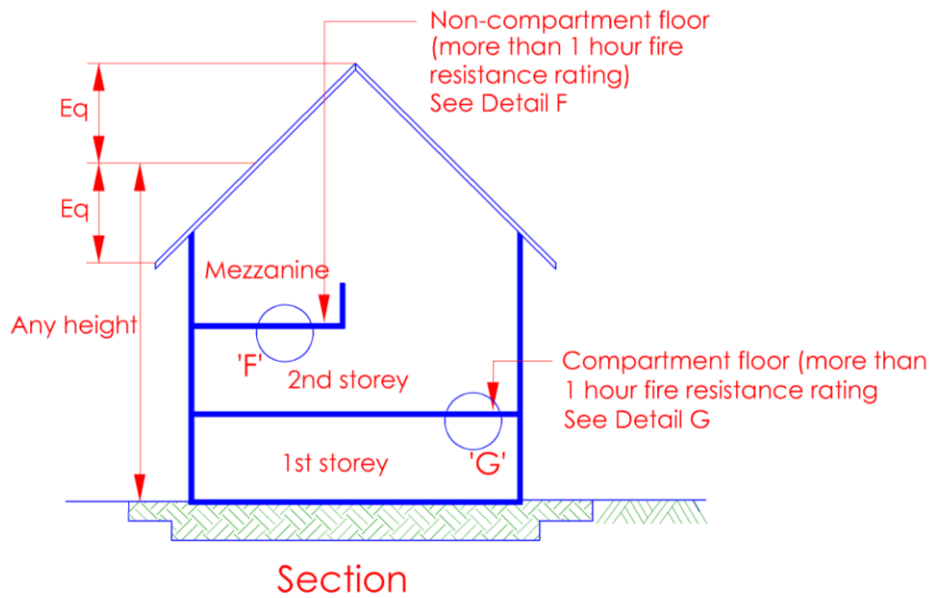
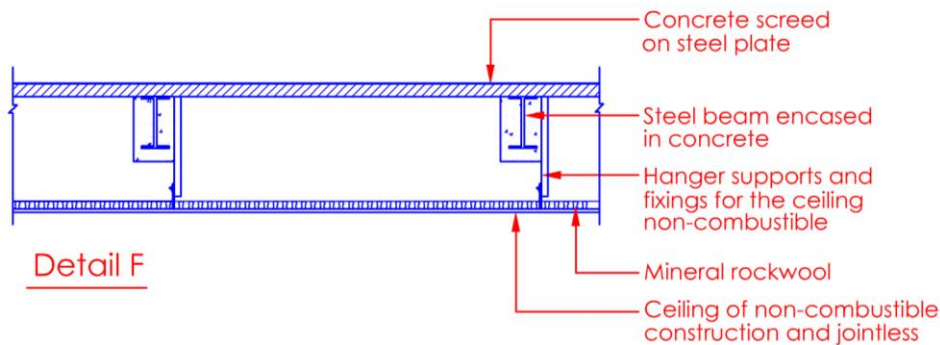
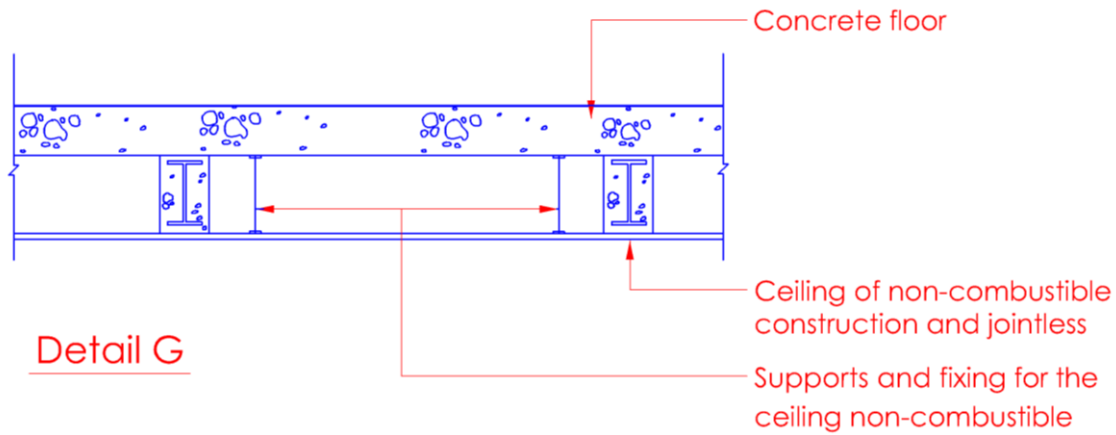

Diagram 3.3.6-6



Non-compartment floor requiring more than 1 hour or less fire resistance rating



Compartment floor requiring more than 1 hour fire resistance rating.

*The foregoing diagrams illustrate the intent of the clause which basically deals with the contribution by suspended ceilings to the fire resistance of floors. The provision of suspended ceilings for the protection of the floors shall be treated differently from that provided for the protection of structural steel works in the ceiling space.*

*Where the space above a suspended ceiling is protected by an automatic sprinkler system it shall be exempted from the requirements for non-combustibility and surface spread of flame classification as specified in the above Table, provided the ceiling is not situated over an exit passageway, protected lobby or other required protected means of escape, and that the ceiling space is not used as an air-plenum.*



# CHAPTER 3

## 3.3 FIRE RESISTANCE OF ELEMENTS OF STRUCTURE

### 3.3.7 Fire rated board

Fire rated boards are permitted to be used for protection to structural steel beams and columns in building if the following conditions are satisfactorily fulfilled :

- (i) Material shall be non-combustible (BS476 Pt 4 or Pt 11); and
- (ii) It shall have fire resistance for not less than the relevant period specified in Table 3.3A having regard to the purpose group of the building of which it forms a part and the dimensions specified in that Table; and
- (iii) It shall meet the criteria, in terms of water absorption and bending strength performance, when subject to test of BS EN 520 (for gypsum plaster board) or ISO 1896 (for calcium silicate or cement board); and
- (iv) Dry wall shall meet the criteria, in term of impact & deflection performance, when subject to the test of BS 5588 Pt 5 Appendix A and BS 5234 Pt 2; and

Note: Fire rated boards should not be used to protect structural steel in areas which may be subject to explosion risks as the boards may be displaced by the force of the blast.

In buildings under Purpose Groups VI & VIII, where there may be presence of corrosive atmosphere that may affect the effectiveness of fire rated board for protection to structural steel members of buildings, such proposal shall be subjected to evaluation of the Relevant Authority.

### EXPLANATIONS & ILLUSTRATIONS

*No illustration.*

*Running of services in the space between the steel structure and fire rated boards should be discouraged, unless it is unavoidable.*

*Services shall be limited to cables only and shall not include duct, gas pipes, fuel oil pipes, etc.*

# CHAPTER 3

## 3.4 TESTS OF FIRE RESISTANCE

### 3.4.1 Fire resistance

Performance for the fire resistance of elements of structure and other forms of construction shall be determined by reference to the methods specified in BS 476: Part 20 to 23, which specify tests for stability, integrity and insulation.

Specific requirements for each element in terms of the three performance criteria of stability, integrity and insulation are given in Table 3.4A.

### EXPLANATIONS & ILLUSTRATIONS

*In conjunction with Part 20, methods of test are provided for – Beams, columns, floors, flat roofs and walls(Part 21); Partitions, doorsets and vertical shutter assemblies, ceiling membranes and glazed elements(Part 22); and Suspended ceilings protecting steel beams and intumescent seals for use in conjunction with single acting latched timber fire-resisting door assemblies(Part 23). Part 20 specifies standard heating conditions based on a temperature/time curve (Diagram 3.4.1) which furnaces are required to follow; the temperature at defined locations close to the exposed face of the specimen under test rising to 821°C after 30 minutes and 1133°C after four hours.*

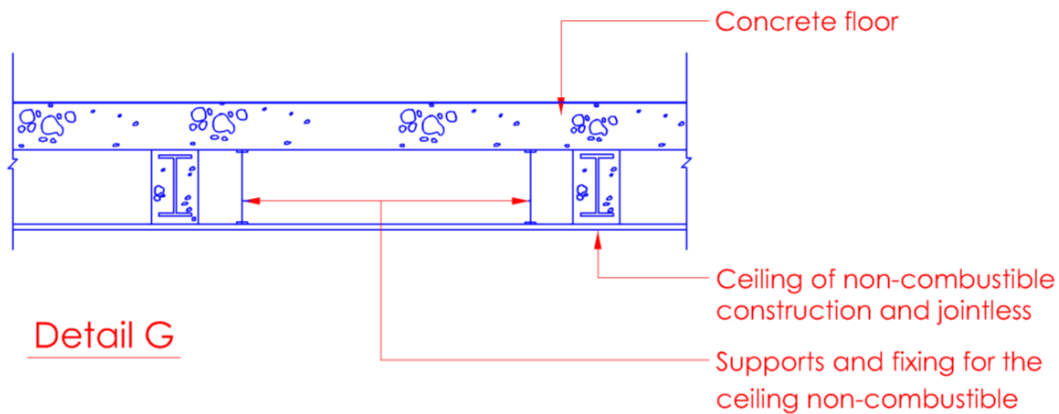
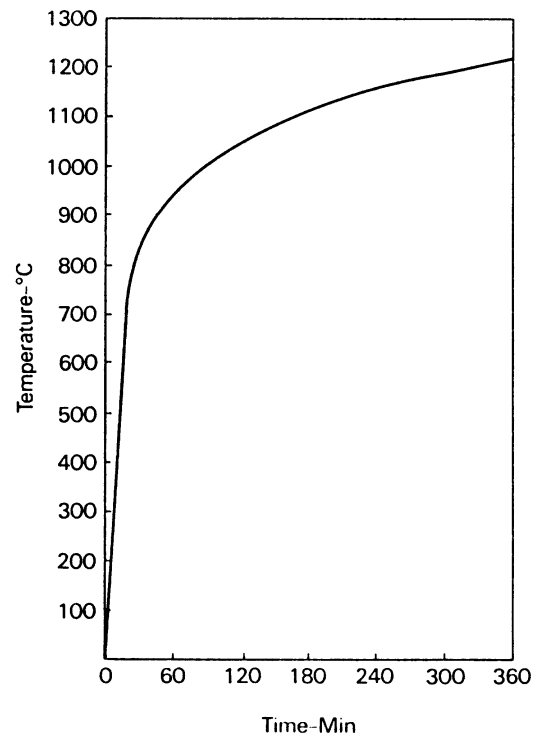

Diagram 3.4.1-1

*Diagram 3.4.1-2*

*Standard temperature/time curve (BS 476: Part 20 )*

*The specimen to be tested should be either full size or, where the element exceeds the size that can be accommodated by the furnace, it must have the following minimum dimensions.*

*Non-separating elements:*                      *Vertical 3m high*  
*Horizontal 4m span*

*Separating elements:*                         *Vertical 3m high X 3m wide*  
*Horizontal 4m high X 3m wide*

*Specimens are normally heated to simulate their exposure in a fire, eg walls from one side, floors from beneath and columns from all sides.*

*Elements of building construction are required to satisfy various criteria according to their designed function in the event of fire. These are:*

*“Stability” or “Loadbearing capacity”*                      *the ability of a loadbearing element to support its test load without excessive deflection;*

*“Integrity”*    *the ability of a separating element to resist collapse, the formation of holes, gaps or fissures through which flames and/or hot gases could pass, and the occurrence of sustained flaming on the unexposed face (the side of the specimen remote from the furnace)*

*the ability of a separating element to resist an excessive rise in temperature on its unexposed face.*

*“Insulation”*

*The criterion of “stability” or “loadbearing capacity” is applied only to loadbearing elements. For floors, flat roofs and beams, allowable vertical deflection is limited to 1/20 clear span.*

*Loss of “integrity” in the context of the formation of holes, gaps or fissures is judged by ignition of a cotton fibre pad. Where this test is not suitable, failure is deemed to have occurred if either a 25mm diameter gauge can penetrate into the furnace through a gap at any point, or a 6mm diameter gauge can penetrate into the furnace through an opening and can be moved for a distance of at least 150mm.*

*Loss of “insulation” occurs when the temperature on the unexposed face (the side of the specimen remote from the furnace) increases by more than 140°C (mean) or by more than 180°C at any point. Loss of “integrity” also constitutes loss of “insulation”.*

*Columns and beams have to satisfy only the criterion of “loadbearing capacity”; glazed elements are normally required to satisfy only “integrity”; and floors and walls have to satisfy all three criteria. It is pertinent to note that under Table 3.4A, doors are only required to satisfy “integrity”, leaving aside “insulation” as it is assumed unlikely that combustible materials would be stored against them. However, doors to protected lobbies, exit staircases and exit passageways should be provided with insulation against transmission of heat by radiation from the fire floor into the protected enclosures which occupants use for evacuation.*

*It is important to note that fire rated glass door shall not be used in fire lift shaft, exit staircases and exit passageways. In other areas such as protected lobbies, separating and compartment walls, the use of fire rated glass is permitted, provided the building is sprinkler protected. Please see clause 3.15.13 for more details.*

# CHAPTER 3

## 3.4 TESTS OF FIRE RESISTANCE

### 3.4.2 "Deem to satisfy" provisions

An element of structure or other part of a building shall be deemed to have the requisite fire resistance if –

- (a) It is constructed to the same specification as that of a specimen exposed to test by fire in accordance with the method and procedure under BS 476: Part 20 to 23, and satisfied the requirements of that test for the three performance criteria of stability, integrity and insulation for not less than the specified period, or
- (b) In the case of a wall, beam, column, stanchion or floor to which Appendix A to Cl. 3.4 relates, it is constructed in accordance with one of the specification set out in that Appendix and the notional period of fire resistance given in that Appendix as being appropriate to that type of construction and other relevant factors is not less than the specified period.

### EXPLANATIONS & ILLUSTRATIONS

*No illustration.*

*Sub-clause 3.4.2(b) provides the alternative to complying with the specification of tested prototype under BS476 Part 20 to 23. Specification set out in Appendix A to Cl.3.4 could be used and there is no need to obtain separate testing. However, on completion of the building works, the qualified person concerned is to forward to the RIs his/her certificate of supervision that the relevant specification listed in Appendix A to Cl. 3.4 had been complied with on site when applying for TFP or FSC.*

# CHAPTER 3

## 3.4 TESTS OF FIRE RESISTANCE

### 3.4.3 Timber floors

The use of timber floors shall not be allowed, except:

- (a) for an attic in buildings under Purpose Groups I and II; and
- (b) in buildings designated for conservation where the timber floors are required to be retained, but subject to compliance with the technical guidelines for ‘FIRE SAFETY REQUIREMENTS AFFECTING SHOPHOUSES UNDER CONSERVATION.’
- (c) for buildings that were existing before 1969 under Cl.1.1.2.

### EXPLANATIONS & ILLUSTRATIONS

*No illustration.*

*SCDF (FSSD) issued a circular on 13 Jan 99, to allow the “Fire Safety Requirements Affecting Shophouses Under Conservation” be made applicable to old shophouses not designated for conservation. Please refer Appendix (1) for more details.*

# CHAPTER 3

## 3.5 EXTERNAL WALL

### 3.5.1 Requirements of external walls

Requirements of External Walls shall be as follows:

- (a) Any external wall of a building or a separated part of a building which constitutes or is situated within a distance of 1m from any point on the relevant boundary, or is a wall of a building or a separated part of a building which exceeds 15m in height shall:
  - (i) be constructed wholly of non-combustible materials apart from any external cladding which complies with Cl. 3.5.4 or any internal lining which complies with Cl.3.13.4, and
  - (ii) be so constructed as to attain the fire resistance required by this chapter, and

### EXPLANATIONS & ILLUSTRATIONS

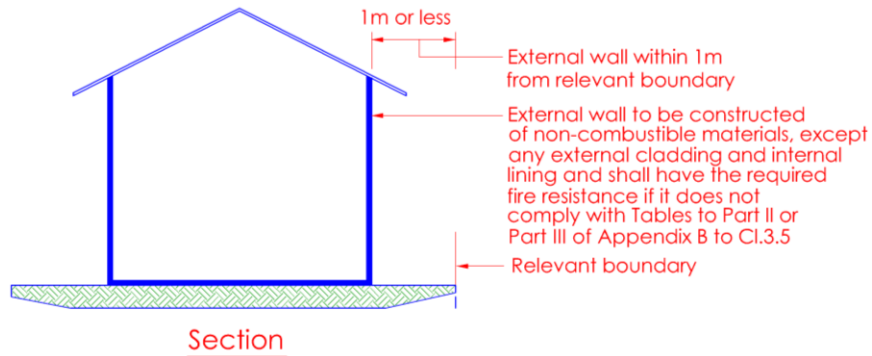

Diagram 3.5.1-(1)

*Buildings of any height situated at 1m or less from relevant boundary*

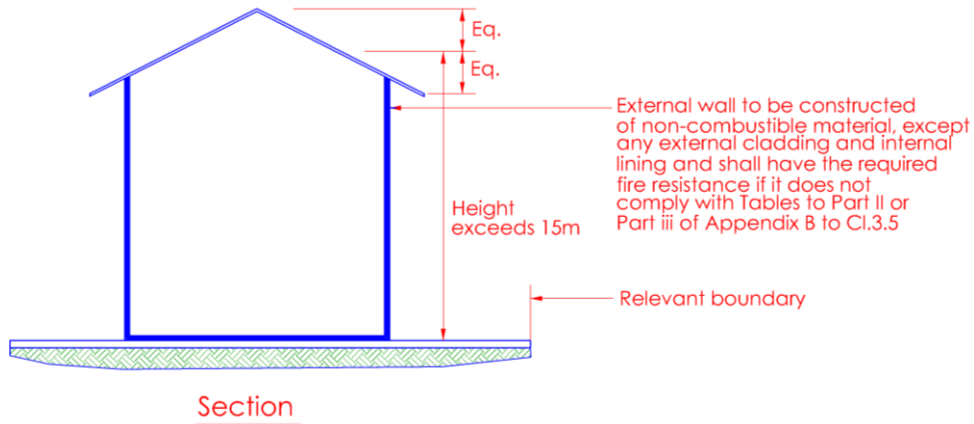

Diagram 3.5.1-(2)

- *Where the external wall of a building which exceeds 15m in building height or is within 1m of the relevant boundary, the entire external wall shall be constructed wholly of non-combustible materials, apart from any external combustible cladding under Cl.3.5.4 or internal combustible lining under Cl.3.13.4.*
- *The external wall of building which is sited less than 1m from the relevant boundary, shall be imperforate, free of any unprotected area and have the necessary fire resistance rating, both inside and outside. The required fire resistance shall be achieved by the non-combustible part alone.*
- *The external wall shall have the necessary fire resistance rating as required of the elements of structure of the building or compartment, in which the wall is located, in accordance with Table 3.3A, Part 1.*
- *Any part of the external wall which is to be treated as unprotected area in accordance with Tables to Part II of Appendix 'B' to Cl.3.5, need not have fire resistance.*
- *If the entire external wall is to be treated as unprotected area, the separation distance between the external wall and the relevant boundary shall comply with Tables to Part II of Appendix 'B' to Cl.3.5.*
- *External walls, which are more than 1m from the boundary, need to resist the effect of fire from the inside only.*

*Note: "Cl.3.5.2" appearing in sub-clause 3.5.1(a)(i) should read as "Cl.3.5.4".*

*In cases where the external walls of buildings are situated less than 1m from relevant boundary, the external walls shall be treated as separating walls. The requirements under Cl.3.6 shall be fully complied with.*



(b) Any beam or column forming part of an external wall and any structure carrying an external wall which is required to be constructed of non-combustible material, shall comply with the provisions of sub-cl.(a).

**EXPLANATIONS & ILLUSTRATIONS**

**3.5.1**

*No illustration.*

*Any beam or column forming part of an external wall and any structure carrying an external wall shall be constructed of non-combustible materials and have the necessary fire resistance rating of elements of structure, apart from any external cladding which complies with Cl.3.5.4 or any internal lining which complies with Cl.3.13.4. The required fire resistance shall be achieved by the non-combustible part alone.*

# CHAPTER 3

## 3.5 EXTERNAL WALL

### 3.5.2 Exceptions

- (a) The requirements of Cl.3.5.1(a)(i) for non-combustibility of external walls shall not apply to the external wall of a building or separated part of a building-
- (i) if that wall is:
- (1) situated 1m or more from the relevant boundary; and
  - (2) not exceeding 15m in height; and
  - (3) separated as described in Cl.3.3.4(b); or
- (ii) if that wall is situated 1 m or more from the relevant boundary:
- (1) of Purpose Group I and II of not more than three storeys, or
  - (2) of single storey construction and not exceeding 15m in height and floor area not exceeding –  
  
purpose group III, IV, VII - 3000m<sup>2</sup>  
purpose group V, VI - 2000m<sup>2</sup>  
purpose group VIII - 500m<sup>2</sup> ;  
  
or
  - (3) other than single storey buildings, but not exceeding 7.5m in height and floor area not exceeding –  
  
purpose group IV, VI, VII - 250m<sup>2</sup> ;  
purpose group V, VIII - 150m<sup>2</sup>.
- (b) The requirements of Cl.3.5.1(a)(ii) for fire resistance of external walls shall not apply to the external wall of a building or separated part of a building –
- (i) if that wall is situated 1 m or more from the relevant boundary:
- (1) for single storey buildings not exceeding 15m in height and floor area not exceeding 2000 m<sup>2</sup> or 500 m<sup>2</sup> under purpose groups VI or VIII respectively; and
  - (2) such wall shall be provided with minimum period of 15 minutes insulation from inside the building under BS 476: Part 20 to 23.

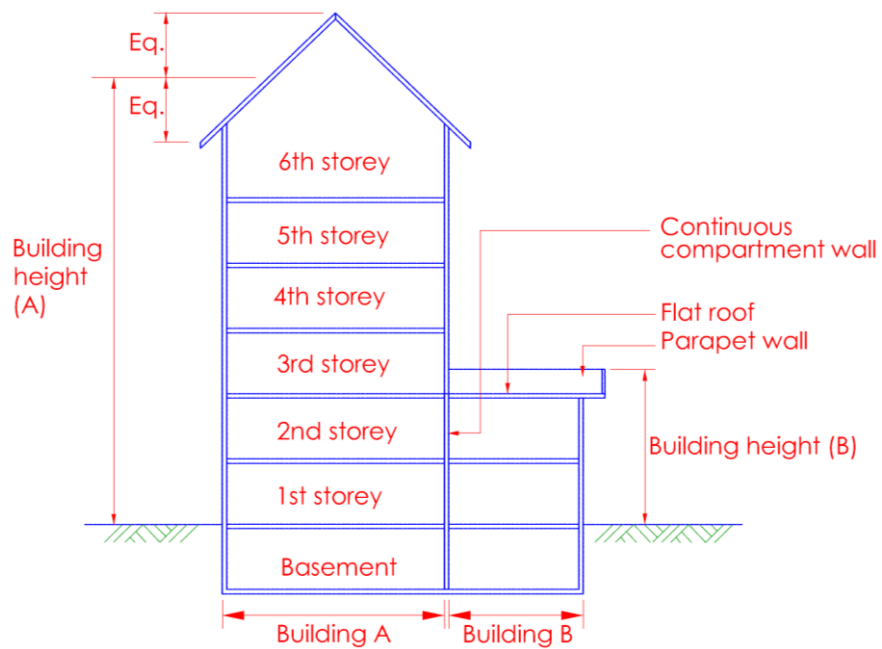

Diagram 3.5.2(a)-1

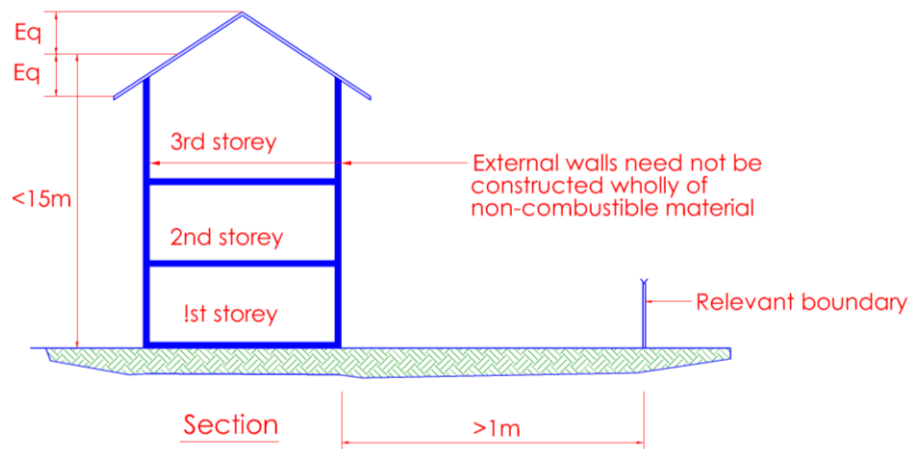

Diagram 3.5.2(a)-2

Part of a Purpose Group II building (not exceeding 3 storey – building A in diagram 3.5.2(a)-1), separated from the other parts (building B) by vertical compartment wall. Exemption would also apply to the building B in diagram 3.5.2(a)-1 which shall not exceed 3 storey in height and be situated 1m or more from the relevant boundary.

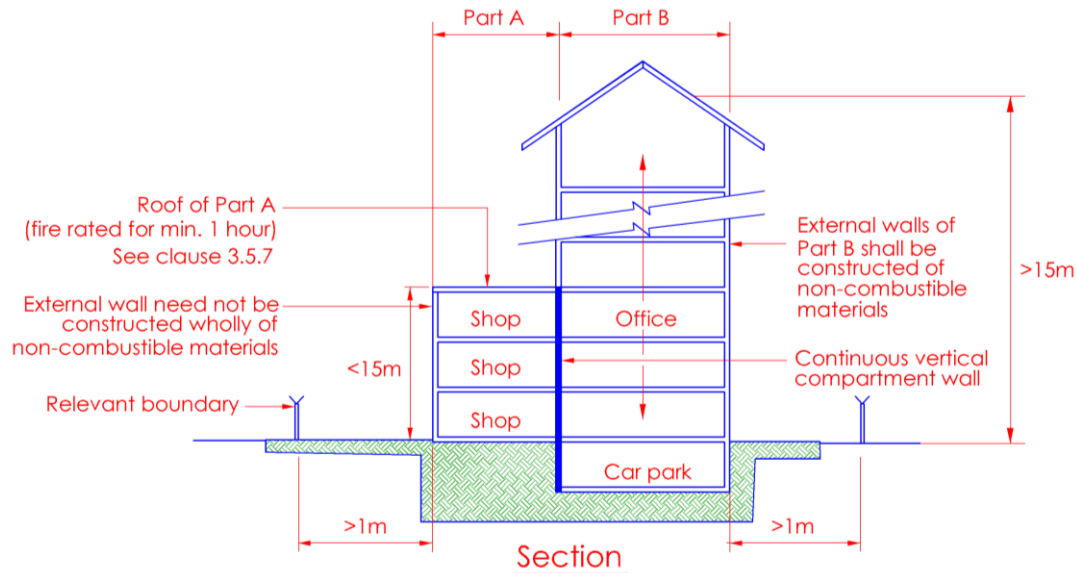

Diagram 3.5.2(a)-3

The above sub-clause is applicable to separated part of building as described in Cl.3.3.4(b), which is illustrated in diagram 3.5.2(a)-3.

Part A of the building comprising shops which is separated from other parts of the same building by a continuous vertical compartment wall would qualify for exemption of non-combustibility of external construction if;

- (a) the entire external wall does not exceed 15m in height, measured from the outside ground; and
- (b) the external wall is situated 1m or more from the relevant boundary.

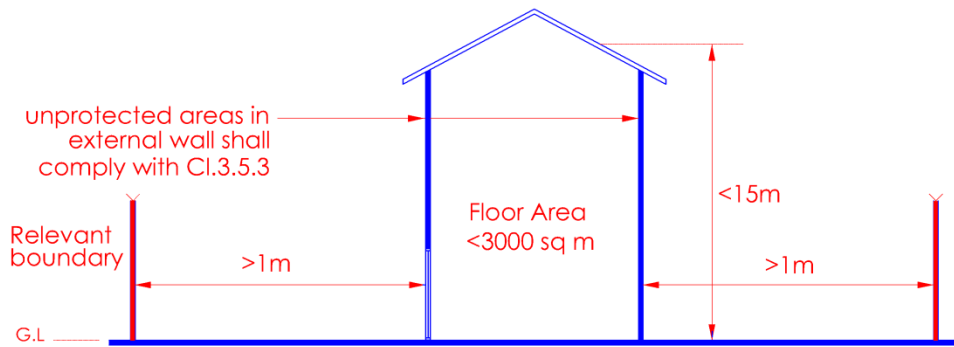

Diagram 3.5.2(a)(ii)

*Single storey health care occupancy, schools, old folk's home, etc (Purpose Group III) need not comply with non-combustibility of external wall, if it complies with the requirements under sub-clause a(ii) above.*

# CHAPTER 3

## 3.5 EXTERNAL WALL

### 3.5.3 Unprotected areas in any side of a building

Except where otherwise provided, unprotected areas in any side of a building shall comply with the following:

- (a) Any relevant requirements relating to the permitted limits of unprotected areas specified in Appendix B unless the building is so situated that such side can in accordance with Appendix B consists entirely of any unprotected area, and

### EXPLANATIONS & ILLUSTRATIONS

*No illustration.*

*Unprotected areas in relation to a side or external wall of a building means:*

- (i) a window, door or other opening, and*
- (ii) any part of the external wall which has less than the relevant fire resistance required in cl.3.5, and*
- (iii) any part of the external wall which has combustible material more than 1mm thick attached or applied to its external face whether for cladding or any other purpose*

*The extent of unprotected areas in the external wall in relation to the setback from relevant boundary or lot boundary shall be in accordance with Appendix B to Cl.3.5. The further the building is setback from the relevant boundary, the greater the amount of unprotected areas would be permitted.*

*An example on calculations of unprotected openings/setback from relevant boundary is given in page 56. The intensity of the heat produced by a fire within a building which can reach the relevant boundary will depend upon the extent of the “unprotected areas” in the external walls and the distance between these walls and the relevant boundary. The heat flux at the relevant boundary shall be less than that normally required for pilot ignition of combustible material after a period of exposure.*

*In situations where the extent of unprotected areas in external walls do not comply to Appendix B, the qualified person has 4 alternatives. These are:*

- (a) reduce the total unprotected area; or*
- (b) increase the distance from the relevant boundary; or*
- (c) introduce compartmentation within the building to break up the size of enclosing rectangle or*
- (d) introduce automatic sprinkler system so that the unprotected areas can be doubled or the distance from the relevant boundary can be reduced by half.*

(b) The extent of unprotected openings in an external wall of a building or compartment in relation to its distance from the lot boundary can be doubled that which is specified in Appendix B when the building or compartment is :

- (i) used solely for the sale, storage and processing involving goods and substances of a non-combustible nature, or
- (ii) fitted throughout with an automatic sprinkler system in compliance with the requirements in Chapter 6.

**EXPLANATIONS & ILLUSTRATIONS**

**3.5.3**

*No illustration.*

*Warehouse used for storage of valves, steel bars & pipes are of non-combustible nature. Storage used for combustible materials such as paper box would require separate building plan submission and approval from SCDF "FSSD".*

*For sub-clause b(ii), more relaxation is granted with installation of sprinkler system taking into consideration the expected fire size.*

(c) As an alternative to (b)(ii) above, the distance between the external wall of a building and the relevant boundary can be half that specified in Appendix B if the building is fitted throughout with an automatic sprinkler system in compliance with the requirements in Chapter 6.

**EXPLANATIONS & ILLUSTRATIONS**

**3.5.3**

*No illustration.*

*The above clause is to provide an alternative for buildings protected with sprinkler system. Qualified Person/Building owner shall decide which option, clause (b) or (c) i.e either double the unprotected openings or half the separation distance between the building and the relevant boundary, whichever is relevant to the building.*



(d) The extent of unprotected openings in an external wall of a building or part of building used for carparking in relation to its distance from the lot boundary or relevant boundary can be based on the floor having the largest extent of unprotected openings for the purpose of complying with Table 1 of Appendix B.

## EXPLANATIONS & ILLUSTRATIONS

## 3.5.3

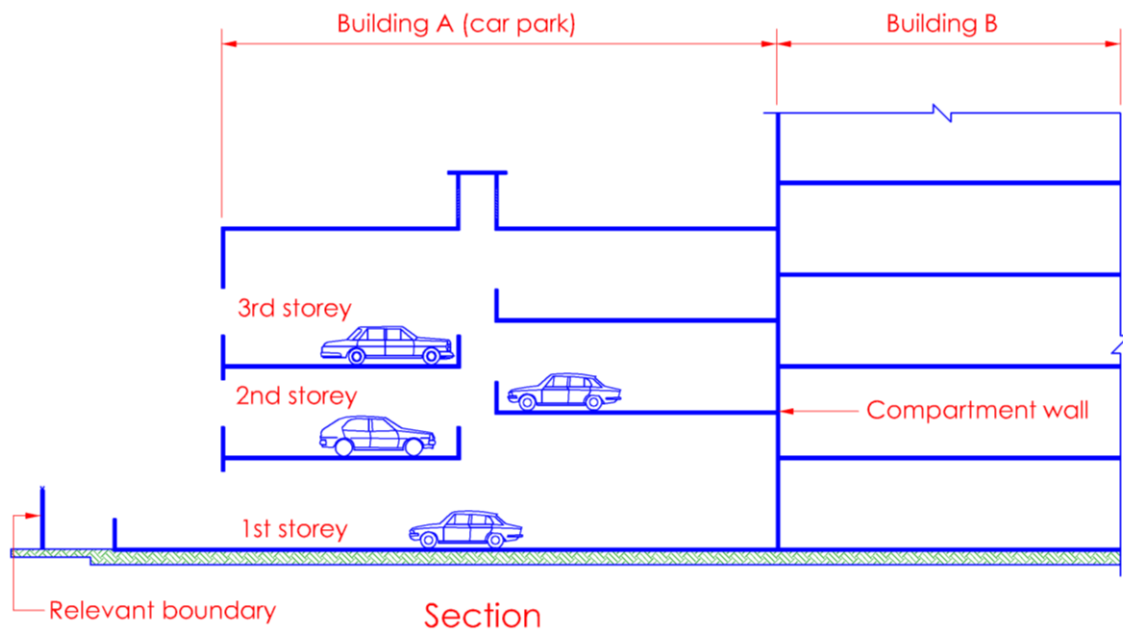

Diagram 3.5.3(d)

The above clause treats car park building differently by allowing the floor having the largest extent of unprotected openings to be used for the purpose of complying with Table 1 of Appendix B. This clause grants special relaxation in relation to its distance from the lot boundary for the purpose of complying with Table 1 of Appendix B.

In the above diagram, the enclosing rectangle would apply to 1<sup>st</sup> storey elevation facing the relevant boundary, instead of the whole building, which forms one compartment.

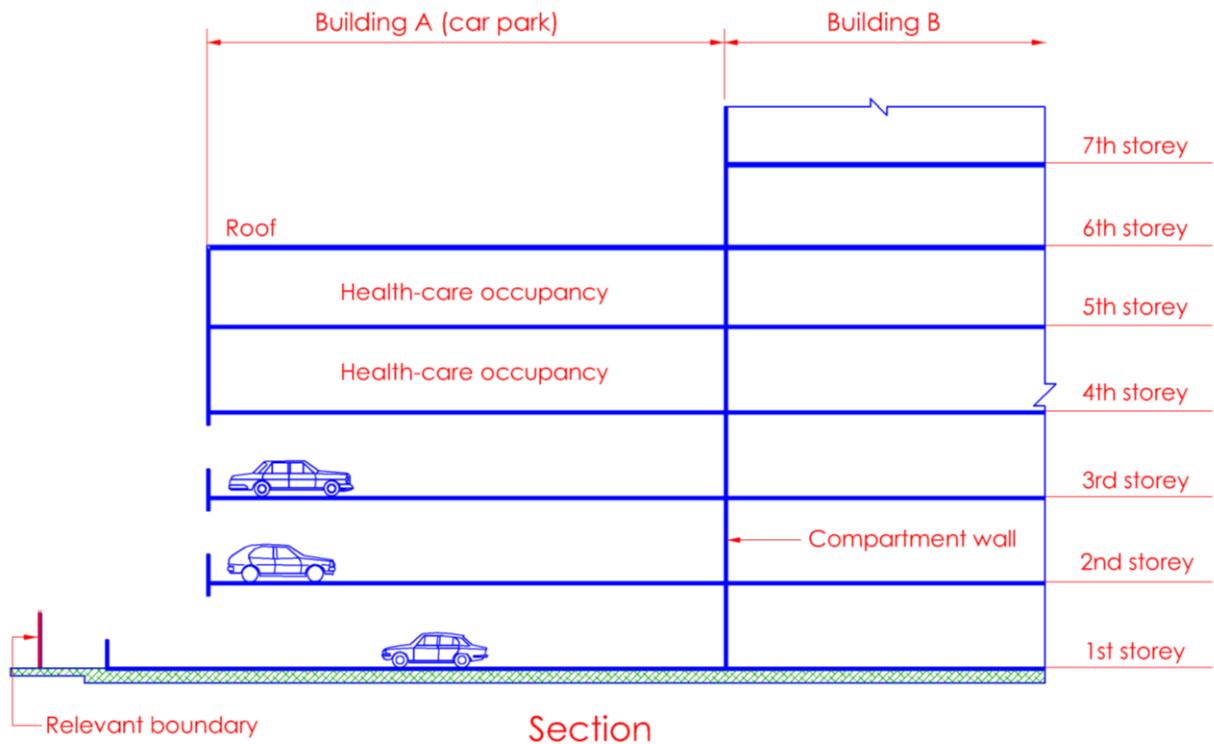

Diagram 3.5.3(d)

The above clause treats car park building differently by allowing the floor having the largest extent of unprotected openings to be used for the purpose of complying with Table 1 of Appendix B. This clause grants special relaxation in relation to its distance from the lot boundary for the purpose of complying with Table 1 of Appendix B.

In the above diagram, the enclosing rectangle would apply to 1<sup>st</sup> storey elevation facing the relevant boundary, instead of the whole building, which forms one compartment.

- (e) (i) The extent of unprotected openings in an external wall of a building under Purpose Group I in relation to its distance from the relevant boundary can be based on the internal room/space in the building that has the largest extent of unprotected openings for purpose of complying with Table 1 of Appendix “B”.
- (i) Internal walls enclosing the room/space in the building are not required to be fire rated but shall be constructed of non-combustible materials, except glazing.

## EXPLANATIONS & ILLUSTRATIONS

## 3.5.3

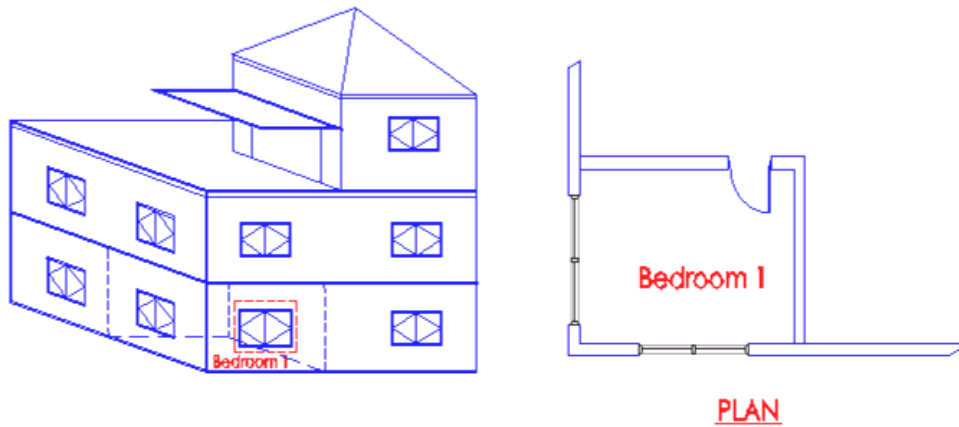

Diagram 3.5.3(e)

*The relaxation of the enclosing rectangular for individual room is only applicable to buildings under Purpose Group I. This is because every room is enclosed by walls and could be construed as a compartment for the calculations of unprotected openings and setback requirement.*

# CHAPTER 3

## 3.5 EXTERNAL WALL

### 3.5.4 Cladding on external walls

Cladding on External Walls shall comply with the following:

- (a) If such cladding is situated less than 1m from any point on the relevant boundary, it shall have surface complying with the requirements for Class '0', and
- (b) If such cladding is situated 1m or more from the relevant boundary it shall have, if the building is more than 15m in height, a surface complying with the requirements specified for Class '0', except that any part of such cladding below a height of 15m from the ground may consist of timber of not less than 9mm finished thickness or of a material having a surface which, when tested in accordance with BS 476: Part 6 have an index of performance (I) not exceeding 20, provided that if the building is of Purpose Group VI or VIII, such cladding material shall, when tested in accordance with BS 476: Part 6 have an index of performance (I) not exceeding 12 and a sub-index ( $i_1$ ) not exceeding 6.

### EXPLANATIONS & ILLUSTRATIONS

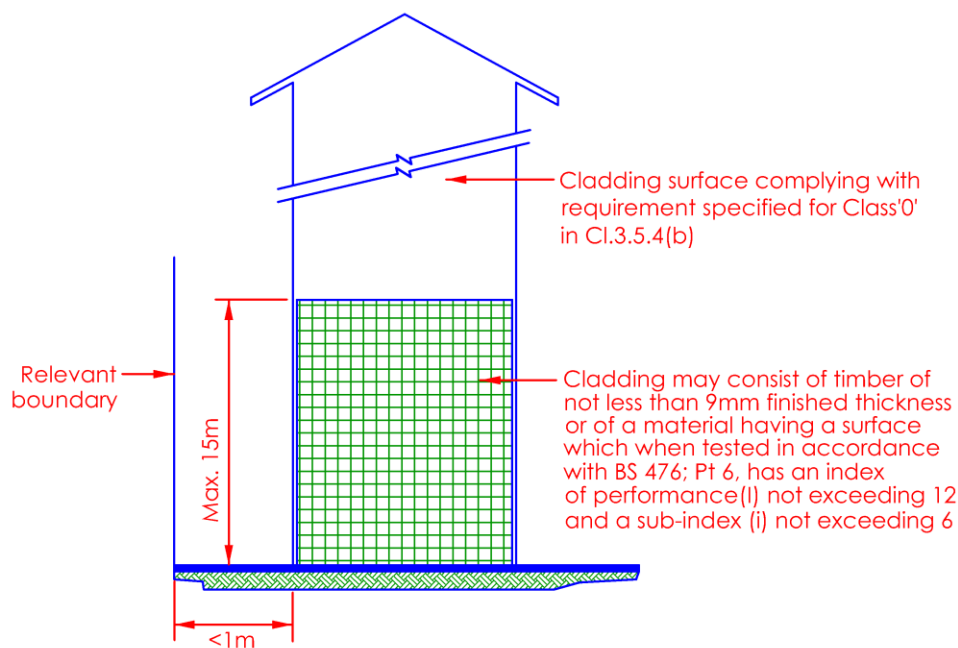

Diagram 3.5.4(a)

- (a) If such cladding is situated less than 1m from the relevant boundary, it shall have surface complying with the requirements for Class '0'.

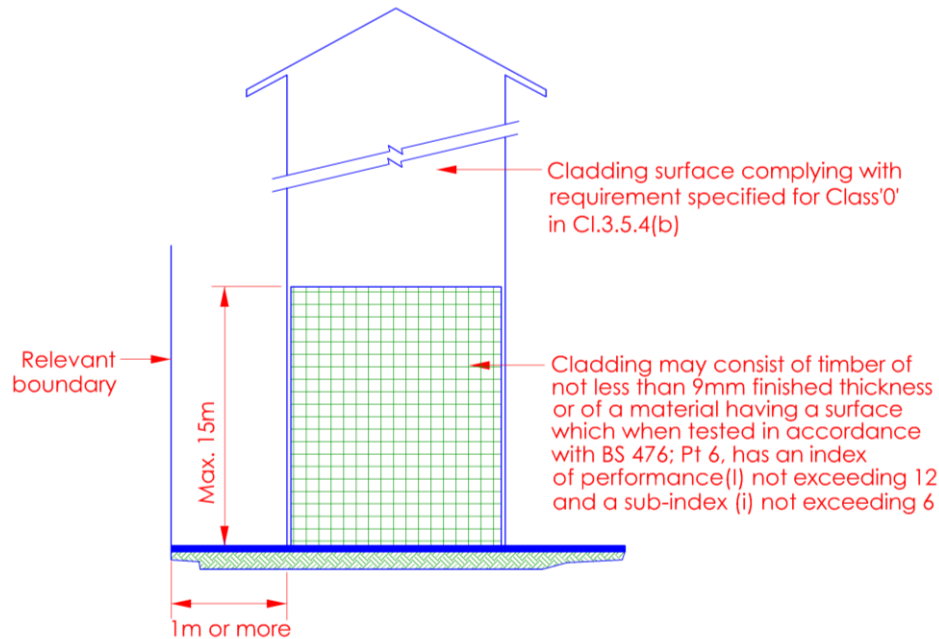

Diagram 3.5.4(a)

If such cladding is situated 1m or more from the relevant boundary and the building is more than 15m,

- (i) any part that is situated above 15m from the ground shall have a surface complying with the requirements for Class '0'.
- (ii) any part that is situated below a height of 15m from the ground may consist of timber of finished thickness greater than 9mm or of a material having a surface which, when tested in accordance with BS 476 Pt 6 has an index of performance (I) not exceeding 12 and a sub-index  $i_1$ , not exceeding 6. The index of performance is derived from the fire propagation test which provides a comparative measure of the contribution a material will make to the heat build-up and thus to fire spread within a room or space.
- (iii) Values of index of performance (I) range in descending order of merit from '0' (non-combustible material eg. metal) to '100' (highly combustible material). For example, 13mm thick fibre insulation board has an index of performance (I) 66.4 and a sub-index  $I_1$ , 41, 18mm thick hardwood has the value of 34.9 and a sub-index  $I_1$ , 9.5 and 13mm thick plaster board has the value of 9.9 and a sub-index  $I_1$ , 5.8. Low values indicate a low rate of heat release.
- (iv) Values of index of performance (I) is obtained from :  $I = i_1 + i_2 + i_3$  where sub-index  $i_1$ , is derived from the first three minutes of test,  $i_2$  from the following seven minutes, and  $i_3$  from the final ten minutes. A high index  $i_1$  indicates an initial rapid ignition and heat release.

## APPENDIX 'B' TO CL.3.5

***PART 1***

## CALCULATION OF PERMITTED LIMITS OF UNPROTECTED AREAS

*General rules applicable to this Appendix*

1. *The permitted limit of unprotected areas in any side of a building or compartment shall be calculated by reference to the requirements of Part II or III (whichever is applicable under Cl.3.5)*

### Unprotected Areas in External Wall

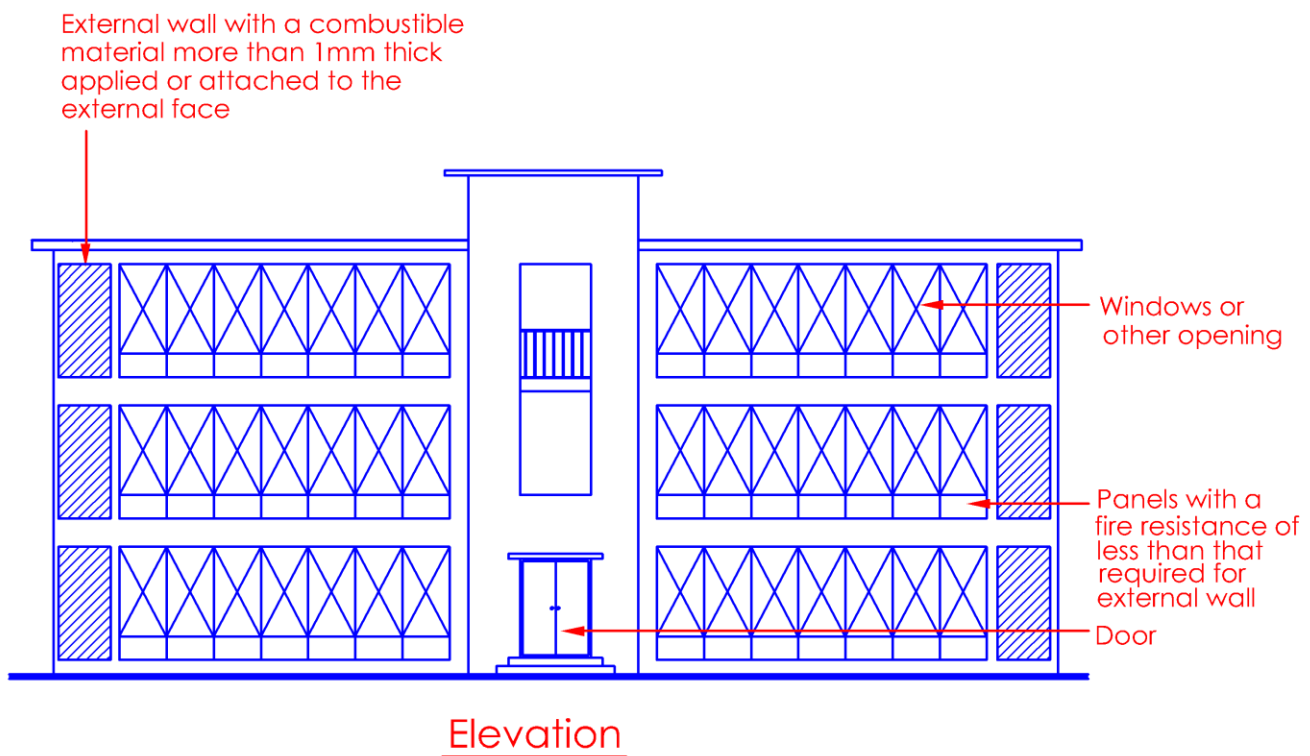

2. *For the purpose of this Appendix, the expression “unprotected area” has the meaning ascribed to it by Cl.1.2.61, but in calculating the size of unprotected areas or the permitted limit of unprotected areas, the following provisions shall apply –*
  - (a) *Where any area of an external wall is an unprotected area, only because it has combustibile material attached to it as cladding, the area shall be deemed to be half the area of such cladding;*

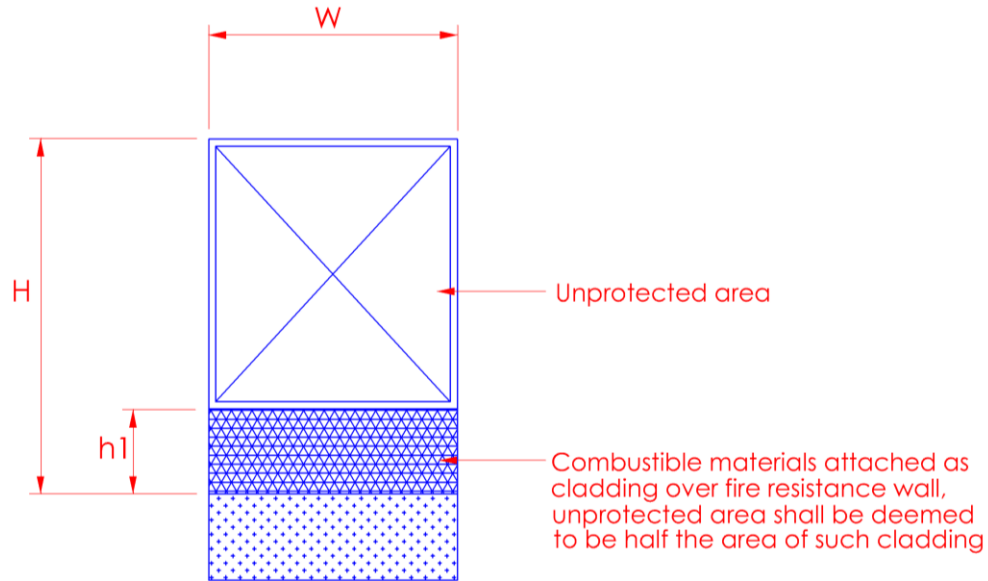

Part Elevation of External Wall

Diagram 2(a) Pt.I Appendix B

$$\text{Total unprotected area} = W \times H - \frac{1}{2} (W \times h1)$$

(b) No account shall be taken of the following –

- (i) an unprotected area which does not exceed  $0.1\text{m}^2$  and which is not less than 1.5m from any other unprotected area in the same side of the building or compartment (unless that other falls within (iii) below);
- (ii) one or more unprotected areas having an areas (or, if more than one, the aggregate area) not exceeding  $1\text{m}^2$  and not less than 4m from any other unprotected area in the same side of the building or compartment (except any such area as is specified in (1) above);
- (iii) an unprotected area in any part of an external wall which forms part of a protected shaft;
- (iv) an unprotected area in the side of a building not divided into compartments, if the area is not less than 28m above any ground adjoining that side of the building.

No account shall be taken of the following : -

- (i) Unprotected area not exceeding 0.1m<sup>2</sup> and not less than 1.5m from other unprotected area

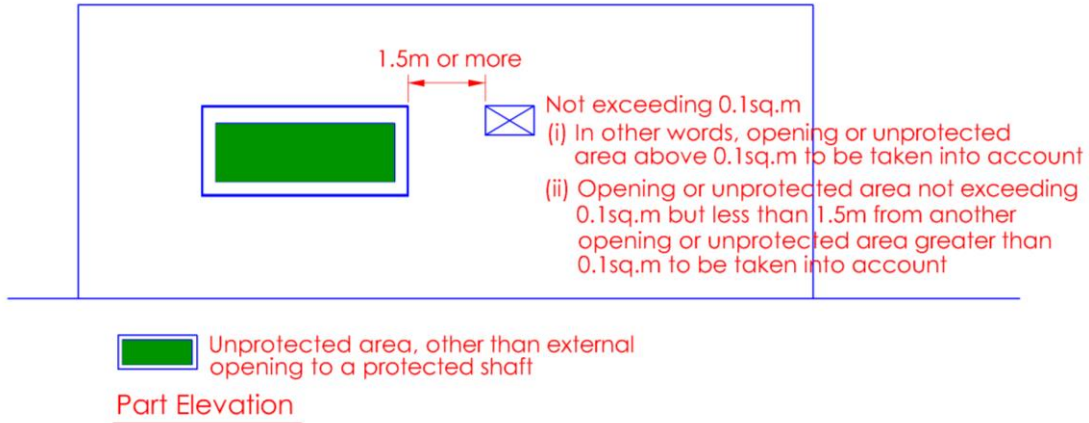

Diagram 2(b)(i) – Pt. I Appendix B

- (ii) Unprotected area or aggregate area not exceeding 1m<sup>2</sup> and not less than 4m from other unprotected area

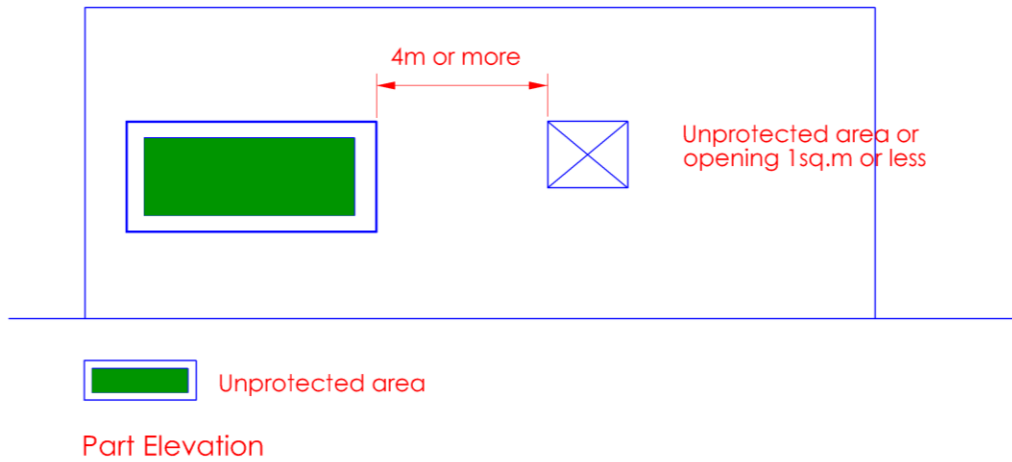
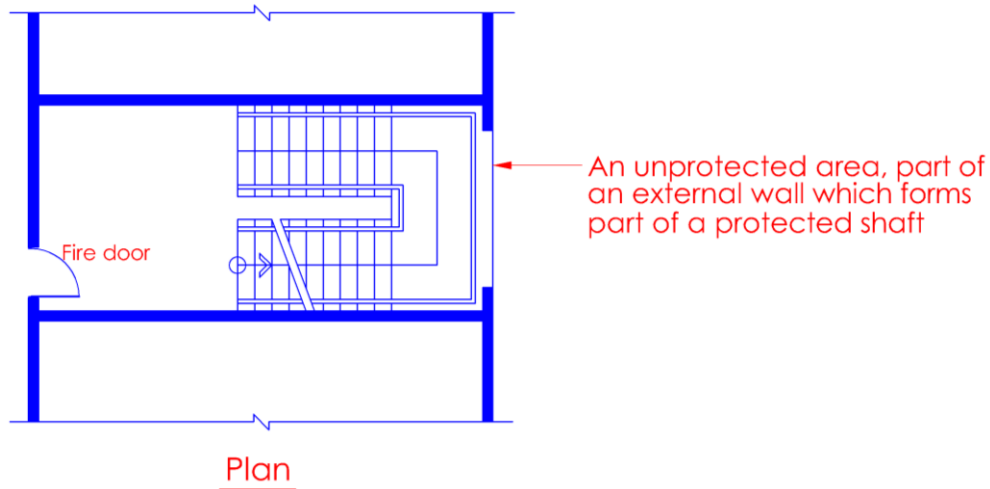

Diagram 2(b)(ii) – Pt. I Appendix B



(iii) *Unprotected area in external wall of protected shaft*



No account shall be taken of unprotected area in external wall of protected shaft

Diagram 2(b)(iii) – Pt. I Appendix B

(iv) *Unprotected area above 28m of uncomparted building*

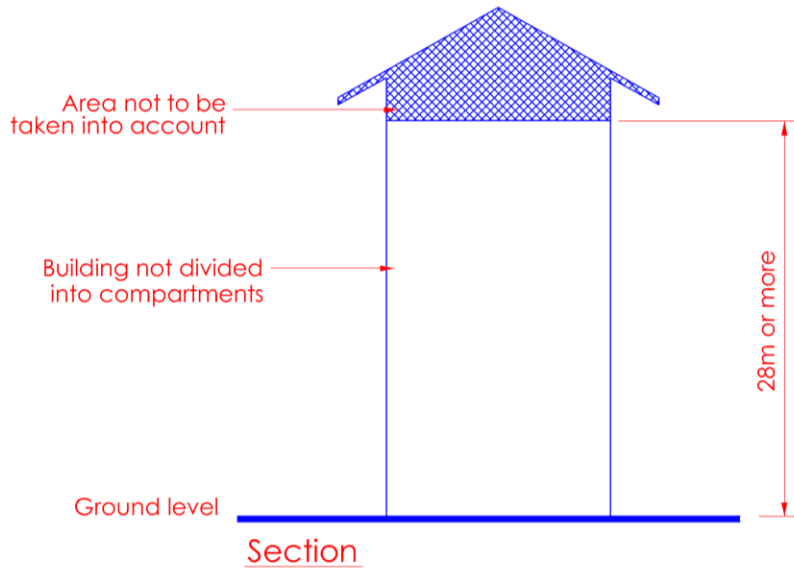

No account shall be taken of any unprotected area 28m or more above the ground in the external wall of building not divided into compartment

Diagram 2(b)(iv) – Pt. I Appendix B

**PART II***Rules of calculation by reference to an enclosing rectangle*

3. *The conditions of this Part of this Appendix shall be satisfied if a building or compartment is so situated that no point on the relevant boundary is either between relevant plane of reference and the side of the building or compartment or at a distance from the relevant plane of reference which is less than the distance specified in the tables to Part of this Appendix, according to the purpose group of the building or compartment, the dimensions of the enclosing rectangle and the unprotected percentage.*

4. *For the purpose of this Part of this Appendix:*

*“relevant boundary” means as defined in Cl.1.2.52 and for the purpose of this calculation is either parallel to the side of the building under consideration or at an angle of not more than 80° with that side;*

*“plane of reference” means any vertical plane which touches the side or some part of the side of a building or compartment but which (however far extended) does not pass within the structure of such building or compartment (and for this purpose, any balcony, coping or similar projection shall be deemed not to be part either of that side or of the structure); and the relevant plane of reference shall in each case be taken as that most favourable in that respect to the person erecting the building;*

*“enclosing rectangle” means the smallest rectangle on the relevant plane of reference which would-*

(a) *enclose all the outer edge of any unprotected area of the building or, if the building is divided into compartments, of the compartment (other than any of an unprotected area which is at an angle of more than 80° to the plane of reference the outer edges being for this purpose projected on the plane of reference by line perpendicular to such plane:*

(b) *have two horizontal sides: &*

(c) *have height and width falling within those listed in the tables to this Part of this Appendix:*

*“unprotected percentage” means the percentage of the area of the enclosing rectangle which is equal to the aggregate areas taken into account in calculating the enclosing rectangle and as projected on it.*

Determining the relevant boundaries

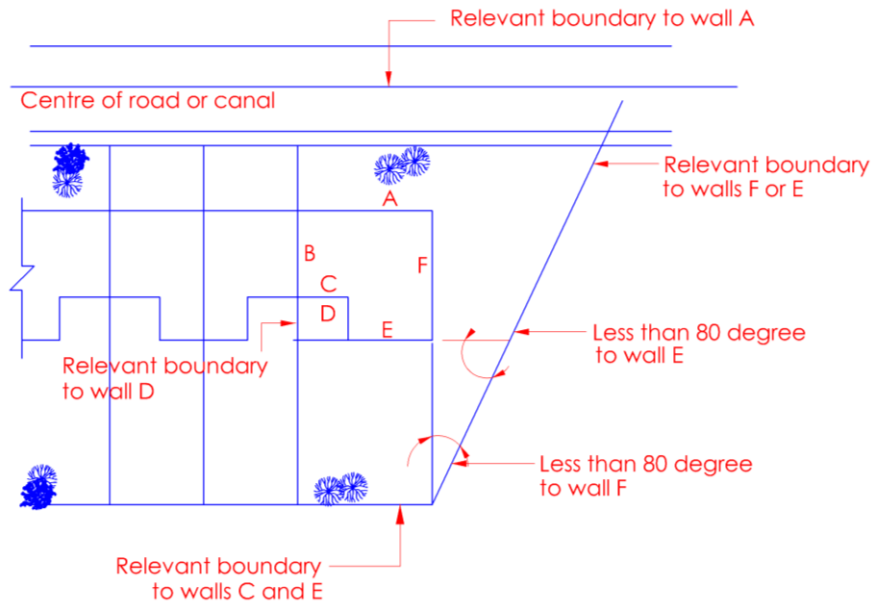
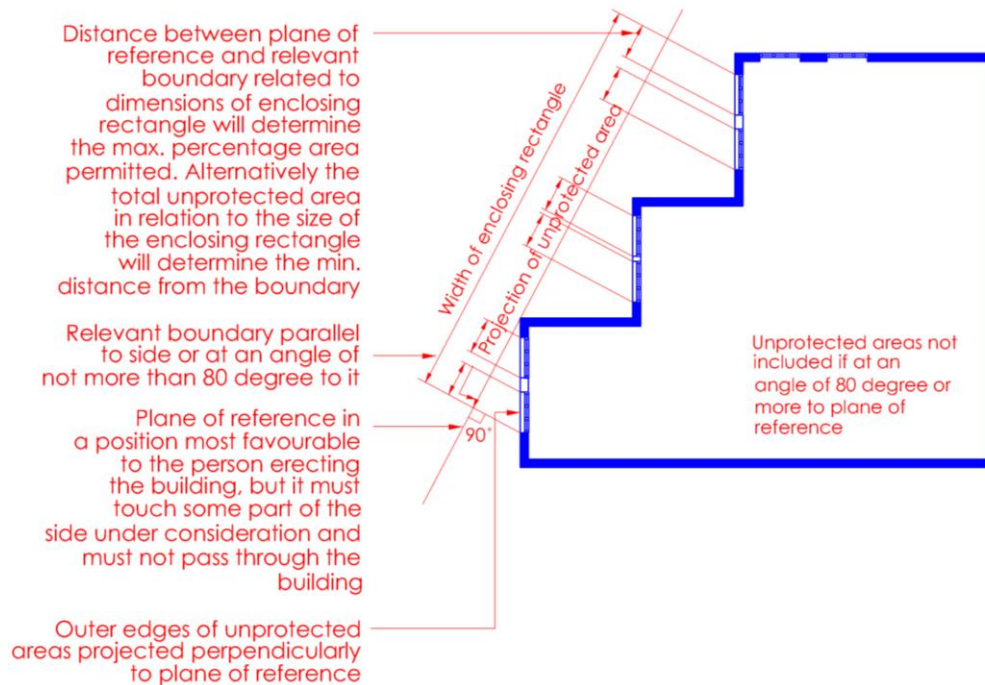
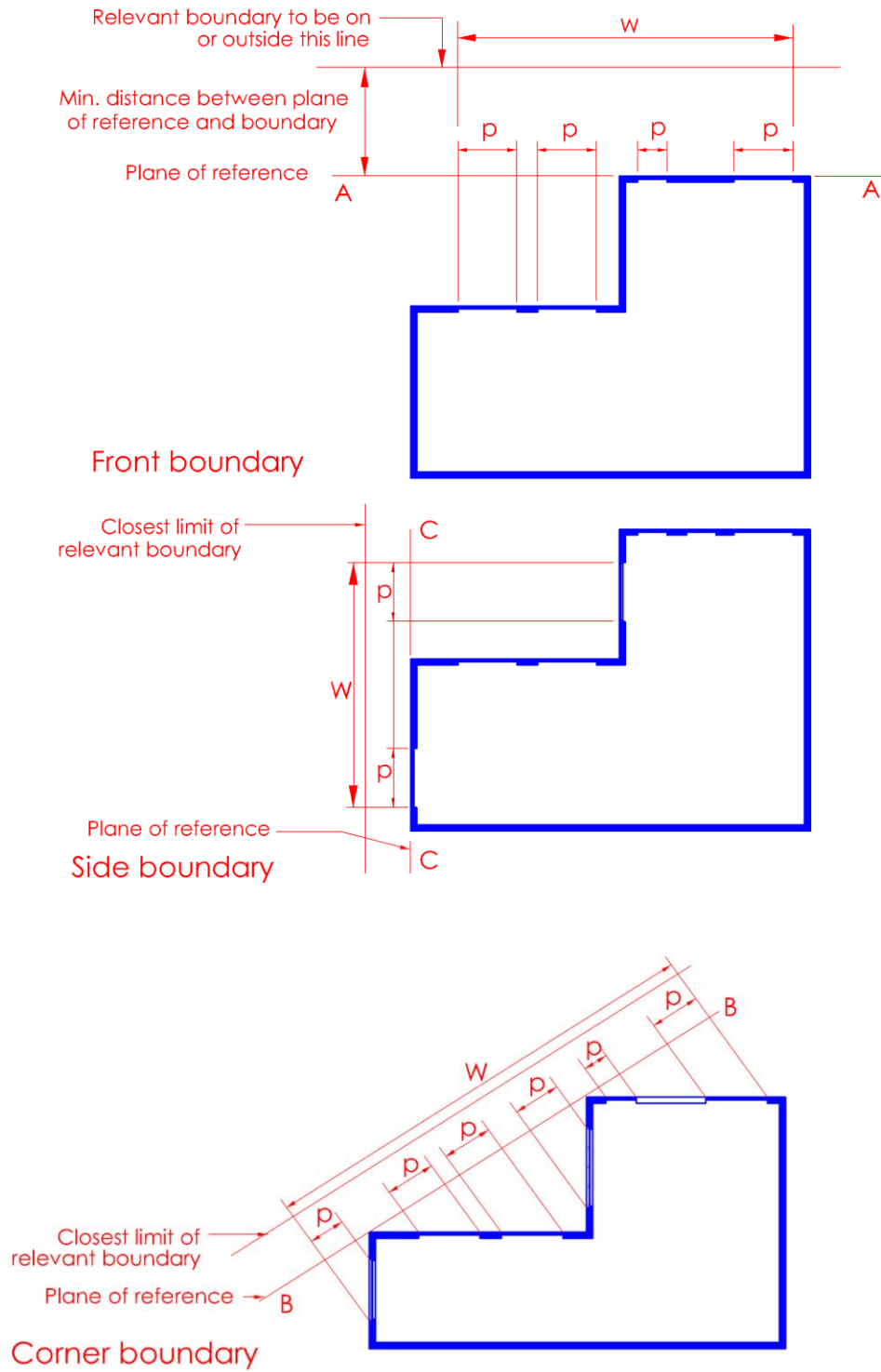

Diagram 4 – (1) Pt. II Appendix B

**Relevant boundaries** – where the side of a building is on the boundary, that is the ‘relevant boundary’. Otherwise it is the actual boundary of the land either parallel to, or making an angle of not more than 80° with the face of the building in question. Note that a boundary can be relevant to more than one face. Where land abuts a road or canal the relevant boundary is taken as the centre of these. The points are illustrated in Cl.1.2.52 in Vol. 1 of the Handbook.





*Diagram 4 – (2) Pt. II Appendix B*

Plane of reference to more than one face of a building

Lines A – A, B – B & C – C represent the plane of reference.

**Plane of reference** – A plane of reference has to be established for each side of the building which faces a boundary. This is a vertical plane which touches, but does not pass through the building (except for such projections as bay windows, balconies, cornices etc), nor does it cross the boundary (known as the “relevant boundary”). It must not make an angle of more than 80° with the side of the building.

It will usually (but not always) be appropriate for it to be parallel to the boundary and in many cases it will coincide with the face of the building. On to this all the unprotected areas facing the boundary are projected at right angles, but excluding any that are set at an angle of more than 80° to the plane. It is quite possible for a plane of reference to take in more than one side of a building.

**Enclosing rectangle**

A rectangle is constructed on the plane of references so as to enclose the outer limits of all the unprotected areas on that side of the building or compartment. The enclosing rectangle is the smallest rectangle which would :

- (a) enclose the outer edges of any unprotected areas;
- (b) have two horizontal sides; and
- (c) have height and width falling within those listed in Tables 1 and 2

**Unprotected percentage**

This is established by taking the aggregate area of all the unprotected areas (see diagram above) as percentage of the area of the enclosing rectangle.

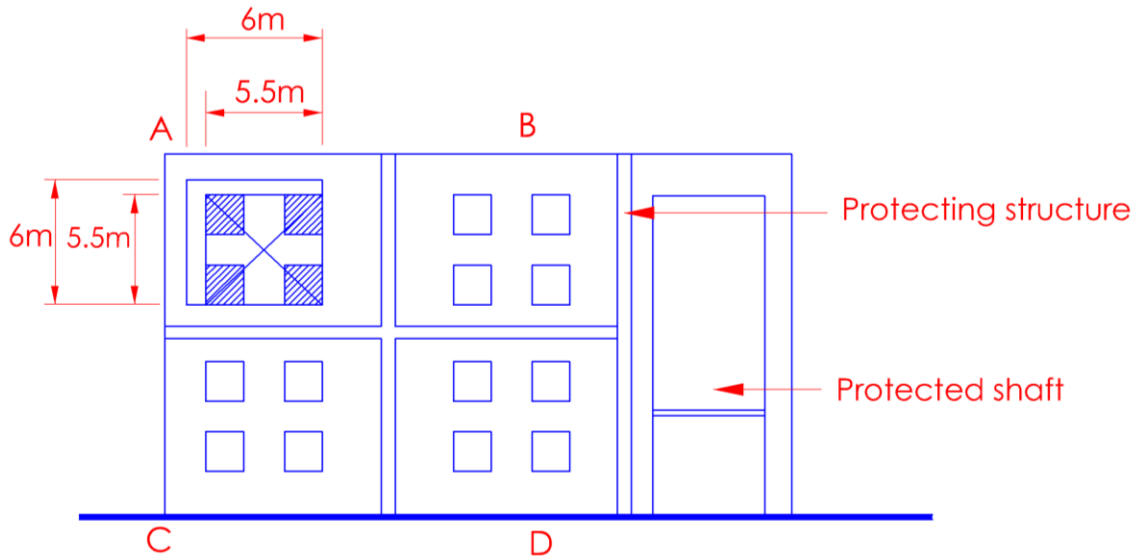
*Example on calculations on unprotected areas*A Example on calculations of unprotected openings/separation distance requirements for apartment unit

For apartment building, each unit is a compartment as shown in above diagram (compartments A, B, C and D). It is assumed that the relevant boundary is parallel with the face of the building. For calculating the unprotected areas, each compartment can be taken separately, usually the one with the most unprotected areas.

1. Assume rectangle (enclosing unprotected areas) = 5.5m x 5.5m
2. To use the nearest corresponding enclosing rectangle from Table 1, of Fire Code, enclosing rectangle = 6m x 6m = 36sq m
3. Assume unprotected areas = 14.4sq m
4. Unprotected percentage (unprotected areas as percentage of enclosing rectangle)
  - = 14.4sq.m as percentage of 36sq.m
  - = 46% use 40% column in Table 1
5. From table 1 distance from boundary = 2m (minimum)

Footnote: By interpolation between 40% and 50% column, the separation distance would be 2.25m, which is acceptable.

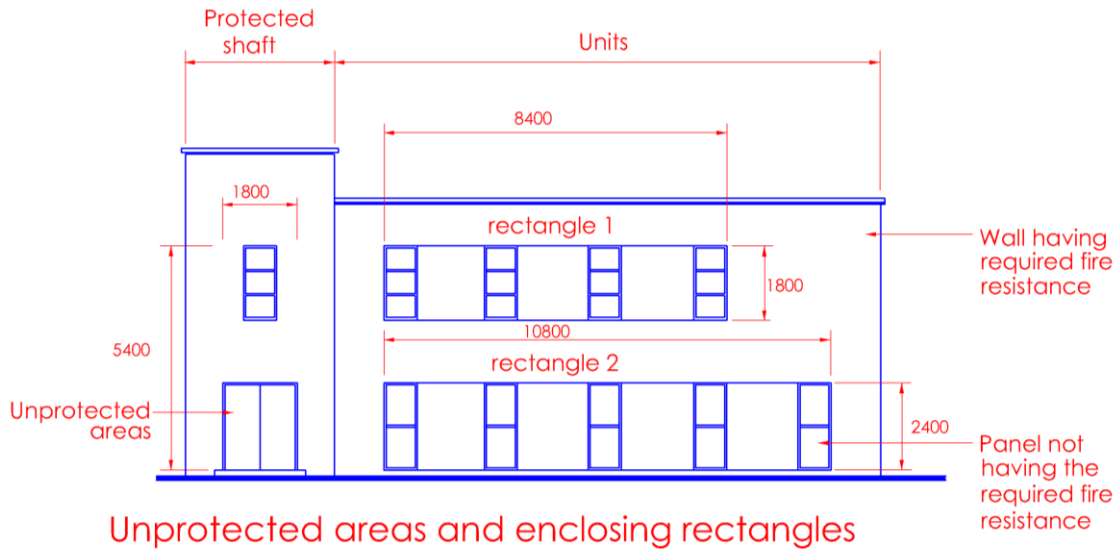

Unprotected areas and enclosing rectangles

Diagram 4 – (3) Pt.II Appendix B

Unprotected percentage

This is established by taking the aggregate area of all the unprotected areas (see diagram above) as percentage of the area of the enclosing rectangle.

Example on calculations on unprotected areas

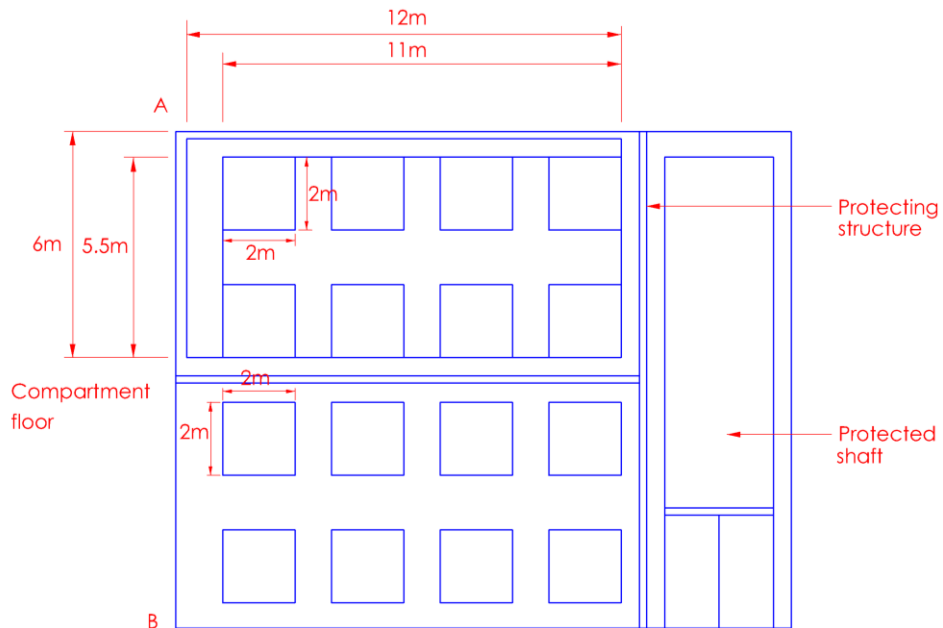

(b) Compartmented  
(assume compartmentation as shown)

*Each storey is a compartment as shown in above diagram (compartments A & B). It is assumed that the relevant boundary is parallel with the face of the building. For calculating the unprotected areas, each compartment can be taken separately, usually the one with the most unprotected areas. As both compartments have the same unprotected openings, only one is taken for the calculations.*

- 1. Assume a rectangle (to enclose all relevant unprotected areas) = 5.5m x 11m*
- 2. The rectangle formed under (1) is to be converted to enclosing rectangle. Thus to use the nearest corresponding enclosing rectangle from Table 1, of current Fire Code, enclosing rectangle = 6m x 12m = 72sq m*
- 3. Unprotected areas = 32sq m (2 x 2 x 8 nos) – not relevant openings under 2(b) of Appendix B to Cl.3.5 Pt 1 are excluded e.g. openings less than 0.1m<sup>2</sup> and located more than 1.5m from other unprotected opening; openings to protected shaft*
- 4. Unprotected percentage (unprotected areas as percentage of enclosing rectangle)  
= 14.4sq.m as percentage of 36sq.m  
= 46% use 40% column in Table 1*
- 5. Table 2 distance from boundary = 4m (minimum)*

*Footnote: Interpolation is permissible. By interpolating between 30% and 40%, it works out to be 4.6m.*



***Example 1 – Applying the 2-dimensional geometry to compute building setback for openings that directly face the reference plane***

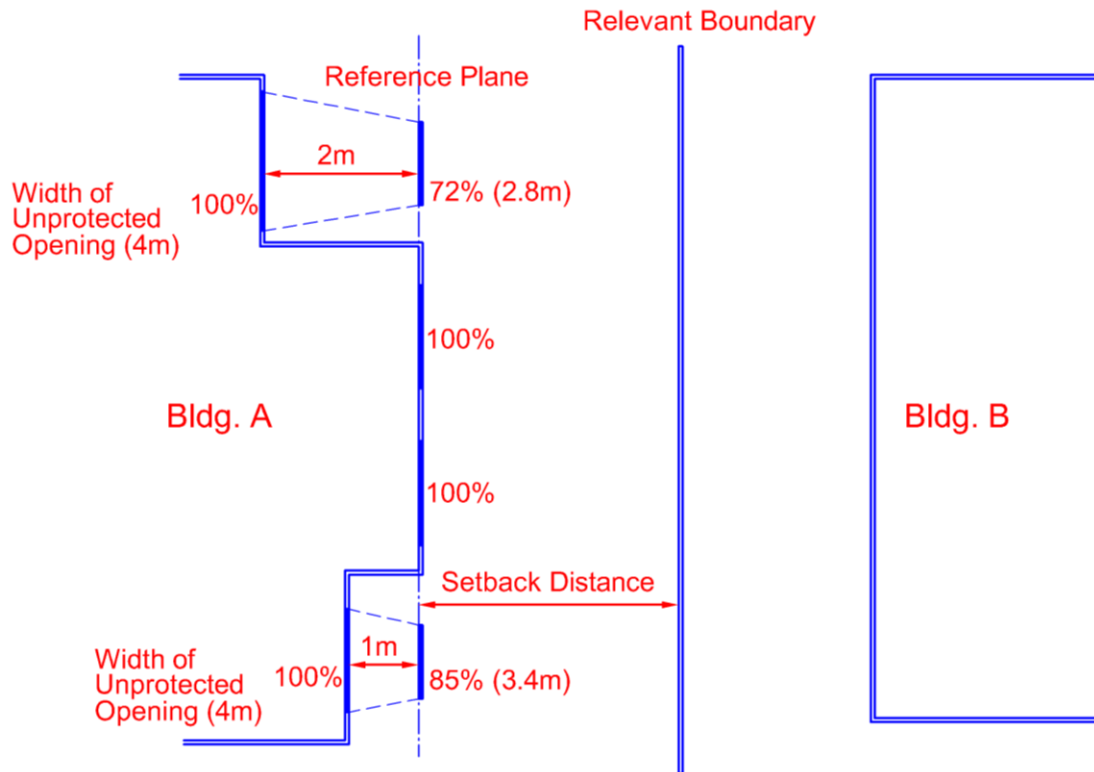

**Diagram showing the reduction in the width of the unprotected opening when projected to the reference plane**

**Step 1.** Determine the width reduction in unprotected opening due to its distance from the unprotected opening to the reference plane using Table 3. In this example, the width of the unprotected openings is 4m and their distances to the reference plane are 2m and 1m respectively. As there is no 4m unprotected width in Table 3, the next higher figure of 6m is used. From the table, the actual unprotected opening width is 72% of the original width of 4m i.e. 2.9m at the reference plane for the opening that is 2m from the reference plane and 85% of the original width of 4m (i.e. 3.4m at the reference plane for the opening that is 1m from the reference plane (see diagram above).

**Step 2.** After all the unprotected openings are projected onto the reference plane, the existing approach highlighted in Annex A1 is used to compute the building setback.

**Note:** When making reference to Table 3, a building designer shall always take the next higher figure for the width of the unprotected opening or its distance to the reference plane when these are not reflected in the table. Interpolation is not allowed as the figures in the table do not follow a linear regression.

***Example 2 – Applying the 2-dimensional geometry to compute building setback for openings at an angle to the reference plane***

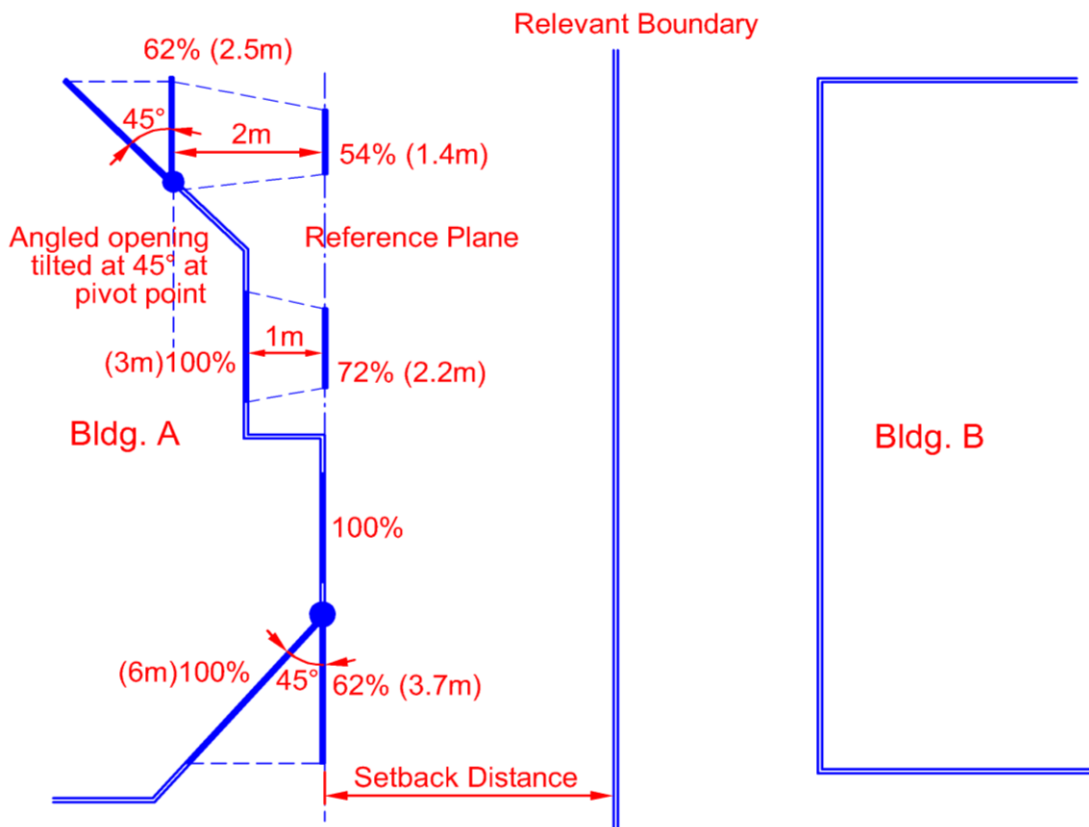

**Diagram showing the reduction in width of the unprotected opening when tilted to directly face the reference plane.**

**Step 1.** Determine the width reduction of the angled unprotected opening when it is tilted to directly face the reference plane using Table 4. In this example, there are two 45° angled planes of 4m and 6m width. From the table, the actual unprotected opening width is 62% of the original widths of 4m and 6m. Therefore, the widths of the openings facing the reference plane are 2.5m and 3.7m respectively. As the unprotected opening 2.5m width is still at a distance to the reference plane, its width can be further reduced using step 2.

**Step 2.** Determine the width reduction in unprotected opening due to its distance from the unprotected opening to the reference plane using Table 3. In this example, the widths of the unprotected opening are 2.5m & 3m and their distance to the reference plane are 2m and 1m respectively. As there is no 2.5m unprotected opening width in Table 3, the next higher figure of 3m is used. From the table, the actual unprotected opening widths are 54% and 72% of the original widths of 2.5m and 3m respectively. Therefore, the widths of the unprotected openings facing reference plane are 1.4m and 2.2m respectively.

**Step 3.** After all the unprotected openings are protected onto the reference plane, the existing approach highlighted in Annex 1 is used to compute the building setback.

**Note:** When making reference to Table 4, a building designer shall always take the next higher figure for the width of the unprotected opening or its distance to the reference plane when these are not reflected in the table. Interpolation is not allowed as the figures in the table do not follow in linear regression.

# CHAPTER 3

## 3.5 EXTERNAL WALL

<b>3.5.5 Reference to Part I - II of Appendix B</b>	
---	--

Any reference to Appendix B shall be construed as referring to the provisions of Part I of that Appendix together with the provisions of Part II.
---

<b>EXPLANATIONS &amp; ILLUSTRATIONS</b>	
---	--

*No illustration.*

# CHAPTER 3

## 3.5 EXTERNAL WALL

### 3.5.6 Buildings on land in common occupation

If two or more detached buildings are erected on land in common occupation, any external wall of any building so erected which faces an external wall of such other building, the relevant boundary shall be a notional boundary passing between those buildings and such boundary must be capable of being situated in such a position as to enable the external walls of those buildings to comply with the requirements of Cl.3.5.3.

### EXPLANATIONS & ILLUSTRATIONS

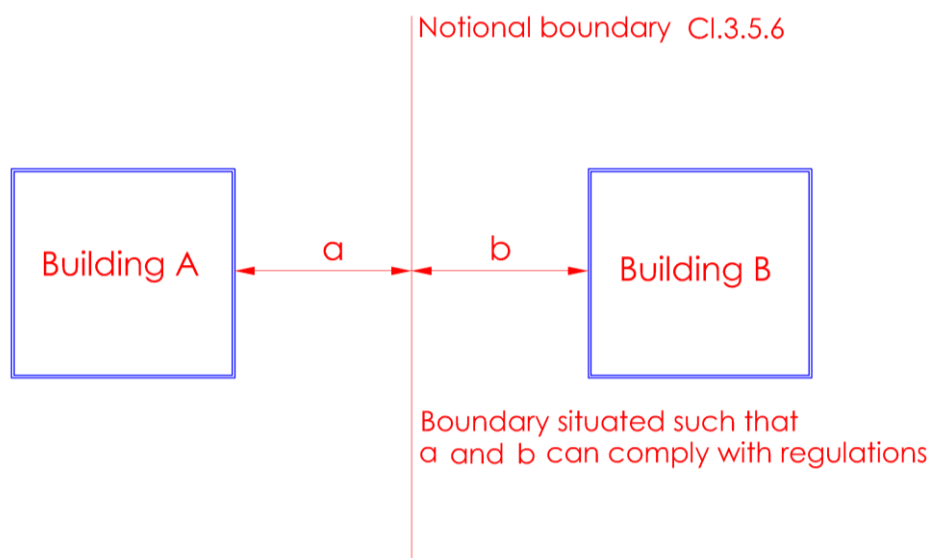

Diagram 3.5.6(a)

- (a) *It is necessary to assume a notional boundary when two or more detached buildings are erected on land in common occupation.*
- (b) *The notional boundary is taken to exist in space between the buildings and is positioned so that the external walls of building A and B facing the notional boundary comply with the separation distance requirement in accordance with Tables of Appendix B, based on the percentage of unprotected area and the purpose group of the compartment/floor.*
- (c) *Unprotected openings shall be assessed for each building separately. The separation distance between the two buildings shall be not less than the sum of the distance each building would require to a relevant boundary i.e. “a” is equal to or greater than the separation distance to the boundary for building A and “b” is equal to or greater than the separation distance to the relevant boundary for building B.*
- (d) *The notional boundary can be shifted next to external wall of building A or B, if the external wall has no unprotected areas and is constructed of non-combustible materials having the requisite period of fire resistance rating as the elements of structure of the storey compartment.*

# CHAPTER 3

## 3.5 EXTERNAL WALL

### 3.5.7 Vertical fire spread

For high and low parts of different compartments of a building abutting each other, either one of the following requirements shall be complied with to prevent spread of fire from the roof close to and lower than the external of the higher part:

- (a) the roof over the lower part of the building shall be fire rated in accordance with the element of structure for minimum 1 hour for a distance of 5m measured horizontally from the external wall of the higher part of building; or
- (b) the external wall of the higher part of the building overlooking the roof below shall have the necessary fire resistance rating in accordance with the element of structures for minimum 1 hour for a vertical height of not less than 9m measured from the roof of the lower part of the building.
- (c) the above requirements shall not be applicable to buildings or lower parts of the building which are sprinkler protected, or old shophouses which are subject to URA's Conservation Programme or built before 1969 referred to under Cl.1.1.1.1 and Cl.1.1.1.2

### EXPLANATIONS & ILLUSTRATIONS

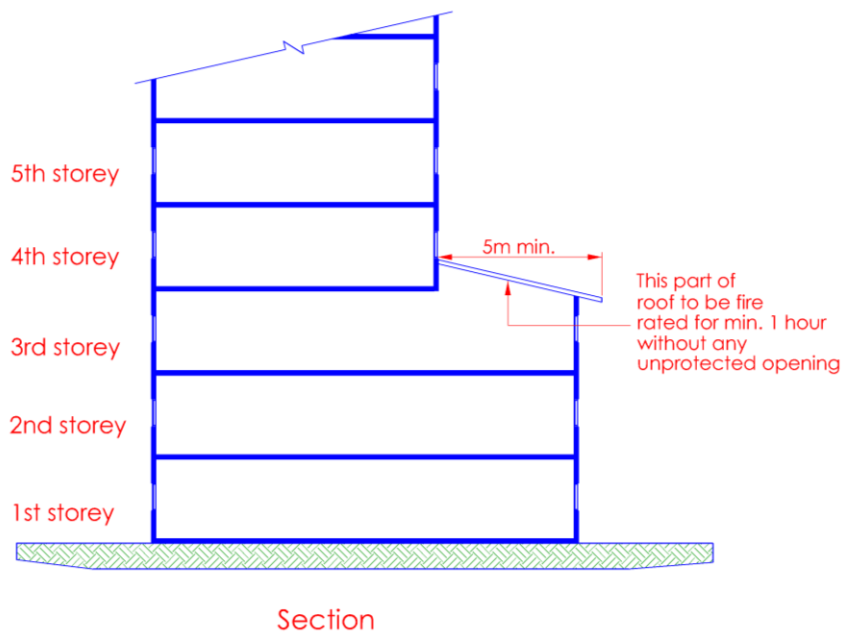

Diagram 3.5.7(a)

*The entire roof projection over the lower part of the building if less than 5m, then the entire roof projection shall be fire rated with minimum 1 hour fire resistance rating. A fire occurring in the 3<sup>rd</sup> storey would spread vertically to 4<sup>th</sup> storey via the roof and windows. To prevent the fire spread vertically, the roof of 3<sup>rd</sup> storey should be fire rated for min. 1-hour for a distance of 5m measured horizontally from the external wall of 4<sup>th</sup> storey abutting the roof of 3<sup>rd</sup> storey. The above requirement to fire rate the roof of 3<sup>rd</sup> storey will not be applicable if the building or lower part of the building is sprinklered protected.*

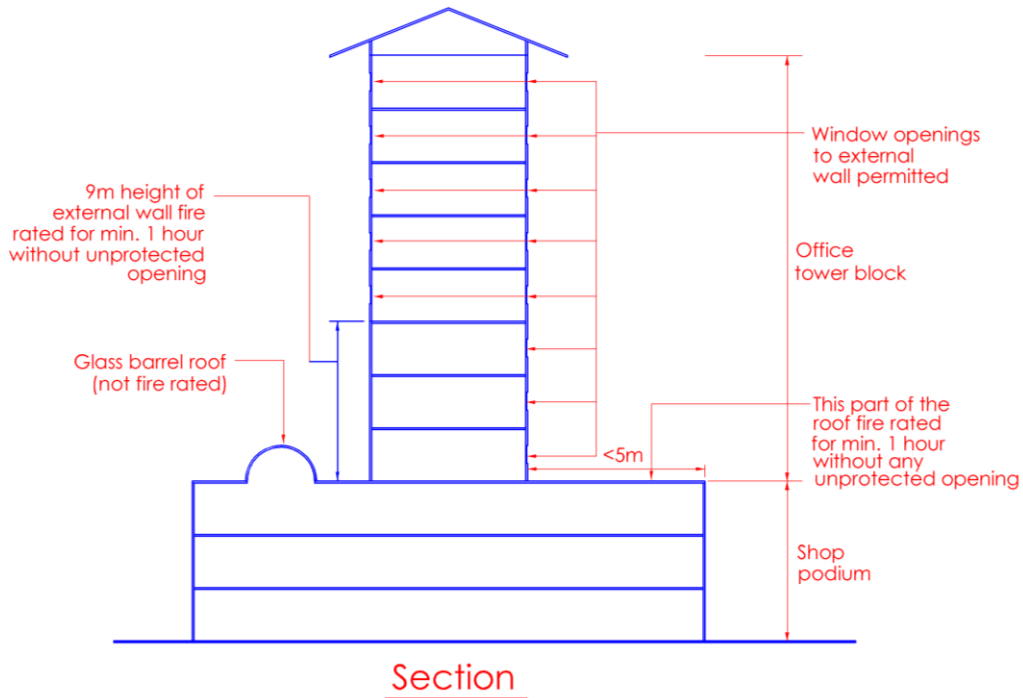

Diagram 3.5.7(b)-1

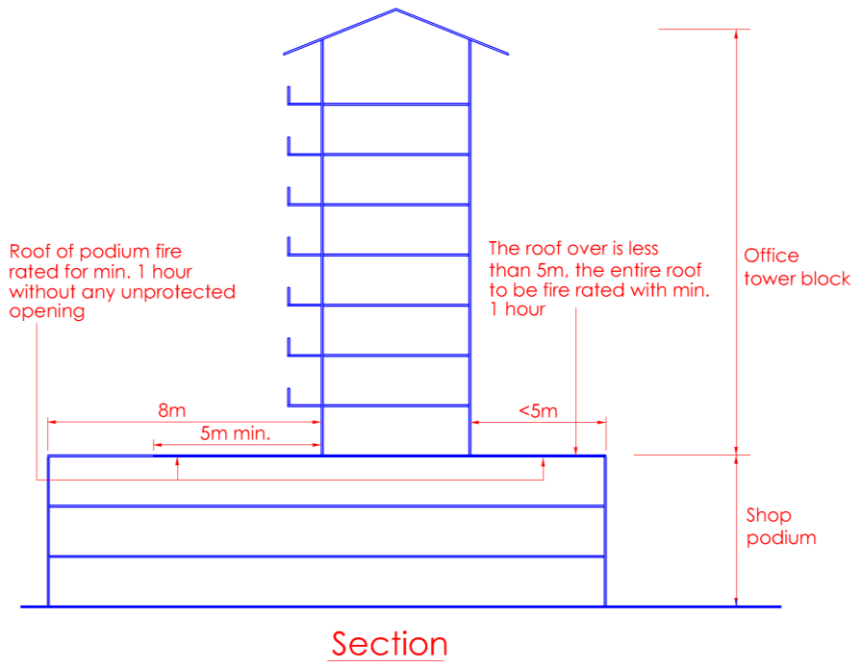

Diagram 3.5.7(b)-2

Providing fire rated wall with unprotected opening is an alternative to fire rating the roof under sub-clause (a).

The above 2 diagrams show the 2 ways of preventing fire spread vertically from the lower floor to the upper floors.

# CHAPTER 3

## 3.6 SEPARATING WALL

### 3.6.1 Requirements of separating walls

Every separating wall shall:

- (a) Form a complete barrier in the same continuous vertical plane through the full height between the buildings it separates, including roofs and basements and shall be imperforate except for provisions of openings permitted under Cl.3.6.2, and
- (b) Have the appropriate fire resistance to comply with the requirements of Cl.3.3, and
- (c) Be constructed of non-combustible materials, together with any beam and column which form part of the wall and any structure which it carries.
- (d) Not include glass fire resisting walls.
- (e) Exception  
Subclause (a) need not be applied to wall between car porches of buildings under purpose group I. For terrace-housing situation, this exception will not apply if the carporch is spanning from one side boundary to the other.

### EXPLANATIONS & ILLUSTRATIONS

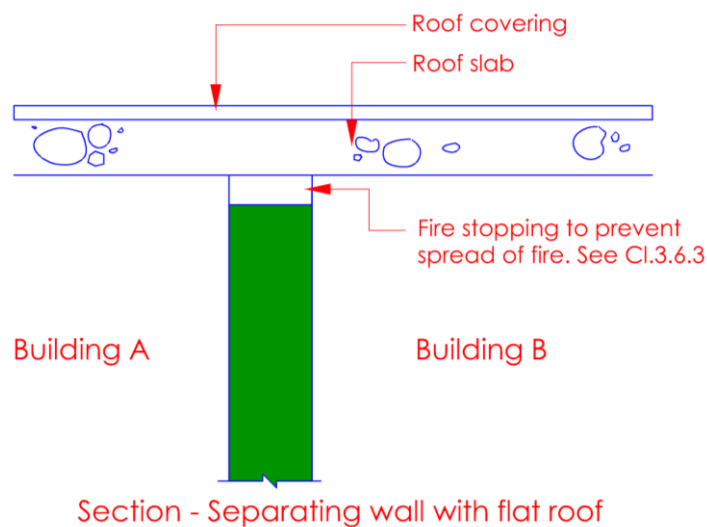

Diagram 3.6.1(a)

*Separating wall is the common wall that separates one house from another, as in the case of semi-detached or terraced houses. It is to prevent the spread of fire from house to house. The separating wall shall have the appropriate fire resistance rating as the elements of structure of the adjoining house having the larger floor area or cubical extent as the case may be. It shall not include fire resisting glass.*

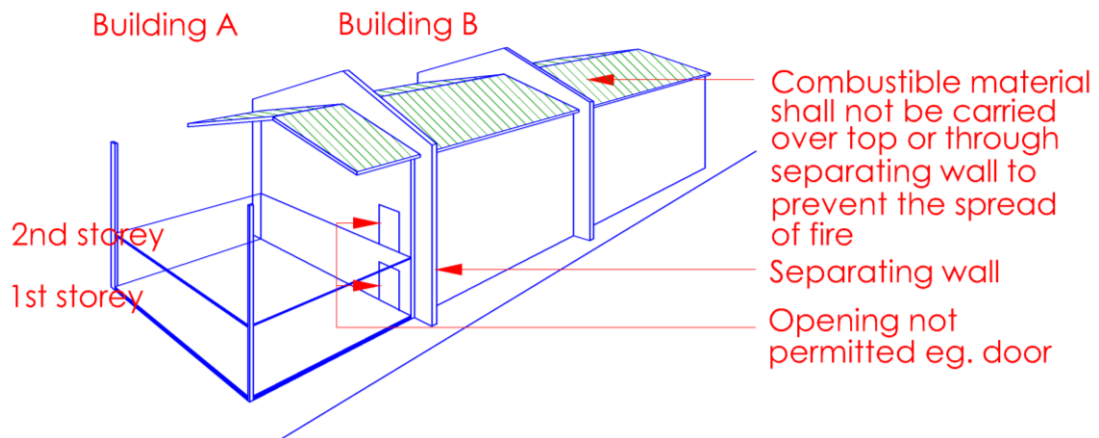
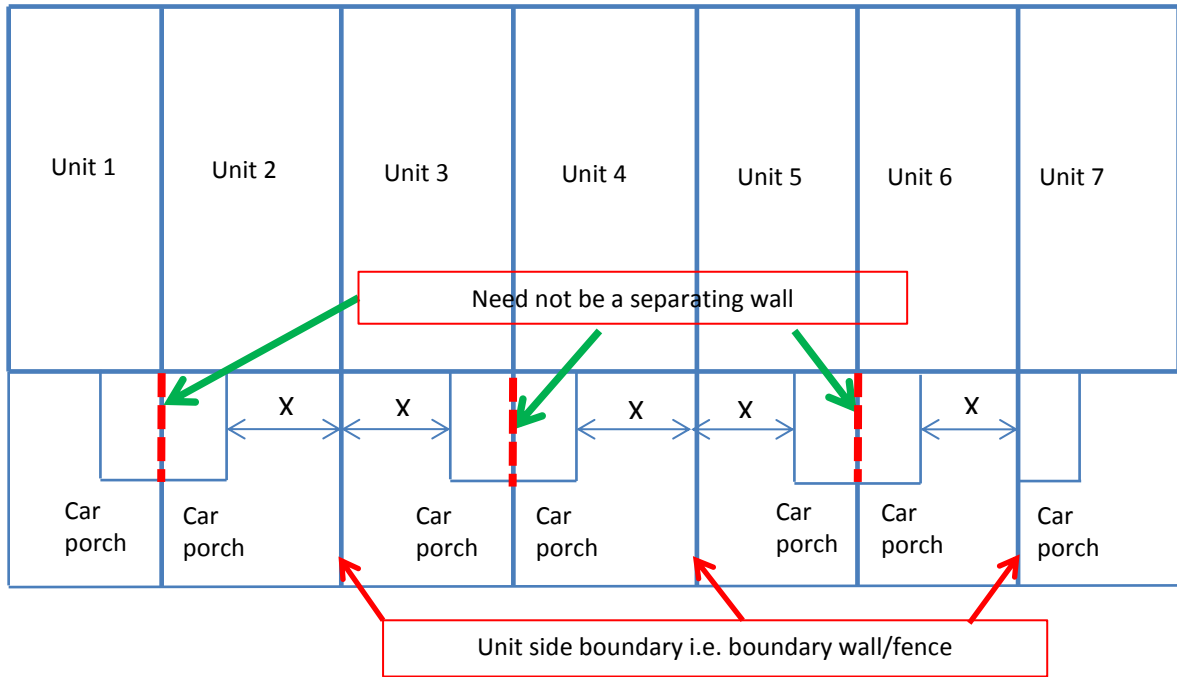

Diagram 3.6.1(b)

Separating wall with pitched roof

*Door opening in the separating wall is to provide communication between 2 houses is not acceptable, unless the 2 houses are under single ownership and occupied by single family. Owner is required to furnish an undertaking to FSSD that should one of the houses is to be sold, the door opening in the separating wall shall be bricked-up to have the necessary fire resistance as the adjoining wall.*





Scenario 1

*Walls between car porches (annotated by dash line) need not be separating walls provided the car porches are set back (annotated as 'x' above) adequately from their respective unit side boundaries.*

*Diagram 3.6.1(c)-1*

## EXPLANATIONS & ILLUSTRATIONS

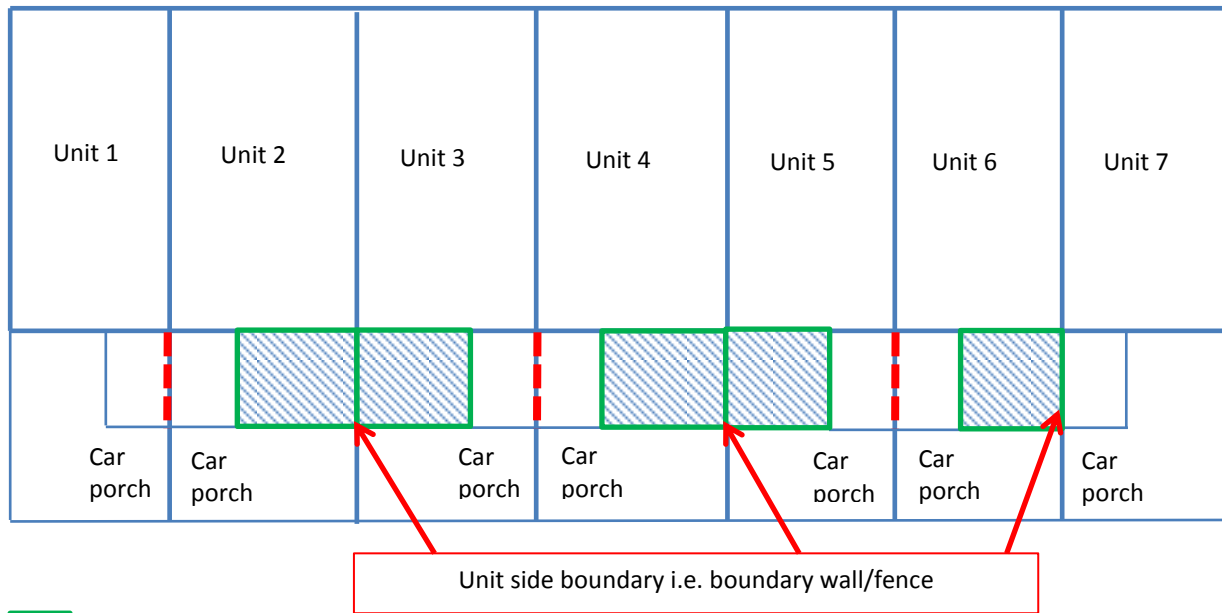

 Canopy extended from car porch

Diagram 3.6.1(c)-2

### Scenario 2

*Walls between car porches need to be separating walls (annotated by dash line) if the canopies span across the car porches and unit side boundaries.*

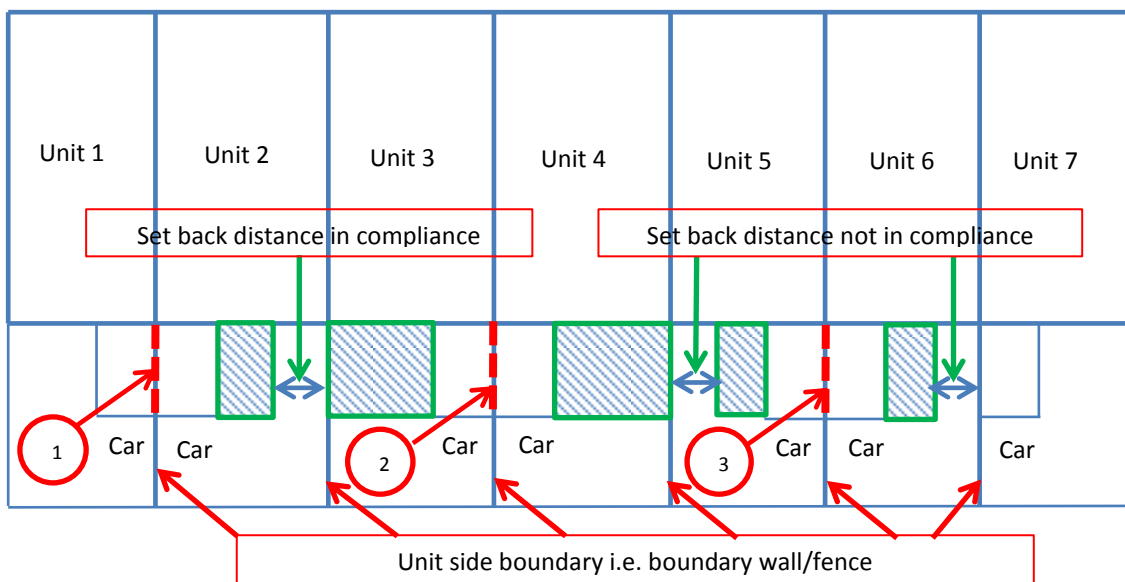

Diagram 3.6.1(c)-3

### Scenario 3

*Boundary no. 1 need not be a separating wall if the extended canopy can comply with set back to the unit side boundary as reflected above. Conversely, boundary nos. 2 & 3 need*

*to have separating walls since the extended canopies cannot comply with set back from their respective side boundaries.*

# CHAPTER 3

## 3.6 SEPARATING WALLS

### 3.6.2 Openings in separating walls

A separating wall shall have no openings except for –

- (a) A door required to provide a means of escape in the event of a fire, having the same fire resistance as that required for the wall and complying with Cl.3.9.2, or
- (b) A door provided for the purpose of public circulation and permitted by the Relevant Authority, having the same fire resistance as that required for the wall and complying with Cl.3.9.2, or
- (c) Opening for the passage of a pipe complying with the relevant provisions of Cl.3.9.3.

### EXPLANATIONS & ILLUSTRATIONS

*(No illustration, see diagram 3.6.1(b))*

*Opening in the separating wall shall comply with the following conditions :*

- i) QP shall obtain prior approval from FSSD before submission of building plan.*
- ii) If the adjoining unit or building is under different ownership; written consent from the owner shall be obtained for submission to FSSD.*
- iii) Owner is to submit a written undertaking to FSSD that should the opening in the separating wall is no longer required, it shall be restored to its original imperforate state.*

*Sub-clause (b) is not applicable to Purpose Group VI & VIII.*

- (a) Door opening between 2 industrial units is not acceptable, unless the units are owned by one owner and occupied by a single company. In such a case the door opening in the separating wall shall be used solely for providing communication between the units and shall not be taken as means of escape during fire emergency, unless otherwise allowed. The owner is to furnish an undertaking to FSB that should one of the units be sold, the door opening in the separating wall shall be bricked-up to have the necessary fire resistance as the adjoining wall.*

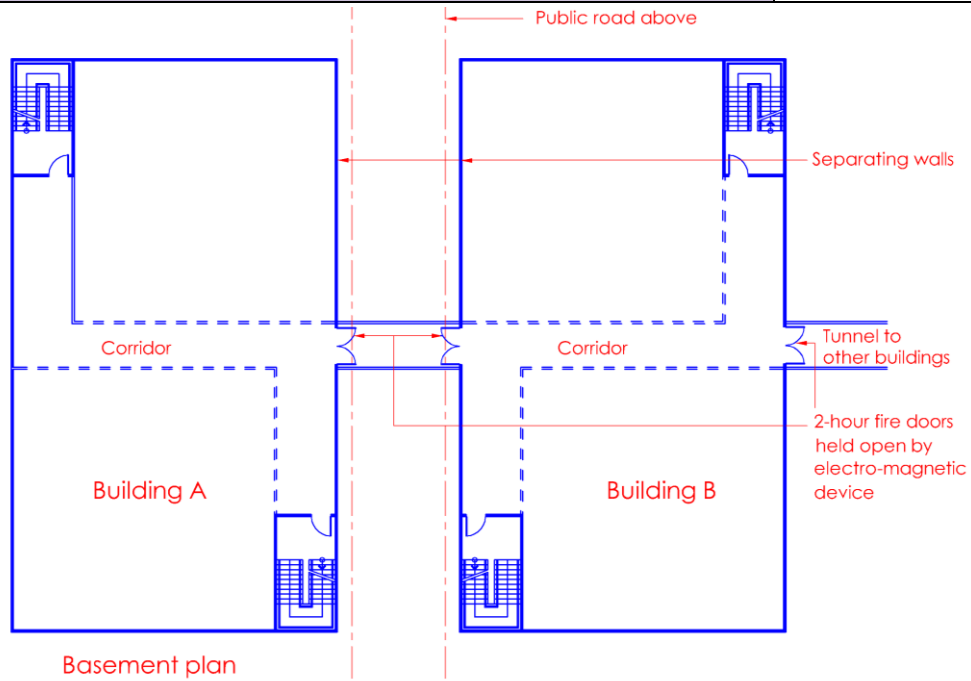

*Diagram 3.6.2(b)-1*

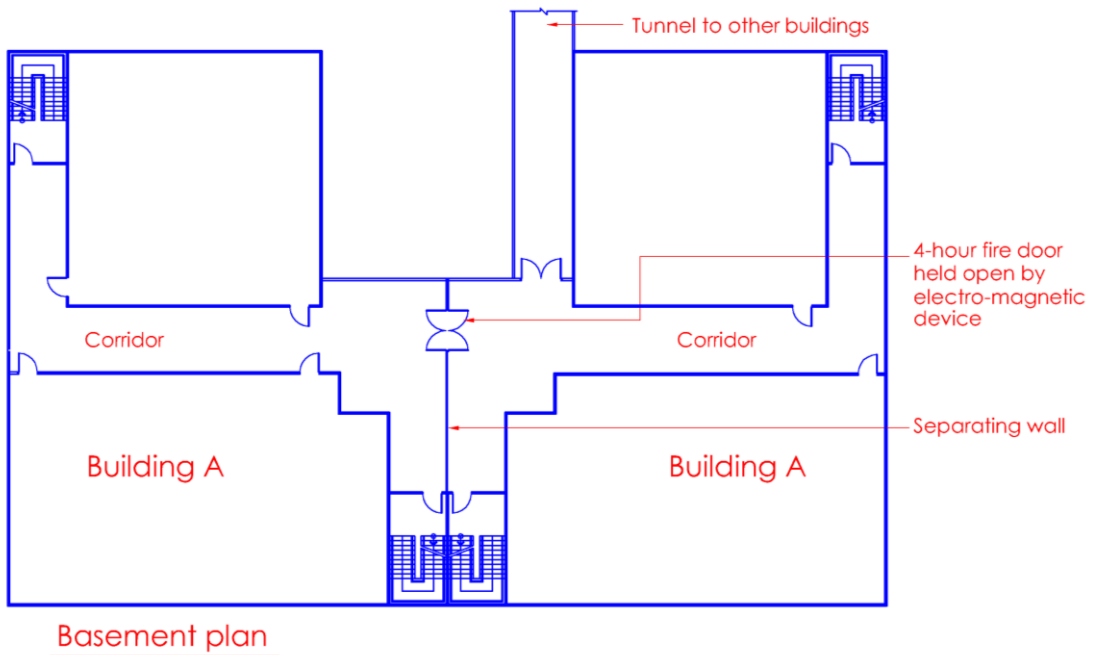

*Diagram 3.6.2(b)-2*

*Doors are provided in separating walls to connect 2 buildings for public circulation. Prior approval shall be obtained before building plans are submitted for approval. The above provision for the purpose of public circulation shall not be taken to qualify for the requirements for the provision of area of refuge.*

# CHAPTER 3

## 3.6 SEPARATING WALLS

### 3.6.3 Separating wall - roof junction

A separating wall shall be either carried up to form a close joint with the underside of a pitched roof of non-combustible covering or carried up above the level of such roof covering. The junction between such separating wall and roof shall be properly fire-stopped so as not to render ineffective the resistance of such separating wall to the effects of the spread of fire

### EXPLANATIONS & ILLUSTRATIONS

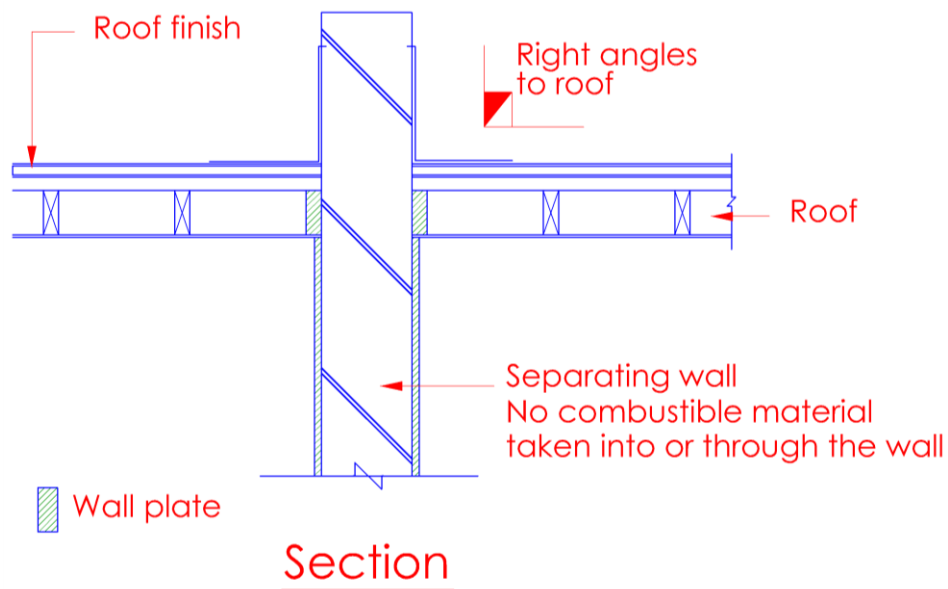

Diagram 3.6.3

*Separating wall is carried right up above the roof coverings to act as a barrier to prevent fire spread over the roof level. The above clause addresses the concern at the junction of separating walls with roofs and other elements of structure to prevent fire from spreading through cracks and gaps at such junctions.*

# CHAPTER 3

## 3.6 SEPARATING WALLS

### 3.6.4 Separating wall - external wall junction

If any external wall is carried across the end of a separating wall, such external wall and separating wall shall be bonded together or the junction of such walls shall be fire-stopped to comply with the requirements of Cl.3.12.

### EXPLANATIONS & ILLUSTRATIONS

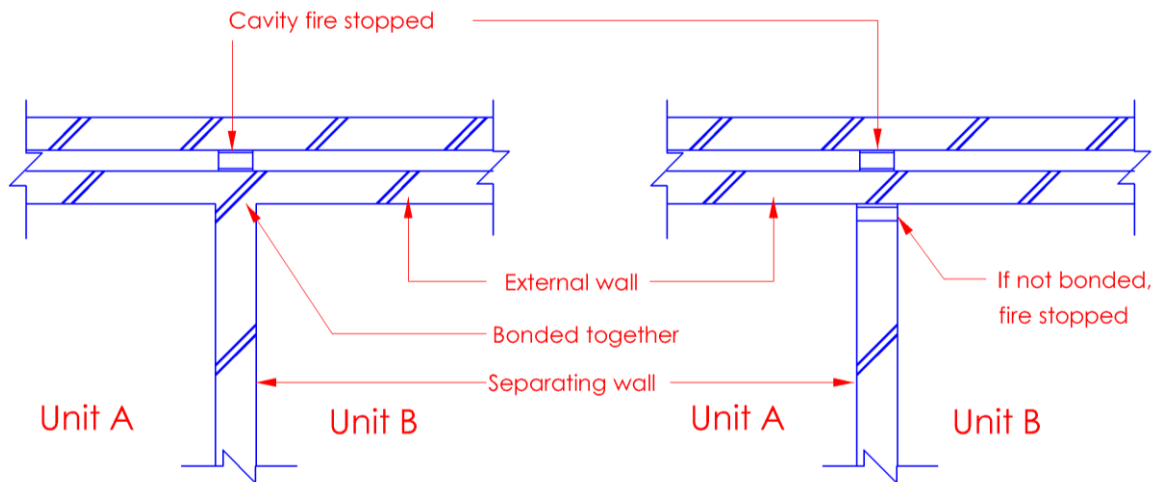

Diagram 3.6.4

# CHAPTER 3

## 3.6 SEPARATING WALLS

### 3.6.5 Prohibition of combustible materials in separating walls

If any external wall is carried across the end of a separating wall, such external wall and separating wall shall be bonded together or the junction of such walls shall be fire-stopped to comply with the requirements of Cl.3.12. No combustible material shall be built into, carried through or carried across the ends of or carried over the top of separating walls in such a way as to render ineffective such separating walls to the effects of the spread of fire.

### EXPLANATIONS & ILLUSTRATIONS

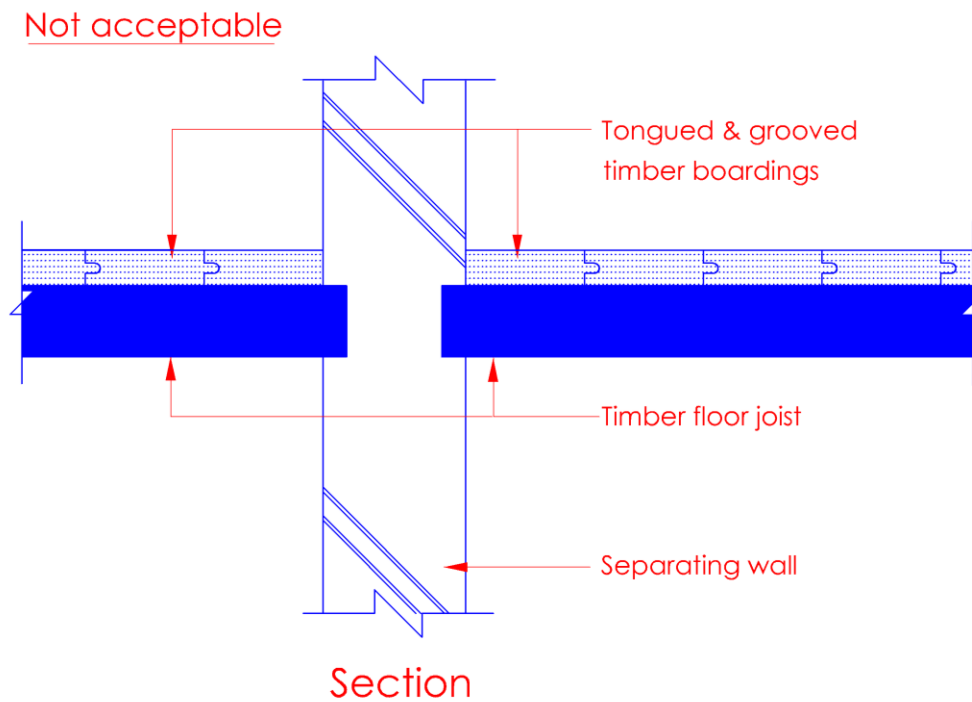

Diagram 3.6.5-(a)



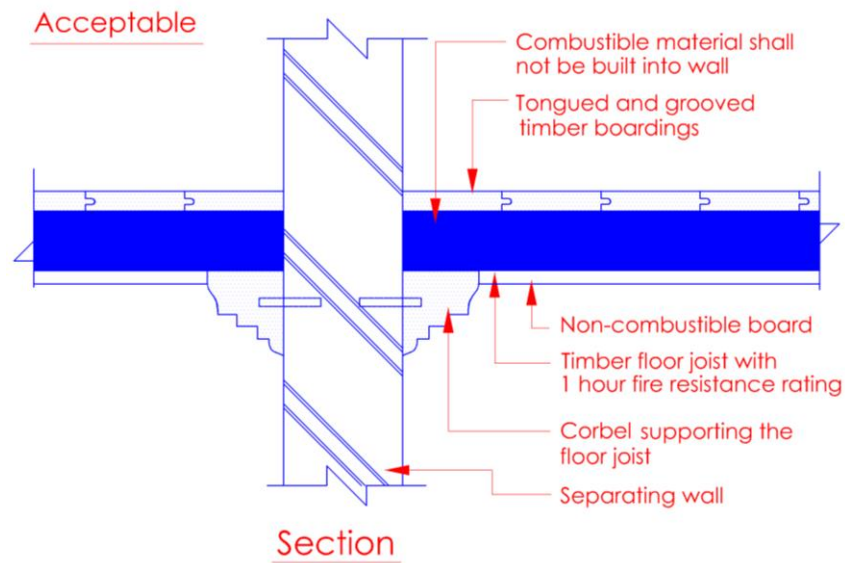

Diagram 3.6.5-(b)

*Combustible materials built into separating wall would weaken the fire resistance integrity of the wall. Separating wall must be constructed of wholly non-combustible materials, including the beam, column or other structure carrying the wall. Exception is allowed for internal linings under Cl.3.13. However, for building under conservation, it would be acceptable if the original method of construction of floor is required to be retained.*

# CHAPTER 3

## 3.7 COMPARTMENT WALLS AND COMPARTMENT FLOORS

### 3.7.1 Requirements of compartment walls or compartment floors

Every compartment wall or compartment floor shall be required to –

- (a) Form a complete barrier to fire between the compartments it separates, and
- (b) Have the appropriate fire resistance to comply with the requirements of Cl.3.3, and
- (c) Be constructed of non-combustible materials (together with any beam or column which forms part of the wall or floor and any structure which it carries), and
- (d) Have no fire resisting glass forming part of it unless permitted under Cl.3.15.13.

### EXPLANATIONS & ILLUSTRATIONS

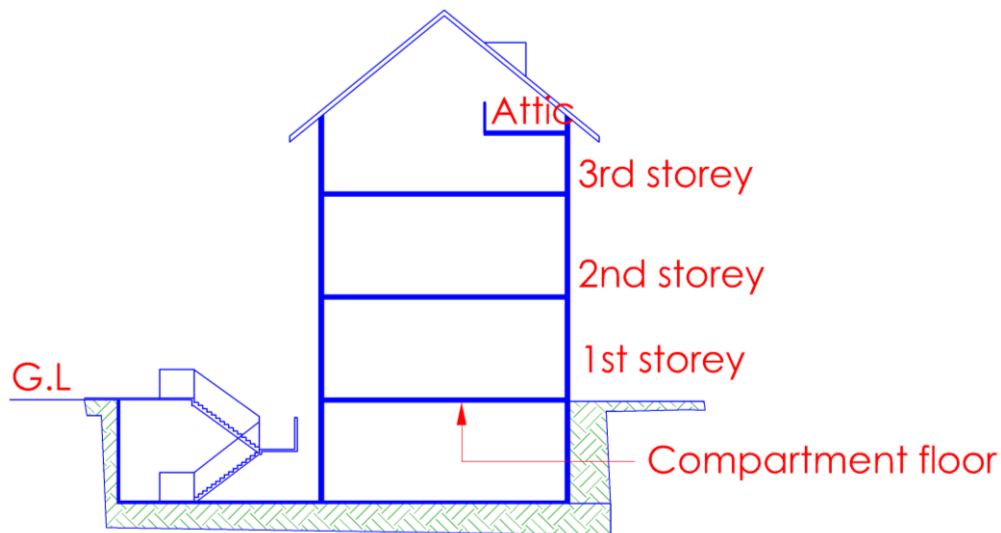

Diagram 3.7.1 – (a)

*The provision of compartment floor would apply to separate basement from upper storeys in the case where the building has 4 or more upper storeys or levels and a basement. Under such situation, Cl.3.2.4(d) shall be complied with i.e. the compartmentation between basement and 1<sup>st</sup> storey shall not be penetrated by any openings or services even if :*

- (i) *such openings are provided with fire doors; and*
- (ii) *the services are in protected shafts.*

*Compartment walls and floors are to be totally imperforated except for the following permitted openings :*

- (a) doors*
- (b) protected shafts*
- (c) ventilation ducts*
- (d) pipes*
- (e) chutes eg. refuse, linen*

*Compartment walls and floors are to be constructed wholly of non-combustible materials, including any beam or column which forms part of the wall or floor and any structure which it carries. The walls and floors shall be constructed to have the necessary fire resistance of min. 1 hour to comply with the requirements of Cl.3.3. See Cl.3.2.5 on the provision of compartment walls and floors to apartment/maisonette unit. Provision of fire resisting glass in compartment wall or floor separating residential units is not allowed.*

# CHAPTER 3

## 3.7 COMPARTMENT WALLS AND COMPARTMENT FLOORS

### 3.7.2 Openings in compartment wall or compartment floor

A compartment wall or compartment floor shall have no openings in it, except for –

- (a) A door which has the same fire resistance rating as the compartment wall and complies with the relevant requirements of Cl.3.4, unless permitted by other provisions of the Code, or
- (b) A protected shaft which complies with the requirements of Cl.3.8, or
- (c) The passage of a pipe or ventilation duct, such openings in the compartment wall or compartment floor shall be protected to comply with the relevant provisions of Cl.3.9.

### EXPLANATIONS & ILLUSTRATIONS

*It is a common practice to provide ½ hour fire resistance entrance door to flat or maisonette from common space, eg lobby. The fundamental reasons are that entrance doors are subject to normal everyday usage and that it is generally accepted that no combustible materials would be placed behind the doors.*

*In other situation, the door within compartment wall shall have the same fire resistance as the compartment wall. This is applicable to trap doors in floors.*

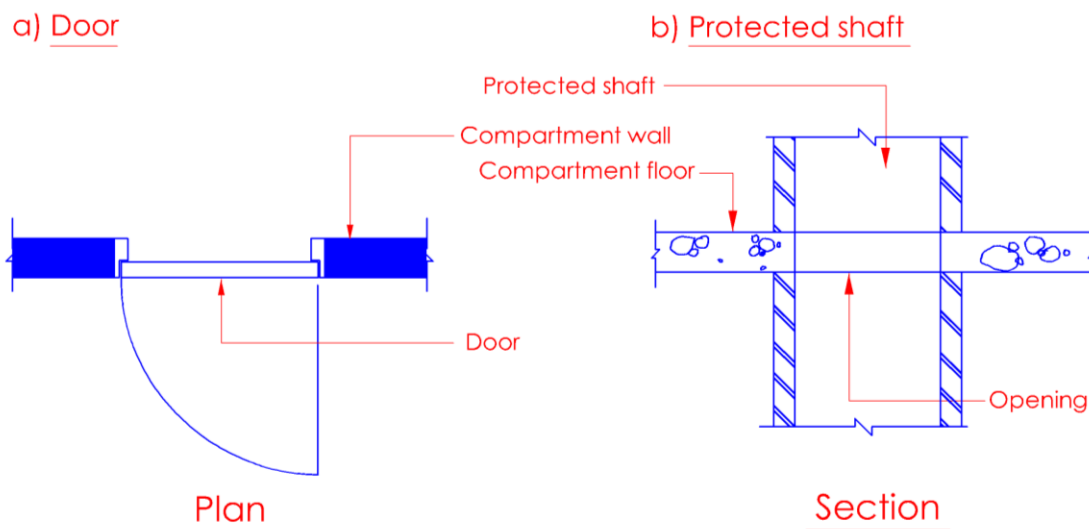

Diagram 3.7.2(a)

Diagram 3.7.2(b)

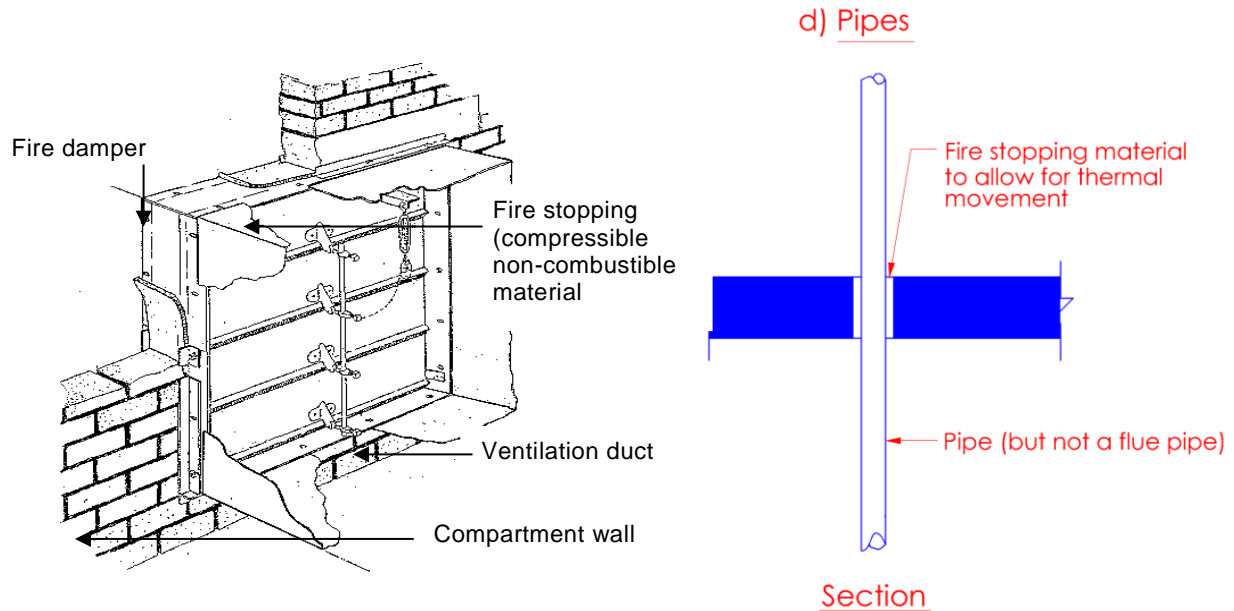

Diagram 3.7.2

Compartment walls and floors are required to be totally imperforated except for the above mentioned openings to permit movement of people, air, services etc in the building.

Other provisions in the code which allow fire door to have  $\frac{1}{2}$  the fire resistance rating of the adjoining compartment wall are :

- (i) Doors to protecting structure under Cl.3.8.6;
- (ii) Exit doors opening into an internal and external exit passageway under Cl.2.3.2(b)(iii) and 2.3.2(c)(iii) respectively; and
- (iii) Exit doors opening into protected lobby under Cl.2.2.13(b).

Doors to protected shafts are required to have  $\frac{1}{2}$  the period of the fire resistance rating of the protecting structure surrounding the opening. The main reasons for the above relaxation are :

- (i) Exit doors if required to have the same period of fire resistance rating as the surrounding wall would be quite heavy. Occupants escaping into the protected staircase would need to push hard to open the doors. Besides having to overcome the weight of the doors, additional force would be required to deal with the self-closing device fitted to the doors and in certain cases, the force imposed by the staircase pressurisation system. This would slow down the evacuation process;
- (ii) A fire that breaks into the shaft at one level would need to break out again at another level. The aggregate rating of the 2 doors, each at different level, would be considered as acceptable.
- (iii) Door openings in protecting structures would be limited in size, hence the potential source of weakness in the overall integrity of the shaft is limited.

In other situation, the door within compartment wall shall have the same fire resistance as the compartment wall. This is applicable to trap doors in floors.

# CHAPTER 3

## 3.7 COMPARTMENT WALLS AND COMPARTMENT FLOORS

### 3.7.3 Junction with other structures

- (a) Where a compartment wall or compartment floor forms a junction with any structure comprising any other compartment wall, or any external wall, separating wall or structure enclosing a protected shaft, such structures shall be bonded together at the junctions or the junctions shall be fire-stopped to comply with the requirements of Cl.3.12.
- (b) The opening occurring at the junction between the edge of a structural floor and the curtain walling shall be sealed to prevent the spread of smoke and flame from the lower floor to the upper floor via the opening. Materials to be used for sealing the opening shall have the requisite fire resistance rating as the elements of structure.

### EXPLANATIONS & ILLUSTRATIONS

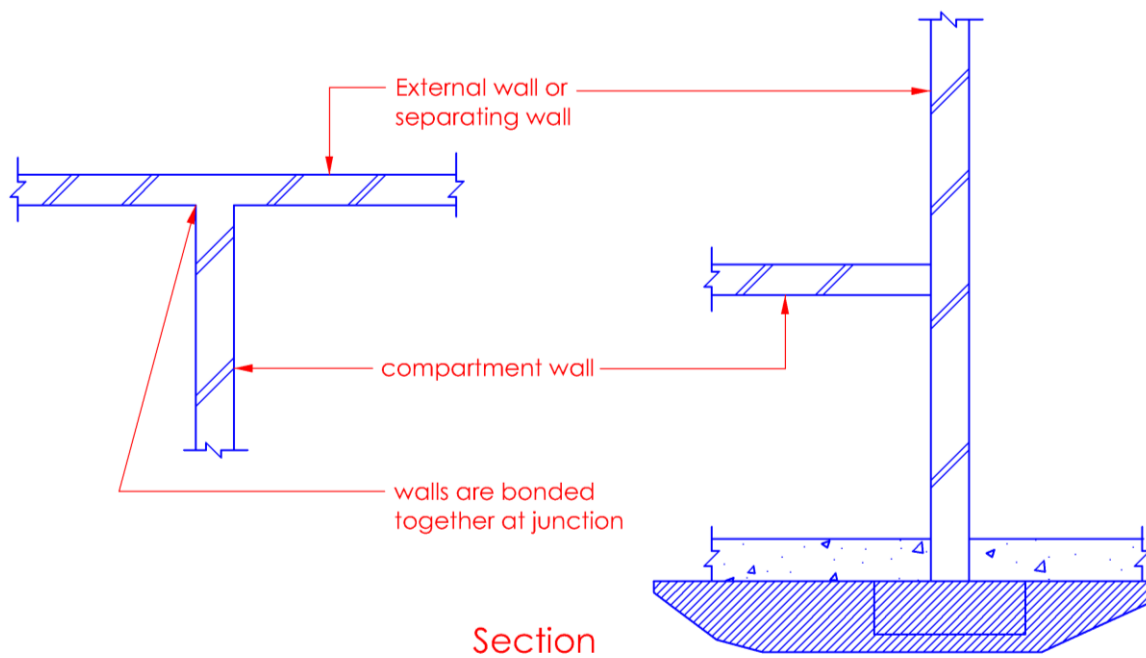
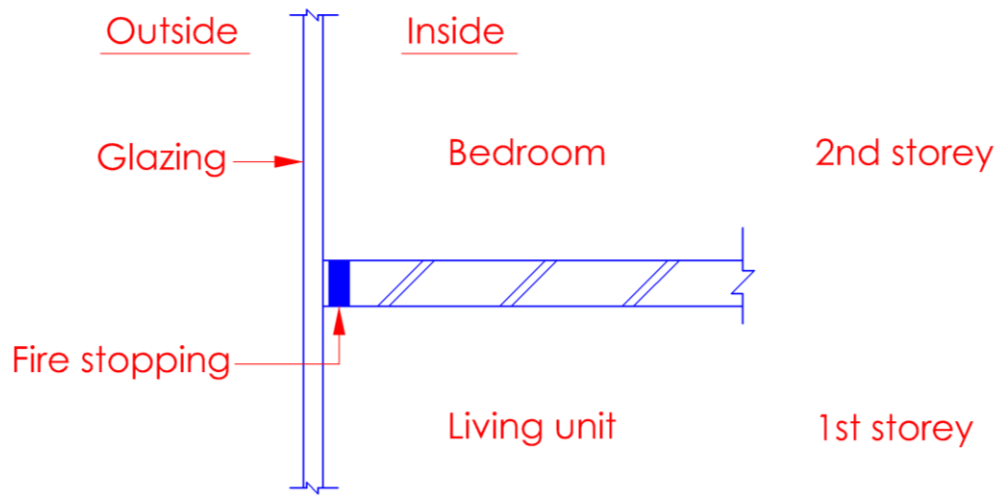

Diagram 3.7.3(a)



Details at junction of curtain walling at floor

Diagram 3.7.3(b)-1

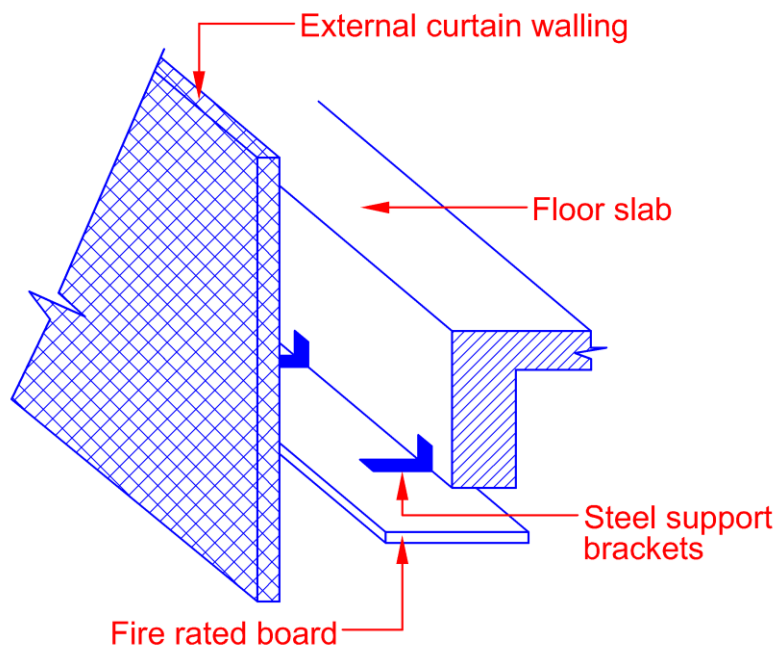

Diagram 3.7.3(b)-2

See subclause 3.6.4 (Separating wall – external wall function)

# CHAPTER 3

## 3.7 COMPARTMENT WALLS AND COMPARTMENT FLOORS

### 3.7.4 Compartment wall – roof junctions

Where a compartment wall forms a junction with a roof, such compartment wall shall be carried up to form a close joint with the underside of the roof and shall be properly fire-stopped or shall be carried up above the level of the roof covering and the junction between such compartment wall and roof shall be properly fire-stopped so as not to render ineffective the resistance of such compartment wall to the effects of the spread of fire.

### EXPLANATIONS & ILLUSTRATIONS

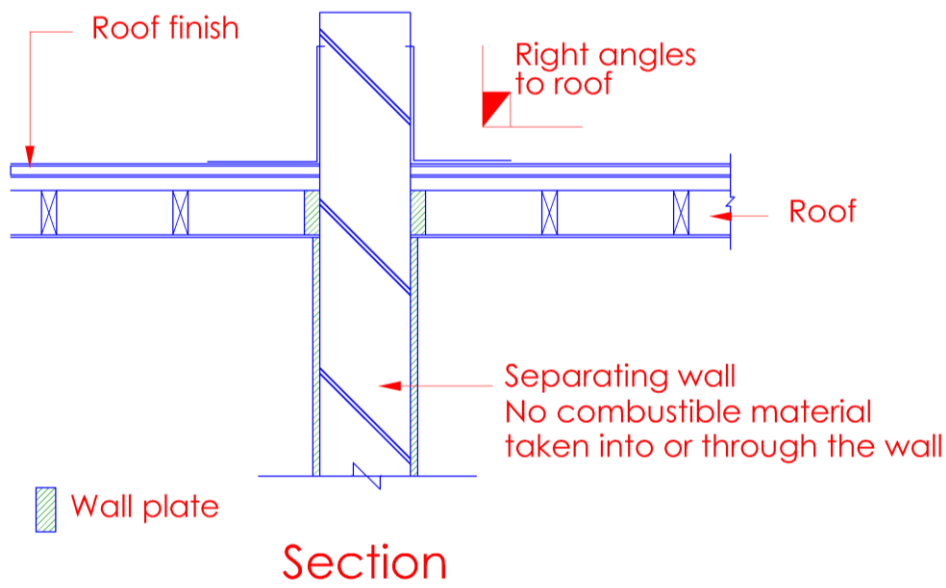

Diagram 3.7.4-1

*Compartment wall is carried right up above the roof coverings to act as a barrier to prevent fire spread over the roof level. The above clause addresses the concern at the junction of compartment walls with roofs and other elements of structure to prevent fire spreading through cracks and gaps at such junctions*

*See subclause 3.6.3 (Separating wall – roof function)*



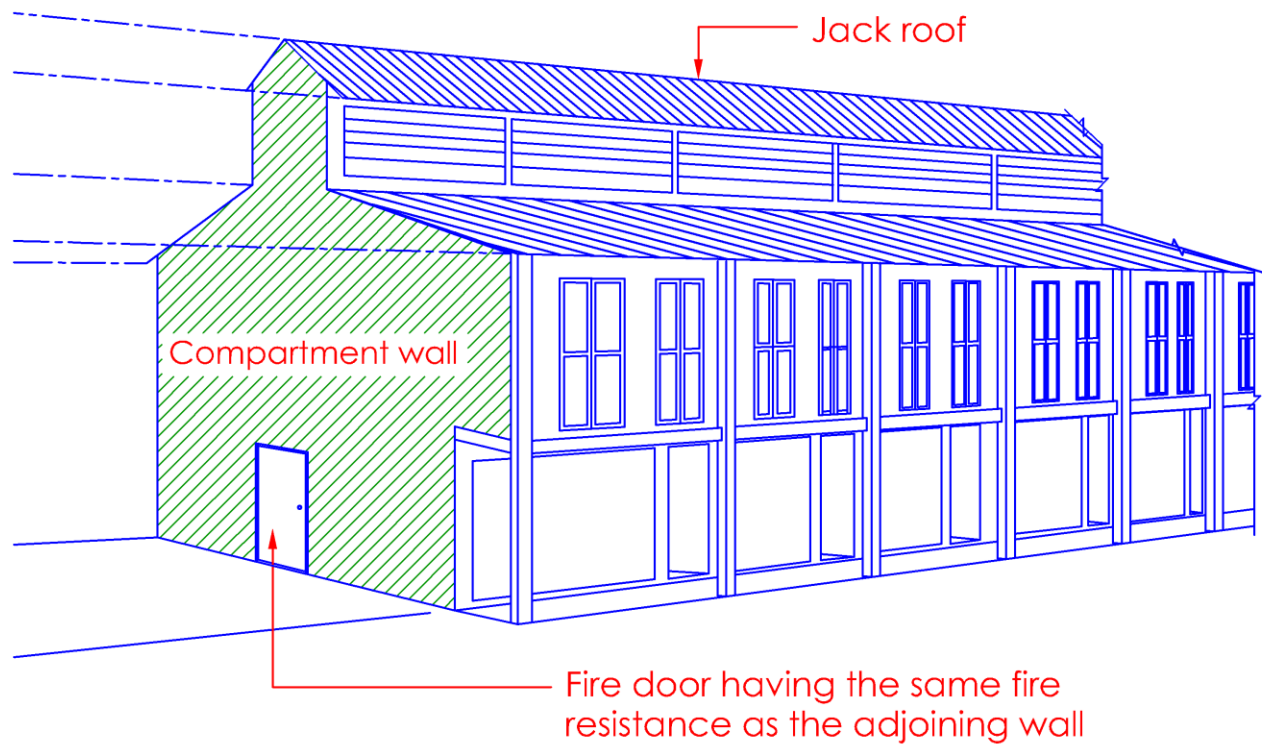

Diagram 3.7.4-2

*Compartment wall shall be brought up to the underside of the roof coverings, including jack roof to complete the fire separation and to prevent fire spread from compartment to compartment. See also sub-clause 3.6.3 (separating wall – roof junction)*

# CHAPTER 3

## 3.7 COMPARTMENT WALLS AND COMPARTMENT FLOORS

<b>3.7.5 Prohibition of combustible materials</b>	
---	--

No combustible material shall be built into, carried through or carried across the ends of any compartment wall or compartment floor or carried over the top of any compartment wall in such a manner as to render ineffective the resistance of such wall or floor to the effects of the spread of fire.	
---	--

<b>EXPLANATIONS &amp; ILLUSTRATIONS</b>	
---	--

<i>See subclause 3.6.5 (Prohibition of combustible material in separating wall)</i>	
---	--

# CHAPTER 3

## 3.7 COMPARTMENT WALLS AND COMPARTMENT FLOORS

### 3.7.6 Non-combustibility of compartment walls or floors

Every compartment wall or compartment floor shall be constructed of non-combustible materials, unless permitted by the Relevant Authority.

#### EXPLANATIONS & ILLUSTRATIONS

*(No illustration)*

*Construction of compartment walls and floors is to be entirely of non-combustible material, except for compartment walls or floors in buildings which are required to be retained by URA under the conservation programme. The exemption was an understanding between FSSB and URA. As a general guide, Qps are required to seek prior consultation with FSSB before making BP submission. There are also certain other exceptions:*

- a) floor finishes*
- b) wall or ceiling linings complying with Cl.3.13*
- c) suspended ceilings under Cl.3.3.6*

*Any structural members carrying compartment walls or floors must also comply with the requirement of non-combustibility. Apart from the contribution made by suspended ceilings under CL.3.3.6, the fire resistance of the structural members must be attained without assistance from any combustible material (with the exception of buildings designated for conservation).*

# CHAPTER 3

## 3.7 COMPARTMENT WALLS AND COMPARTMENT FLOORS

### 3.7.7 Use of fire shutter

Fire shutter is permitted to be used as compartment wall except for fire compartmentation of fire command centre and means of escape which include exit staircase, smoke-stop lobby/fire-fighting lobby, internal exit passageway, etc.

### EXPLANATIONS & ILLUSTRATIONS

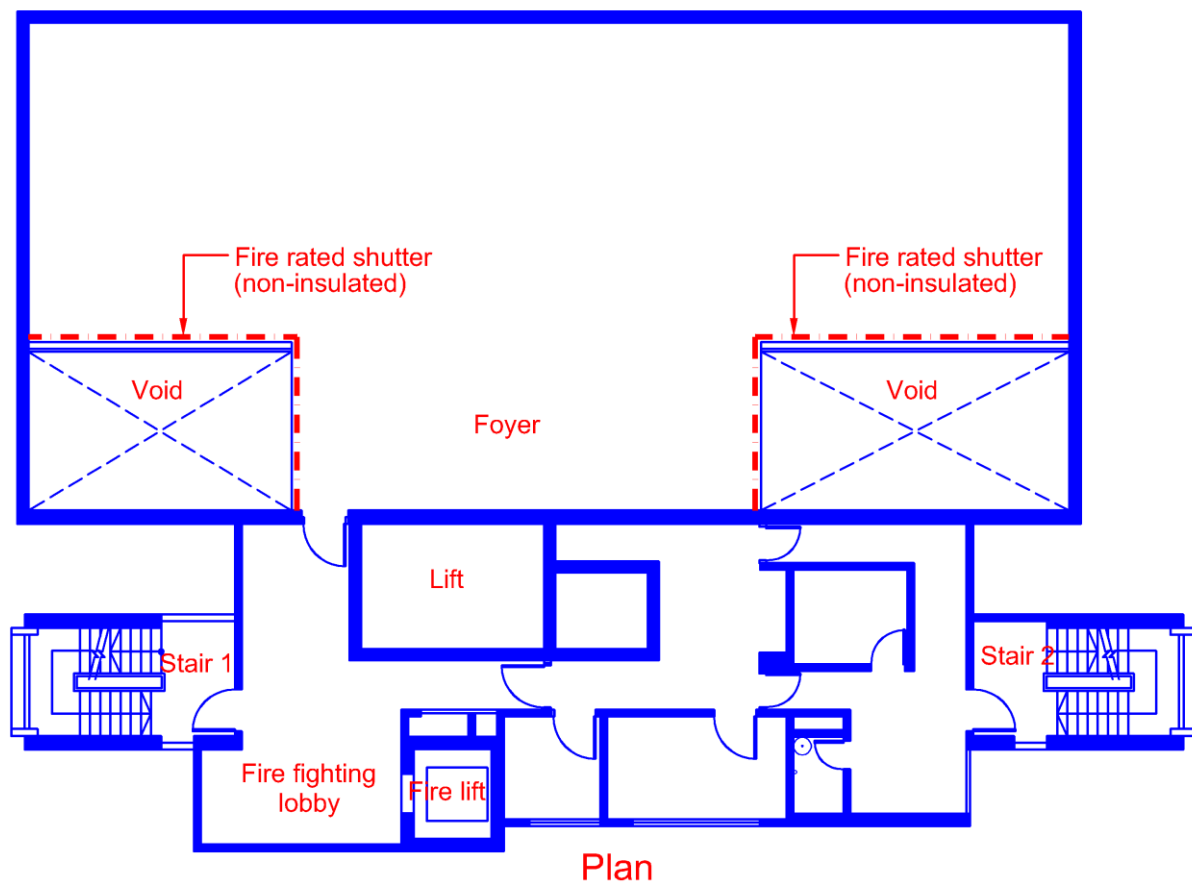

Diagram 3.7.7

*The employment of fire shutter to substitute compartment wall is now permitted provided the fire shutter in-lieu of compartment wall meet stability, integrity and insulation provisions when tested to BS 476: Part 20-23. Do note that placement of combustible items around fire rated shutter is not allowed.*

# CHAPTER 3

## 3.7 COMPARTMENT WALLS AND COMPARTMENT FLOORS

### 3.7.8

The fire shutters, which are used to protect openings in compartment wall/floor, shall have the necessary fire resistance including thermal insulation, not less than that of the compartment wall/floor. However, fire shutters, which are installed at the edge of atria, voids such as escalator void areas and between floors and door way, need not have thermal insulation.

### EXPLANATIONS & ILLUSTRATIONS

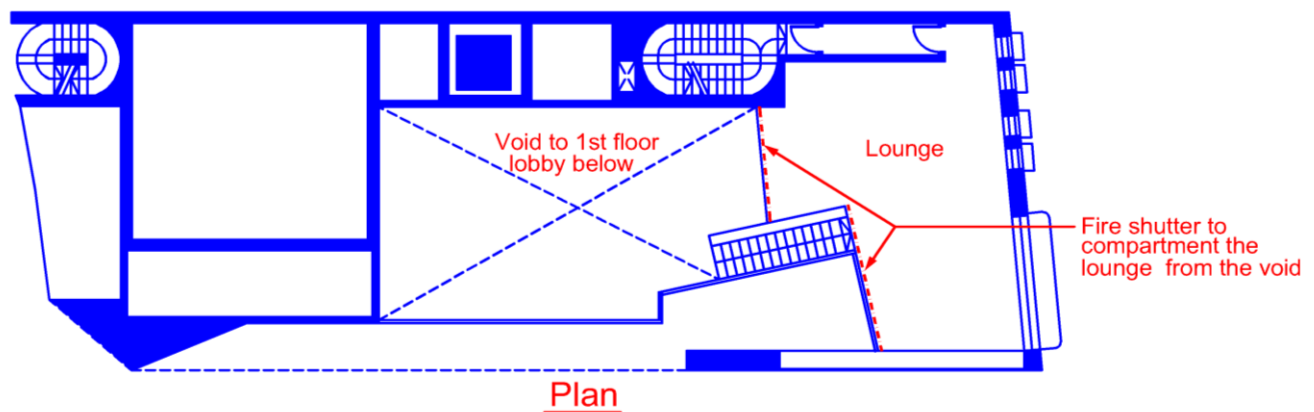

Diagram 3.7.8

*The fire shutters, which are installed at the edge of atrium, void facing escalator and at door way are intended as relaxation. The reason for not requiring insulated fire shutter at door way is because the opening width is basically not overly big. The conventional fire door need not be tested to conform to insulation criterion. Hence, vertical fire shutter to substitute fire door will not be required to subject to insulation provision. All habitable spaces enclosed by the fire rated shutter are to be provided with exit for the occupants to escape either via a side door or a wicket door.*

# CHAPTER 3

## 3.7 COMPARTMENT WALLS AND COMPARTMENT FLOORS

### 3.7.9

The commonly used shutters such as vertical, horizontal and lateral fire shutters shall comply with SS 489 and the following:

(a) For vertical fire shutter operated by gravity during fire condition:

Upon activation by fire alarm system or fusible link, the operating mechanism of curtains/leaves of vertical fire shutter shall be released. The curtain/leaves shall descend under gravity at a controlled rate.

(b) For electrically operated vertical, lateral and horizontal fire shutter (no fusible link is required):

Upon activation by fire alarm system, the electrical motor shall drive the curtains/leaves to descend and shall be backed up by emergency power supply. The power and signal cables shall be fire-rated.

### EXPLANATIONS & ILLUSTRATIONS

*(No illustration)*

# CHAPTER 3

## 3.7 COMPARTMENT WALLS AND COMPARTMENT FLOORS

### 3.7.10

The mode of activation for fire shutters at different locations shall be as follow:

(a) Fire shutters as separating wall between two buildings:

(i) Two buildings separated by a common fire shutter:

For vertical fire shutter operated by gravity and electrically operated fire shutters, it shall be linked to fire alarm systems of both buildings and shall be activated by fire alarm system of either building. Mode of activation by fusible link only is not permitted.

(ii) Two buildings separated by two separate fire shutters:

For vertical fire shutter operated by gravity and electrically operated fire shutters, each fire shutter shall be activated by the fire alarm system of its own building. Mode of activation by fusible link only is not permitted.

(b) Fire shutters as compartment wall/floor for limiting compartment area and cubical extent, as compartment between different purpose groups, as compartment of special rooms such as kitchen, electrical room, store room, etc. and as compartment of basement passenger/goods lift lobby:

(i) For vertical fire shutter operated by gravity, mode of activation by fusible link is acceptable.

(ii) For electrically operated fire shutter, mode of activation shall be by local smoke detectors.

(c) Fire shutters as compartmentation at atrium/voids or between floors (being part of the engineered smoke control design):

(i) Only electrically operated fire shutter is permitted. Signal to operate the respective fire shutter shall be from dedicated smoke detector installed at the respective smoke zone.

(ii) Vertical fire shutter operated by gravity activated by fusible link is not permitted.

### EXPLANATIONS & ILLUSTRATIONS

*No illustration.*

# CHAPTER 3

## 3.8 PROTECTED SHAFTS

### 3.8.1 Purpose of protected shaft

A protected shaft shall not be used for any purpose additional to those given as defined under Cl.1.2.47.

All services such as, pipe/duct installation should not be located inside protected staircase. Likewise, no washroom is allowed to be located inside protected staircase.

### EXPLANATIONS & ILLUSTRATIONS

*No illustration.*

*The purposes of providing protected shaft are to delay or prevent the spread of fire between compartments through which staircases or other shafts pass directly and to enable people or things or air to pass between compartments. The purpose of each shaft are as follows :*

- i) The staircase shaft is a vertical shaft which enables the passage of movements of people.*
- ii) The service shaft enables the passage of cable, building service ducts/pipes.*
- iii) The lift shaft enables the movements of lift cars.*

*“Protected Shafts” include staircase, lift shafts, chutes, ducts or any other shaft enabling movement of people, goods, air, pipes, etc.*

*Protecting structures shall be treated as elements of structure for the purpose of determining the period of fire resistance rating.*

*Construction of compartment walls and floors shall be constructed entirely of non-combustible material. However, there were exceptions specially allowed for under the conservation programme. The exemption was an understanding between SCDF (FSSD) and URA. As a general guide, QPs are required to seek prior consultation with SCDF (FSSD) before making formal building plan submission.*

*Any structural members carrying compartment walls or floors must also comply with the requirement of non-combustibility. Apart from the contribution made by suspended ceilings under CL.3.3.6, the fire resistance of the structural members must be attained without assistance from any combustible material (with the exception of buildings designated for conservation).*



# CHAPTER 3

## 3.8 PROTECTED SHAFTS

### 3.8.2 Requirements of protected shaft

Every protected shaft shall be required to –

- (a) Form a complete barrier to fire between the different compartments which the shaft connects, and
- (b) Have the appropriate fire resistance to comply with the requirements of Cl.3.3, and
- (c) Be constructed of non-combustible material (together with any beam or column which forms part of the enclosure and any structure which carries it).

### EXPLANATIONS & ILLUSTRATIONS

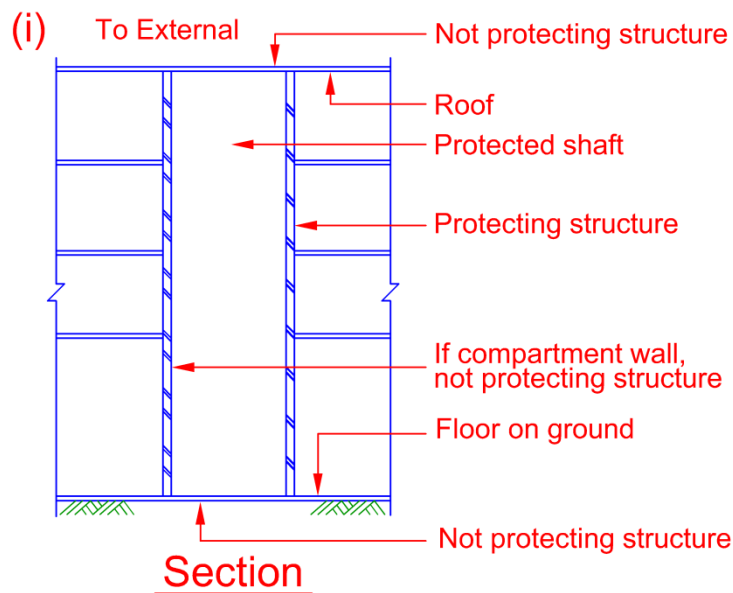

Diagram 3.8.2-1

*Protected shafts penetrate across compartments or floors in a building. They can be shafts carrying utilities (piping, electrical and telecommunication cables etc) or service shafts carrying lifts and exit staircases. The enclosing walls and floors to the protected shaft shall be constructed of non-combustible materials, including any beam or column, which forms part of the enclosure.*

*In the above diagram, a protected shaft is enclosed at the top by roof slab, the sides by fire rated walls and the bottom by the ground floor slab. The protecting structures to the shaft would exclude the roof slab, which is exposed to the external, the ground floor slab, which is in contact with the ground and any compartment wall, which separates one compartment from another.*

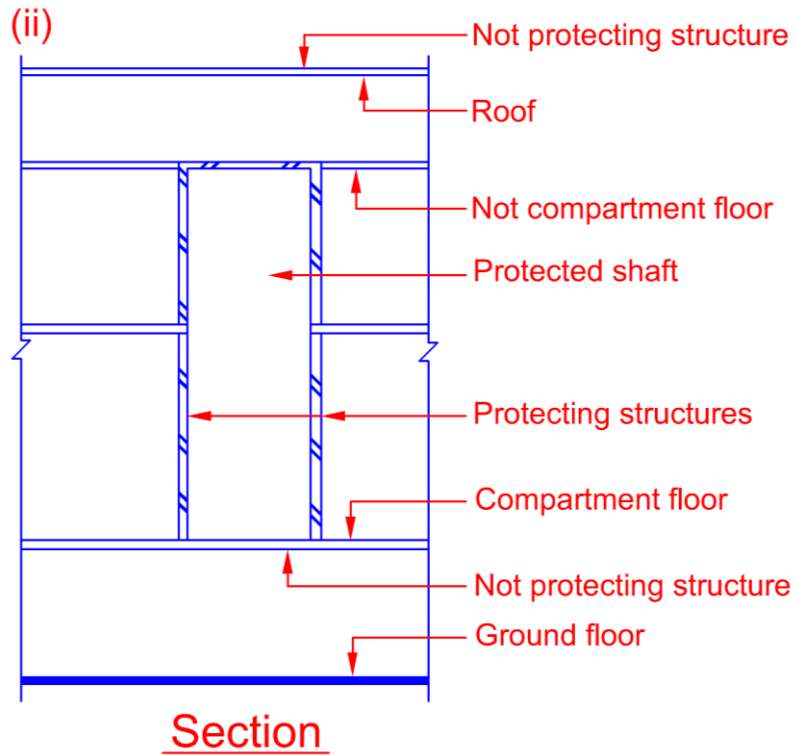

Diagram 3.8.2-2

*Protected shaft is enclosed by internal walls, ceiling and floor. Protecting structures will include the walls and slab above; and the floor at the base of shaft is excluded, because it is a compartment floor.*

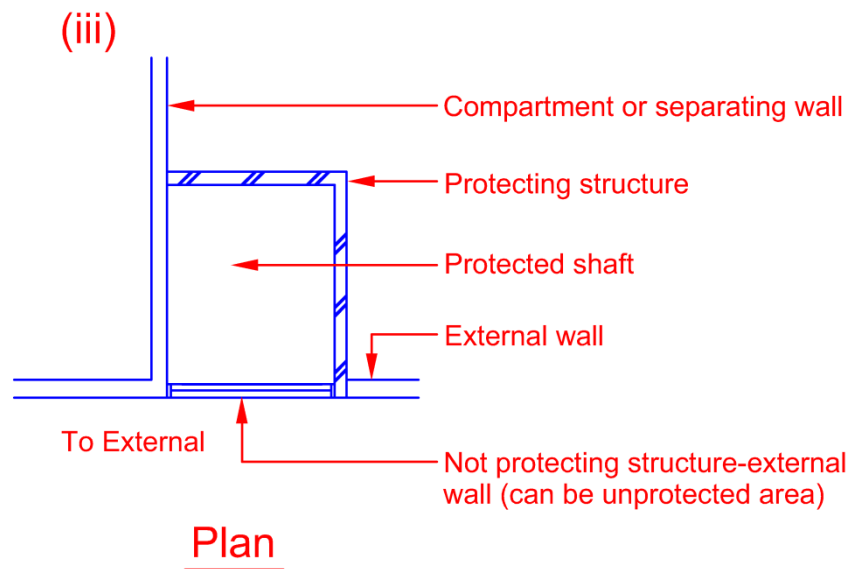

Diagram 3.8.2-3

Protected shaft is located against an external wall. The protecting structures will include internal walls, which are not compartment or separating wall.

See Cl.1.2.48 under Definition

Where the protection afforded to a compartment is penetrated to allow the movement of people, goods or anything else between compartments by means of eg. a staircase, lift or duct, the protection to the compartment must not be lowered or diminished. This is achieved by enclosing the means of transportation from one compartment to another in a protected shaft which is so constructed that any penetration of the enclosures to the shaft poses no direct or indirect threat to the compartments connected by the shaft. Hence, the term “protected shaft” and “protecting structure” for the structure enclosing such a shaft. The elements enclosing the shaft (unless formed by adjacent external walls) are compartment walls and floors.

Diagram 3.8.2 - 3 of the above diagram illustrates a shaft, which is enclosed by compartment or separating wall, external wall and internal walls called protecting structure. The fire resistance of the compartment or separating wall should be based on the size of the floor area or cubical extent of the adjoining larger compartment and shall not be less than 1-hour.

The fire resistance of the external wall would be determined by the separation distance requirements under Cl.3.5. The external wall is not a protecting structure and could be fully unprotected areas having no fire resistance. The remaining 2 walls of the shaft are protecting structure which must be imperforate except for certain permitted openings, e.g. inspection doors which need to have fire resistance equivalent to half that of the protecting structure. All protecting structure shall be constructed of non-combustible material except for surface linings, which shall comply with Cl.3.13. The fire resistance of the protecting structures shall be that for the elements of structure of the building.

Protecting structures exclude external wall. External walls need not have fire resistance rating, subject to complying with Cl.3.5 to be unprotected areas.

# CHAPTER 3

## 3.8 PROTECTED SHAFTS

### 3.8.3 Openings in protected shaft

A protected shaft shall have no openings in its enclosure, except -

- (a) In the case of any part of the enclosure which is formed by a separating wall, any opening which complies with the requirements of Cl.3.6 for separating walls, or
- (b) In the case of any part of the enclosure which is formed by a compartment wall or a compartment floor, any opening which complies with the requirements of Cl.3.7 for compartment wall or compartment floor, or
- (c) In the case of any part of the enclosure which is formed by the protecting structure –
  - (i) a door which has the appropriate fire resistance to comply with the requirements of Cl.3.4 for test of fire resistance, or otherwise permitted by provision of Cl.3.8.6, or
  - (ii) the passage of a pipe, excluding protecting structure to exit staircase and exit passageway, or
  - (iii) inlets to and outlets from and opening for the duct, if the shaft contains or serves as a ventilation duct,

such openings in the protected shaft shall be protected to comply with the relevant provisions of Cl.3.9 for protection of openings.

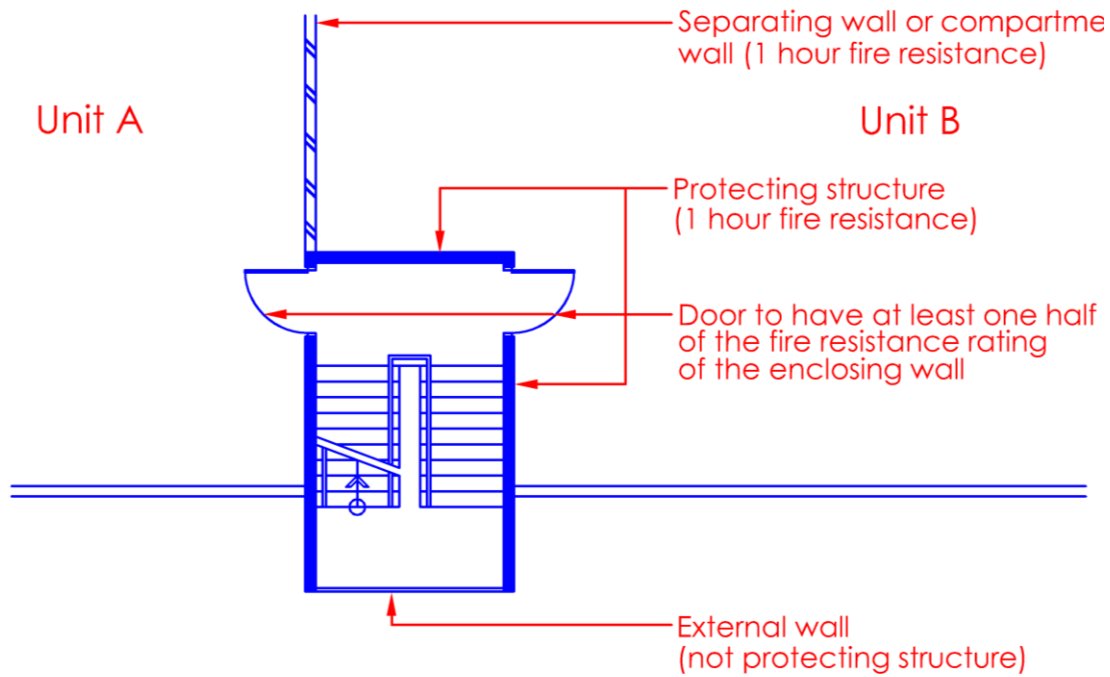

Diagram 3.8.3(a)

*Protected shaft bounded on three sides by protecting structure and fourth side by an external wall. Permitted opening to each unit shall be protected by a door of at least one half of the fire resistance rating of the enclosing wall, or half an hour, whichever is the greater. The aggregate fire resistance of the 2 doors shall not be less than the fire resistance of the protecting structure.*

*Permitted openings in protected shaft*

a) Shaft containing ventilation duct pipes

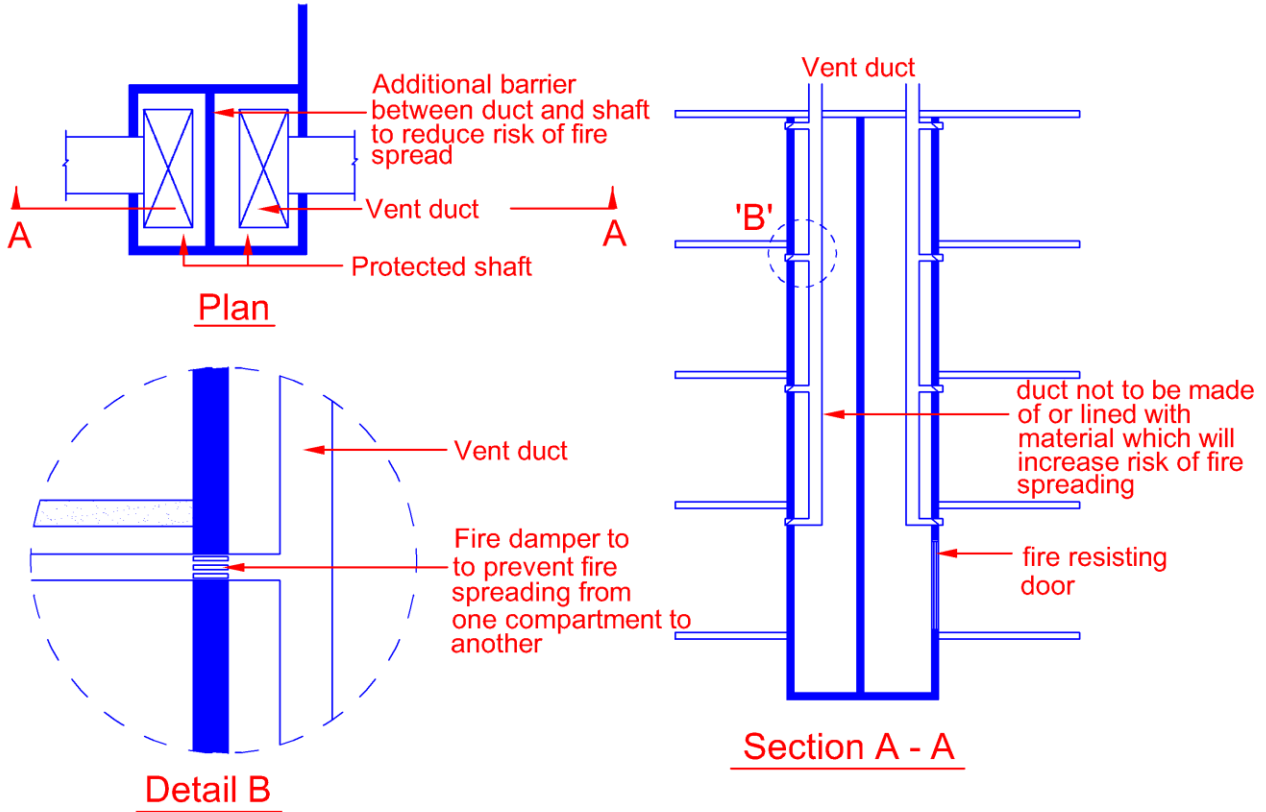

Diagram 3.8.3(c)-1

b) Shaft containing gas pipe

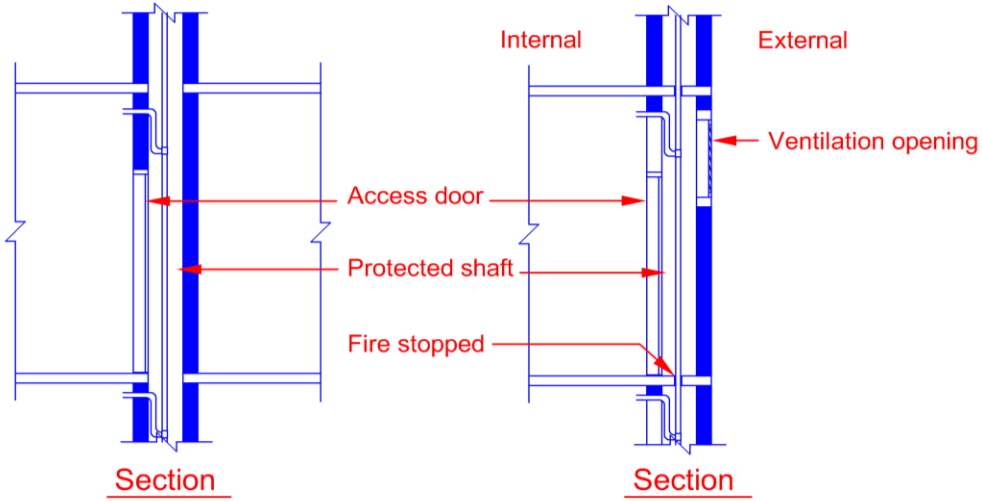
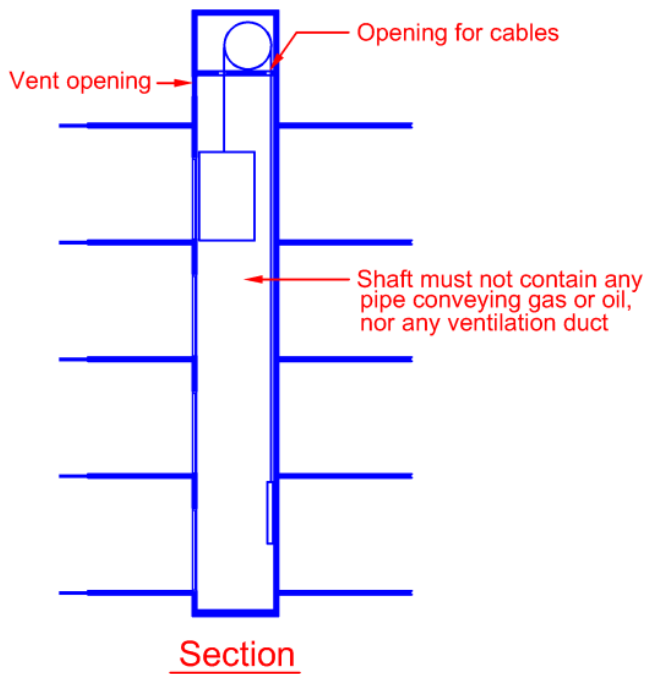

Diagram 3.8.3(c)-2

c) Shaft containing a lift



d) Shaft containing exit staircase

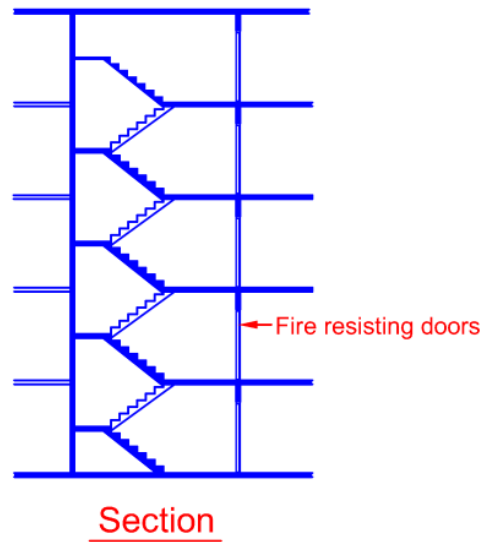

Diagram 3.8.3(c)-3

*Fire resisting doors to comply with Cl.3.9.2 and shall have ½ hour fire resistance or half the resistance of the enclosing walls, whichever is the greater*

- 1) *Any opening in compartment floor/wall would constitute a break in compartmentation. Therefore even small service pipes, strictly speaking must be enclosed in protected shaft.*
- 2) *However, clause 3.9 allows pipe size not greater than those sizes provided in Table 3.9A to be unprotected, provided the pipes are to be spaced at min. 50mm apart or half the diameter of the larger pipe, whichever is larger. This is to avoid clustering of pipes which would weaken the compartment floor or wall*
- 3) *Openings in compartment floors to accommodate staircases, lifts and services form a vertical shaft which can become a ready means of passage of fire from one storey to another, accentuated by the flue effect created by a fire.*
- 4) *Hence, protected shafts are needed to maintain the overall fire integrity of the building. However, these shafts need to have door openings for movement of people, eg. staircase, lifts and maintenance purposes in the case of shafts containing services. All the door openings to protected shaft are considered the sources of weakness in the integrity of the shafts and they must be protected.*

#### Door openings

- 5) *Doors in protected shaft must have at least ½ hour fire resistance rating or half the fire resistance of the protecting structure whichever is greater.*
- 6) *Such a relaxation from the full standard of fire integrity is reasonable as it is expected that combustible materials would not be placed next to the door and that a fire has to break into the shaft and break out again at the upper level. Also if the top of the shaft is adequately ventilated, the tendency for lateral spread is considerably reduced.*
- 7) *The primary purpose of protecting structure is to provide the compartmentation between floors. As such the structure shall have full fire resistance as the elements of structure. The relaxation on fire resistance accorded to fire doors shall not be extended to the protecting structure ie. halve the fire resistance of the elements of structure. The main reason is that by halving the fire resistance of protecting structure, the threat of failure and collapse of the enclosing walls would be greater in times of fire emergency and should the walls collapse, large opening would be created in the shaft to permit the spread of fire and smoke, which is not acceptable. As to door openings in protected shaft, the eventual failure of the fire door is considered acceptable owing to the limited door opening size. See illustrations (c) and (d).*
- 8) Ventilation ducts  
*Ventilation ducts are usually constructed of sheet metal, which do not have fire resistance and therefore should a fire occur, they will quickly distort and collapse leaving a hole in any wall through which they pass. Conversely, a fire occurring in the duct could also cause collapse.*



- 9) *Therefore, where the duct penetrates the protected shaft, a fire damper should be fitted at the opening of the protecting structure. The fire damper shall be capable of sealing the opening in the protecting structure and be installed independently of the duct trunking. In this way, the fire damper would not be affected by collapse of duct work and be able to maintain the fire integrity of the shaft. See illustration (a).*
- 10) Pipes  
*Where pipes are contained within a protected shaft, the problem of maintaining the integrity of the fire compartment is made simple, irrespective whether the pipes are made of UPVC or combustible materials. However, for gas pipes or pipes containing combustible liquids, they shall be located in separate shafts.*
- 11) *The construction of gas pipes shaft is different from other shafts owing to the need to provide through or external ventilation. Gas pipe shaft shall comply fully with SS CP 51. See illustration (b).*
- 12) General  
*In order to maintain the level of integrity of protected shafts, openings in protected shafts shall be restricted to the following :*
- a) Openings for pipe*
  - b) Door openings to lift shaft, staircase*
  - c) Openings for ventilation ducts*
  - d) Access openings for electrical cables shaft*
  - e) Openings for chutes, linen or refuse.*

# CHAPTER 3

## 3.8 PROTECTED SHAFTS

### 3.8.4 Non-combustibility of protecting structures

Every protecting structure shall be constructed wholly of non-combustible materials except that floor, wall and ceiling finishes which do not contribute to the fire resistance of such protecting structure may not be required to comply with the requirements for non-combustibility.

### EXPLANATIONS & ILLUSTRATIONS

*(No illustration)*

*The requirement that all protecting structure shall be constructed of non-combustible materials is also spelled out under Cl.3.8.2. As to the provision of combustible finishes to floor, wall and ceiling, it must be observed that such provision will not be permitted inside protected shafts that are used for the passage of people such as exit staircases, exit passageways and smoke-stop lobbies under Cl.3.10.4 and Cl.3.13.6.*

# CHAPTER 3

## 3.8 PROTECTED SHAFTS

### 3.8.5 Ventilation of protected shaft

Ventilation of protected shaft shall comply with the following:

- (a) A protected shaft used for the passage of people, such as exit staircases, shall be ventilated to comply with the relevant provisions of the Code.
- (b) A protected shaft containing a pipe conveying gas shall be adequately ventilated directly to the outside air or have other modes of ventilation allowed under SS CP 51.

### EXPLANATIONS & ILLUSTRATIONS

*No illustration.*

*Protected shaft used for passage of people, such as exit staircases shall be provided with adequate natural ventilation by fixed openings in the external walls. Such openings shall have an area of not less than 10 per cent of the floor area per floor of the staircase. Alternatively, the staircase can be mechanically ventilated under Cl.2.3.3(f). However, for internal exit staircase serving more than 4 storeys, the supply air shall be mechanically conveyed via a vertical duct extending through the staircase height and discharging from outlets distributed at alternate floor. Where the internal exit staircase exceeds 24m in height without provision for natural ventilation, the staircase shall be pressurised in accordance with Cl.2.3.3(g).*

*The mechanical ventilation system to internal staircase serving more than 4 storey and the pressurization system to internal exit staircase exceeding 24m shall be connected to emergency power supply. In addition, a remote manual start-stop switch shall be make available to fire fighters at the fire command centre, or at the fire indicating board where there is no fire command centre. The start-stop switch provides the fire fighter a quick means to shut-off the fans should it be detected that smoke had been drawn into the staircase by the fresh air supply fan.*

*A protected shaft conveying piped flammable gas should be adequately ventilated directly to the outside air by ventilation openings at high and low level in the shaft or comply with the modes of ventilation allowed in CP51. All gas pipe installations shall be vetted and approved by acceptable organisation (example: Powergas) before any works can be carried out on site.*

# CHAPTER 3

## 3.8 PROTECTED SHAFTS

### 3.8.6 Doors in protecting structures

Any door fitted to an opening in protecting structure shall have fire resistance for not less than half the period required by other provisions of the Code for the protecting structure surrounding the opening.

Exception :

Any door fitted to an opening in protecting structure of a shaft containing services such as electrical cables, pipes (including gas pipe in separate shaft), ducts would not need to have the fire resistance rating if the door is located along the wall facing the external corridor.

### EXPLANATIONS & ILLUSTRATIONS

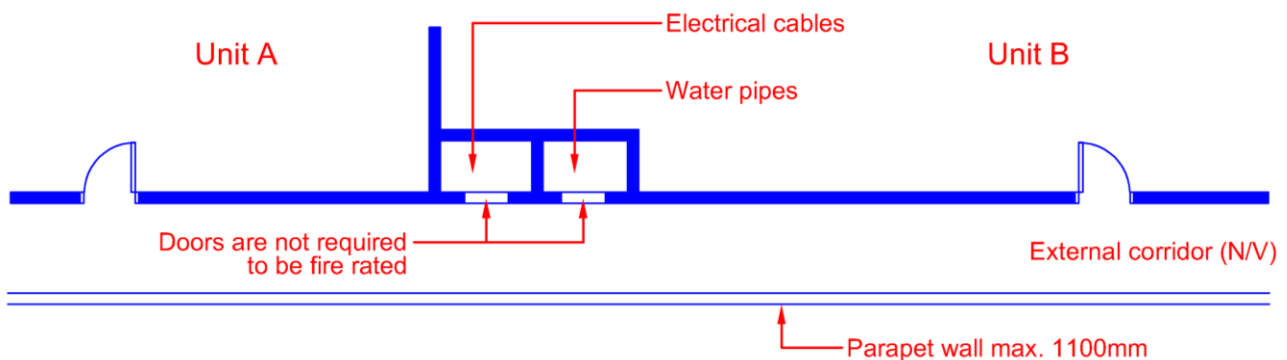

Diagram 3.8.6-1

As the doors in the electrical and pipe shafts are opening into an external corridor which is naturally ventilated, there is no need to fire rate the doors.

Protected shaft A serves 2 compartments. Compartment A could be a common area eg. lounge and compartment B in factory/warehouse unit.

Door A1 is opening in the direction of exit travel, whereas door A2 is the entrance door of the factory/warehouse unit, which swings inward. The number of exit door openings in a protected shaft containing an exit staircase shall not exceed two per floor. This is to prevent additional openings from weakening the integrity of the protecting structure.

The aggregate fire resistance of door A1 and A2 shall not be less than the compartment wall or the protecting structures to the shaft. This is to ensure that the fire resistance between compartment A and B is not reduced at the door openings.

Door A1 can be held in the open position provided it is fitted with electro-magnetic or electro-mechanical device. See Cl.1.2.20 in Volume I.

All doors in shaft A & B shall have the fire resistance rating of half that of the enclosing protecting structures to the shafts, but shall never be less than half hour. See also Cl. 3.8.3 for further explanation.

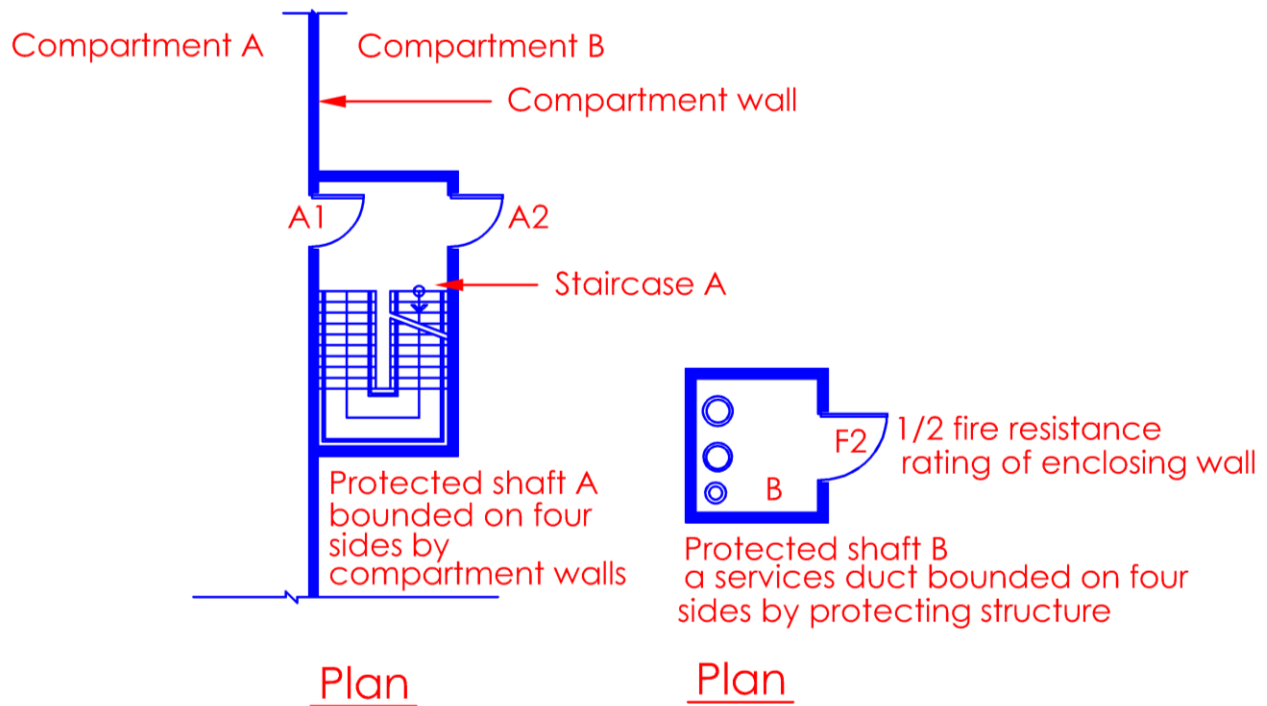

Diagram 3.8.6-1

*Protected shaft A serves 2 compartments. Compartment A could be a common area eg. lounge and compartment B in an office unit.*

*All doors in shaft A & B shall have the fire resistance rating of half that of the enclosing protecting structures to the shafts, but shall never be less than half hour. See also Cl. 3.8.3 for further explanation.*

*Door A1 is opening in the direction of exit travel, whereas door A2 is the entrance door of the health care occupancy unit, which swings inward. The number of exit door openings in a protected shaft containing an exit staircase shall not exceed two per floor. This is to prevent additional openings from weakening the integrity of the protecting structure.*

*The aggregate fire resistance of door A1 and A2 shall not be less than that of the compartment wall or the protecting structures to the shaft. This is to ensure that the fire resistance between compartment A and B is not reduced at the door openings.*

*Door A1 can be held in the open position provided it is fitted with electro-magnetic or electro-mechanical device. See Cl.1.2.20.*

# CHAPTER 3

## 3.8 PROTECTED SHAFTS

### 3.8.7 Protected shaft containing exit staircase

- (a) A protected shaft which contains an exit staircase shall not contain any services e.g. pipes, cables, ducts, etc., that are not solely serving the exit staircase (even if the services are protected with fire rated dry construction), except for:
  - (i) cut-off sprinkler and pipe for that staircase; and
  - (ii) UPVC or cast iron rain water downpipes serving the roof directly above the exit staircase, and not routed through anywhere outside the staircase.
  - (iii) rising mains.
- (b) The protecting structure shall be constructed of masonry, or drywall. If drywall construction is used, the following conditions shall be complied with :
  - (i) Drywall shall be non-combustible; and
  - (ii) Drywall shall have fire resistance for not less than the relevant period specified in Table 3.3A having regard to the purpose group of the building of which it forms a part and the dimension specified in that Table; and
  - (iii) Drywall shall meet the criteria, in terms of impact and deflection performance, when subject to the tests of BS 5588 Pt 5 Appendix A and BS 5234 Pt 2; and
  - (iv) Drywall shall meet the criteria, in terms of water absorption and bending strength performance, when subject to the test of BS EN 520 (for gypsum plaster board) or ISO 1896 (for calcium silicate or cement board); and
  - (v) The building shall have at least two independent exit staircase shafts (scissors staircases are considered as single shaft).

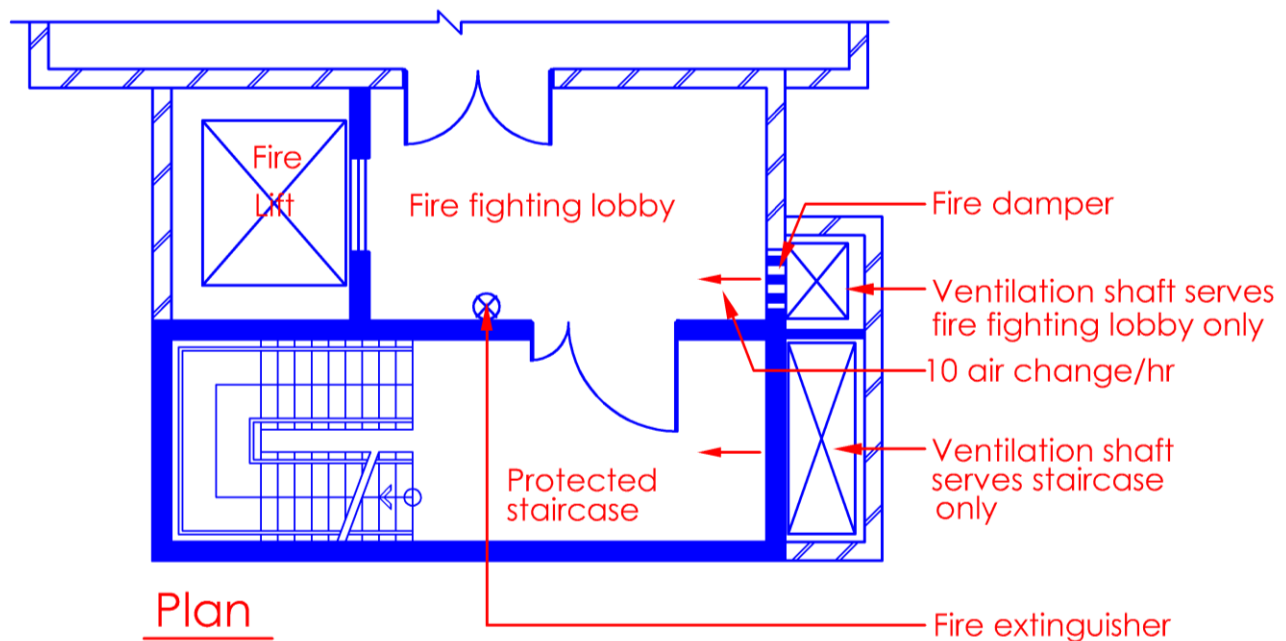

Diagram 3.8.7(a)

An exit staircase designated as fire fighting staircase in a building, which exceeds 24m in habitable height has to be complemented by fire lift and fire fighting lobby. Separate ventilation shafts are required to be provided for the staircase and fire fighting lobby as depicted in Clause 7.1.4.

Exit staircases serving any building irrespective of the height, shall be devoid of combustible wall, floor and ceiling finishes. Building services which are not solely serving the exit staircase shall not be allowed to be routed through or inside the staircase. This is to prevent any possibilities of a fire occurring inside the staircase and the spread of fire into the staircase via the services such as electrical cables, ducts, combustible pipes, etc. Clause 6.2.2 of the Fire Code allows vertical stack of rising main and landing valve to be located inside the staircase as a last resort where smoke-stop lobby and common area outside the staircase are not available. Clause 2.4.3 of SS CP 10 allows sub-alarm panels to be located in the exit staircase provided there is no fire lift lobby or smoke-stop lobby in the building. The fire alarm cables shall be in metal conduit or trunking. This relaxation shall not apply to buildings which are more than 4 storeys in height where provision of smoke-stop lobby is a requirement.

The exit staircases are the means of escape in fire emergencies. All occupants must use the staircases to evacuate safely from any storey level to the final exits at ground level. The time taken to descend a staircase in a high-rise buildings could be more than an hour. With the staircase fully packed with evacuating occupants during an emergency, the staircase must be maintained safe from smoke, heat and fire throughout the fire resistance period of the enclosing protecting structures to the staircase. An exception is allowed under Cl.3.8.9(d) for maximum 4 storey residential building.

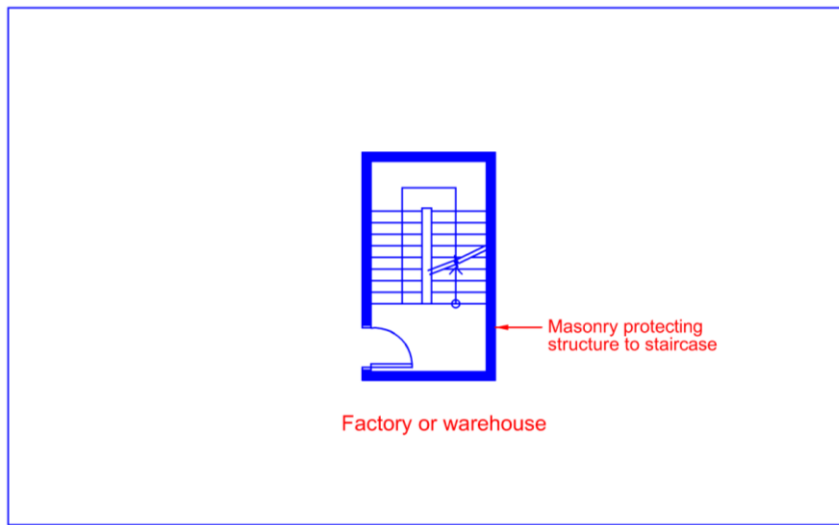

Diagram 3.8.7(b)-1

*Building designed with single exit staircase shall have the protecting structure constructed of masonry, which is more solid and stable than fire rated dry walls. The main concern is that if the protecting structure, which is constructed of dry wall is damaged, smoke and heat would get into the staircase to affect the evacuees making their way down. Single exit staircase shall have its protected structure constructed of masonry.*



Diagram 3.8.7(b)-2

*Where two independent staircases are provided, the protecting structure to each of the staircase can be constructed of drywall.*



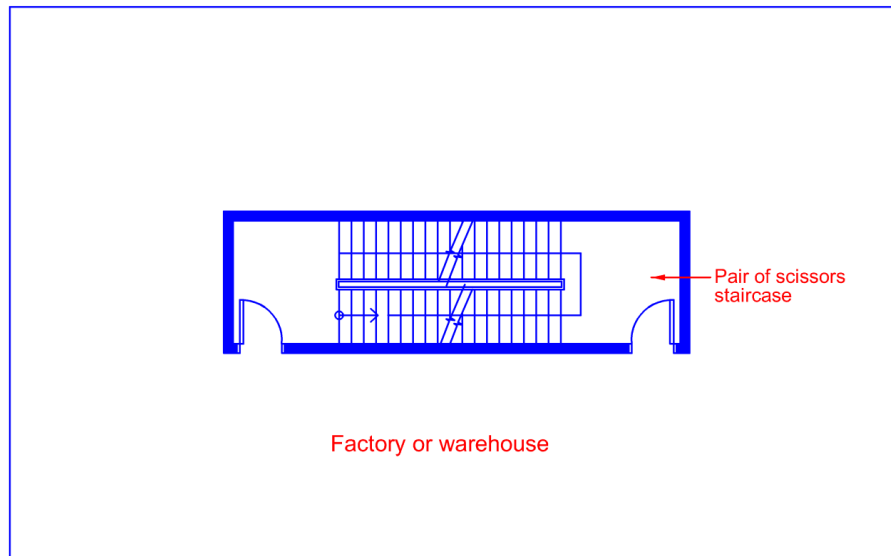

Diagram 3.8.7(b)-3

Where a building is designed with a pair of scissors staircases to meet the provision of exit requirements, the scissors staircases shall be considered as within a common shaft if drywall is used for the construction of the protecting structure. The main reason is that if one of the shaft is damaged, the other shaft is likely to be affected, thereby causing smoke to get into both staircases. This would render the pair of scissors staircases inaccessible. In addition, the drywall enclosures are prone to other damages, thus affecting the effectiveness and integrity of the protected shafts. However, for the purpose of exit computation, the pair of scissors staircases shall literally be taken as 2 staircases though it could only qualify as a single shaft.

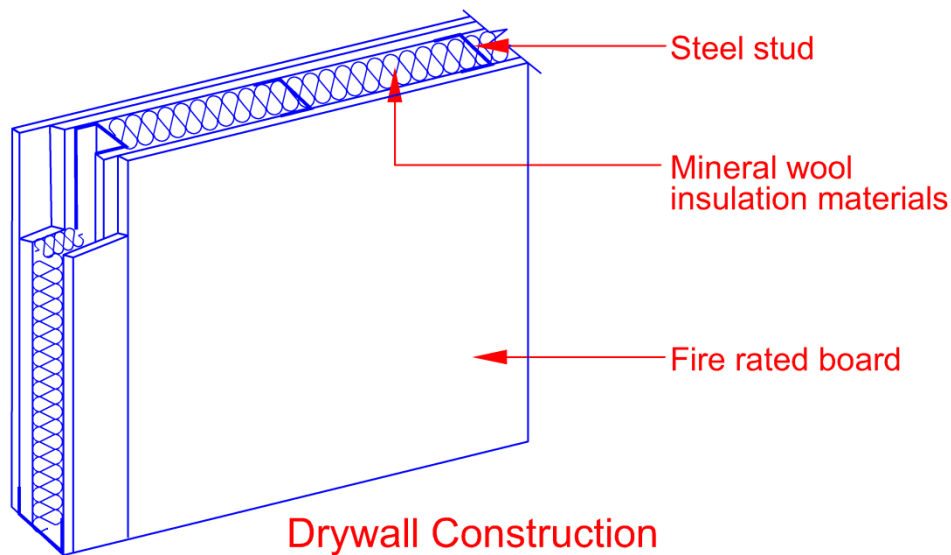

Diagram 3.8.7(b)-4

Non-combustible steel studs, insulation materials and fire-rated boards shall be used for the construction of drywall

# CHAPTER 3

## 3.8 PROTECTED SHAFTS

### 3.8.8 Lift shaft

A protected shaft which contains a lift shall comply with the following:

- (a) It shall not contain any pipe conveying gas or combustible liquid, other than those in the mechanism of a hydraulic lift.
- (b) The protecting structure shall be constructed of masonry, or drywall. If drywall construction is used, the following conditions shall be complied with :
  - (i) Drywall shall be non-combustible; and
  - (ii) Drywall shall have fire resistance for not less than the relevant period specified in Table 3.3A having regard to the purpose group of the building of which it forms a part and the dimension specified in that Table; and
  - (iii) Drywall shall meet the criteria, in terms of impact and deflection performance, when subject to the tests of BS 5588 Pt 5 Appendix A and BS 5234 Pt 2; and
  - (iv) Drywall shall meet the criteria, in terms of water absorption and bending strength performance, when subject to the test of BS EN 520 (for gypsum plaster board) or ISO 1896 (for calcium silicate or cement board); and
  - (v) Drywall shall meet the criteria of Cyclic Loading and Dynamic test as specified under C1.3.3 of Building Code of Australia Specification C 1.8.

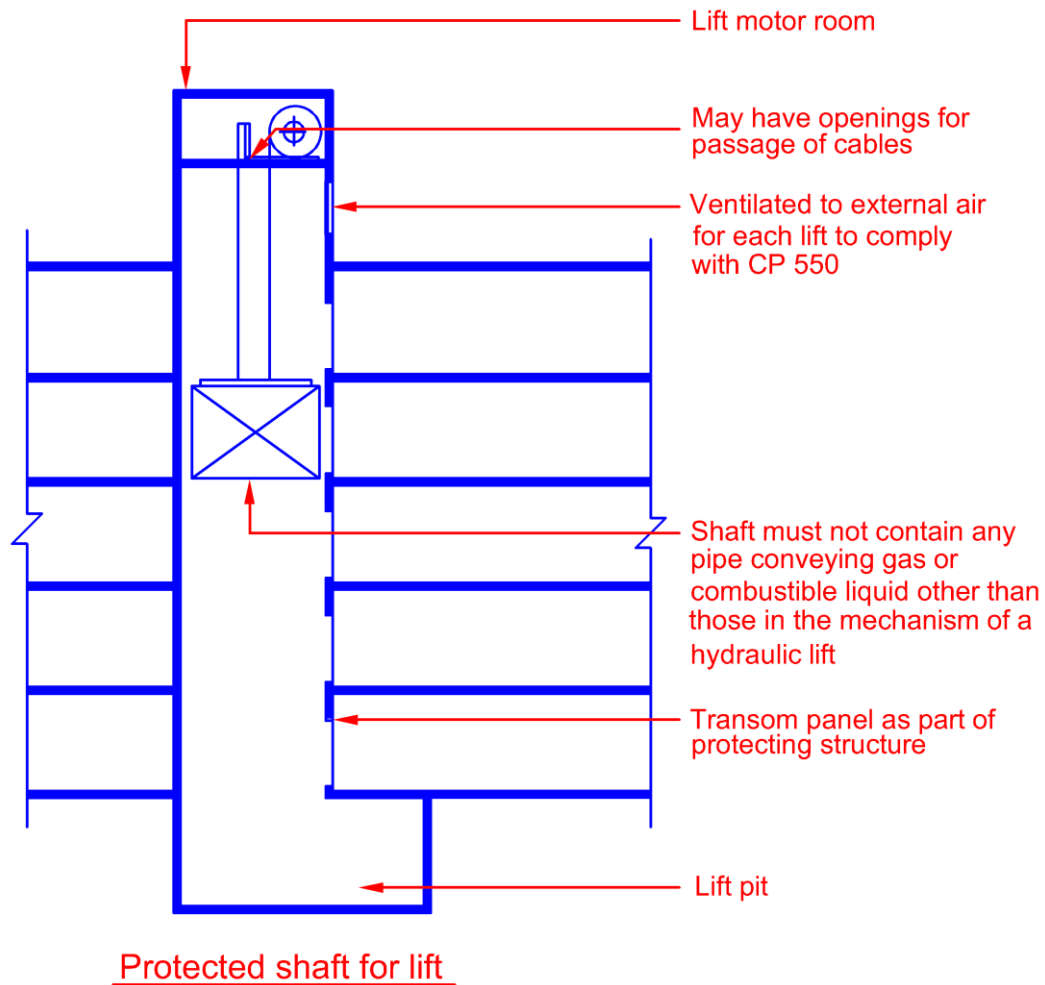

Diagram 3.8.8(a) & (b)-1

Lift shaft which is not located at the edge of atrium floors or at the external wall outside the building shall be constructed of masonry.

Sub-clause (a) above specifically permits combustible liquid in the mechanism of hydraulic lift. The liquid is concealed in vessels and forms part of the mechanical system to permit the homing of the lift during an emergency. The liquid has a high flash point of over 400°C.

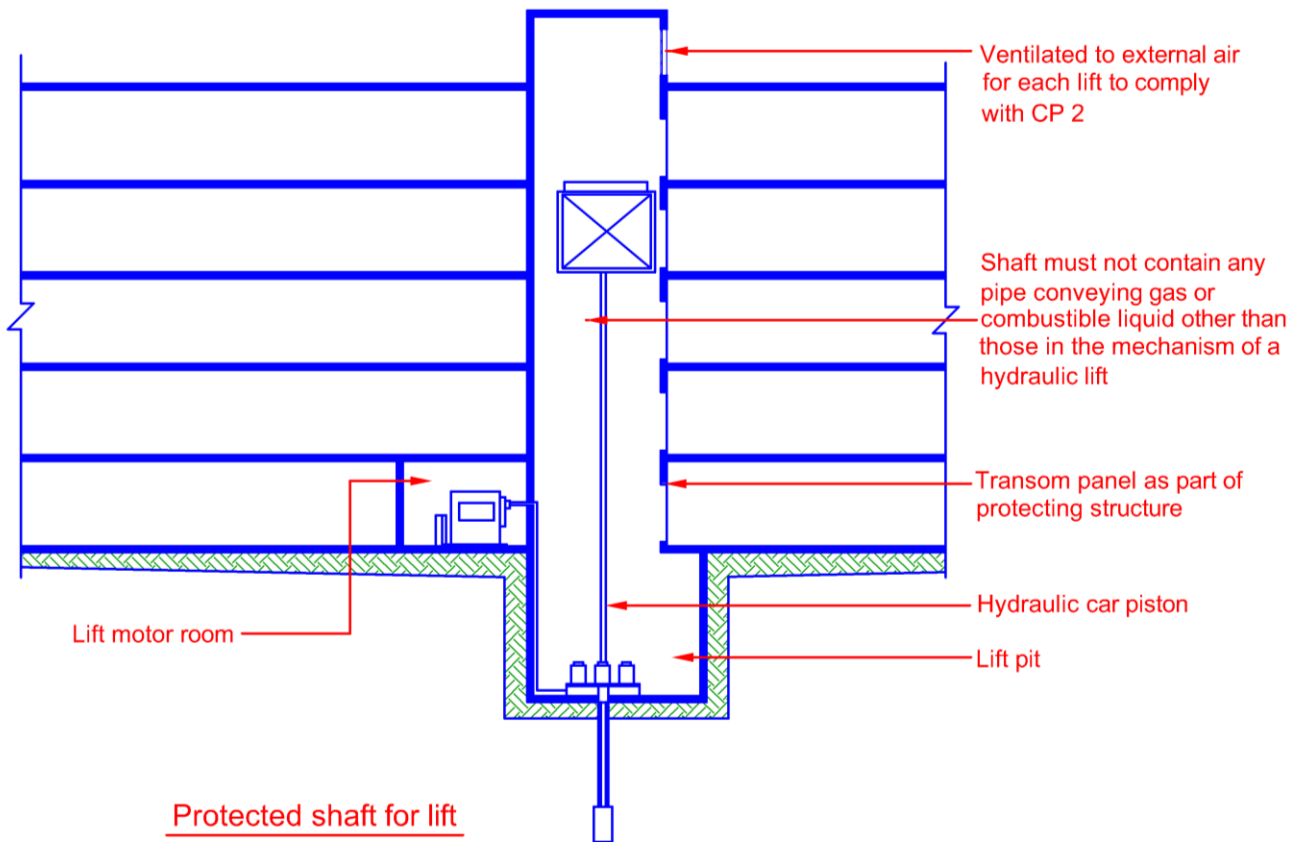

Diagram 3.8.8(a) & (b)-2

Lift shaft, which is not located at the edge of atrium floors or at the external wall outside the building, shall be constructed of masonry.

Sub-clause (a) above specifically permits combustible liquid in the mechanism of hydraulic lift. The liquid is concealed in vessels and forms part of the mechanical system to permit the homing of the lift during an emergency. The liquid has a high flash point of over 400°C.

(c) Where a lift is either located at the edge of atrium floors or at the external wall and outside the building, the lift shall be considered as not enclosed within a protected shaft.

**EXPLANATIONS & ILLUSTRATIONS**

**3.8.8**

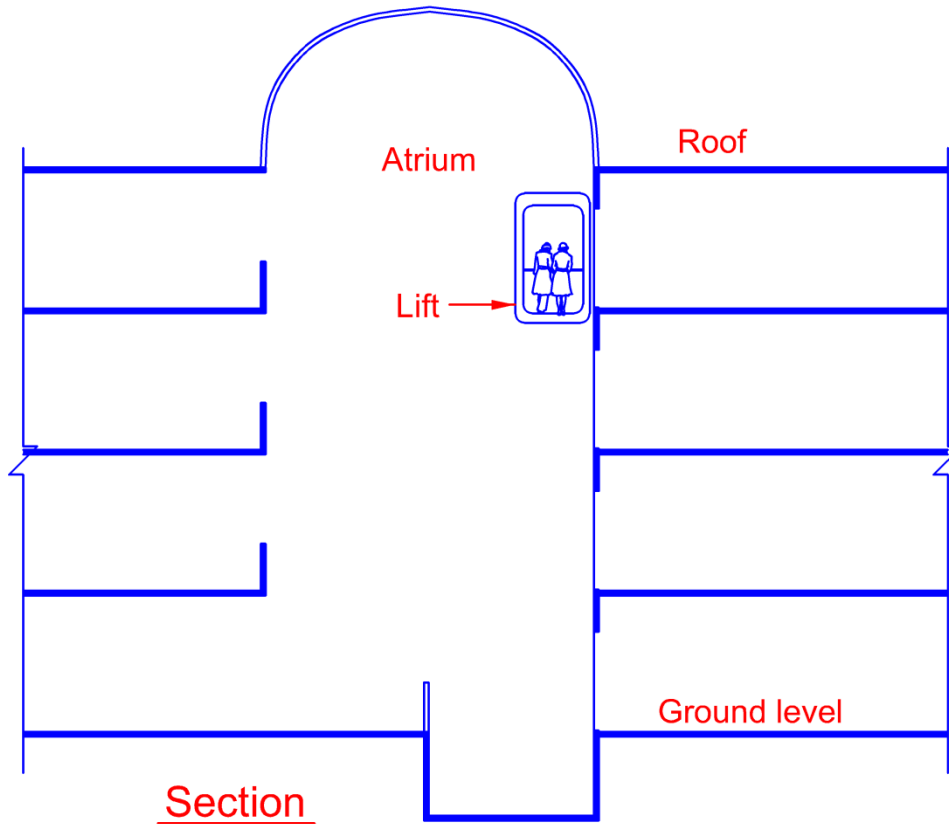

*Diagram 3.8.8(c)-1*

*In the above diagram the lift is unenclosed, being located within the atrium void. There is no penetration of any compartment floor and smoke migration caused by the 'piston-effect' of lift movement is no longer a concern. Smoke from a fire in any occupancy floor will flow from the ceiling layer into the atrium void where it will tend to rise upwards due to its natural buoyancy. A smoke control system would eventually extract the smoke out of the building*

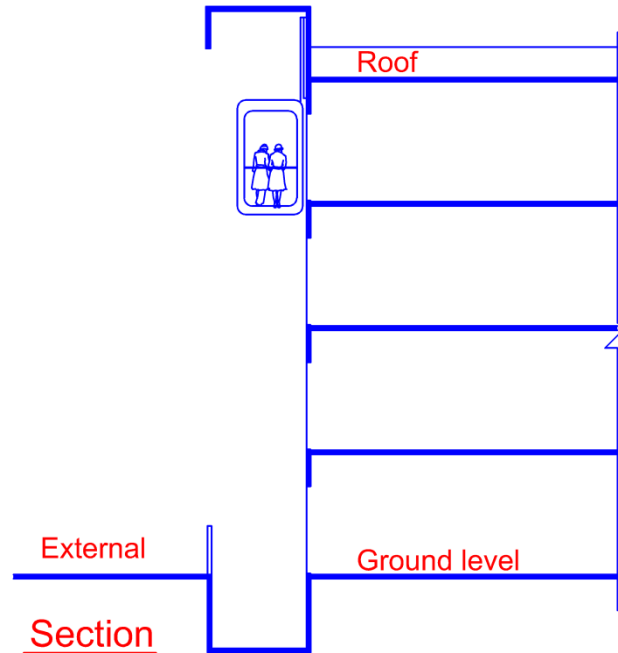

Diagram 3.8.8(c)-2

The lift is sited outside the external wall of the building. There is no concern of smoke and heat being transferred from floor to floor. Hence it is not required to be enclosed in a protected shaft. This type of lift is commonly known as 'bubble lift' or 'sky lift'.

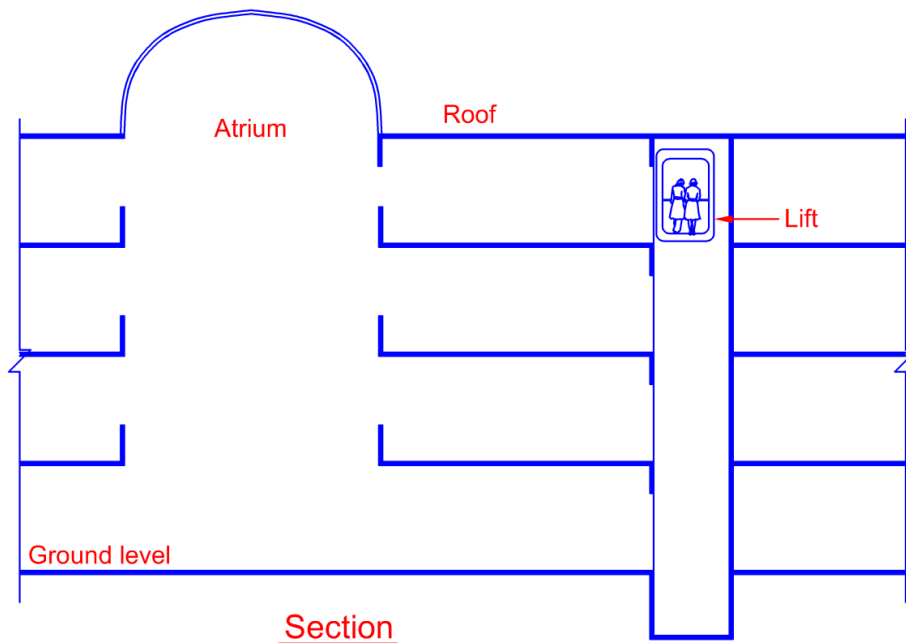

Diagram 3.8.8(c)-3

The above diagram shows that the lift is located away from the atrium void. As the lift punctures through the compartment floors, it must be enclosed in a protected shaft to prevent the spread of smoke and heat from floor to floor.

- (d) The protected shaft shall be vented in accordance with SS 550 Code of Practice for Installation, Operation and Maintenance of Electric Passenger and Goods Lifts. The vents shall be so arranged as to induce exhaust ventilation of the shaft. Where vents could not be provided because of the location of the lift shaft, ventilation duct protected by drywall complying with Cl.3.8.8(b) serving as ventilation of the shaft may be provided instead. If the duct is not to be fire rated, fire dampers shall be provided to the duct at the wall of the lift shaft, provided such relaxation shall not apply to shaft containing fire lift.
- (e) Openings for the passage of lift cables into the lift motor room located above or at the bottom of the shaft shall be as small as practicable.

## EXPLANATIONS & ILLUSTRATIONS

3.8.8(e)

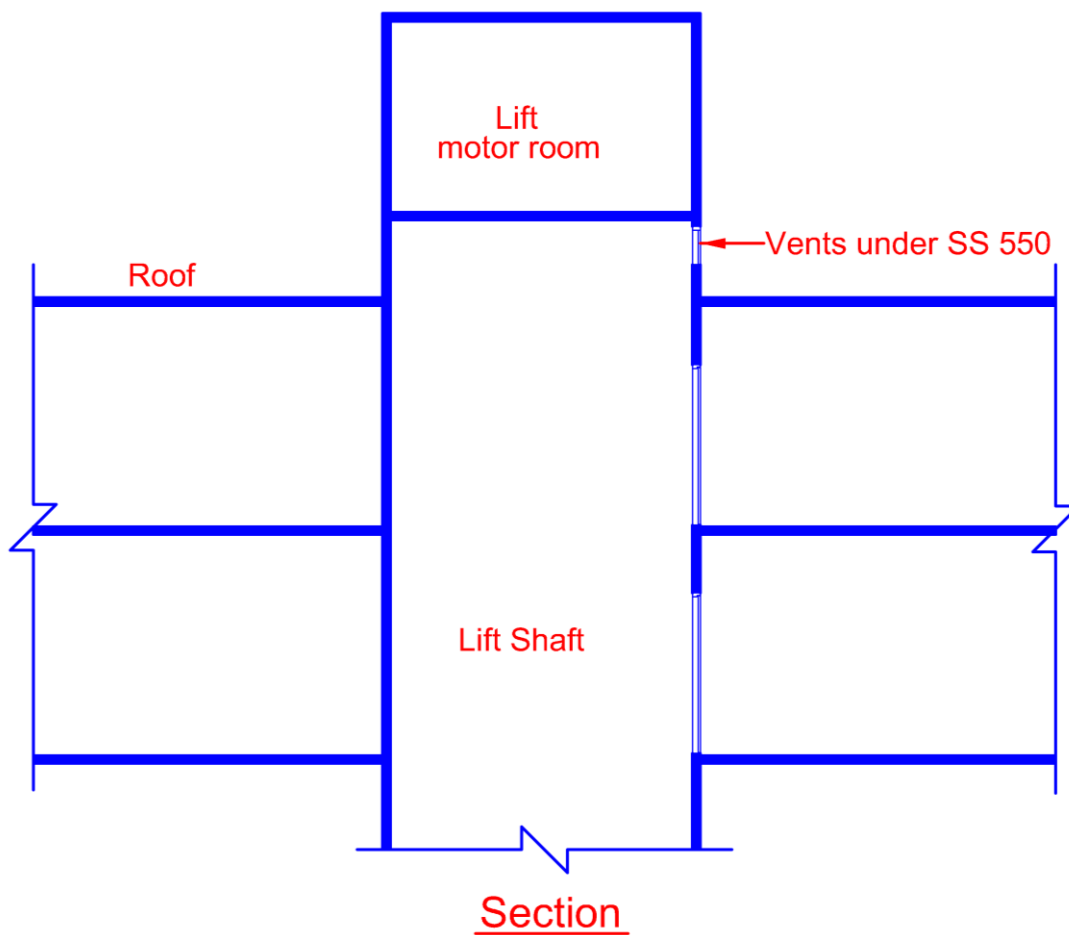

Diagram 3.8.8(e)-1

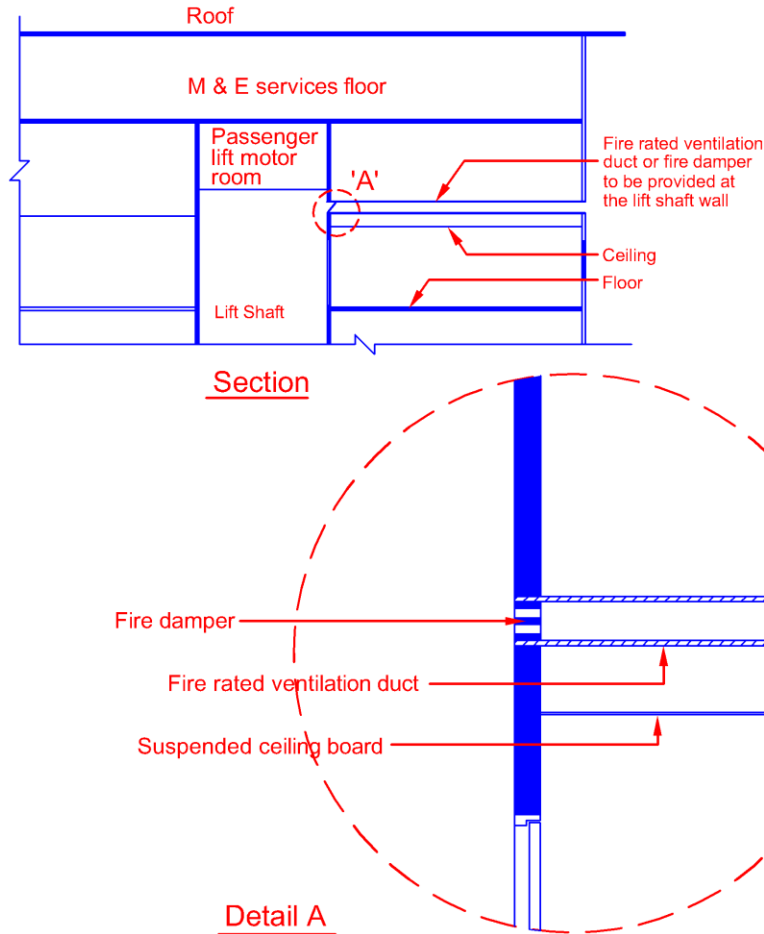

Diagram 3.8.8(e)-2

All lift shafts shall be vented at the top in accordance with SS 550. In situations, where the lift shafts could not be brought above the roof as shown in diagram 3.8.8(d) – 2, horizontal fire rated duct could be used to provide air relief to the lift shaft. If the duct is not fire rated, appropriate fire damper could be provided in the wall of the protected lift shaft as shown 'A' in the above diagram. The above relaxation shall not be applicable to fire lift.



- (f) Transom panel above lift entrance shall be considered as part of the protecting structure and shall therefore conform to the fire resistance requirements of the protected structure.

## EXPLANATIONS & ILLUSTRATIONS

3.8.8

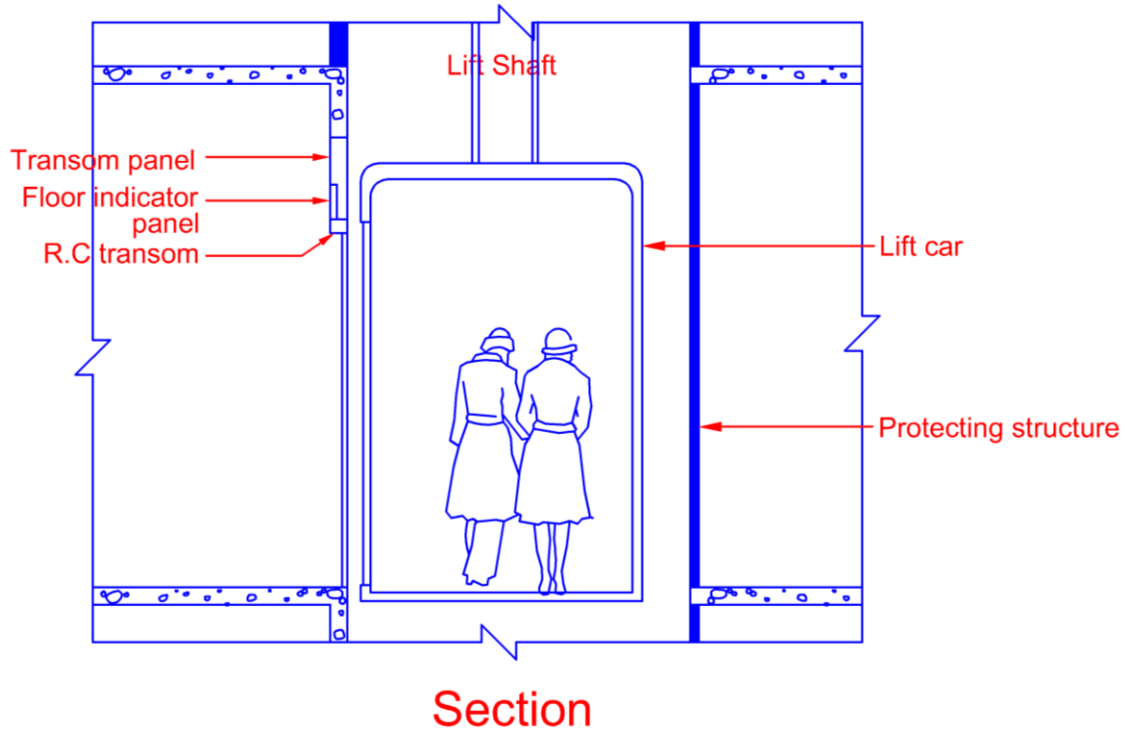

Diagram 3.8.8(f)

*Floor indicator panel should be surface mounted. If it is built into the transom panel, care should be taken to ensure that the fire resistance of the panel is not lowered. It is a common mistake to puncture the transom panel to receive the floor indicator panel without giving consideration to the fire integrity of the panel. Such practice contravenes the above requirement, as Cl.3.8.2 requires that the protecting structure, including the transom panel, forms a complete barrier and should have the appropriate fire resistance rating.*

- (g) If it serves any basement storey it shall be protected by a smoke-stop lobby with walls having 1 hour fire resistance and fire door of half-an-hour fire resistance. The protected lobby shall be mechanically ventilated.

Exception:

Where the lift landing area is adjoining an air-well or external space of minimum clear area 10m<sup>2</sup> and minimum width of 3m. The distance between the nearest edge of lift door opening to the air-well shall not exceed 3m.

**EXPLANATIONS & ILLUSTRATIONS**

**3.8.8**

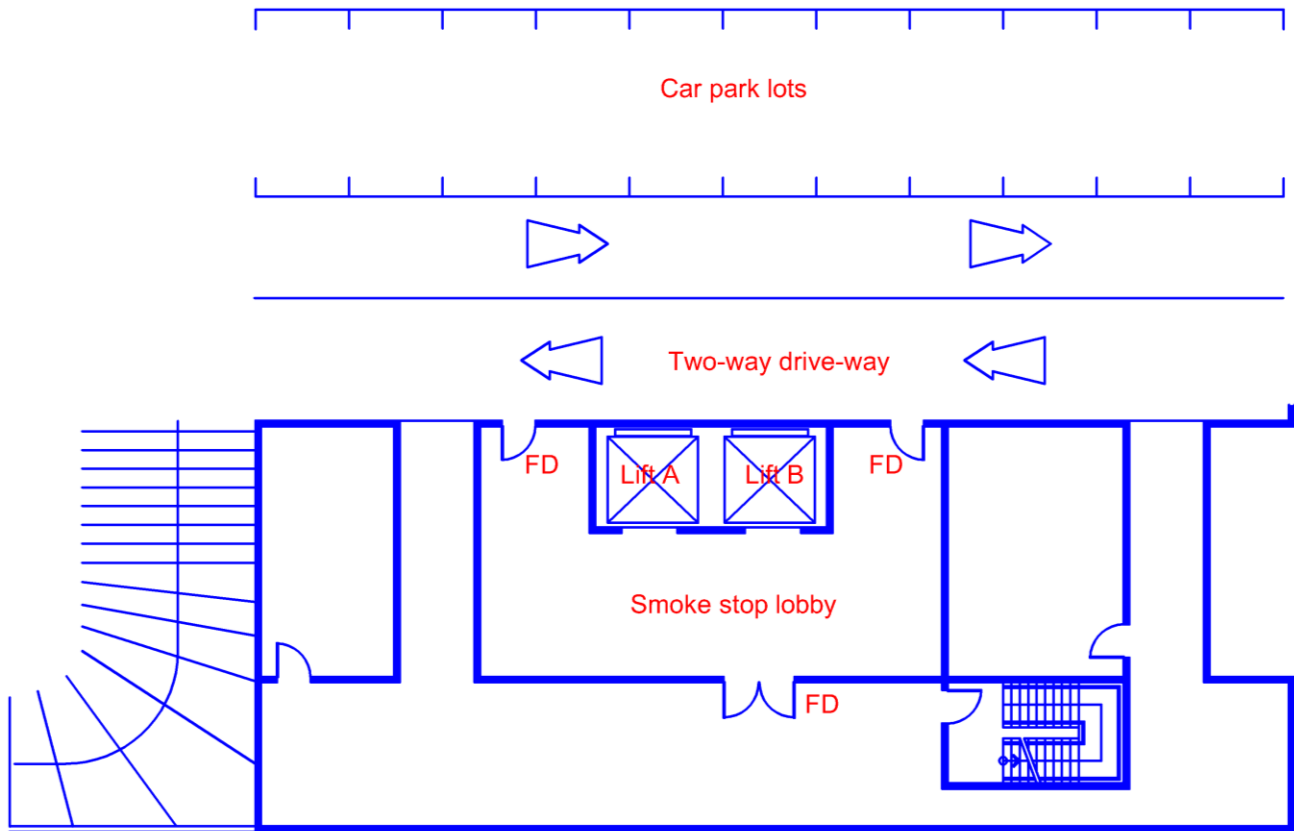

FD – Fire door

Plan

Diagram 3.8.8(g)-1

*Lift opening into basement and not adjoining a void that opens to the sky or any external spaces, shall be provided within a smoke stop lobby having 1-hour fire rated enclosures and ½ hour fire door.*

*The smoke-stop lobby acts as a buffer zone to prevent smoke from being drawn into the lift shaft through the ‘piston-effect’ of the movement of the lift.*

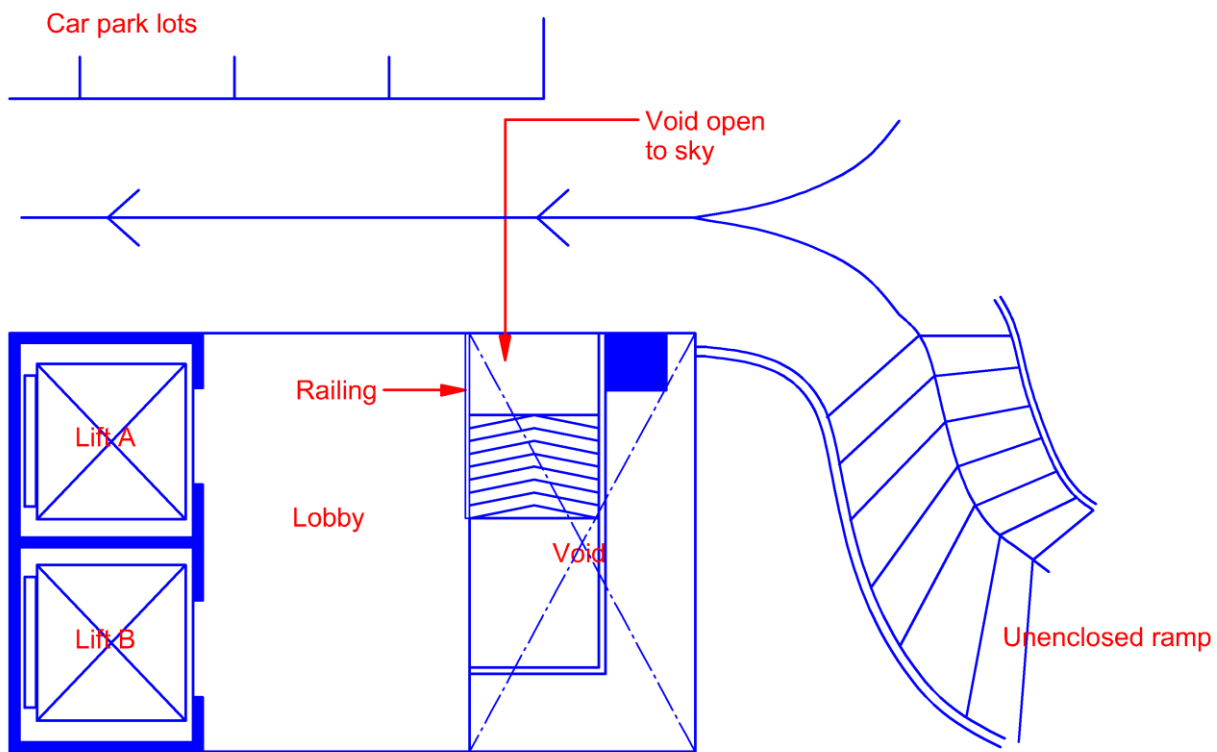

Basement floor plan

Diagram 3.8.8(g)-2

*Lift opening into basement storey and adjoining a void opening to the sky or any external spaces does not require a smoke-stop lobby. Smoke occurring in the vicinity of the lift would be drawn into the void and vented upward into the open space. This provision would help to reduce the chance of smoke being sucked into the lift shaft.*

(h) Private Lift

Private lifts that are provided for the exclusive use of occupants in residential units under purpose group II buildings shall comply with the following requirements :

- (i) Smoke detectors shall be provided at the lift landing area. The activation of any of the smoke detectors at the lift landing area shall cause the lift to home to the designated floor; and
- (ii) Emergency power supply from a generating plant shall be provided to home the lift to the designated floor when there is a power failure in the building; and
- (iii) The designated floor can either be on grade level or one level below grade level. If it is the latter, the lift shall home to a protected lobby, with direct access to an exit; and
- (iv) The lift shall not be permitted to double-up as a fire lift; and
- (v) Private lifts shall comply with SS 550.

**EXPLANATIONS & ILLUSTRATIONS**

**3.8.8**

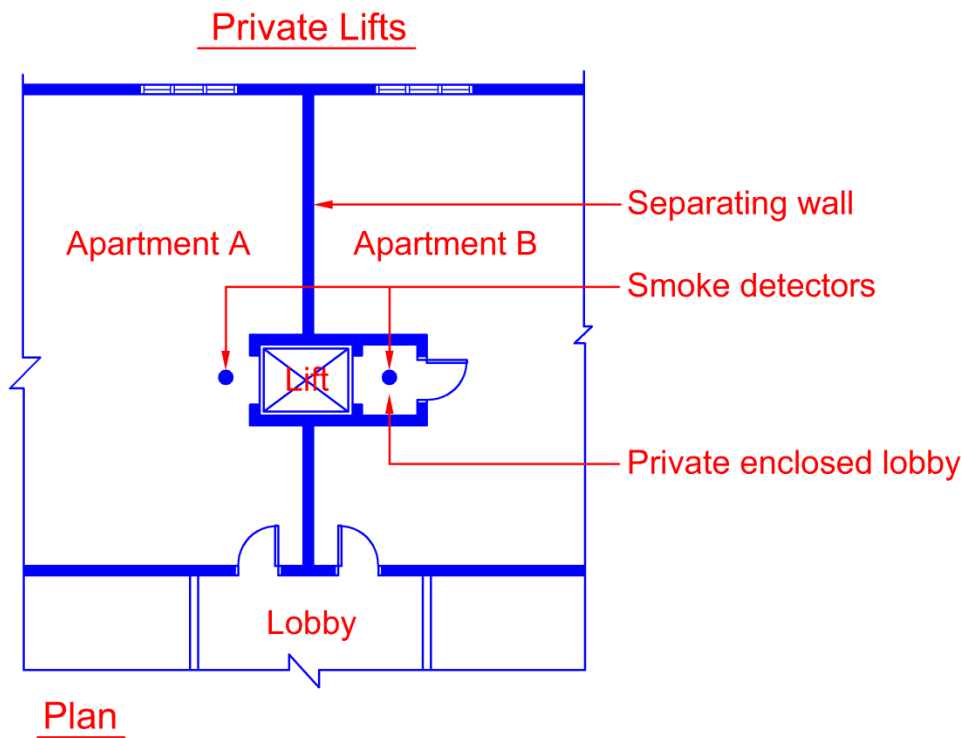

*Diagram 3.8.8(h)-1*

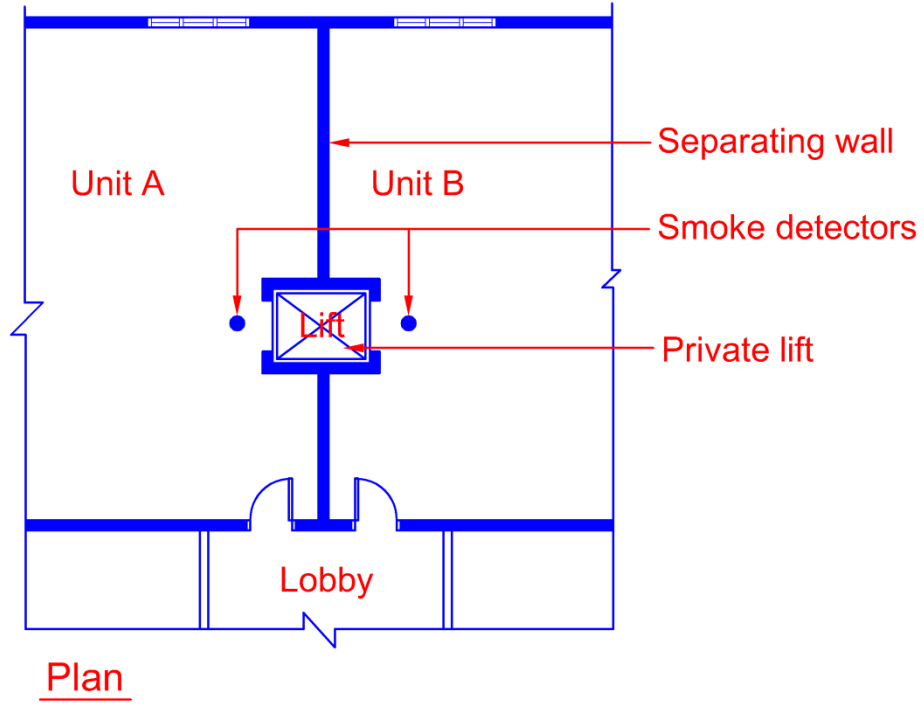

Diagram 3.8.8(h)-2

# CHAPTER 3

## 3.8 PROTECTED SHAFTS

### 3.8.9 Protected shaft containing other services installations

A protected shaft used for the enclosure of services shall comply with the following:

- (a) The protecting structure for protected shaft containing kitchen exhaust ducts and mechanical ventilation ducts serving areas specified in C1.5.2.1(g)(i) to (iii) and (h) which pass through one or more floor slabs shall be of masonry or drywall. Such shaft shall be completely compartmented from the rest of the shaft space containing other ducts or any other services installations. Protected shaft containing ducts serving other areas which pass through two or more floor slabs shall be constructed of drywall. If the protecting structure for the protected shaft is constructed of drywall, the following conditions shall be complied with :
  - (i) Drywall shall be non-combustible; and
  - (ii) Drywall shall have fire resistance for not less than the relevant period specified in Table 3.3A having regard to the purpose group of the building of which it forms a part and the dimension specified in that Table; and
  - (iii) Drywall shall meet the criteria, in terms of impact and deflection performance, when subject to the tests of BS 5588 Pt 5 Appendix A and BS 5234 Pt 2; and
  - (iv) Drywall shall meet the criteria, in terms of water absorption and bending strength; and performance, when subject to the test of BS EN 520 (for gypsum plaster board) or ISO 1896 (for calcium silicate or cement board).

### EXPLANATIONS & ILLUSTRATIONS

*The protecting structure for protected shaft containing kitchen exhaust duct and mechanical ventilation ducts which pass through one or more floors and serving areas such as:*

- (i) *exit staircases and exit passageways*
- (ii) *Smoke-stop and fire fighting lobby*
- (iii) *Areas of refuge within the same building*
- (iv) *Emergency generator*
- (v) *Engine driven fire pump*

*shall be constructed in masonry. Each shaft shall be separately compartmented from one another. Protected shaft containing ducts serving other areas not mentioned above and which pass through two or more floors can be constructed of fire rated materials, instead of masonry.*

(i)

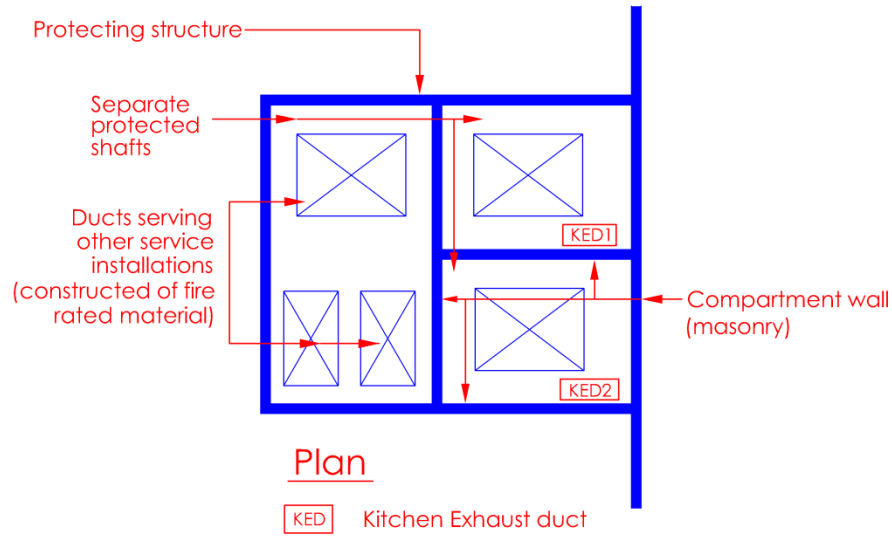

Diagram 3.8.9(a)-1

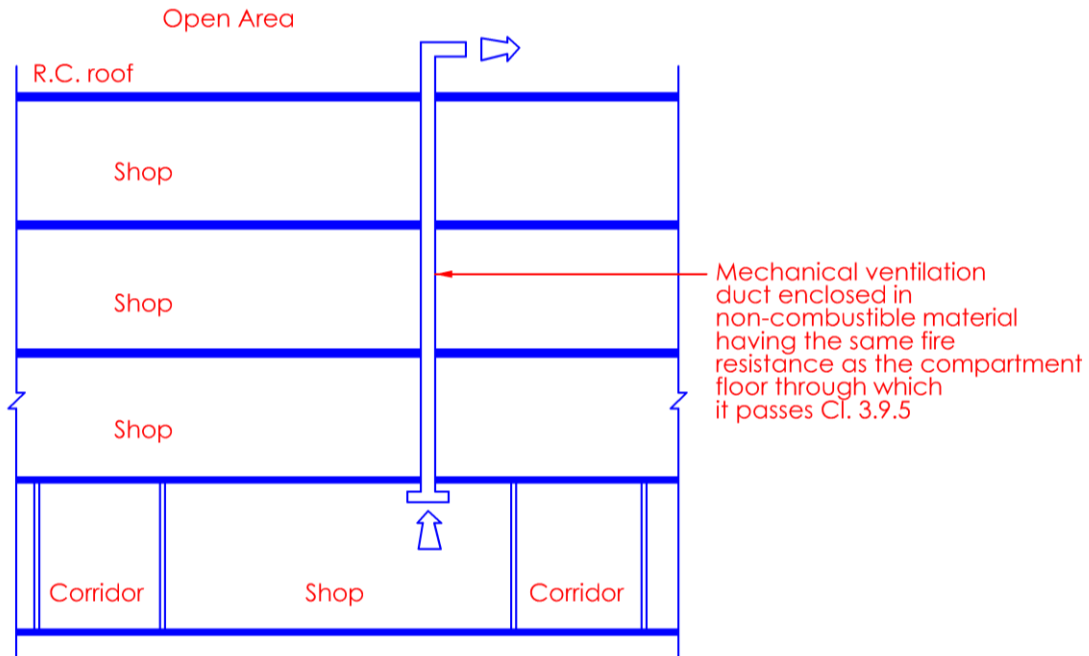

Diagram 3.8.9(a)-2

*E.g. Kitchen exhaust duct shall be in a separate compartment from that for a mechanical ventilation duct. Kitchen exhaust ducts serving different kitchens shall be in separate shafts. Mechanical ventilation duct serving the area of refuge shall be in different shaft from that serving the pump room. The main reason for separate shafts is to prevent smoke and fire spread from shaft to shaft.*

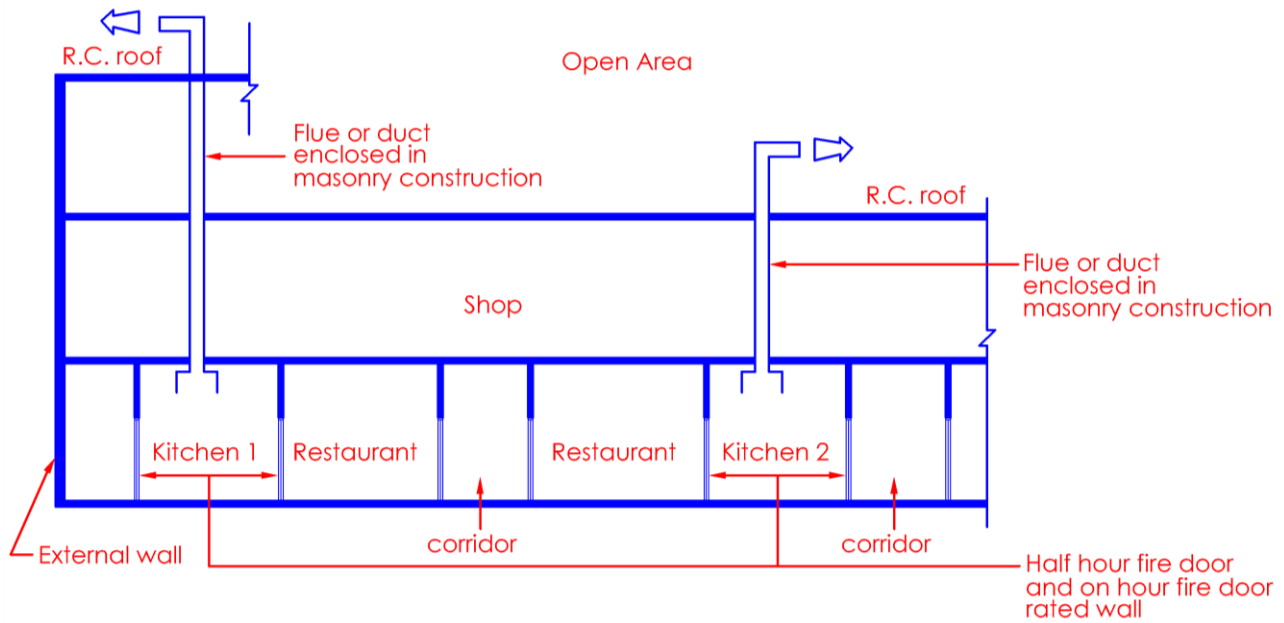

Diagram 3.8.9(a)-3

- (a) In the above diagram, the roof is not considered a floor slab, as it is exposed to the external air. Hence, the flue or duct does not pass through the floor. (See Kitchen 2)
- (b) When the flue or duct passes through one or more floors. (any floor) It shall be encased in masonry material to ensure stability and prevent mechanical damage. (See Kitchen 1)



(ii)

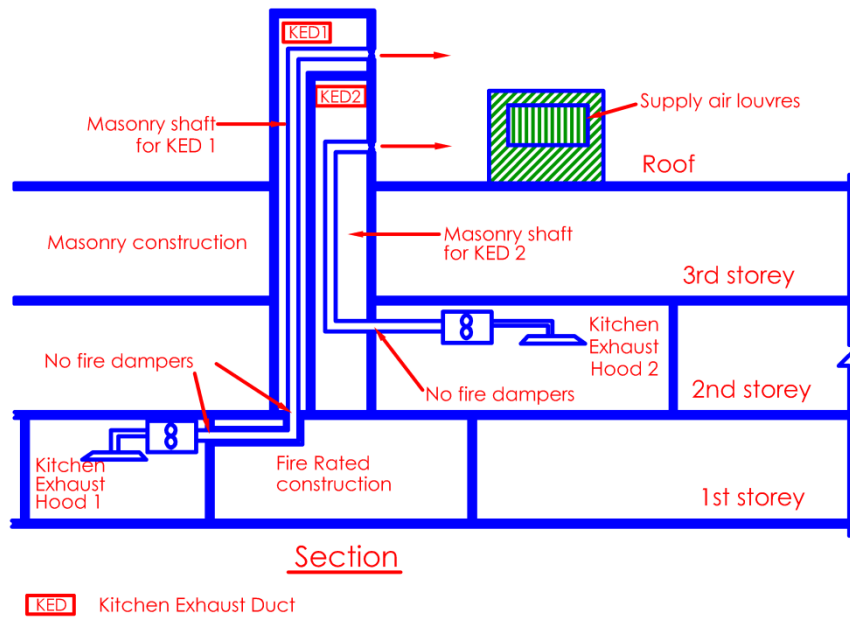
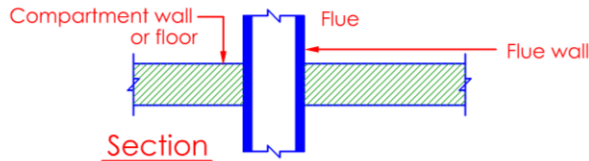

Diagram 3.8.9(a)-4

*Kitchen exhaust shaft for each kitchen is completely separated. The horizontal run of the exhaust from kitchen 1 is protected with fire rated material.*

a. Flue passing through compartment wall or floor



Flue walls should have a fire resistance of at least one half of that required for the compartment wall or floor, and be of non-combustible construction

b. Flue built into compartment wall

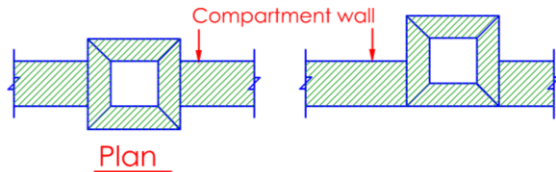

In each case flue walls should have a fire resistance of at least one half of that required for the compartment wall and be of non-combustible construction

Diagram 3.8.9(a)-5

*If a flue, or duct containing flues or appliance ventilation duct(s), passes through a compartment wall or compartment floor, or is built into a compartment wall, each wall of the flue or duct should have a fire resistance of at least half that of the wall or floor in order to prevent the by-passing of the compartmentation.*

- (b) Protected shaft used for the enclosure of electrical power services shall be interrupted at every floor level with barriers with fire resistance of at least half an hour. Protected shaft used for the enclosure of telecommunications cables shall be interrupted by barriers with fire resistance of at least half an hour at vertical intervals not exceeding 15m. Such cavity barriers shall comply with the relevant provisions of Cl.3.11.

**EXPLANATIONS & ILLUSTRATIONS**

**3.8.9(b)**

(i)

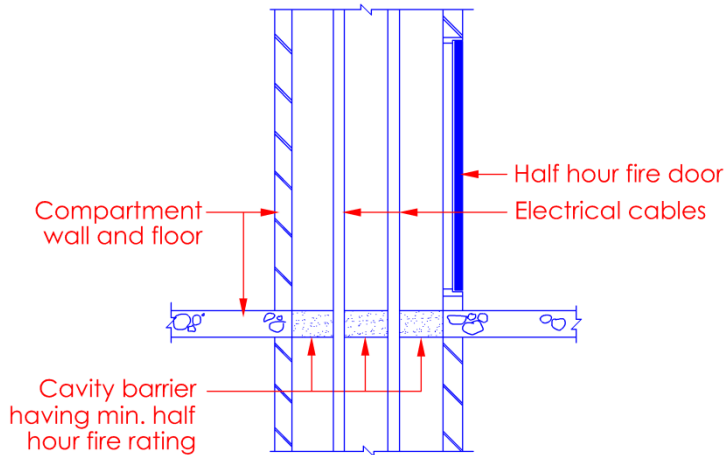

Diagram 3.8.9(b)-(i)

Protected shaft containing electrical cables shall be interrupted at every floor with cavity barrier having min. 1/2 hour fire rating to prevent vertical spread of fire and smoke. The main concern is that cables are a source of fuel and ignition. The presence of fire stopping at every floor would help to confine fire to a single storey or segment of the shaft.

(ii)

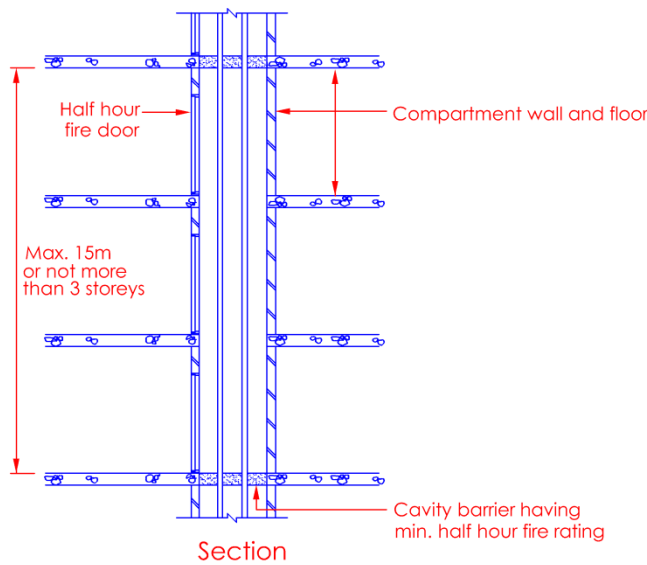

Diagram 3.8.9(b)-(ii)

Protected shaft containing telecommunications cables including cable TV lines is provided with cavity barrier at vertical intervals not exceeding 15m or 3 storey whichever is the shorter. The cables are mainly of low voltage and hence of a lower risk when compared to electrical cables.

(c) Omission of self-closing devices

In the case of protected shafts which are interrupted by barriers with fire resistance of at least half an hour at every floor level or protected shafts containing sanitary pipes or water pipes, fire resisting doors opening into the protected shaft are not required to be installed with automatic self-closing devices, provided such doors are kept closed and locked at all times.

**EXPLANATIONS & ILLUSTRATIONS**

**3.8.9(c)**

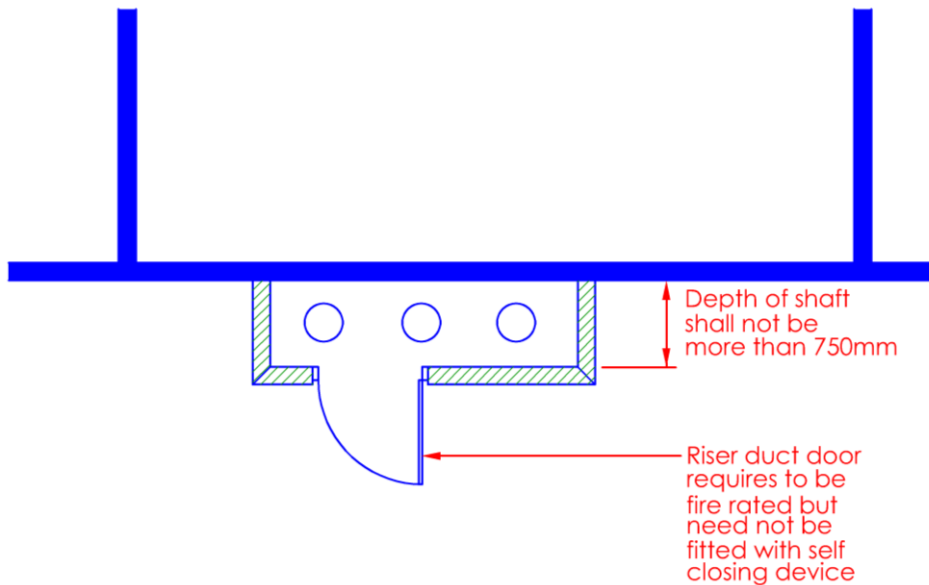

Diagram 3.8.9(c)

*Provision of self-closing device for the inspection door of a protected shaft, which is interrupted by barriers having 1/2-hour fire resistance at every floor level, is not required. The above relaxation is also applicable to TAS shafts, provided they are interrupted by barriers with fire resistance of at least 1/2-hour at every floor level.*

*An important point to note is the depth of the shaft which shall not exceed 750mm. If it exceeds 750mm, the shaft would be considered as a room and provision of self-closing device for the fire door becomes a necessity. The above relaxation is based on the understanding that it is unlikely that a shaft would be converted to a store if its depth is less than 750mm and that the door would normally be kept in the locked position when workmen are not carrying out servicing work. Also, maintaining the door in locked position is the responsibility of the management corporation of the estate.*

(d) Exception

All protected shafts containing services shall not be located within an exit staircase except for the case of residential apartment/maisonette development under Purpose Group II not exceeding 4-storey where smoke-stop lobby is not required.

**EXPLANATIONS & ILLUSTRATIONS**

**3.8.9(d)**

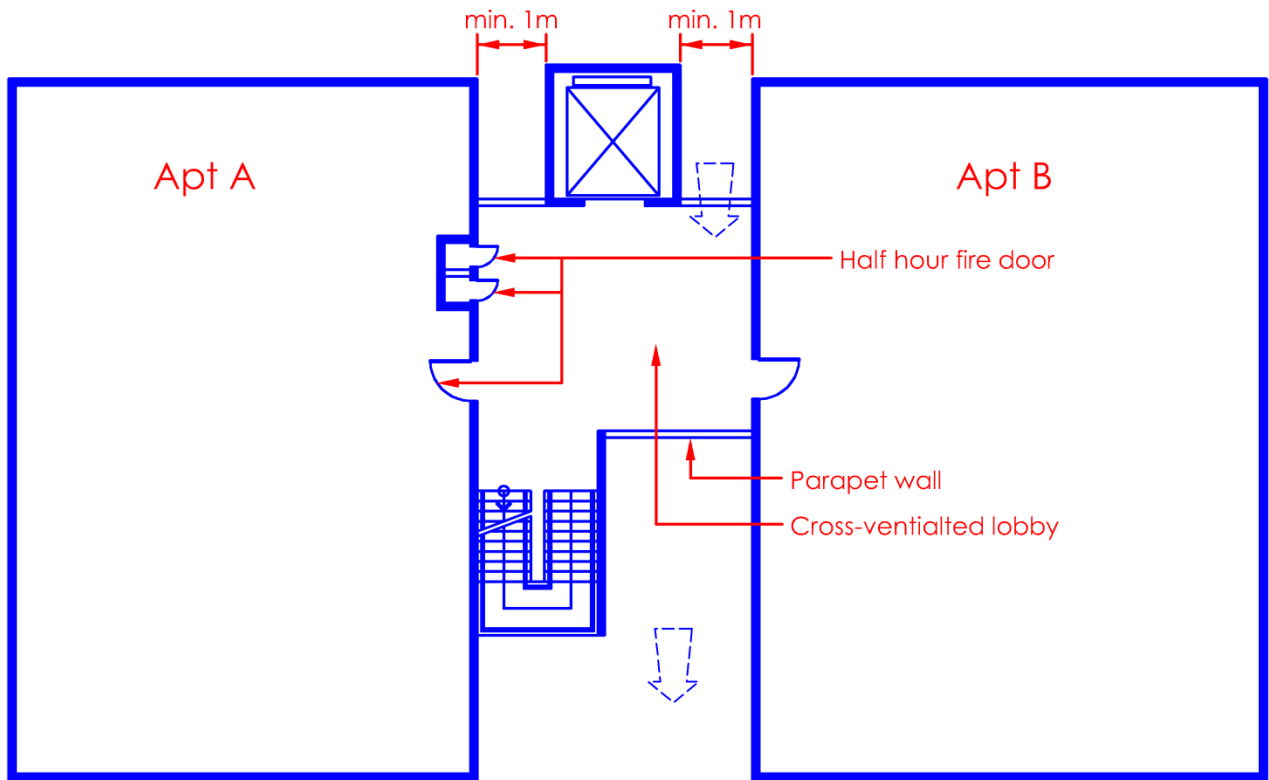

*Diagram 3.8.9(d)-1*

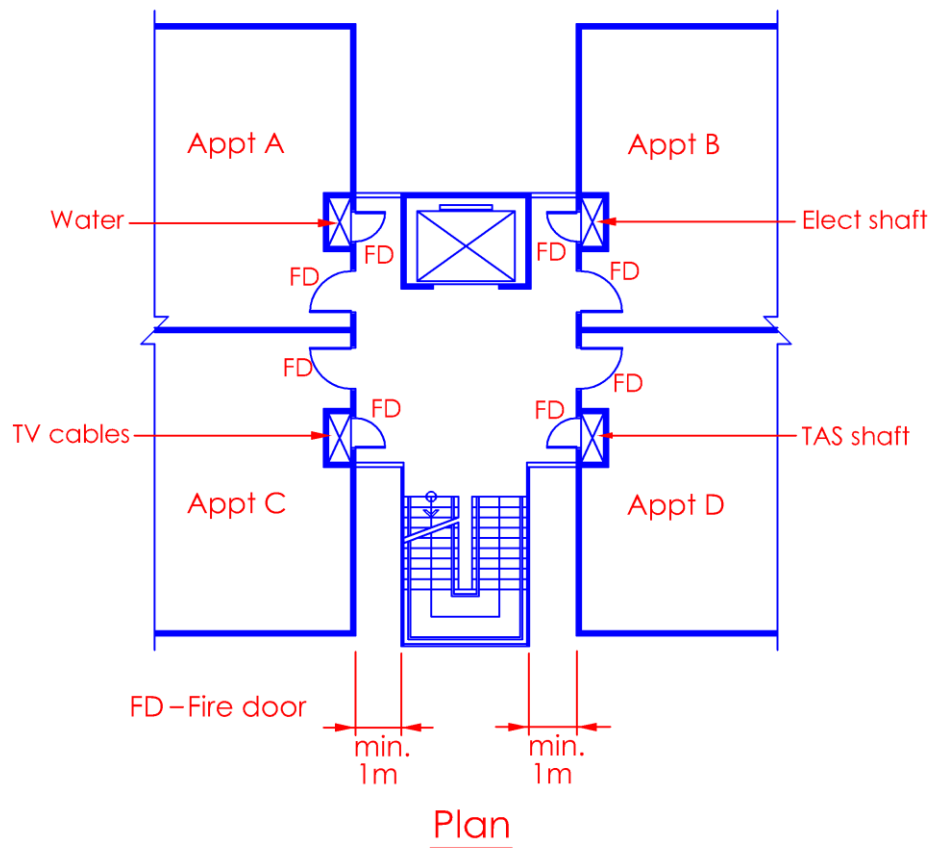
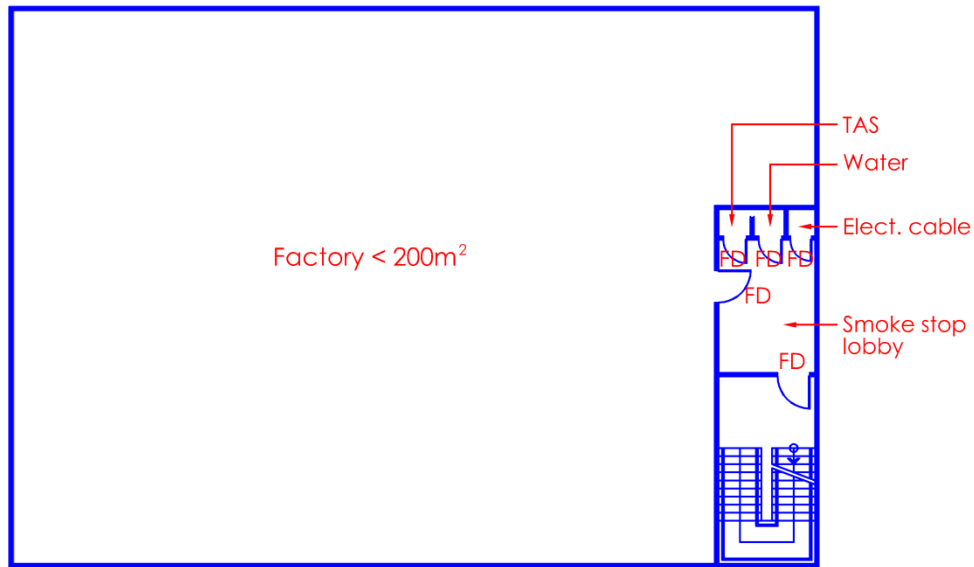

Diagram 3.8.9(d)-2

Protected shafts such as for lift, TAS/Elect/Water/Cables are permitted to be located within a protected shaft containing an exit staircase for buildings under Purpose Group II, provided :

- a) that building does not exceed 4 storey where provision of smoke stop lobby is not a requirement; and
- b) that no shaft shall contain pipes carrying gas or combustible liquids. The above exception is only applicable to low-rise buildings where provision of smoke stop lobby is not a requirement and that the staircase would be naturally ventilated. However, where there is availability of common area, such services shall be located outside the staircase shaft, see diagram 3.8.9(d) – 2.



FD - Fire door

Plan

Diagram 3.8.9(d)-3

A factory or warehouse building which does not require the provision of smoke stop lobby to exit staircase by virtue of its height shall be required to comply fully with the above requirement. All protected shafts containing services are located in a common lobby adjoining the exit staircase.

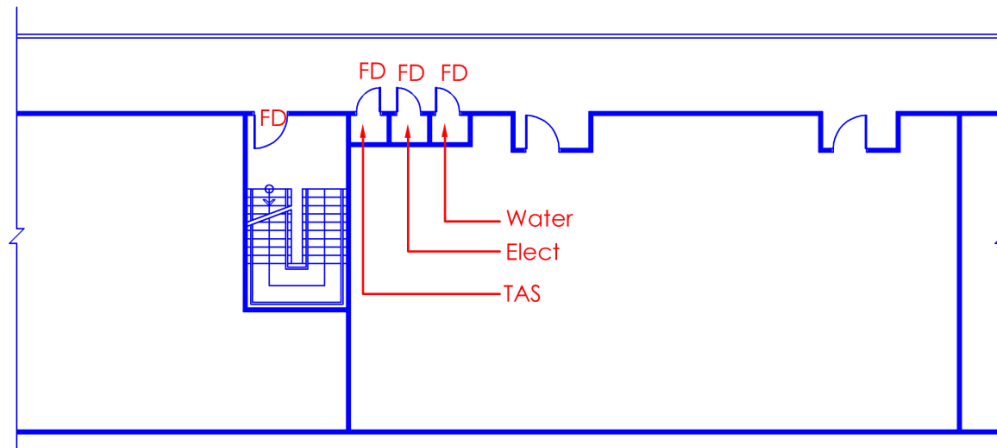

FD - Fire door

Plan

Diagram 3.8.9(d)-4

Although the services are enclosed in protected shafts, they are not permitted to be located in exit staircase. The main reasons are :

- Within the protected shaft, the combustible materials eg. Cables PVC pipes are source of fire risk. A fire could originate from these combustible materials and spread into the exit staircase enclosure.
- Exit staircase is a dedicated route for escape of occupants, services which are not serving the staircase shall not be located inside the enclosure.

# CHAPTER 3

## 3.9 PROTECTION OF OPENINGS

### 3.9.1 Application

The provisions of this Clause are made in connection with the protection of openings permitted in elements of structure or other forms of fire resisting construction required to act as a barrier to fire and smoke.

### EXPLANATIONS & ILLUSTRATIONS

*(No illustration)*

*For functional purposes, openings in compartment walls, floor etc are required in buildings to allow movement of people and the installation of services such as pipes, ventilation ducts etc. To prevent the spread of fire and smoke, such openings shall be appropriately protected.*

# CHAPTER 3

## 3.9 PROTECTION OF OPENINGS

### 3.9.2 Fire doors

Fire doors for protection of openings shall comply with the following:

- (a) Fire doors shall have the appropriate fire resistance as required by relevant parts of the Code, and two fire doors may be fitted in an opening if each door by itself is capable of closing the opening and the two doors together achieve the required level of fire resistance, and

### EXPLANATIONS & ILLUSTRATIONS

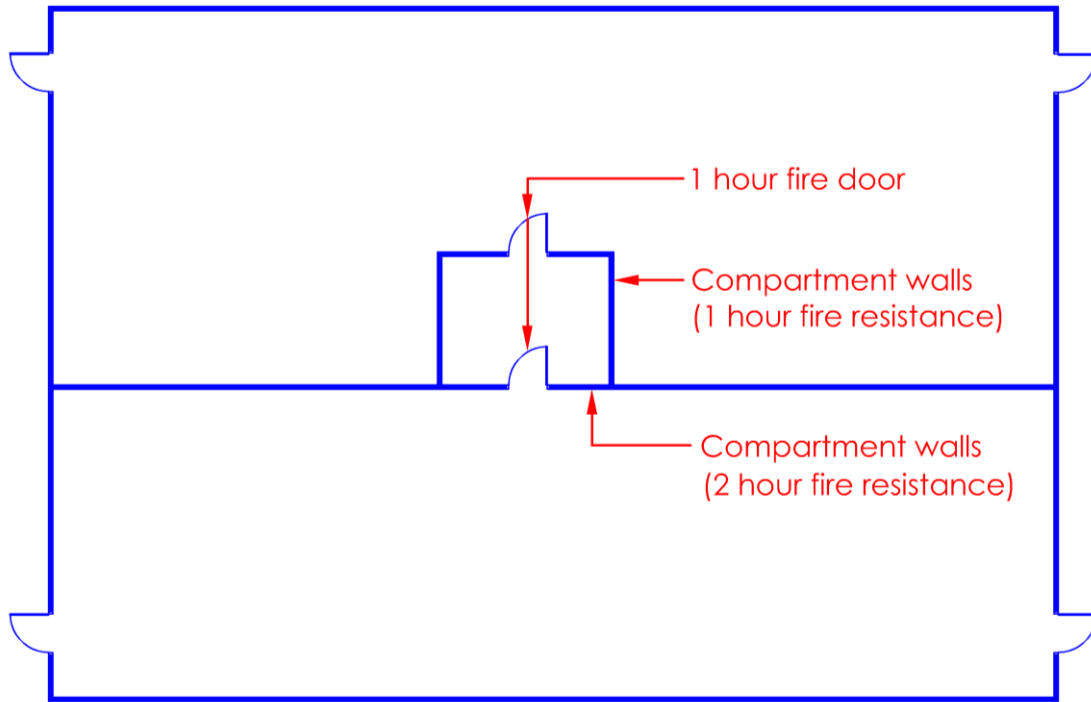

Plan

Diagram 3.9.2(a)-1

*The two 1 hour fire door arrangement is deemed to satisfy compartmentation and be equivalent to the fire resistance rating of the compartment wall (2 hours).*



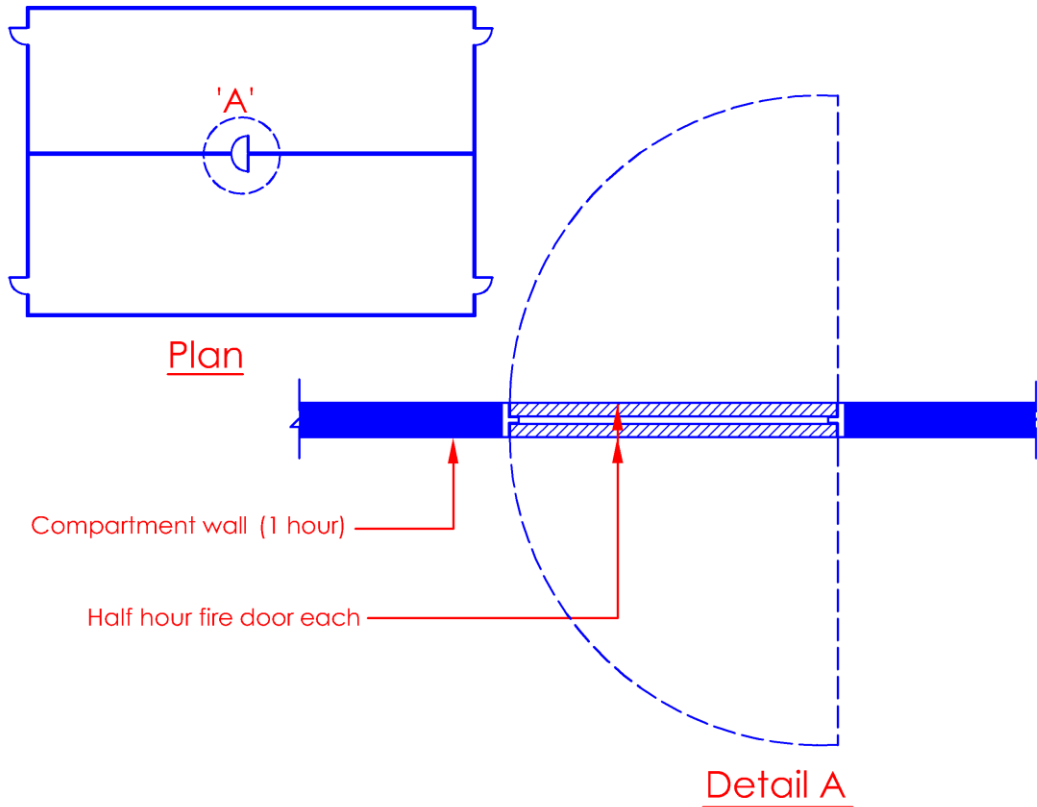

Diagram 3.9.2(a)-2

*The provision of fire doors shown in the above diagram usually occur in separating walls, compartments e.g. hotel guestrooms or protecting structures / dormitories, hostel bedrooms or protecting structures.. The 2 doors shall be independent of each other and having its own door frame. However, the 2 doors may share the same door frame only if that set of door is tested to achieve the required rating. This arrangement shall not form part of the escape exit route.*

- (b) All fire doors shall be fitted with an automatic self-closing device which is capable of closing the door from any angle and against any latch fitted to the door. The omission of the self-closing device to the bolted door leaf of a 2-leaf door is acceptable if the door is the entrance door to a residential unit under Purpose Group II.

## EXPLANATIONS & ILLUSTRATIONS

3.9.2

*No illustration.*

*All fire doors are required to be fitted with an automatic self-closing device which shall not include rising butt. Self-closing device is not required to be fitted to doors of protected shafts having a depth of not more than 750mm under sub-clause 3.8.9(c).*

*Fire resisting door to exit openings of apartment/maisonette units, protected staircases, protected lobbies, exit passageway, compartment walls etc. shall have minimum half hour fire resistance. Doors to exit facilities shall not be fitted with any locking device. However, doors to exit openings of apartment/maisonette units would be fitted with locking devices for security reasons. As fire door is to protect the openings in exit facilities, it should always remain in the closed position to prevent the spread of smoke and heat. The main function of the self-closing device is to return the door to its closed position after being opened for movement of occupants, goods etc. The passage latch fitted to the door is to hold the fire door in closed position to counteract the pressure differential between the door in a fire situation.*

*Many private residential apartment/maisonette buildings have card key access or automatic locking devices fitted to doors of exit staircases to prevent unauthorised access by outsiders.*

*To gain entry into the staircase or to exit from it into any floor, the occupants need to key in a code number or use a card key access to unlock or release the locking device to the door. In times of power failure or activation of fire alarm system, if available, the locking device would be unlocked by itself and all the exit doors could be opened manually. Prior approval should be obtained from FSSD before any door to exit facilities is fitted with any form of locking device.*

*When the door to the exit facilities consists of double leaves or multiple leaves, all the leaves shall be fitted with self-closing device and sequential closer.*

*Where the entrance door of the apartment or maisonette unit consists of large and small leaves, self-closing device shall be required to be provided to the large leaf, provided the clear width of the opening of the large leaf when open at an angle of 90° is not less than 850mm. The smaller leaf is not to be taken into consideration as it would usually be bolted-shut, unless there is a need to open it for movement of large furniture, etc. If the door opening has 2 leaves of equal width for use as exit to meet the minimum clear width of opening under Cl.2.2.9(b), both leaves shall be fitted with self-closing device and sequential door closer.*

*Self-closing device to fire door shall be properly maintained regularly. Faulty device shall be repaired immediately to prevent fire door being left in the open position.*

(c) Where a self-closing device would be considered a hindrance to the normal use of the building, fire doors may be held open as follows :

(i) by a fusible link, or

(ii) if the doors can be opened manually, by electromagnetic or electro-mechanical devices which can be activated by the presence of smoke and/or the building alarm system,

**EXPLANATIONS & ILLUSTRATIONS**

**3.9.2**

*See illustration in Cl.1.2.20*

(d) Any hinge on which a fire door is hung shall be of the type approved under the product listing scheme, and

**EXPLANATIONS & ILLUSTRATIONS**

**3.9.2**

*No illustration.*

- (e) Any fire door fitted in an opening which is provided as a means of escape:
  - (i) shall be capable of being opened manually, without the use of key, tool, special knowledge or effort for operation from the inside of the building; and
  - (ii) shall not be held open by any means other than by an electromagnetic or electro-mechanical device which can be activated by the presence of smoke and/or the building alarm system, provided that this shall not apply in the case of fire doors opening into pressurised exit staircases.
  - (iii) shall open in the direction of exit travel in accordance with Cl.2.3.9.

<b>EXPLANATIONS &amp; ILLUSTRATIONS</b>
---

<b>3.9.2</b>
--------------

*See illustration in Cl.1.2.20*

(f) Fire doors where required to be provided shall be constructed and installed to comply with specifications stipulated under SS 332 Specification for Fire Doors.

**EXPLANATIONS & ILLUSTRATIONS**

**3.9.2(f)**

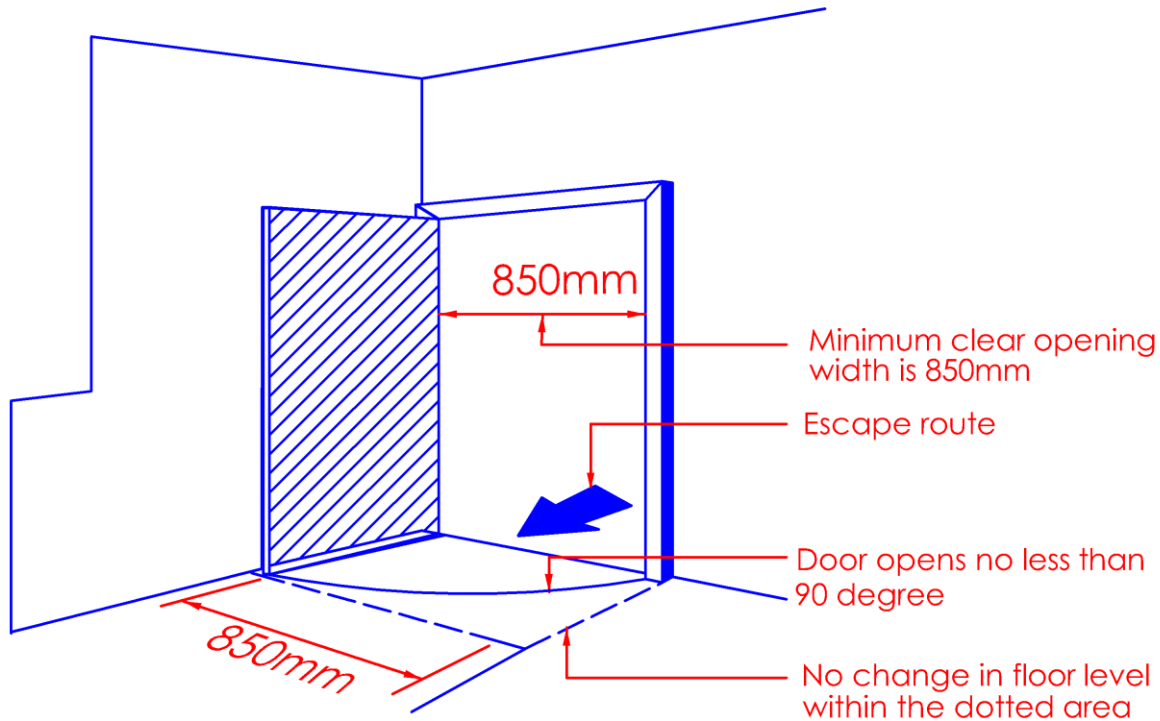

*Diagram 3.9.2(f)*

*All fire doors are required to be listed under a recognized certification body. It is important to note that fire door opening into pressurised exit staircases shall not be fitted with electromagnetic or electro-mechanical device. This is to ensure that the integrity of the pressurised exit staircase is maintained at all times.*

# CHAPTER 3

## 3.9 PROTECTION OF OPENINGS

### 3.9.3 Pipes

- (a) Pipes which pass through a separating wall, compartment wall or compartment floor shall be kept as small as possible and fire-stopped around the pipe. The nominal internal diameter of the pipe shall be not more than the relevant dimension given in Table 3.9A. Spacing between pipes shall be minimum 50mm or 1/2-diameter of the largest pipe, whichever is the larger.
- (b) Routing of gas pipes in basements
  - (i) All gas pipes that are routed in basement shall be API pipes with welded joints. These joints shall be 100% radiography checked in accordance with sub-clause 3.4.2(h) of SS CP 51. The gas pipes are not required to be fire rated if they are running outside essential areas such as exit staircases, smoke stop or fire fighting lobby, fire pump room, generator room, fire command centre, etc. If they run into essential area, they are required to be encased in masonry.
  - (ii) For mechanically ventilated basement, the gas pipes shall be provided with pipe sleeves for the venting of gas pipes. One end of the sleeve shall be exposed to the external as specified in sub-clause 3.4.2(g) of SS CP 51.
  - (iii) For naturally ventilated basement that complies with sub-clause 6.4.1(d)(iii)(b), the provision of pipe sleeve is not required.

### EXPLANATIONS & ILLUSTRATIONS

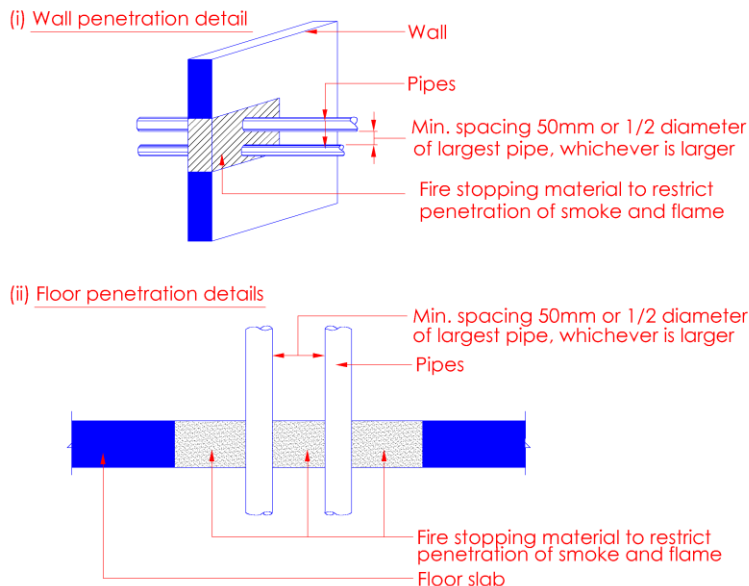

Diagram 3.9.3-1

*The clustering of pipes without proper spacing would further weaken the integrity of the fire resisting walls in times of fire emergency.*

*Penetration of elements of structure by pipes*

All openings as small as possible and fire stopped

Separating or compartment wall

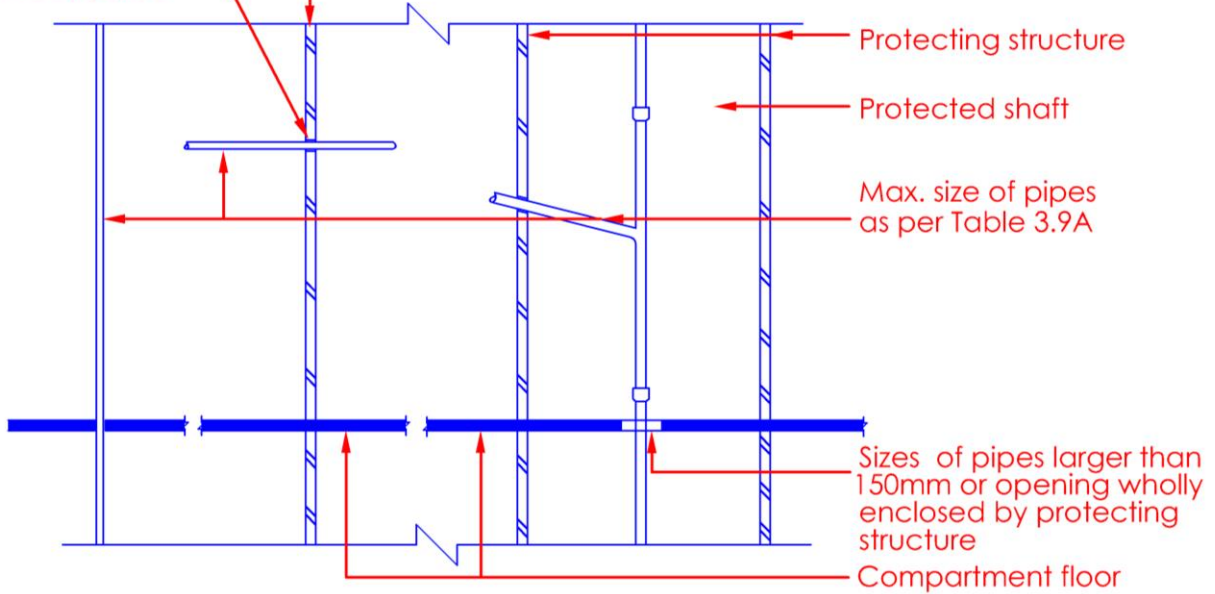

Section

Diagram 3.9.3-2

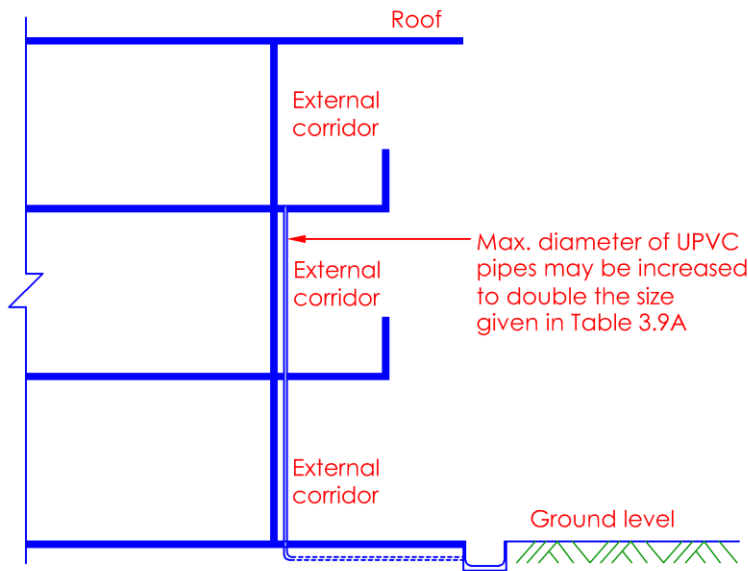

Section

Diagram 3.9.3-3

*External corridor would be well ventilated. Hence fire risk is lower and the threat of spread of fire and smoke from floor to floor is very much reduced.*



**TABLE 3.9.3A****TABLE 3.9A MAXIMUM NOMINAL INTERNAL DIAMETER OF PIPES**

Situation	Pipe material and maximum nominal internal diameter [mm]		
	Non-combustible material	Lead, aluminium or aluminium alloy, or UPVC <sup>2</sup>	Any other material
When the pipes penetrate the structure enclosing a protected shaft which is not an exit stairway or lift shaft	150	100	40
Any other situation	150	100 (stack pipe) <sup>3</sup> 75 (branch pipe) <sup>3</sup>	40

## Notes

- 1) A non-combustible material (such as cast iron or steel) which if exposed to a temperature of 800 degrees Celsius will not soften nor fracture to the extent that flame or gases will pass through the wall of the pipe.
- 2) UPVC pipes complying with SS 141 or SS 213.
- 3)
  - (i) Within toilets, wash rooms or external corridors, maximum diameter of UPVC pipes may be increased to double the size given in the above table.
  - (ii) Within areas of fire risk, such as kitchens, and adjacent to escape routes, UPVC pipes shall be enclosed by construction having fire resistance of at least one half hour.
  - (iii) Where the size of UPVC pipes exceeds that specified under this Clause, approved fire collar shall be fitted at all positions where such pipes pass through constructions required to act as a barrier to fire.
- “Any other situation” refers to separating wall, compartment wall/floor and other similar construction.

**EXPLANATIONS & ILLUSTRATIONS****Table 3.9.3A**

*Table 3.9A lists three specifications which control the max. internal diameter of the pipes which penetrate elements of structure as follows:*

*a) 150mm diameter pipes of non-combustible material*

*Pipes which will not soften or crack sufficiently to permit passage of hot gases or flames when exposed to temperatures up to 800°C. If the pipe size exceeds 150mm, it shall be located within a protected duct or shaft*

*b) 100mm diameter (stack) and 75mm diameter (branch) pipes*

*Pipes of lead, aluminum or alloy and UPVC (complying to SS 141 or SS213) which would soften or crack sufficiently to permit passage of hot gases or flames when exposed to temperature below 800°C. Pipes of lead, aluminum or alloy exceeding 100mm diameter (stack) and 75mm diameter (branch) shall be located within a protected shaft or duct. UPVC pipes located in areas of fire risk such as kitchens or adjacent to escape routes shall be enclosed in protecting structure having min. 1 hour fire resistance rating or following that of the elements of structure, whichever is greater.*

*UPVC pipes located in other areas exceeding the sizes of 100mm (stack) or 75mm (branch) shall be fire stopped by approved fire collar at penetration of elements of structure.*

*Exception:*

*Internal diameter of UPVC pipes located within toilets, wash rooms which are considered as “wet area” and in external corridor may be double that given in Table 3.9A*

*c) 40mm diameter pipe*

*Pipes of any other material shall not exceed 40mm unless located in protected duct or shaft.*

# CHAPTER 3

## 3.9 PROTECTION OF OPENINGS

### 3.9.4 Ventilation ducts

Ventilation duct which passes directly through a compartment wall or compartment floor shall comply with the following –

- (a) Where the ventilation duct does not form a protected shaft or is not contained within a protecting structure,
  - (i) the duct shall be fitted with a fire damper where it passes through the compartment wall or compartment floor, and
  - (ii) the opening for the duct shall be kept as small as practicable and any gap around the fire damper shall be fire-stopped.

### EXPLANATIONS & ILLUSTRATIONS

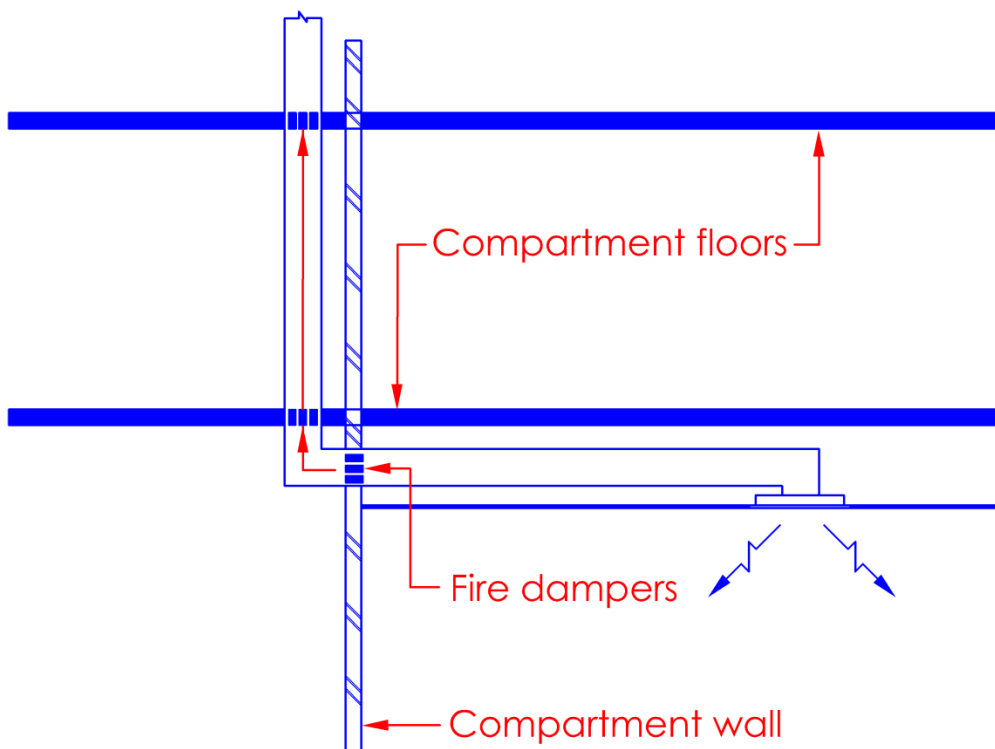

Diagram 3.9.4 (a)

*Proper fire stopping around the duct where it penetrates the compartment floor/wall and provision of fire damper at the compartment wall/floor would help to prevent fire and smoke spread from compartment to compartment.*

- (b) Where the ventilation duct forms a protected shaft or is contained within a protecting structure, the duct shall be –
- (i) fitted with fire dampers at the inlets to the shaft and outlets from it, and
  - (ii) constructed and lined with materials in accordance with the requirements in Chapter 7.

**EXPLANATIONS & ILLUSTRATIONS**

**3.9.4(b)**

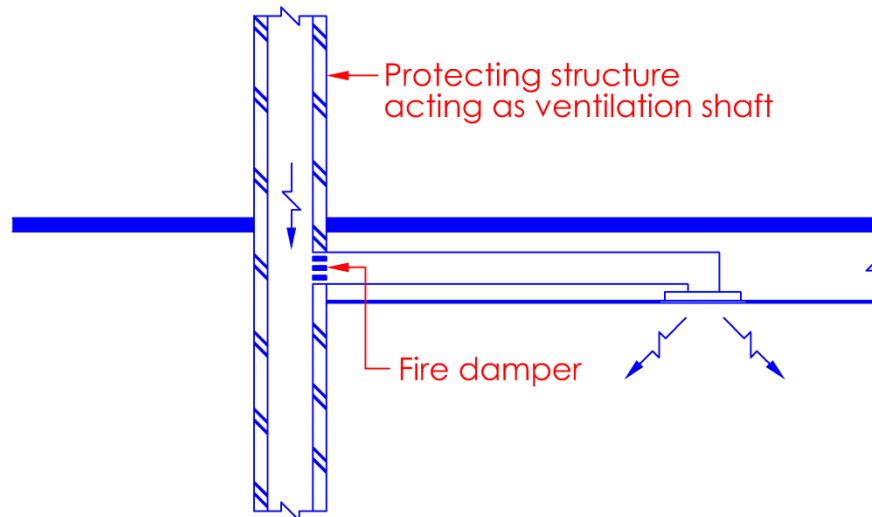

*Diagram 3.9.4 (b)*

*The provision of fire damper at the entry to the protected shaft would help to complete the compartmentation to prevent fire or smoke from being drawn into the protected shaft via ventilation duct.*

(c) The installation of ventilation ducts and fire dampers shall comply with the requirements in Chapter 7.

**EXPLANATIONS & ILLUSTRATIONS**

**3.9.4**

*No illustration.*

# CHAPTER 3

## 3.9 PROTECTION OF OPENINGS

### 3.9.5 Flues

Duct encasing one or more flue pipes which passes through a compartment wall or compartment floor shall be of non-combustible construction having fire resistance of not less than half the minimum period of fire resistance required for the compartment wall or compartment floor through which it passes, except for kitchen flue pipes when the fire resistance shall be as required for the compartment wall or compartment floor.

### EXPLANATIONS & ILLUSTRATIONS

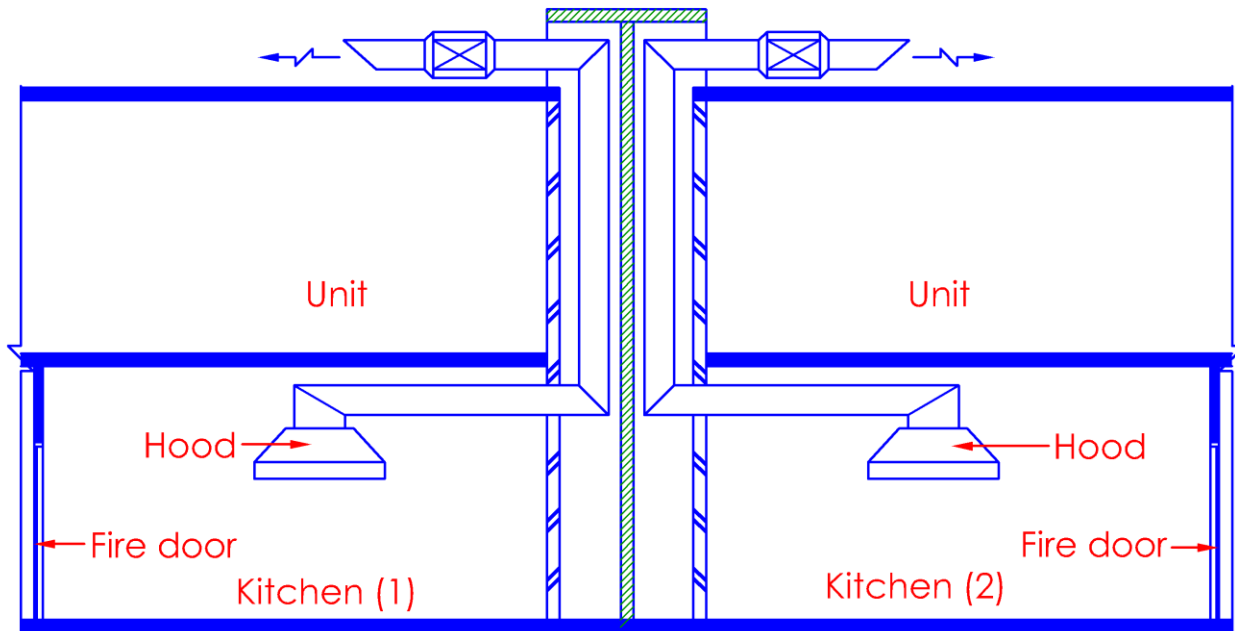

*Drawing 3.9.5-1*

*Separate kitchen exhaust shaft enclosed in masonry or drywall construction shall be provided for Kitchen (1) and (2). This is to prevent fire and smoke from spreading from one compartment to another. The wall enclosing the shaft shall have the same fire resistance as the compartment wall or floor.*

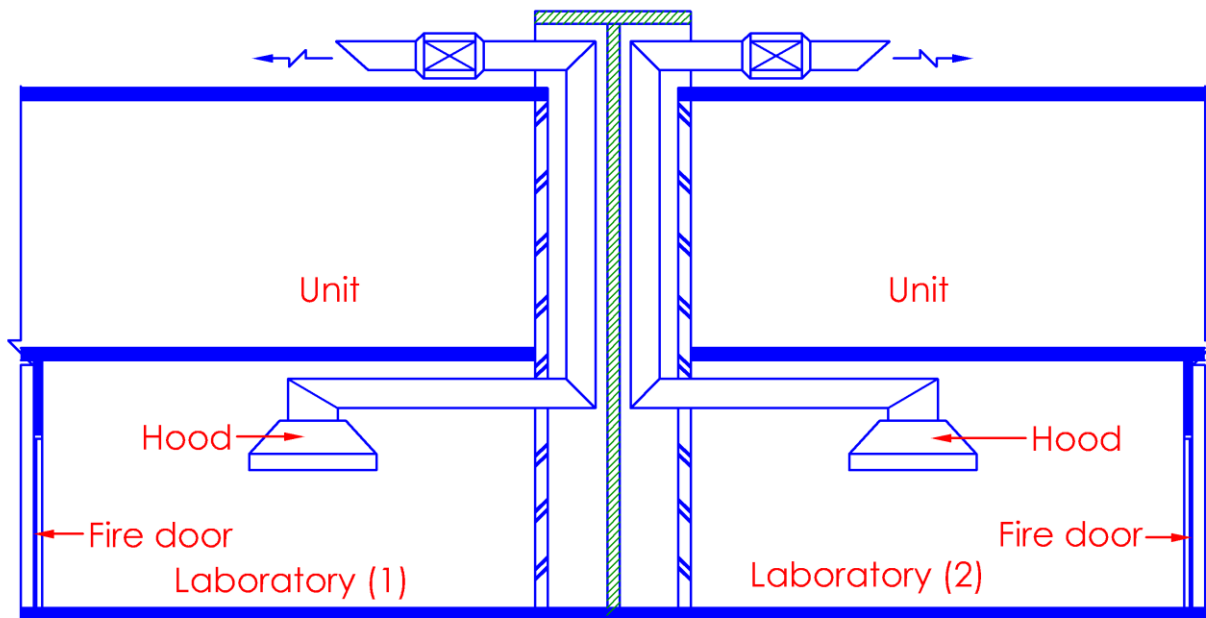

*Drawing 3.9.5-2*

*The enclosing walls to the duct serving the laboratory are required to be constructed of non-combustible materials, instead of masonry, and need to have not less than ½ the minimum period of fire resistance rating of the compartment walls or floor through which the duct passes.*

# CHAPTER 3

## 3.9 PROTECTION OF OPENINGS

### 3.9.6 Services passing through Fire Command Centre, Fire Pump Room, Emergency Generator Room and Smoke Control Fans Room

(a) Air ducts, sanitary pipes, gas pipes, electrical conduits/cable tray and other services that are likely to permit passage of flame or smoke in the event of a fire shall not be permitted to pass through the following spaces:

- (i) Fire Command Centre;
- (ii) Fire Pump Room;
- (iii) Emergency Generator Room;
- (iv) Smoke Control Fans Room.

except where such services are required for the operation of these equipment.

### EXPLANATIONS & ILLUSTRATIONS

*No illustration.*

*Services not forming part of the Fire Command Centre, Fire Pump Room, Emergency Generator Room and Smoke Control Fans Rooms but routed inside the mentioned spaces are disallowed. In the case of site constraint, the services not required for the operation of the mentioned system shall be separated and encased with masonry construction,*



(b) Services running inside and/or passing through fire-fighting lobby & smoke-stop lobby

Air ducts, sanitary pipes, gas pipes, electrical conduits/cable tray, and other services, excluding lifts, that are likely to permit passage of flame or smoke in the event of a fire shall not be permitted to run inside and/or pass through:

- (i) fire-fighting lobby;
- (ii) smoke-stop lobby.

unless all these services are protected with 1 hour fire resistance enclosure, or separated with 1 hour fire resistance ceiling from the said lobby. If these services are required for the operation of the above lobbies, they need not be separately protected.

**EXPLANATIONS & ILLUSTRATIONS**

*No illustration.*

*Where the services need to be routed inside fire-fighting lobby and smoke-stop lobby, adequate protection must strictly be adhered to. The unprotected services are required to be protected with 1 hour fire resistance enclosure, or separated with 1 hour fire resistance ceiling from the protected lobby space,*

# CHAPTER 3

## 3.10 EXIT STAIRCASES

### 3.10.1 Non- combustibility of structure

Every exit staircase, including the treads/risers and landing, shall be constructed of non-combustible materials. The exception is for buildings under Purpose Group I, where only the stringer or structures supporting the treads/risers and landing shall be constructed of non-combustible materials.

### EXPLANATIONS & ILLUSTRATIONS

*No illustration.*

# CHAPTER 3

## 3.10 EXIT STAIRCASES

### 3.10.2 Structure separating exit staircase

The exit staircase shall be separated from other parts of the building by a masonry structure or drywall complying with Cl.3.8.7(c) which shall have fire resistance for not less than the period required by Cl.3.3 for Elements of Structure.

### EXPLANATIONS & ILLUSTRATIONS

*No illustration.*

*The exit staircase shall be separated away from all unprotected spaces and openings. For more details of separation distance for unprotected openings, please refer to cl.2.3.3*

# CHAPTER 3

## 3.10 EXIT STAIRCASES

<b>3.10.3 Exit Doors</b>	
Doors opening into the exit staircase shall have fire resistance of at least half an hour and fitted with automatic self-closing device.	
<b>EXPLANATIONS &amp; ILLUSTRATIONS</b>	
<i>No illustration.</i>	

# CHAPTER 3

## 3.10 EXIT STAIRCASES

### 3.10.4 Finishes

Finishes to the ceilings/walls and floors of exit staircase shall be of non-combustible materials.

### EXPLANATIONS & ILLUSTRATIONS

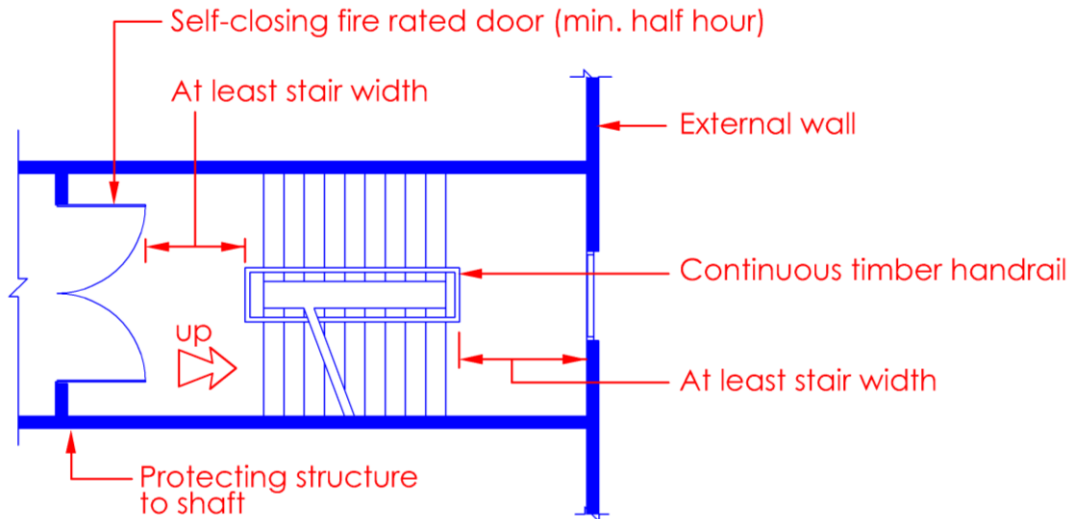

Diagram 3.10.4

*The protecting structure, excluding the external wall, to the staircase shall be constructed of non-combustible materials. Ceiling/wall and floor finishes shall be of non-combustible materials to ensure that the level of safety in the staircase is maintained at all times. The only exception allowed is the handrail material.*

# CHAPTER 3

## 3.11 CONCEALED SPACES

### 3.11.1 General provision

Concealed spaces in a building shall be interrupted by construction of cavity barriers to restrict the spread of smoke and flames.

### EXPLANATIONS & ILLUSTRATIONS

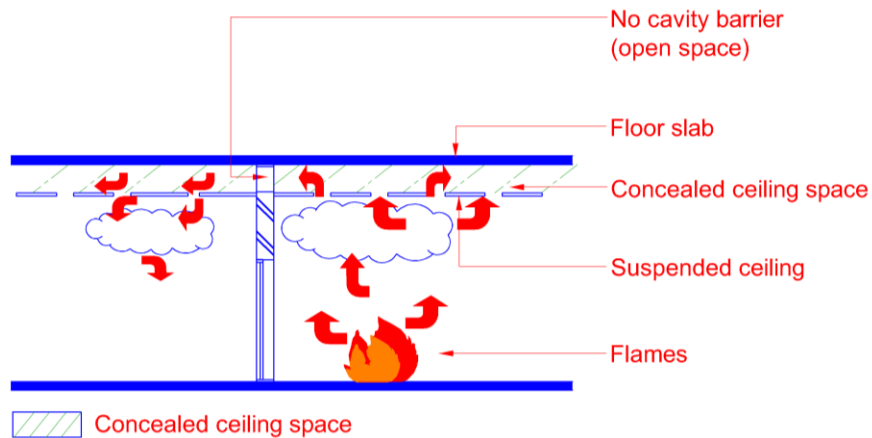

Diagram 3.11.1-1

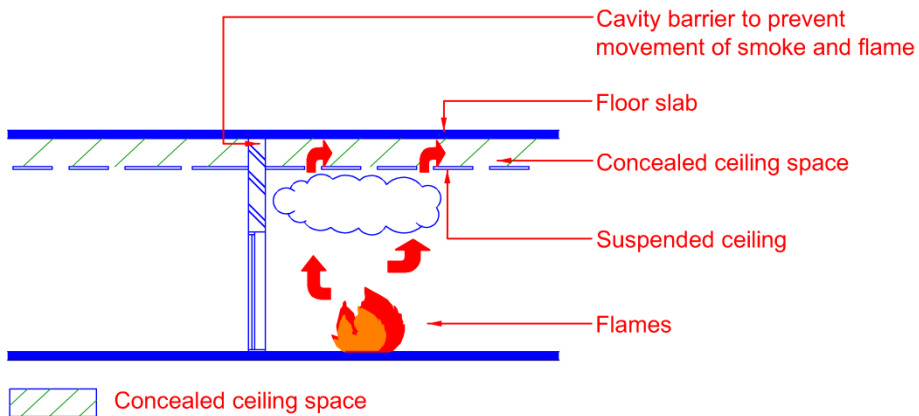

Diagram 3.11.1-2

*Concealed spaces or cavities in building provide a ready route or flue for smoke and flame to spread undetected for quite some time, thus increasing the risk to life safety of occupants in the building. This is particularly so in the case of void spaces above a suspended ceiling or in a roof space or in a raised floor system. Provisions are available in the Fire Code to reduce the risk of concealed smoke and flame spread by the introduction of cavity barrier when the area or linear dimensions of cavities exceed the limits as per Table 3.11A. Cavity barriers shall be constructed of non-combustible materials and shall have at least half hour fire resistance.*

# CHAPTER 3

## 3.11 CONCEALED SPACES

### 3.11.2 Closing the edges of cavities

Cavity barriers shall be used to close the edges of cavities, edges around openings through a wall, floor and any other part of the construction which contains a cavity and to separate any cavity in a wall, floor or any other part of the construction from any other such cavity.

#### EXPLANATIONS & ILLUSTRATIONS

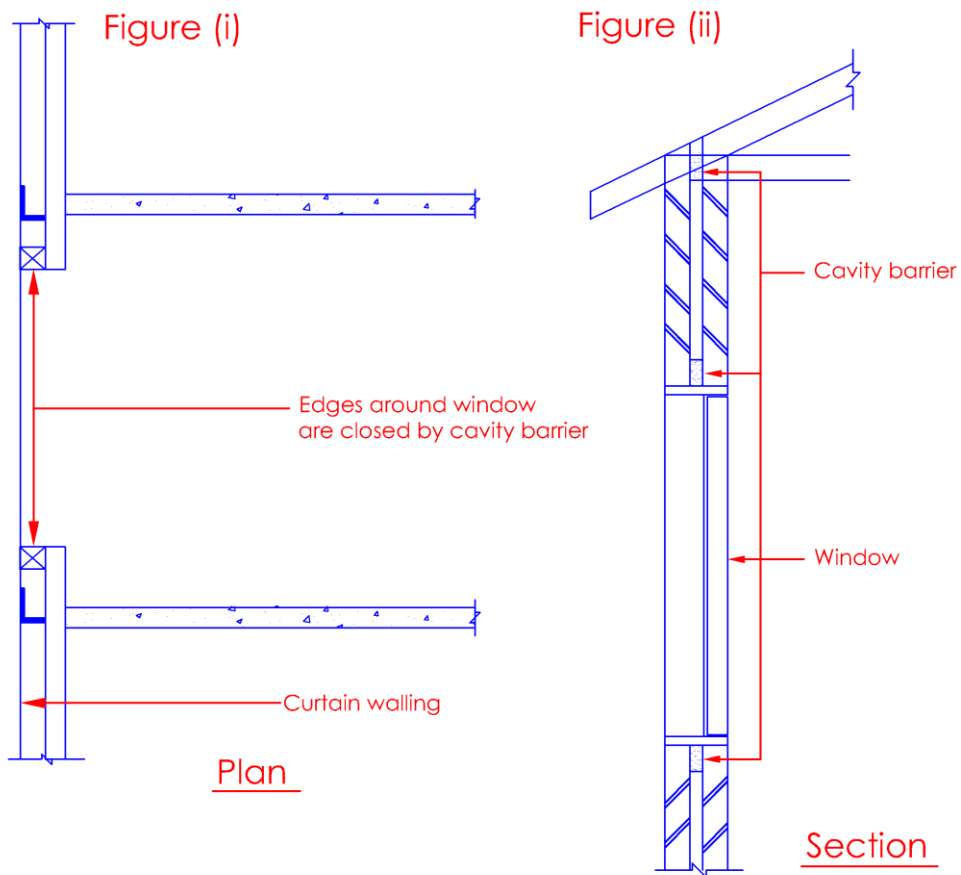

Diagram 3.11.2

“Cavity barrier” means any construction provided to close a cavity against, or restrict the spread of smoke and flame within it.

In figure (I) above, cavity barriers are used to close the edges around the window opening. Similar application is provided to window in external cavity wall in figure (ii).

# CHAPTER 3

## 3.11 CONCEALED SPACES

### 3.11.3 Interrupting cavities

Cavities including roof spaces shall be interrupted by cavity barriers where a wall, floor, ceiling, roof or other part of the construction abut the cavity, if there is provision for the element of structure to form a fire resisting barrier. Such cavity barriers shall be of fire resisting construction at least equal to the provision for that required for the fire resisting barrier.

### EXPLANATIONS & ILLUSTRATIONS

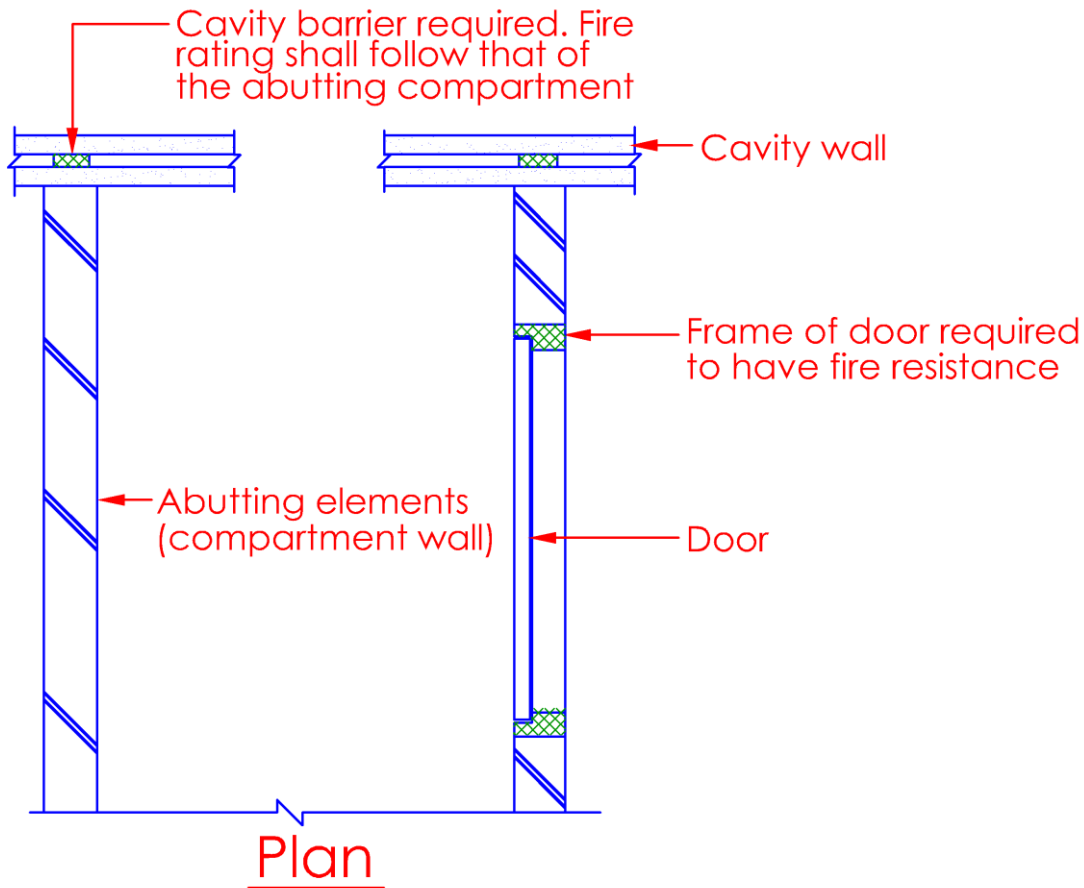

Diagram 3.11.3-(i)

*Cavities must be closed where the fire barrier elements (compartment walls) abut the cavity (including the frame of a door).*



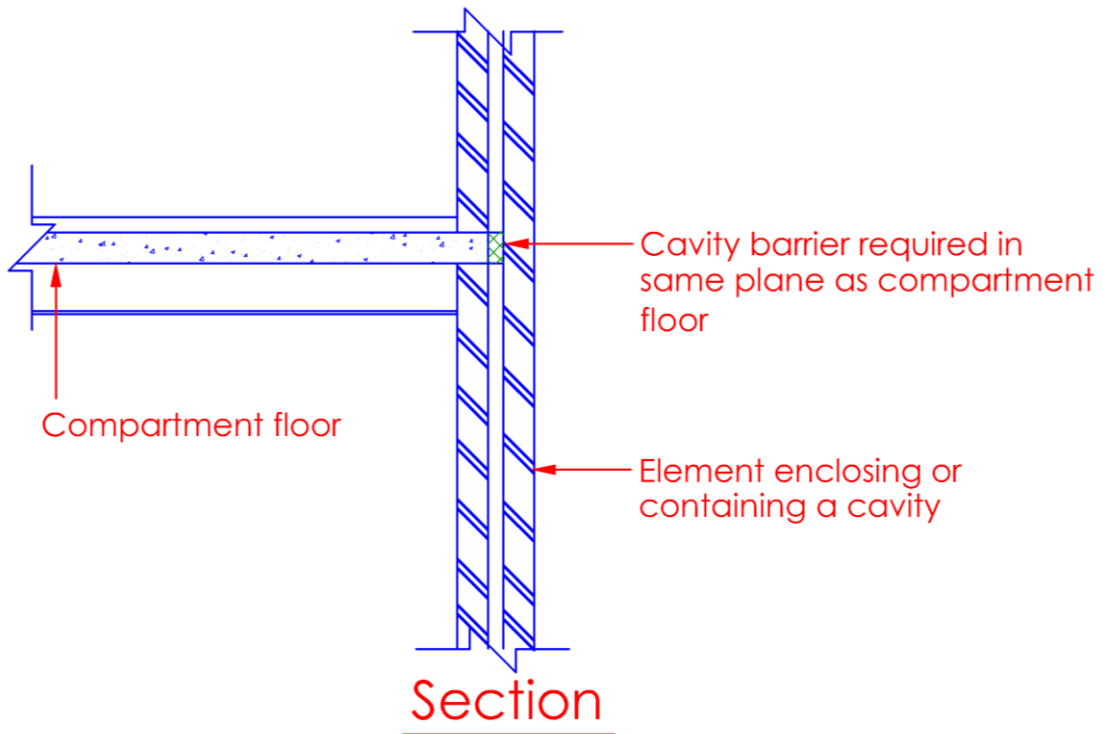

Diagram 3.11.3-(ii)

*Cavity in the walls shall be closed where the compartment floor abuts it.*

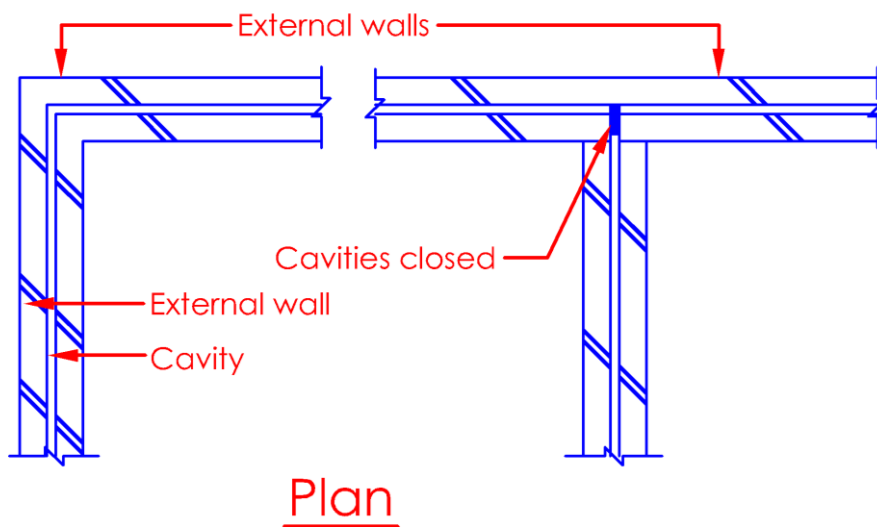

Diagram 3.11.3-(iii)

*Any cavity within an element, or at the junction of two elements, must be closed by a cavity barrier.*

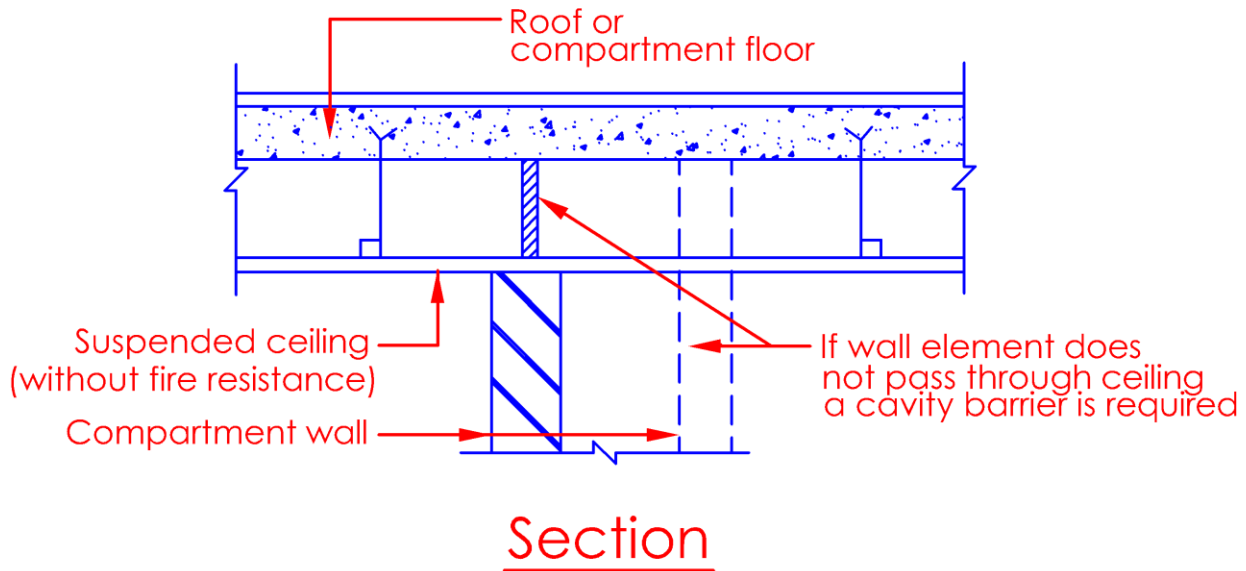

Diagram 3.11.3-(iv)

*It is a common practice to bring the compartment wall right-up to the underside of the structural slab above. The cavity barrier above the compartment wall shall be treated as an extension of the compartment wall below.*

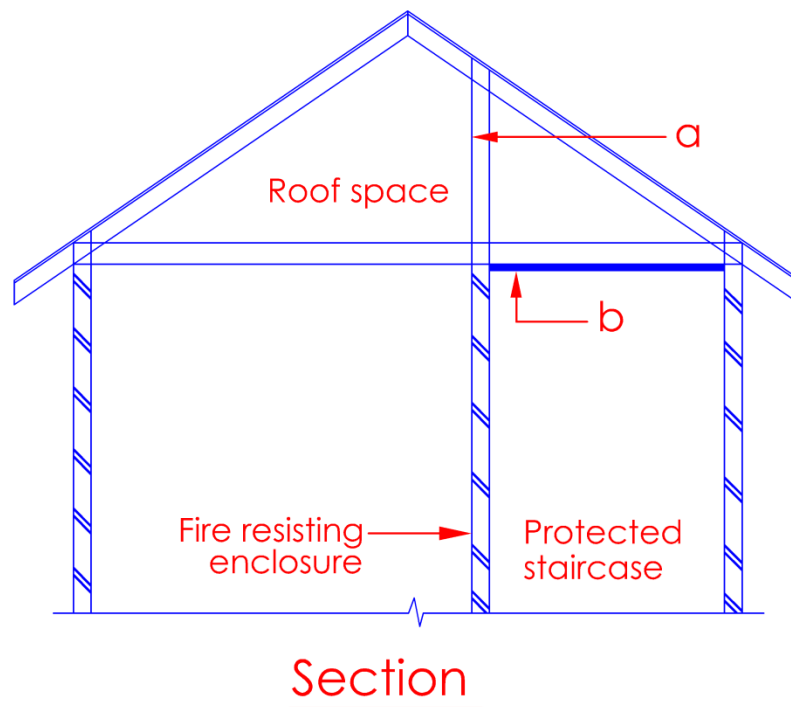

Diagram 3.11.3-(v)

*The roof space over a protected staircase must be separated by either a cavity barrier at (a) having the same fire rating as the wall of the staircase below, or a fire rated ceiling at (b). See Cl.1.2.8 for further illustration. Extending the masonry wall right up to the underside of the roof coverings at (a) would meet the requirement under Cl.3.10 of having masonry enclosure to exit staircase.*

# CHAPTER 3

## 3.11 CONCEALED SPACES

### 3.11.4 Sub-division of extensive cavities

Cavities, including roof spaces, unless otherwise permitted, shall be sub-divided so that the maximum distance between cavity barriers shall not exceed the relevant dimensions given under Table 3.11A.

**TABLE 3.11A MAXIMUM DIMENSIONS OF CAVITIES**

Location of cavity	Purpose Group of building or compartment	*Class of surface exposed in cavity	Max. dimension in any direction
Between roof and ceiling	I & II	any	no limit
	others	any	20m
Any other cavity	any	Class 0	20m
	any	any	8m

\* excluding surface of any pipe, cable, conduit or insulation of any pipe.

### EXPLANATIONS & ILLUSTRATIONS

*The main reason of limiting the dimension of cavities is to prevent fire or smoke from spreading widely in large concealed space.*

*It is unusual to find extensive cavities, including roof spaces for development under Purpose Group II. Based on the above table, ceiling spaces in buildings under Purpose Group II are not required to be provided with cavity barriers, irrespective of the size of the cavity.*

# CHAPTER 3

## 3.11 CONCEALED SPACES

### 3.11.5 Fire resistance and fixing of cavity barriers

Cavity barriers shall be

- (a) Constructed to provide at least half an hour fire resistance, and
- (b) Tightly fitted to rigid construction or the junctions shall be fire stopped to comply with the requirements of Cl.3.12.

### EXPLANATIONS & ILLUSTRATIONS

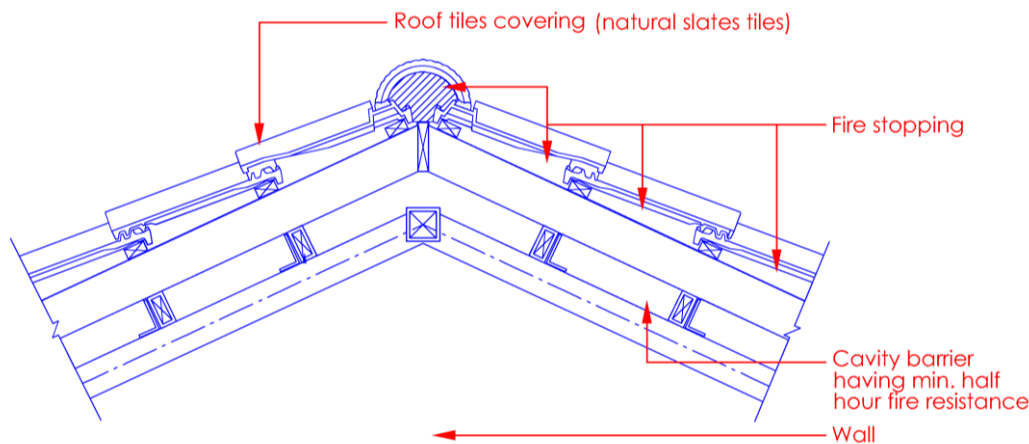

Diagram 3.11.5-1

*Cavity barriers must be tightly fitted to rigid construction and mechanically fixed in position wherever possible. Where this is not possible (for example, in the case of a junction with slates tiles, corrugated sheeting or similar materials) the junction should be fire-stopped to prevent the spread of fire and smoke in the concealed space.*

*Cavity barriers must also be fixed so that performance will not be made ineffective by:*

- (a) *Movement of the building due to subsidence, shrinkage or temperature change; and*
- (b) *collapse in fire of any services penetrating them; and*
- (c) *failure in fire of fixings; and*
- (d) *failure in fire of any material or construction which they may abut. For example, if a suspended ceiling is continued over the top of a fire-resisting wall or partition, and direct connection is made between the ceiling and the cavity barrier above the line of the wall or partition, premature failure of the cavity barrier can occur when the ceiling collapses. However, this does not arise if the ceiling is designed to provide fire protection of 30 minutes or more.*

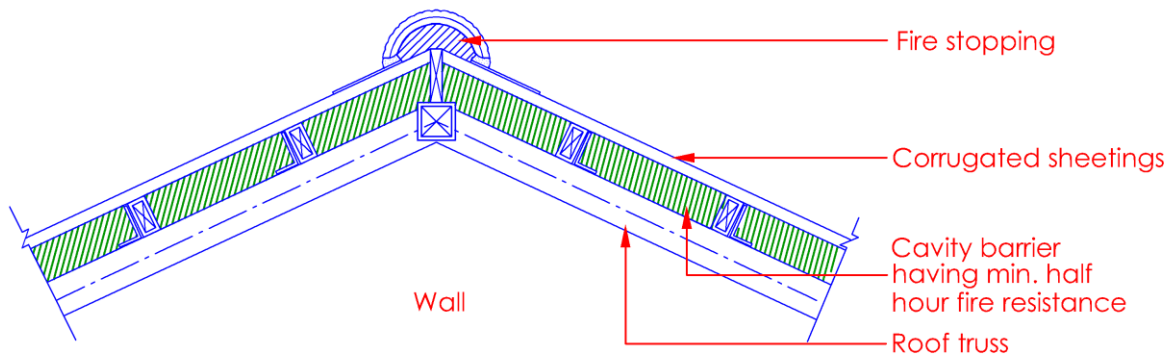

Diagram 3.11.5-2

*The main purposes of extending the compartment walls into the ceiling space are to complete the compartmentation to each apartment unit and to prevent smoke and fire spread via the concealed ceiling space.*

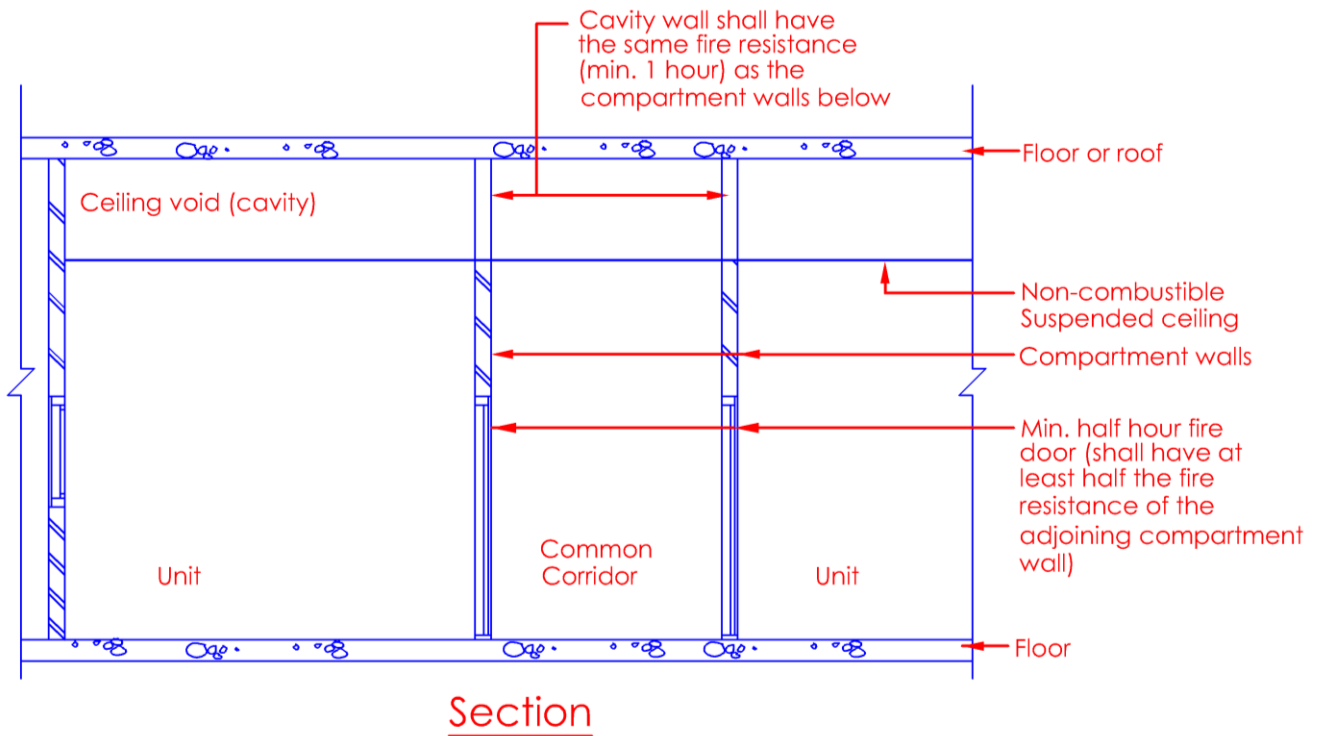

Diagram 3.11.5-3

*Compartment walls should be carried right up to the full storey height, to a compartment floor above or to the roof coverings, as appropriate. The walls in the ceiling above the common corridor shall not be treated as cavity barriers. They shall be treated as extension of the compartment walls below.*

*The main purposes of extending the compartment walls into the ceiling space are to complete the compartmentation to each apartment unit and to prevent smoke and fire spread via the concealed ceiling space.*

# CHAPTER 3

## 3.11 CONCEALED SPACES

### 3.11.6 Openings in cavity barriers

A cavity barrier shall have no opening in it except for:

- (a) A door which has at least half an hour fire resistance and shall be kept closed all the time,
- (b) A pipe which complies with the provision under Cl.3.9.3,
- (c) A cable or conduit containing one or more cables,
- (d) An opening fitted with suitably mounted automatic fire damper, and
- (e) A duct which is fitted with a suitably mounted fire damper where it passes through the cavity barrier.

### EXPLANATIONS & ILLUSTRATIONS

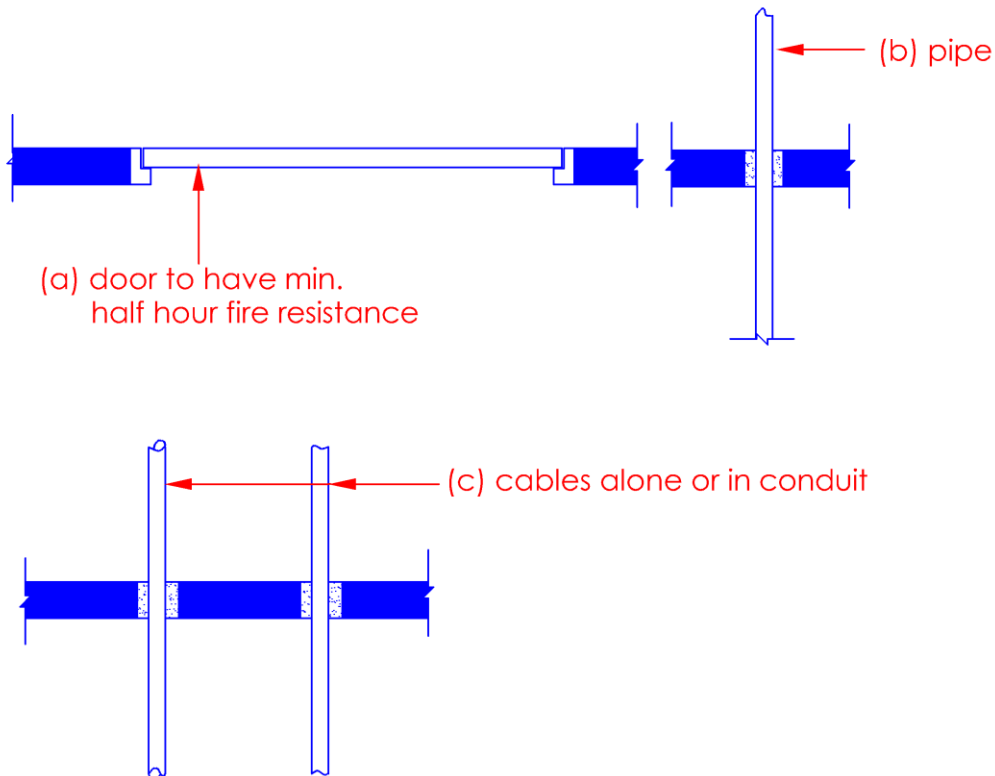

Diagram 3.11.6-1



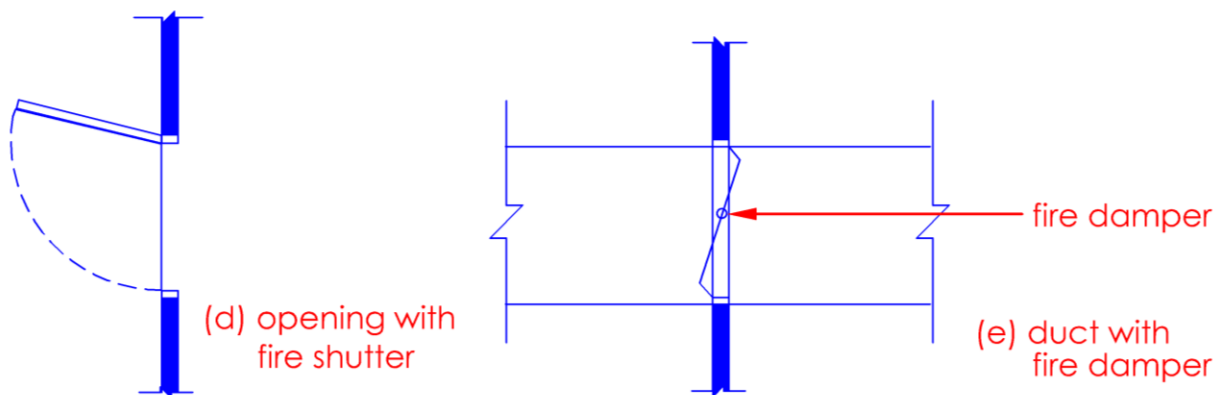

Diagram 3.11.6-2

*Penetrations of cavity barriers shall be restricted to those illustrated above. All openings through cavity barriers must be no larger than necessary and be fire stopped. The fire stopping shall not restrict thermal movement.*

# CHAPTER 3

## 3.11 CONCEALED SPACES

### 3.11.7 Raised floors for fixed stages and display platforms

The construction of raised floors for fixed stages and display platforms shall comply with the following requirements :

- (a) The concealed space between the structural floor and raised floor shall not be used for storage purpose, and
- (b) No services or installation shall be permitted within the concealed space other than electrical wiring in conduit in compliance with the requirements of SS CP 5 Code of Practice for Wiring of Electrical Equipment of Buildings, and
- (c) All sides shall be properly sealed, and
- (d) The concealed space shall be sub-divided by cavity barriers in compliance with the requirements of Cl.3.11.4 and Table 3.11A.

### EXPLANATIONS & ILLUSTRATIONS

*Raised floor with exposed surfaces in cavity having Class '0' flame spread*

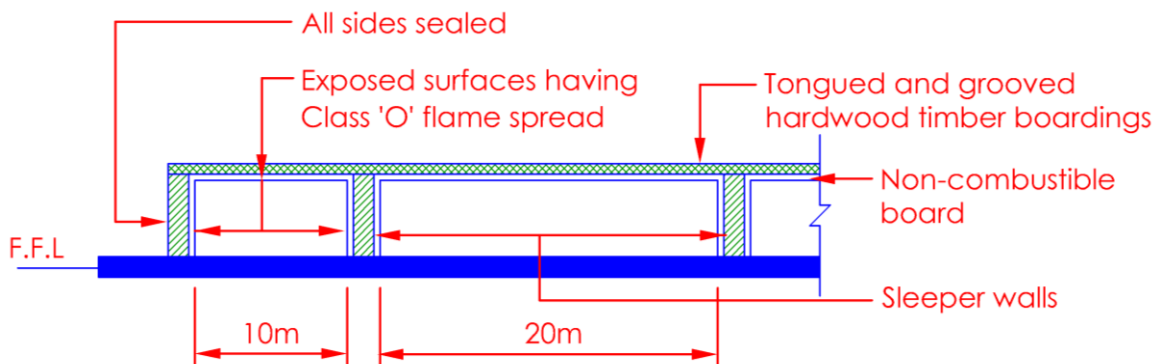

Diagram 3.11.7-1

*The space between the floor and the raised floor or platform shall not be used for storage purpose. Electrical wiring in the space shall be in conduit in accordance with SS CP 5. Under Table 3.11A, cavity barrier is to be provided at 20m dimension in any direction. Sleeper walls, which are provided for support to the floor or platform, act as a cavity barrier in the concealed space.*

*Raised floor with exposed surfaces in cavity having other than Class '0' flame spread*

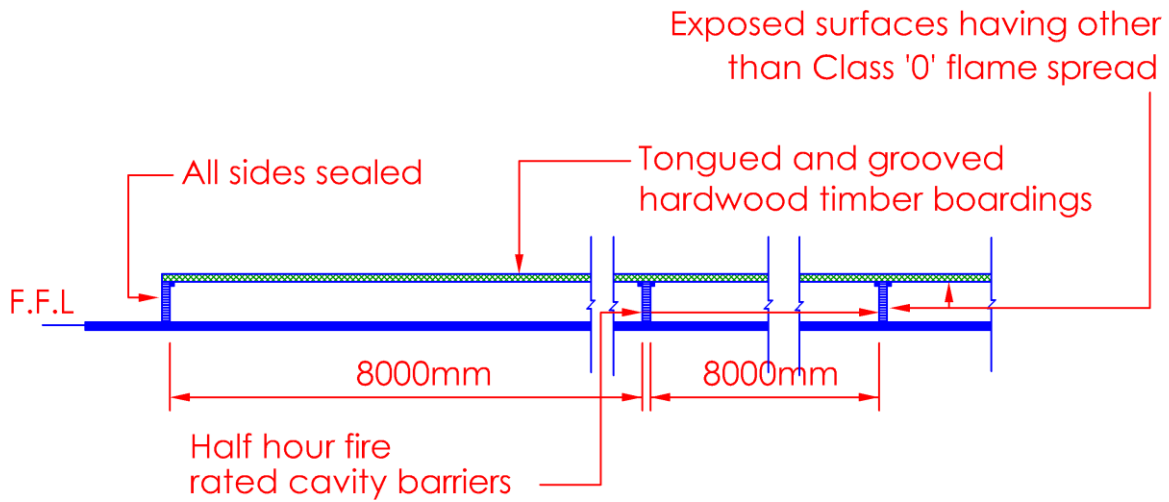

Diagram 3.11.7-2

*The space between the floor and the raised floor or platform shall not be used for storage purpose. Electrical wiring in the concealed space shall be in conduit in accordance with SS CP 5. Under Table 3.11A, cavity barrier is to be provided at 8m dimension in any direction. As such, ½ hour fire rated cavity barriers are provided to sectionalise the concealed space.*

# CHAPTER 3

## 3.11 CONCEALED SPACES

### 3.11.8 Raised floors with or without accessible panels

The construction of raised floors with or without accessible panels shall comply with the following requirements :

- (a) The supporting structure shall be constructed of non-combustible materials having a melting point of at least 800°C, and
- (b) The concealed space between the structural floor and raised floor shall not be used for storage purpose, and
- (c) No services or installation shall be permitted within the concealed space other than
  - (i) electrical wiring in metal conduit and metal trunking in compliance with the requirements of SS CP 5 Code of Practice for Wiring of Electrical Equipment of Buildings;
  - (ii) communication cables for computer equipment
  - (iii) fire protection installations serving the area, and
- (d) Where the raised floor is used as a plenum, requirements in Cl.7.1.1(f) shall be satisfied, and

### EXPLANATIONS & ILLUSTRATIONS

*See clause 7.1.1(f) for illustration*

- (e) Decking of the raised floor shall be constructed of non-combustible material or where combustible material is used as core material, if allowed in the case of sprinkler protected buildings, the top, bottom, all sides and cut edges shall be covered with material with surface property complying with Class 0 (excluding materials for floor finishes), and

**EXPLANATIONS & ILLUSTRATIONS**

**3.11.8(e)**

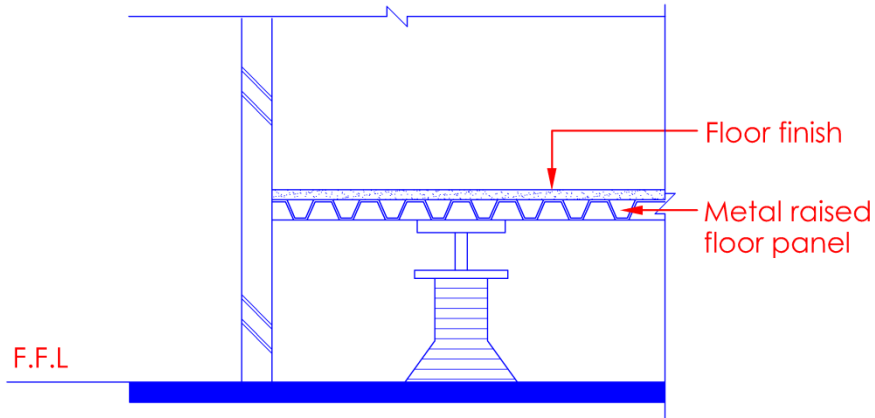

*Diagram 3.11.8(e)-1*

*Non-combustible raised floor panels and supports are allowed to be used in non-sprinkler or sprinkler protected buildings.*

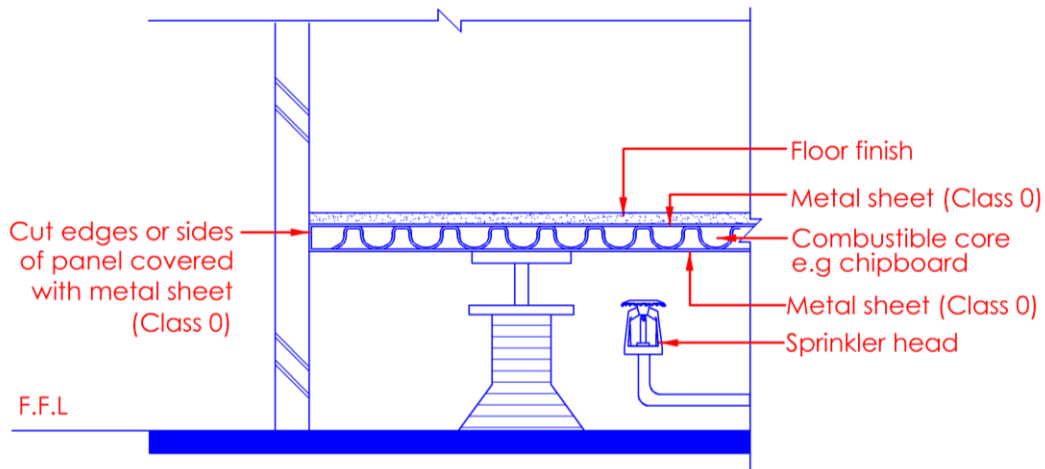

*Diagram 3.11.8(e)-2*

*Raised floor panel constructed of combustible core, eg. chipboard, shall only be allowed to be used in buildings protected by sprinkler system and that the underside of the raised floor is adequately covered by the sprinkler system.*

- (f) In the case of raised floors with accessible panels, access sections or panels shall be provided such that all concealed spaces between the structural floor and raised floor are easily accessible, and
- (g) Openings in the raised floor for entry of electrical cables shall be effectively closed to prevent entry of debris or other combustible material into the concealed spaces, and
- (h) All sides shall be properly sealed, and
- (i) The concealed space shall be sub-divided by cavity barriers such that the maximum unobstructed area within the concealed space does not exceed  $930\text{m}^2$ , and
- (j) Where the concealed space is fitted with an automatic sprinkler system which complies with the requirements in Chapter 6, cavity barriers are not required, and

**EXPLANATIONS & ILLUSTRATIONS**

**3.11.8(g)**

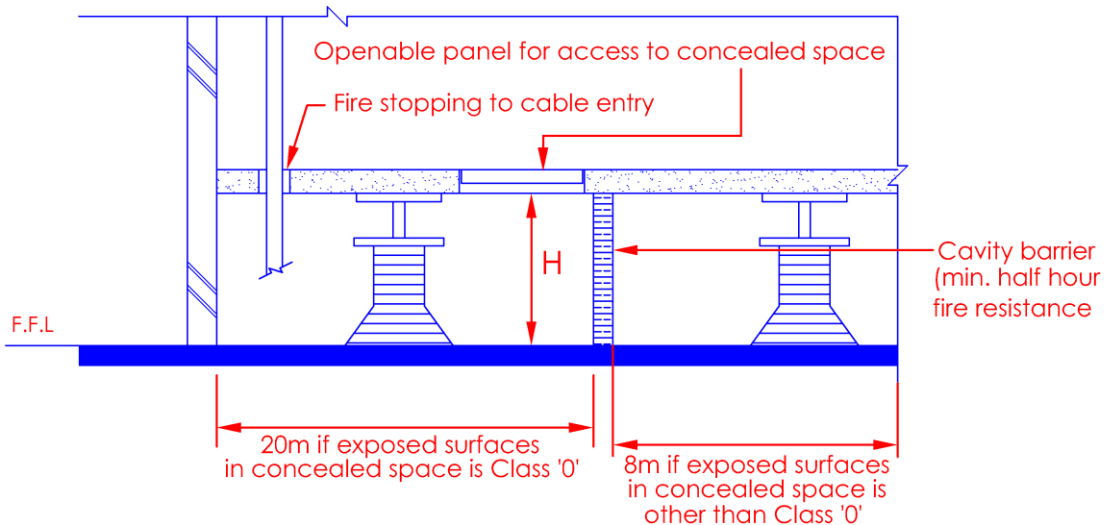

*Diagram 3.11.8(g) – (j)*

*The provision of cavity barriers shall comply with Table 3.11A of the Fire Code.*

Non-sprinkler protected building

*Cavity barriers shall be provided in accordance with Table 3.11A. The height of concealed space (H), measured between the finished floor level and the underside of the raised floor decking shall not exceed 400mm. The concealed space shall be fitted with smoke detection system in accordance with SS CP 10 Code of Practice for the Installation and Servicing of Electrical fire Alarm Systems. SS CP 10 also allows that smoke detector system is not required to be provided in concealed space which does not exceed 150mm in height – Cl.2.1.3.1(b). Automatic smoke detection system is applicable if the height of concealed space exceeds 400mm.*

Sprinkler protected building

*Cavity barriers shall be provided in accordance with Table 3.11A. Where the height of the concealed space does not exceed 400mm, smoke detection system complying with SS CP 10 shall be provided. The height of concealed space may exceed 400mm if the space is fitted throughout with sprinkler system. Where sprinkler system is provided inside the concealed space, cavity barriers are not required to be provided – subclause (j).*

- (k) For a non-sprinklered protected building, if the height of the concealed space measured between the top of the structural floor and underside of the raised floor decking exceeds 150mm, it shall be fitted with automatic smoke detection system complying with requirements of SS CP 10 Code of Practice for the Installation and Servicing of Electrical Fire Alarm Systems. For a sprinkler protected building, the concealed space shall be fitted with automatic smoke detection system as above if its height is between 150mm to 400mm, and automatic sprinkler system if it exceeds 400mm.
- (l) Where the height of concealed space measured between the top of the structural floor and the underside of the raised floor decking is less than 50mm, the requirements on provision of cavity barriers shall not be applicable.

<b>EXPLANATIONS &amp; ILLUSTRATIONS</b>
---

<b>3.11.8</b>
---------------

*No illustration.*



# CHAPTER 3

## 3.11 CONCEALED SPACES

### **3.11.9 Provision for concealed spaces between floor or roof and suspended ceilings**

The Relevant Authority may consent to exempt from provision of cavity barriers within the concealed spaces of suspended ceiling, provided the following requirements are complied with: -

- (a) The concealed space shall not be used for storage purpose, and
- (b) The supporting elements shall be constructed of non-combustible material, and
- (c) The exposed surfaces within the concealed space is of Class 0 flame spread, (excluding surfaces of any pipe, cable, conduit or insulation of any pipe) and
- (d) In the case of a detector protected building, if the concealed space does not exceed 800mm in depth or if the concealed space is fitted with detectors which comply with the requirements of Chapter 6.
- (e) In the case of a sprinkler protected building:
  - (i) if the concealed space does not exceed 400mm in depth, or
  - (ii) if the concealed space exceeds 400mm and does not exceed 800mm in depth and no combustible material is used within the concealed space, (where the combustible content is small in quantity, the Relevant Authority, may, at its discretion, rule that such combustible content may be irrelevant in relation to this sub-clause), or
  - (iii) if the concealed space is fitted with an automatic sprinkler system which complies with the requirements of Chapter 6.
- (f) In the case of other buildings, if the concealed space does not exceed 800mm in depth.

Detector protected building (Non-sprinkler)

Diagram 3.11.9(d)

Provision of cavity barriers in concealed ceiling space may not be required if the following requirements are complied with :

- the space is not used for storage purpose; and
- the supporting elements eg. ceiling hangers or supports are constructed of non-combustible material; and
- the exposed surfaces within the concealed space is of Class 0 flame spread (excluding surfaces of any pipe, cable, conduit or insulation of any pipe or duct); and
- concealed space does not exceed 800mm in depth; if exceeds 800mm, it shall be fitted with smoke or heat detectors.

*Sprinkler protected building - Depth of ceiling space does not exceed 400mm*

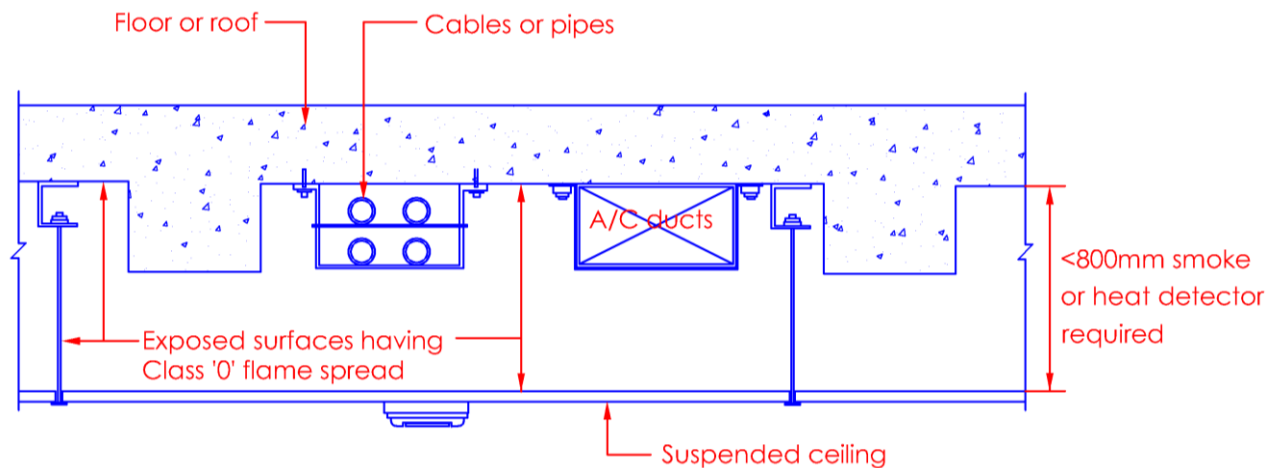
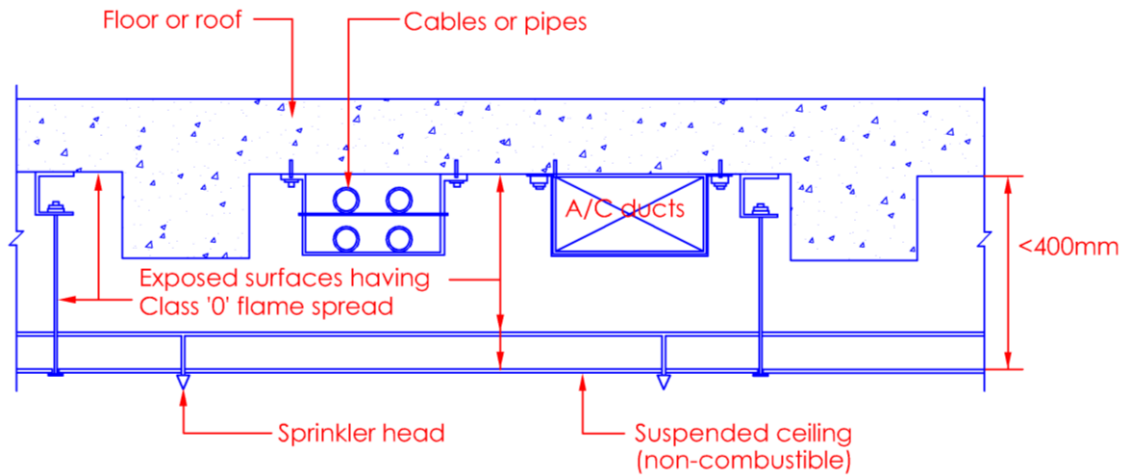

Diagram 3.11.9(e)(i)

*Provision of cavity barriers in the concealed ceiling space may not required if the following are complied with :*

- a) *the space is not used for storage purpose; and*
- b) *the supporting elements eg. ceiling hangers or supports are constructed of non-combustible material; and*
- c) *the exposed surfaces within the concealed space is of Class 0 flame spread (excluding surfaces of any pipe, cable, conduit or insulation of any pipe or duct); and*
- d) *concealed space does not exceed 400mm in depth.*

*Sprinkler protected building - Depth of ceiling space exceeds 400mm but not exceeding 800mm*

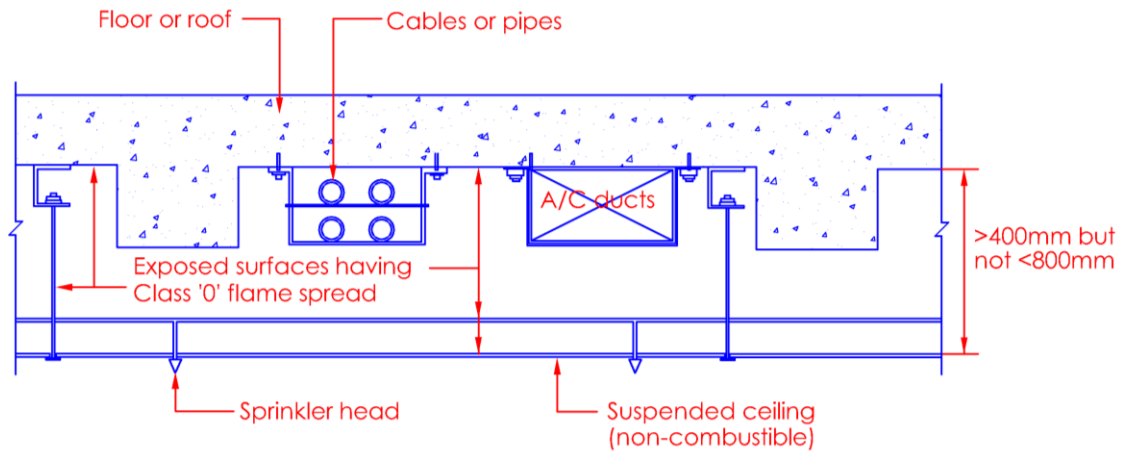

Diagram 3.11.9(e)(ii)

*Provision of cavity barriers in the concealed ceiling space may not required if the following are complied with :*

- a) *the space is not used for storage purpose; and*
- b) *the supporting elements eg. ceiling hangers or supports are constructed of non- combustible material; and*
- c) *the exposed surfaces within the concealed space is of Class 0 flame spread(excluding surfaces of any pipe, cable, conduit or insulation of any pipe or duct); and*
- d) *no combustible material is used within the concealed space. However, where the combustible content is small in quantity, FSSD may, at its discretion grants exemption, provided the space is protected by sprinklers installed on the extended basis under sub-clause 6.6.1.2 of SS CP 52. (whole coverage to be extended to the ceiling)*

Concealed space is sprinklered protected – in accordance with Chapter 6

Diagram 3.11.9(e)(iii)

Provision of cavity barriers in the concealed ceiling is not required. See also cl.3.11.10 for further relaxation.

Other building – which neither requires detector nor sprinkler system

Diagram 3.11.9(f)

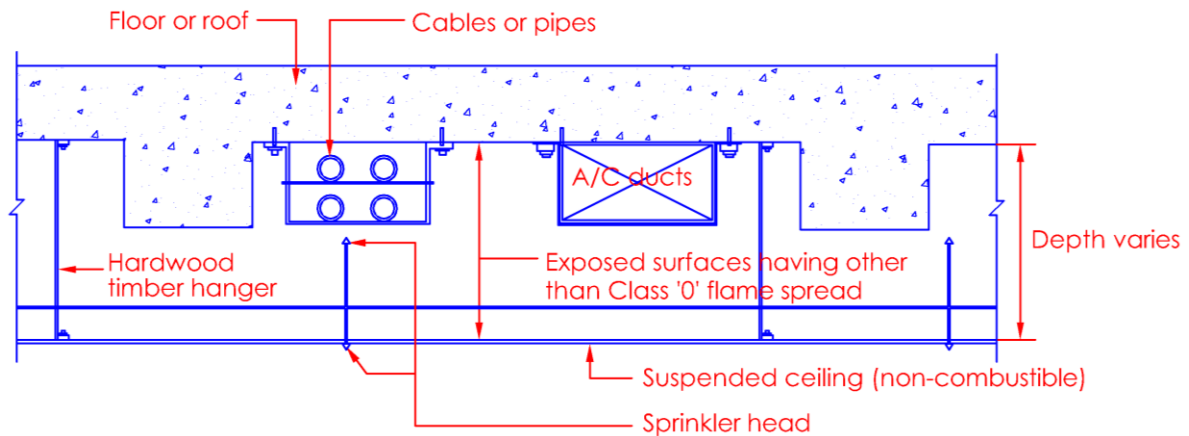
Provision of cavity barriers in the concealed ceiling space may not be required if the following are complied with :

- (a) the space is not used for storage purpose; and
- (b) the supporting elements eg. ceiling hangers or supports are constructed of non-combustible material; and
- (c) the exposed surfaces within the concealed space is of Class 0 flame spread (excluding surfaces of any pipe, cable, conduit or insulation of any pipe or duct); and
- (d) concealed space does not exceed 800mm in depth; if exceeds 800mm, it shall be fitted with smoke or heat detectors.

# CHAPTER 3

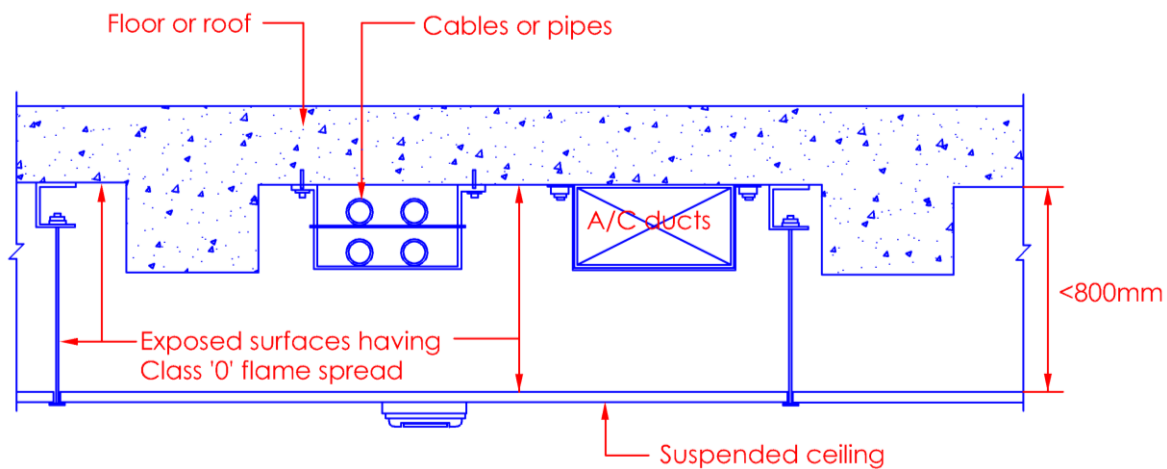
## 3.11 CONCEALED SPACES

### 3.11.10 Exemption of cavity barriers in ceiling space

Where the concealed space of suspended ceiling is fitted with an automatic sprinkler system which complies with the requirements in Chapter 6,

- (a) The concealed space may be exempted from provision of cavity barriers, and
- (b) Combustible materials and materials with other than Class 0 flame spread may be used for the supporting elements and exposed surfaces of materials within the concealed space, provided the ceiling is not situated over an exit passageway, smoke-stop lobby or other designated means of escape facilities.

### EXPLANATIONS & ILLUSTRATIONS

*No illustration.*

- i) Where the concealed ceiling space is protected by automatic sprinkler system, the above clause allows the following :*
  - a) Provision of cavity barrier is exempted;*
  - b) Combustible materials such as hardwood timber hangers for ceiling; and*
  - c) Exposed surfaces within the ceiling space may be of any class other than Class 0 flame spread ie. timber members.*
- ii) The above relaxation shall not apply if the above ceiling construction is situated over an exit passageway, smoke-stop lobby or other designated means of escape facilities.*

# CHAPTER 3

## 3.11 CONCEALED SPACES

### 3.11.11 Suspended ceiling over protected areas

The concealed spaces of suspended ceiling over an exit passageway, smoke-stop lobby, exit staircase or other designated means of escape facilities, shall comply with the following:

- (a) the ceiling supporting elements and the ceiling shall be constructed of non-combustible materials; and
- (b) the exposed surfaces within the concealed space shall be of Class 0 surface flame spread.

### EXPLANATIONS & ILLUSTRATIONS

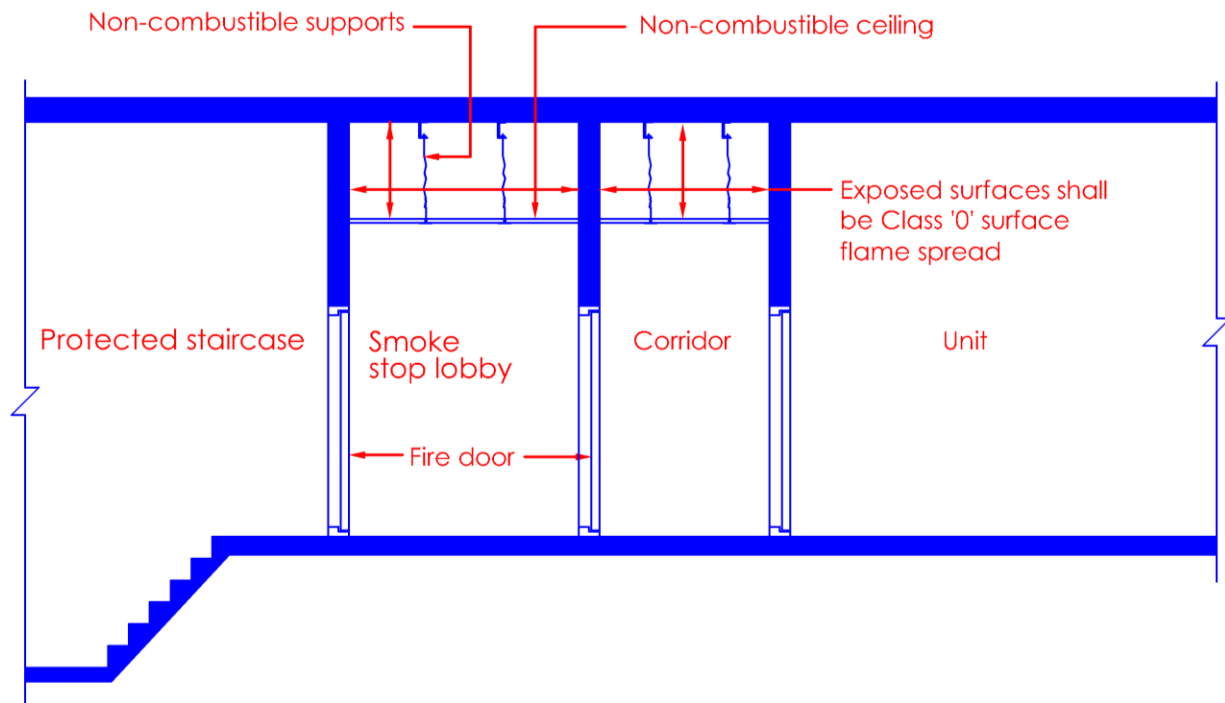

Diagram 3.11.11

*The main concern is that spaces meant for safe escape of occupants shall be kept free of combustible materials. Common corridors are treated as escape routes. The exposed surfaces within ceiling space shall have a flame spread rating of Class '0'.*

- (c) Where sprinkler system is installed within the concealed spaces at smoke-stop lobby/fire-fighting lobby, the ceiling supporting elements and its exposed surface may have a surface spread of flame not lower than Class 2.

**EXPLANATIONS & ILLUSTRATIONS**

**3.11.11**

*No illustration.*



# CHAPTER 3

## 3.11 CONCEALED SPACES

<b>3.11.12</b>	
Buildings under Purpose Group I are not required to comply with the requirements on the provision of cavity barrier in concealed spaces. Residential units in buildings under Purpose Group II need not comply with requirements on the provision of cavity barrier in concealed floor and ceiling spaces.	

<b>EXPLANATIONS &amp; ILLUSTRATIONS</b>	
---	--

*No illustration.*

# CHAPTER 3

## 3.12 FIRE STOPPING

### 3.12.1 General provision

Openings for pipes, ducts, conduits or cables which pass through any part of an Element of Structure (except for a part which does not serve as a fire resisting barrier) or Cavity Barrier, shall be :

- (a) Kept as few in number as possible, and
- (b) Kept as small as practicable, and
- (c) All gaps shall be filled with fire-stopping materials.

### EXPLANATIONS & ILLUSTRATIONS

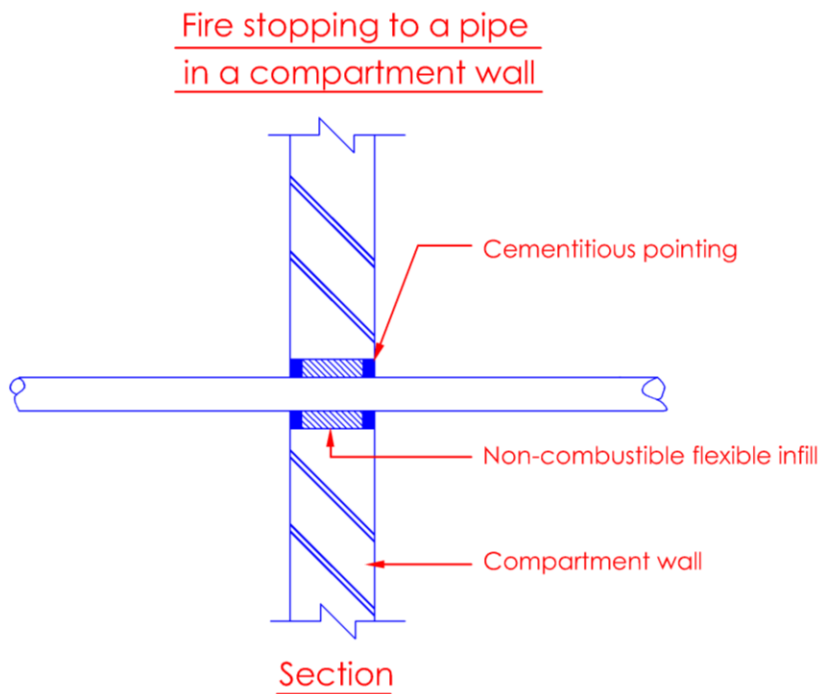

Diagram 3.12.1

*Fire stopping is concerned with ensuring that the fire-resisting capability of a component ,i.e separating wall, compartment wall/floor, cavity barrier is not diminished or impaired when penetrated by services for example, a pipe, ducts etc.*

*Therefore whenever gaps are created by the penetration of such pipes, ducts in the fire rated wall/floor, they must be kept as few as possible. The spacing and internal diameter of pipes passing through any elements of structure or cavity barrier shall comply with Cl.3.9.3 and Table 3.9A.*

# CHAPTER 3

## 3.12 FIRE STOPPING

<b>3.12.2 Fire stopping</b>	
Fire-stopping shall be of material having the necessary fire resistance when tested to BS 476: Part 20 or other acceptable standards.	

<b>EXPLANATIONS &amp; ILLUSTRATIONS</b>	
---	--

*No illustration.*

# CHAPTER 3

## 3.12 FIRE STOPPING

### 3.12.3 Materials for fire- stopping

Suitable fire-stopping materials include :

- (a) Proprietary fire stopping and sealing systems (including those designed for service penetrations) which have been shown by test to maintain the fire resistance of the wall or other element, subject to approval by the Relevant Authority.
- (b) Other fire-stopping materials include:
  - (i) cement mortar;
  - (ii) gypsum based plaster;
  - (iii) cement or gypsum based vermiculite/perlite mixes;
  - (iv) glass fibre, crushed rock, blast furnace slag or ceramic based products (with or without resin binders), and
  - (v) intumescent mastics.

The method of fire stopping and choice of materials should be appropriate to the situation and its application.

### EXPLANATIONS & ILLUSTRATIONS

*No illustration.*

*To prevent displacement, materials used for fire-stopping should be reinforced with (or supported by) materials of limited combustibility in the following circumstances:*

- (i) *in all cases where the unsupported span is greater than 100mm, and*
- (ii) *in any other cases where non-rigid materials are used (unless they have been shown to be satisfactory by test)*

*Preference should be given to proprietary fire-stopping and sealing system.*

*When cement mortar or gypsum board plaster or cement or gypsum based vermiculite/perlite mixes is used as fire stopping material, care should be exercised to ensure that workmen properly fill up the entire gaps with the appropriate fire stopping material instead of carrying cosmetic application by just filling up the gaps superficially.*

# CHAPTER 3

## 3.13 RESTRICTION OF SPREAD OF FLAME OVER SURFACES OF WALLS AND CEILINGS

### 3.13.1 Requirements for Class 0

Any reference to a surface being Class 0 shall be construed as a requirement that –

- (a) The material of which the wall or ceiling is constructed shall be non-combustible throughout; or
- (b) Requirements for a class other than Class 0 classification

The surface material (or, if it is bonded throughout to a substrate, the surface material in conjunction with the substrate) shall have a surface of Class 1 and if tested in accordance with BS 476: Part 6 shall have an index of performance (I) not exceeding 12 and a sub-index (i) not exceeding 6.

### EXPLANATIONS & ILLUSTRATIONS

*No illustration.*

*BS 476:Part 6 refers to a standard fire test for propagation of products.*

*Under this test, there is a means of comparing the contribution of combustible building materials to the growth of a fire by providing a measure of the rate of heat evolution of the samples, exposed in a small combustion chamber.*

*The performance of each sample is expressed as a numerical index from 0 to 100 or more. Low values of the indexes indicate a low rate of heat release. Three to five specimens are tested.*

*Index of performance  $I = I_1 + i_2 + i_3$  where sub-index  $i_1$  is derived from the first three minutes of test,  $i_2$  from the following seven minutes, and  $i_3$  from the final ten minutes. A high index  $i_1$  indicates an initial rapid ignition and heat release.*

# CHAPTER 3

## 3.13 RESTRICTION OF SPREAD OF FLAME OVER SURFACES OF WALLS AND CEILINGS

### 3.13.2

Any reference to a surface being of a class other than Class 0 shall be construed as a requirement that the material which the wall or ceiling is constructed shall comply with the relevant test criteria as to surface spread of flame specified in relation to that class in BS 476: Part 7.

### EXPLANATIONS & ILLUSTRATIONS

*No illustration.*

*Test under BS 476: Part 7 refers to a standard fire test for the classification of the surface spread of flame of products.*

*This test is able to determine the tendency of surfaces of flat materials to support the spread of flame across their surfaces and specifies a method of classification appropriate to wall and ceiling linings. Class 1 represents the best performance, followed in descending order by Class 2, Class 3 and Class 4.*

# CHAPTER 3

## 3.13 RESTRICTION OF SPREAD OF FLAME OVER SURFACES OF WALLS AND CEILINGS

### 3.13.3

Class 0 shall be regarded as the highest class followed in descending order by Class 1, Class 2, Class 3 and Class 4, as set hereunder:

- \* Class 0 - Surface of no Flame Spread. Those surfaces that conform to the requirements of Cl. 3.13.1.
- \* Class 1 - Surface of Very Low Flame Spread. Those surfaces on which not more than 150mm mean spread of flames occurs under the relevant test conditions.
- \* Class 2 - Surface of Low Flame Spread. Those surfaces on which during the first 1<sup>1/2</sup> minutes of test, the mean spread of flame is not more than 375 mm and the final spread does not exceed 450mm under the relevant test conditions.
- \* Class 3 - Surface of Medium Flame Spread. Those surfaces on which during the first 1<sup>1/2</sup> minutes of test, the mean spread of flame is not more than 375 mm and during the first 10 minutes of test is not more than 825mm under the relevant test conditions.
- \* Class 4 - Surface of Rapid Flame Spread. Those surfaces on which during the first 1<sup>1/2</sup> minutes of test the mean spread of flame is more than 375mm and during the first 10 minutes of test is more than 825mm under the relevant conditions.

### EXPLANATIONS & ILLUSTRATIONS

*No illustration.*

*The reason for having Class 0 is that Class 1 covered too wide a range of performance for use in critical areas. Where a higher degree of protection is required, for example in smoke-stop lobbies, exit staircases, exit passageways (which constitute the escape route), Class 0 is specified.*

# CHAPTER 3

## 3.13 RESTRICTION OF SPREAD OF FLAME OVER SURFACES OF WALLS AND CEILINGS

### 3.13.4 Class of flame spread to be not lower than specified

The surface of a wall or ceiling in a room/space shall be of a class not lower than specified as relevant in the Table 3.13A, provided that -

- (a) Where an automatic sprinkler system is fitted throughout in the building in compliance with the requirements in Chapter 6, there is no control on the surface of flame rating in room / space, except for the following occupancies / usage:
  - (i) Health care facilities, including hospital, nursing home for handicapped, disabled, aged or persons with mental and / or mobility impairments.
  - (ii) Detention facilities.
  - (iii) Exit staircase, exit passageway and smoke-stop / fire fighting lobbies.
- (b) Where a building is not protected by automatic sprinkler system, surfaces of the walls and ceilings may be of a surface class not lower than class 3 to the extent permitted by Cl.3.13.5 (a) and Cl.3.13.5 (b) respectively.
- (c) If timber is used as the surface material for the walls along the side gangways of the auditorium which is not sprinkler protected, the requirements of this regulation pertaining to the requisite class of flame spread may be relaxed only in respect of those parts of such wall surfaces provided the aggregate area of such parts does not exceed 50 percent of the whole surface area of the side walls of the auditorium.



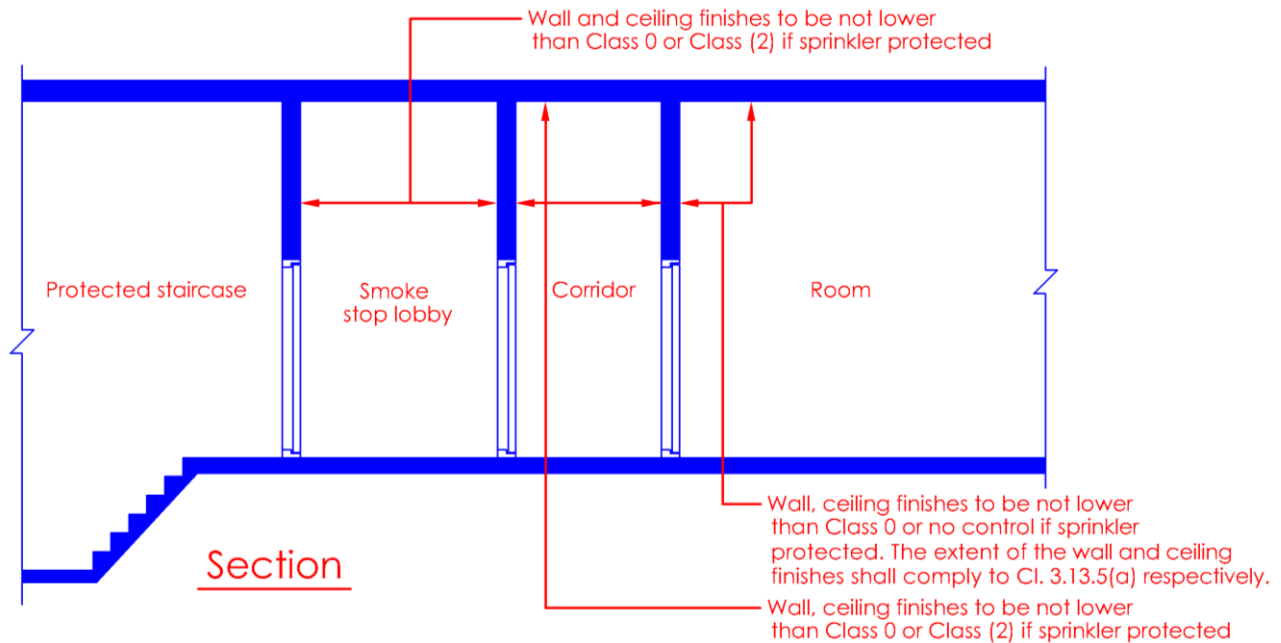

Diagram 3.13.4

Wall, ceiling and floor finishes to exit staircase (including exit passageway) shall be of non-combustible materials or Class 0 (sprinkler protected). For rooms, the extent of wall and ceiling finishes shall comply to Cl.3.13.5 (a) and (b) respectively.

Where a building is protected by automatic sprinkler system, the surfaces of the walls and ceilings of the circulation space (corridor) and institutional occupancy area can be downgraded by 2 classes subject to Class 3 being the lowest.

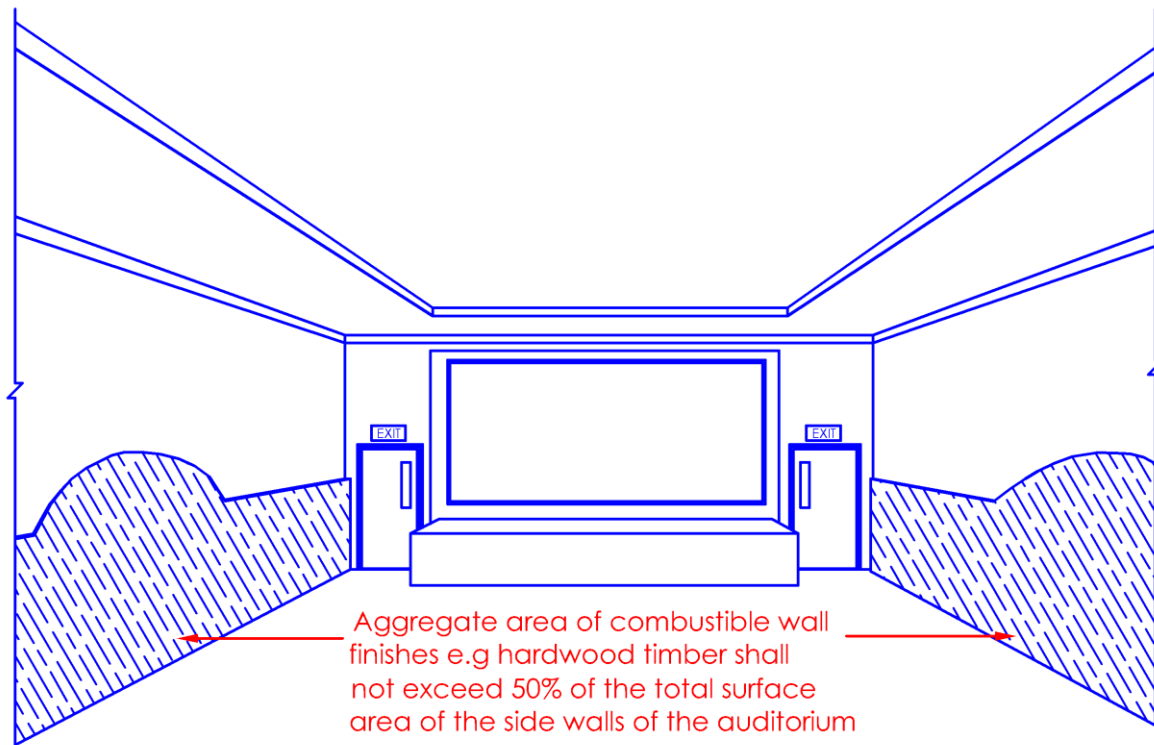

Diagram 3.13.4(d)

*In the design of the auditorium, there is a need to meet the acoustic requirements. Timber was then considered as a preferred material for use. The above clause provides the relaxation for the use of timber as wall linings, provided the aggregate area of the timber linings does not exceed 50% of the whole surface area of the side walls of the auditorium. The other reason for the above relaxation is that each auditorium is required to be constructed as a fire compartment.*

# CHAPTER 3

## 3.13 RESTRICTION OF SPREAD OF FLAME OVER SURFACES OF WALLS AND CEILINGS

### 3.13.5 Where class of flame spread may be of any class not lower than Class 3

- (a) Any part of the surface of a wall in a room or compartment may be of any class not lower than Class 3 if the area of that part (or if there are two or more such parts, the total area of those parts) does not exceed the following –
- (i) in the case of a building or compartment of Purpose Group III, 20m<sup>2</sup>, or
  - (ii) in any other case, 60m<sup>2</sup>.

### EXPLANATIONS & ILLUSTRATIONS

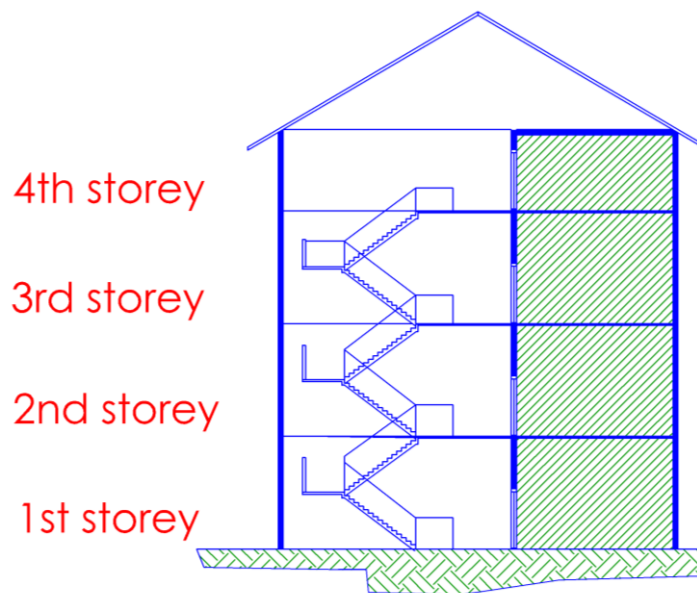

 Class 3 linings to walls of bedroom may have a total area <20sq.m

Diagram 3.13.5(a)

*The linings to internal surfaces of a wall in a room or compartment are permitted to have any Class as permitted under Table 3.13A*

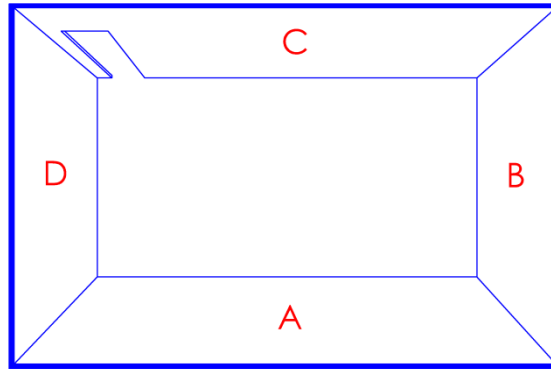

Planal/Isometric view

Diagram 3.13.5(a)(ii)-1

Computation of  $60\text{m}^2$  will be based on total surface areas of walls in a room having not lower than Class 3. In the above diagram, the total surface area of the 4 walls, if finished with Class 3 materials shall not exceed  $60\text{m}^2$ .

Fig. (I)

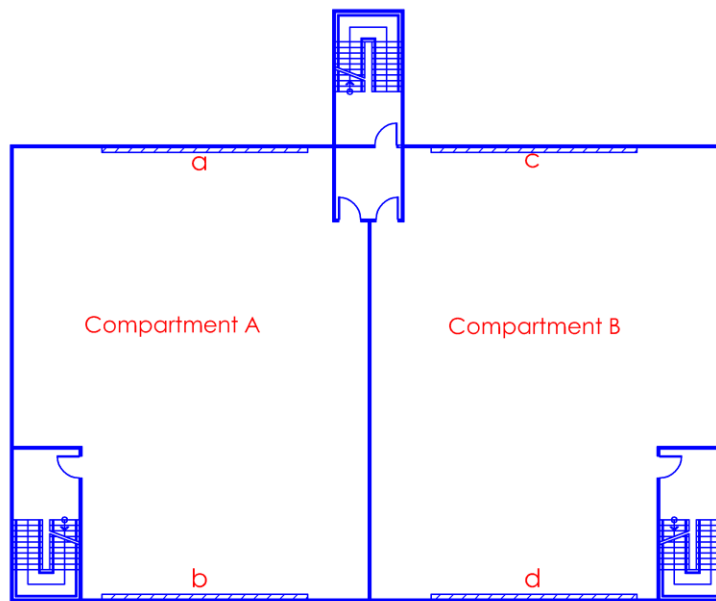

$a + b = \text{max. } 60\text{sq.m}$   
 $c + d = \text{as above}$

Diagram 3.13.5(a)(ii)-2

In the above diagram there are two compartments. Each compartment can have a total of  $60\text{m}^2$  of combustible wall finishes of not lower than class 3. Subsequently, if the compartment wall is removed, there is a need to review the provision of wall finishes, subject to the total wall finishes to the whole floor shall not exceed  $60\text{m}^2$ . Area of wall finishes in excess of  $60\text{m}^2$  is required to be removed.

Fig. (II)

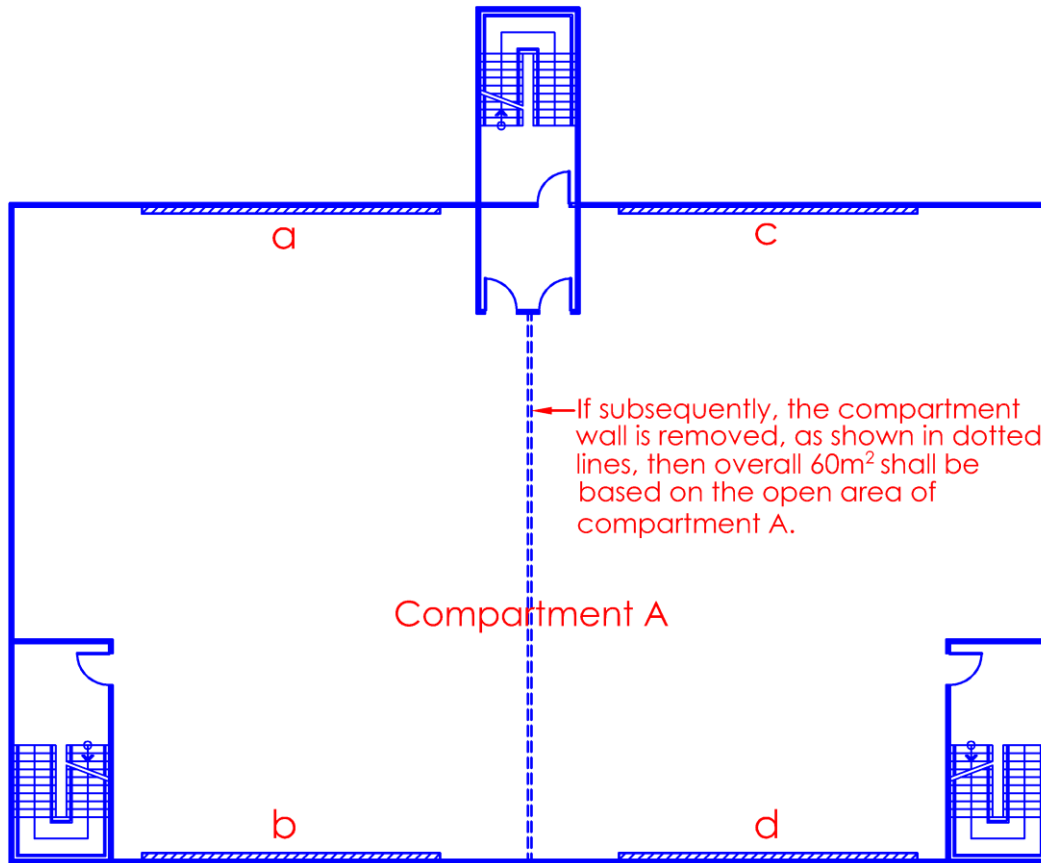

$$a + b + c + d = \text{max. } 60\text{sq.m}$$

Diagram 3.13.5(a)(ii)-3

In the above diagram, if subsequently the compartment wall as shown in dotted lines is removed, the overall 60m<sup>2</sup> shall be based on total floor area of compartment A.

Fig. (III)

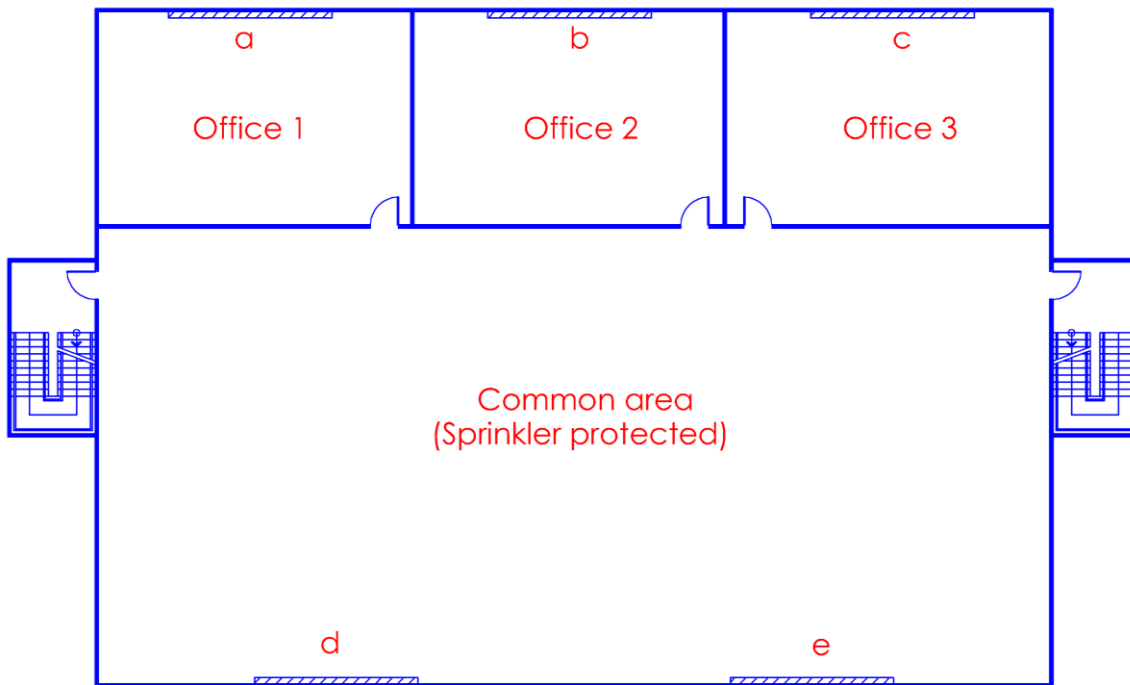

$$a + b + c + d + e = \text{max. } 60\text{sq.m}$$

 Wall finishes not lower than Class 3

Diagram 3.13.5(a)(ii)-4

*In situation where multiple floors are interconnected to form one compartment by atrium design, waiver application is required to vary the max. 60sq.m*

*For Class 3 wall finishes, the total area of 60sq.m excludes :*

- (i) door frames and unglazed parts of doors;
- (ii) window frames and frames in which glazing is fitted;
- (iii) architraves cover moulds, picture rails, skirtings and similar narrow members; and
- (iv) fitted furniture.

- (b) Any part of the surface of a ceiling may be of any class not lower than Class 3 if that part of the surface is the face of a layer of material the other face of which is exposed to the external air (skylight included) and –
- (i) \* the ceiling is that of a room in a building or compartment of Purpose Group III, IV, V or VII or that of a circulation space excluding smoke-stop lobby, exit staircase and exit passageway in a building or compartment of any purpose group, and
    - \* the area of that part does not exceed 2.5m<sup>2</sup>, and
    - \* the distance between that part and any other such part is not less than 3.5m, or
  - (ii) \* the ceiling is that of a room in a building or compartment of Purpose Group VI or VIII, and
    - \* the area of that part does not exceed 5.0m<sup>2</sup>, and
    - \* the distance between that part and any other such part is not less than 1.8m, and
  - (iii) that part and all other such parts are evenly distributed over the whole area of the ceiling and together have an area which does not exceed 20% of the floor area of the room, or
  - (iv) the ceiling is that of a balcony, verandah, open carport, covered way or loading bay which (irrespective of its floor area) has at least one of its longer sides wholly and permanently open, or
  - (v) the ceiling is that of a garage or outbuilding which (irrespective of whether it forms part of a building or is a building which is attached to another building or wholly detached ) has floor area not exceeding 40m<sup>2</sup>.

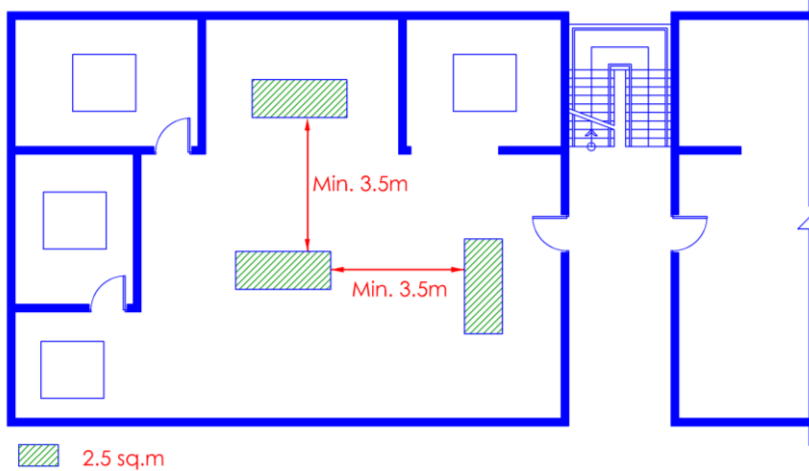

Reflected ceiling plan

Diagram 3.13.5(b)(i)-1

*Ceilings of living room, dining room, kitchen and bedrooms are permitted to have combustible finishes of class not lower than Class 3. The control is based on the size and spacing of the ceiling material.*

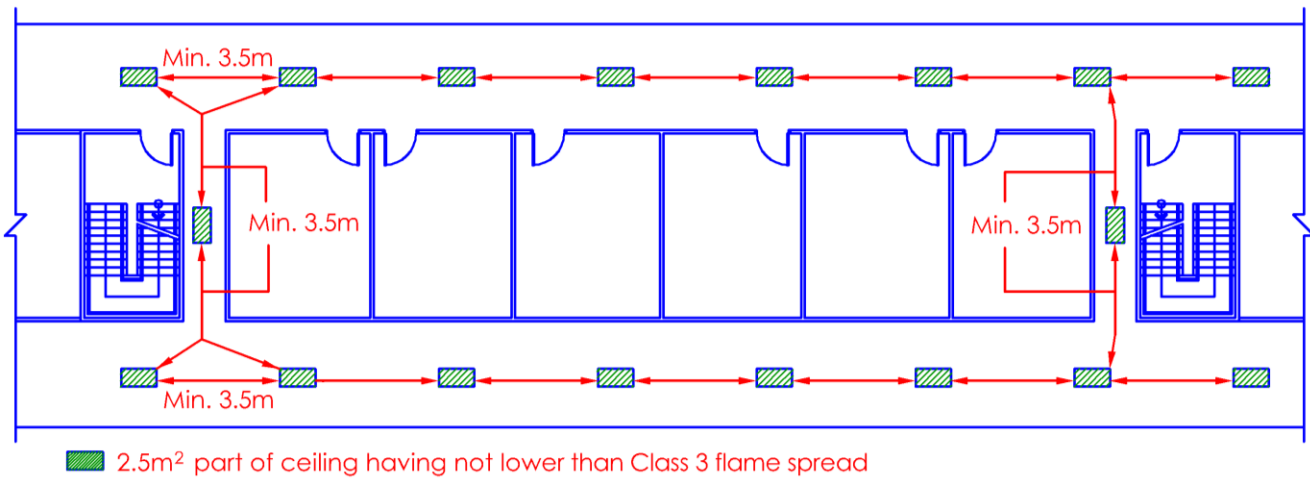

Reflected ceiling plan

Diagram 3.13.5(b)(i)-2

*The above clause is intended for lighting diffuser Any part of a ceiling to circulation space eg. corridor may have not lower than class 3 flame spread, provided each part shall not exceed 2.5m<sup>2</sup> and is separated from other such part by minimum 3.5m.*



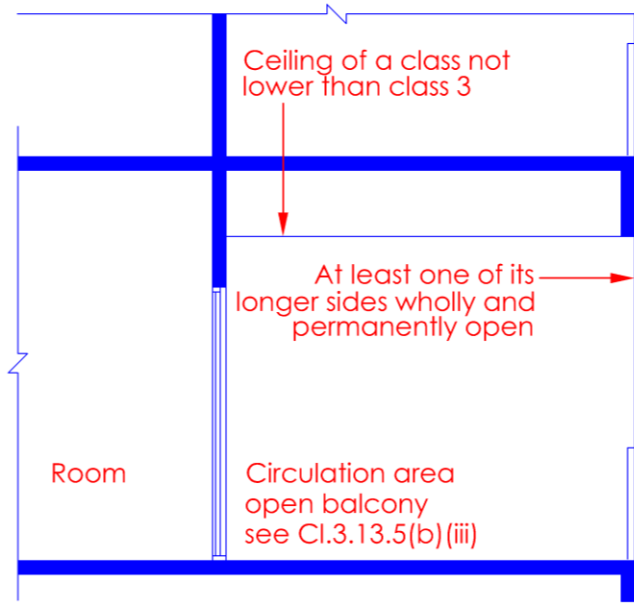

*Diagram 3.13.5(b)(ii)-1*

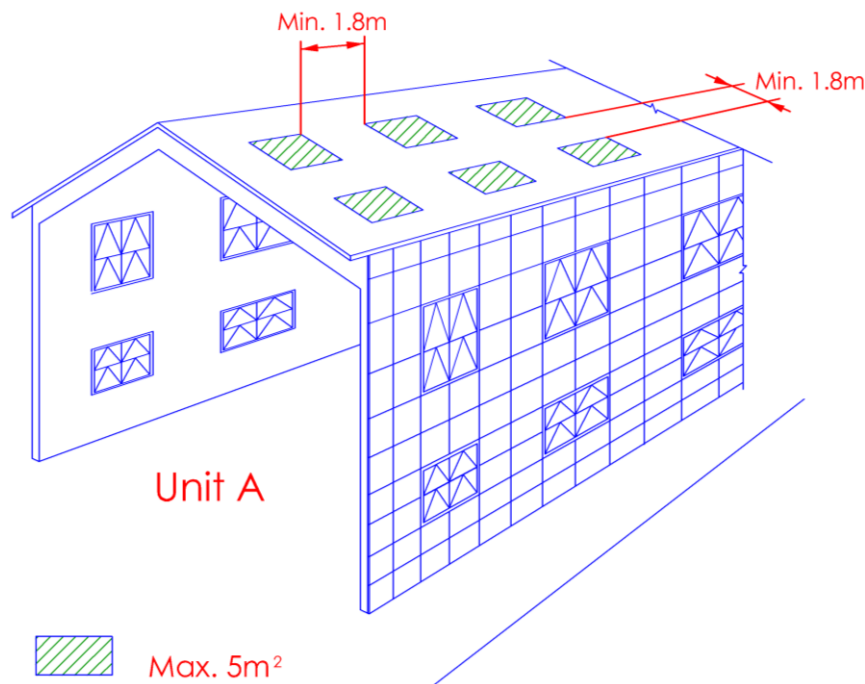

*Diagram 3.13.5(b)(ii)-2*

- *Factories and warehouses are usually provided with translucent roof sheets or sky light for natural lighting.*
- *Any part of ceiling which is combustible shall have an area not exceeding 5m<sup>2</sup> and a class not lower than Class 3 flame spread. It shall be separated from any such part by at least 1.8m*
- *The aggregate area of such part of ceiling shall not exceed 20% of the floor area*

Unenclosed loading/unloading platform

Diagram 3.13.5(b)(iii)-1

Covered linkway connecting 2 buildings

Diagram 3.13.5(b)(iii)-2

*In-addition to the above, ceilings to balcony, verandah, open carport are also allowed to have not lower than Class 3 flame spread. The above relaxation is allowed as the ceilings are located at the periphery of the building where smoke and heat could easily be dispersed into the exterior air*

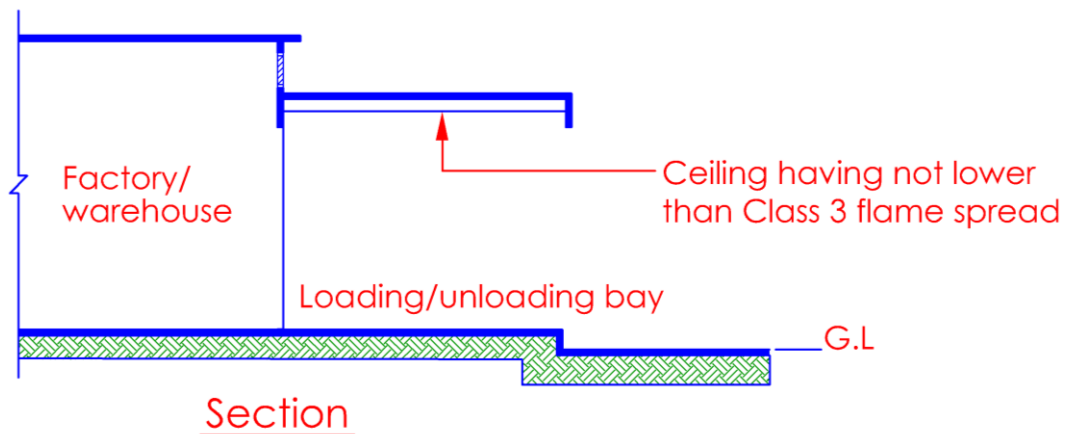
*Any material, including gypsum board or plaster board, which satisfies the requirements under clause 1.2.42 as non-combustible material is to be treated as acceptable under the above clause, regardless of the presence of the 0.5mm thick paper facing.*

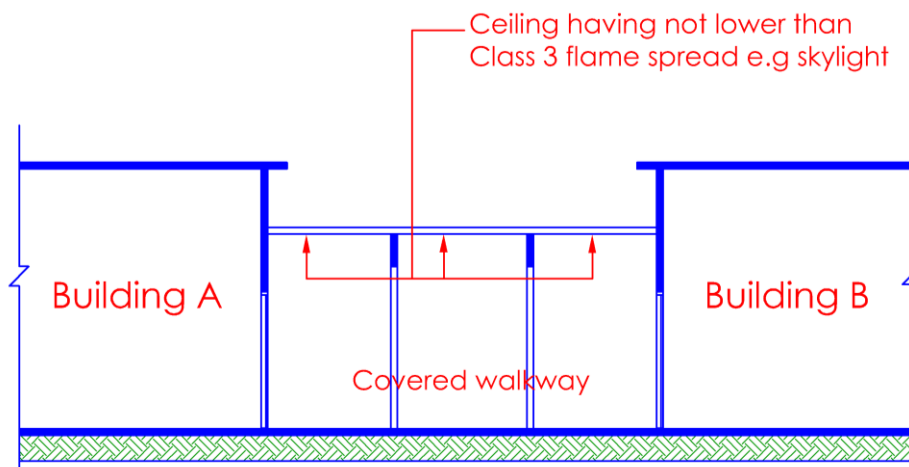
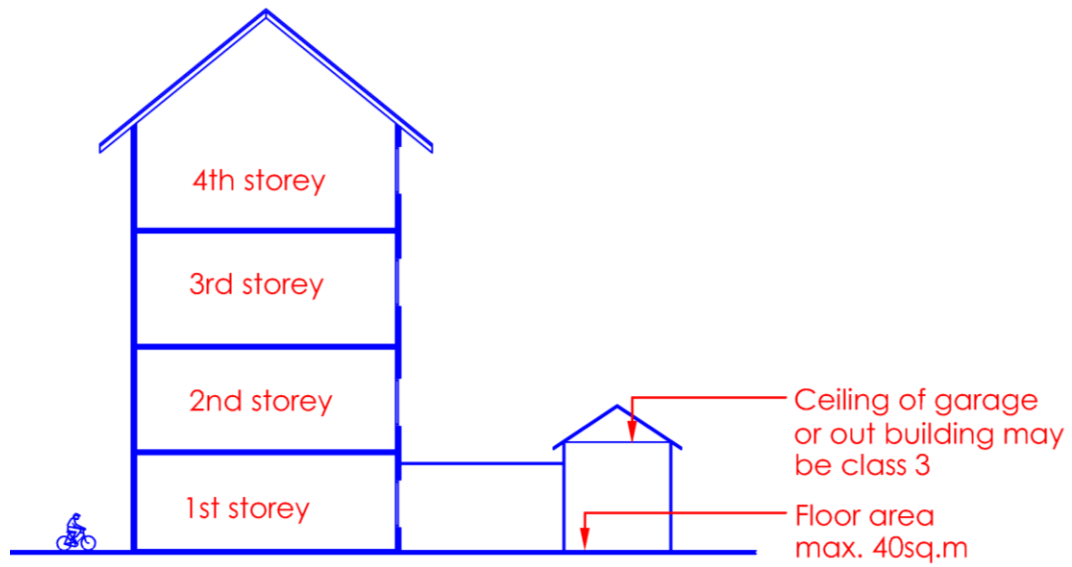

*Diagram 3.13.5(b)(iv)-1*

*Finishes to ceilings in circulation space in the building shall have a surface flame spread rating of not lower than Class 0 as required for under Table 3.13A*

*Finishes to ceiling of a room or compartment are permitted to have any class as permitted under Table 3.13A.*

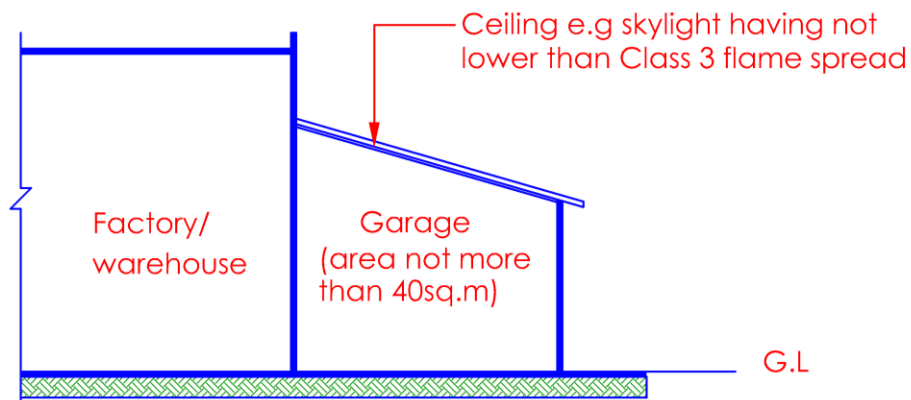

*Diagram 3.13.5(b)(iv)-2*

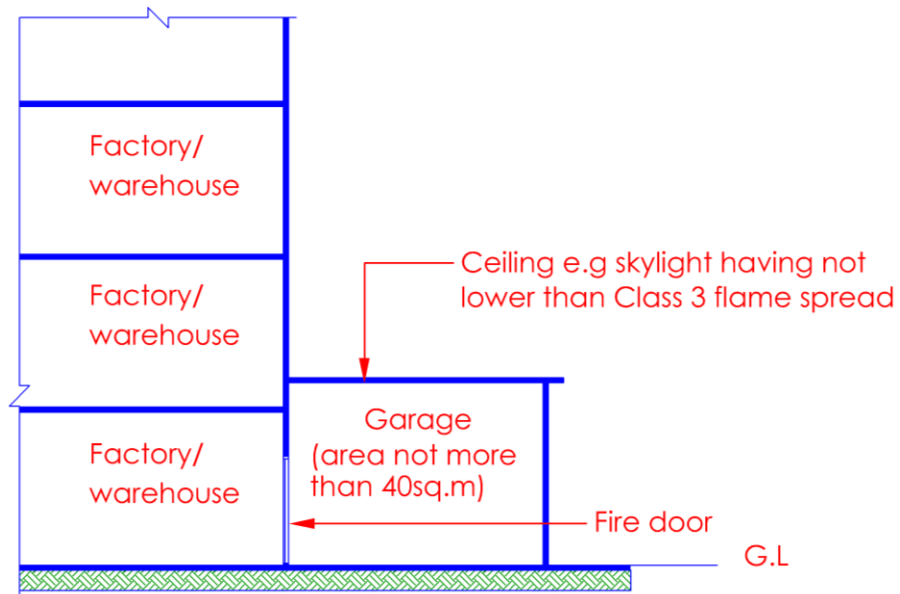

*Diagram 3.13.5(b)(iv)-3*

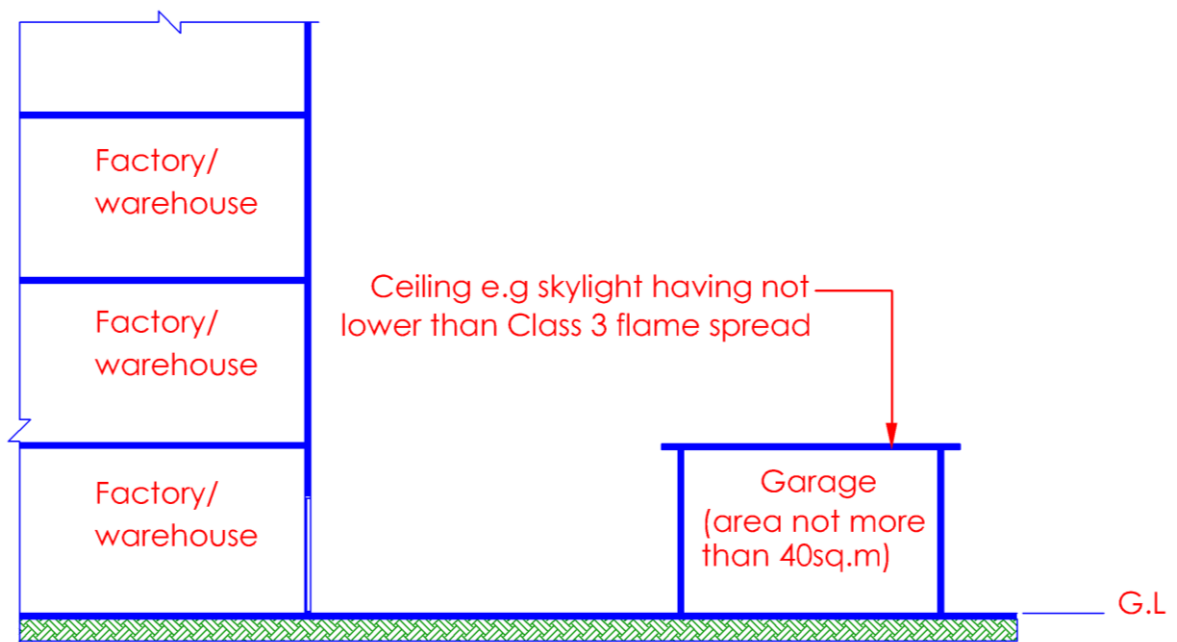

*Diagram 3.13.5(b)(iv)-4*

*A garage or outbuilding may have ceiling not lower than Class 3 flame spread, provided the gross floor area does not exceed 40m<sup>2</sup>*

# CHAPTER 3

## 3.13 RESTRICTION OF SPREAD OF FLAME OVER SURFACES OF WALLS AND CEILINGS

### 3.13.6 Exception

Wall and ceiling finishes in the form of thin sheet of not more than 1.0mm thickness mounted on a non-combustible substrate will not be subject to the requirement of surface spread of flame provisions provided that this exception shall not apply to smoke-stop/fire-fighting lobbies, exit staircases and passageways.

### EXPLANATIONS & ILLUSTRATIONS

*No illustration.*

*The above clause grants relaxation on the control of wall and ceiling finishes which are not more than 0.8mm thick mounted on non-combustible substrate, provided these finishes are not used in smoke-stop lobbies, exit staircases and exit passageways. The main concern is that all protected routes meant for escape of occupants shall be kept free of combustible finishes. The above finishes include material such as gypsum board.*

*Non-combustible boards, for example gypsum board, which meet the requirements of Cl.1.2.42 would be allowed to be used for the construction of smoke-stop lobbies, exit staircases and exit passageways.*

# CHAPTER 3

## 3.14 ROOF

### 3.14.1 Roof construction

Surface of materials for roof covering and roof construction shall have a surface spread of flame rating not lower than Class 1, or Class A when tested in accordance with ASTM E108, except in the case of Purpose Groups I and II, and in buildings that are protected throughout with automatic sprinkler system in compliance with Chapter 6.

### EXPLANATIONS & ILLUSTRATIONS

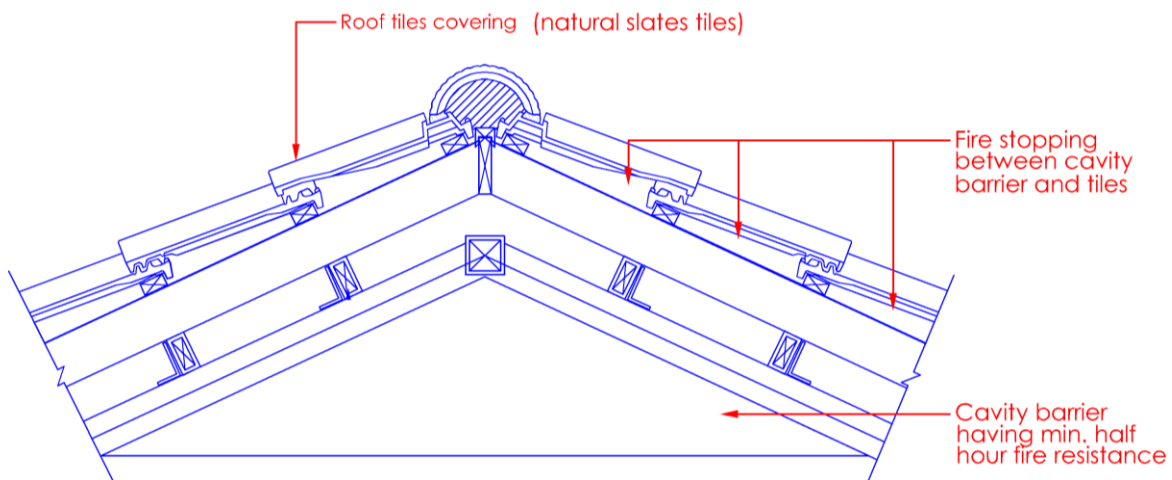

Diagram 3.14.1-1

*Roof construction to buildings under Purpose Group I usually use timber rafters and purlins for tiled roofs. Rooflights of combustible materials are usually used for lighting purposes. Generally, buildings under Purpose group I are small in area and low-rise. For semi-detached and terraced houses, the separating walls would be brought right-up to the underside of or above the roof coverings to prevent spread of fire.*

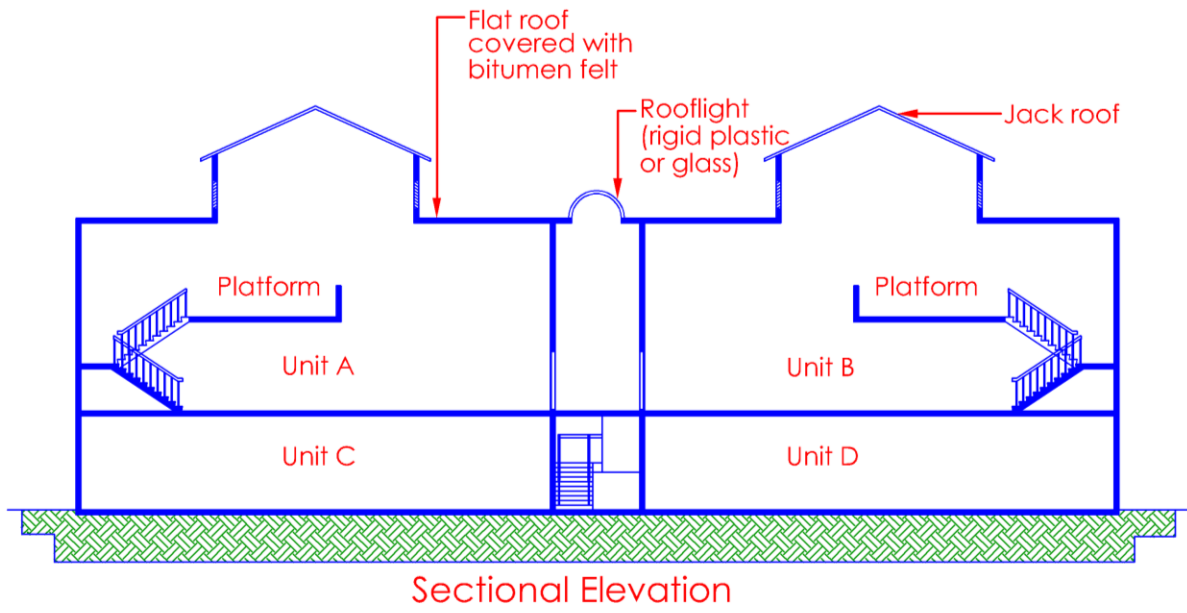

Diagram 3.14.1

Roofs of building under Purpose Group II may consist of dome, flat, pitched roof and other types. Roof covering may include mixture of combustible and non-combustible materials, e.g slate, clay tiles, glass, rigid plastic. It is quite common to find hardwood timber trusses, purlins etc being used in the roof construction. The term “roof covering” is used to describe construction which may consist of one or more layers of material, but does not refer to the roof structure as a whole. Roofs which may have different construction can be broadly grouped under the following:

- a) Roofs over common corridors and means of escape. As these areas are meant for escape, it would be preferable that they be constructed totally of non-combustible materials.
- b) Roof over apartment/maisonette or penthouse units.
- c) Roof over linkway between buildings.
- d) Roof used as terrace or floor open to sky. The roof covering should be of non-combustible materials to eliminate any fire risk arising from a fire involving the covering.
- e) Roof over balconies

Roof can also perform two functions:

- a) to contain a fire or prevent its penetration from an external source; and
- b) to ensure that the external covering does not contribute to spreading of fire so that an adjoining roof might be in danger.

RC roof would be able to satisfy the above functions. However, traditional roof coverings such as tile, slates, metal roofing sheets etc, combined with timber trusses/purlins and combustible insulation materials would have a greater tendency to allow spread of flame. Rigid plastic or thermo – plastic materials such as polycarbonate shall not be used. Similarly, thatched roof shall also not be used. Traditionally, tile roof construction requires timber battens and purlins for securing the tiles. However, the risk of fire spread via such timber members is taken care of by the provision of separating wall between residential units.

# CHAPTER 3

## 3.14 ROOF

### 3.14.2 Provision for buildings not exceeding four storeys

The Relevant Authority may consent to the use of combustibile material for roof construction for buildings of Purpose Groups III, IV, V and VII, which satisfy the following requirements:

- (a) Building does not exceed four storeys, and
- (b) Roof space between the roof and the ceiling shall be sub-divided by cavity barriers where required to comply with the relevant provisions of Cl.3.11, and openings in cavity barriers shall be fire-stopped to comply with the requirements of Cl.3.12, and

### EXPLANATIONS & ILLUSTRATIONS

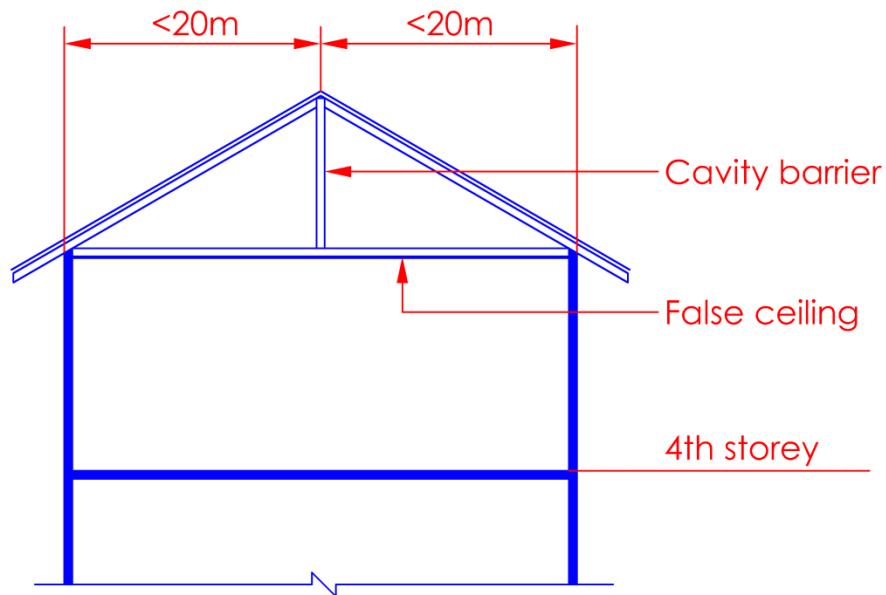

Diagram 3.14.2(b)

*The provision of cavity area barrier is to prevent the spread of fire in the roof spaces. Any service penetration to the cavity barrier shall be fire stopped.*

*The cavity barrier shall have minimum ½ hour fire resistance rating.*



- (c) If the underside of the roof serves as the ceiling to a room or space, the elements of the underside of the roof shall comply with the relevant provisions of Cl.3.13 for restriction of spread of flame.

**EXPLANATIONS & ILLUSTRATIONS**

**3.14.2(c)**

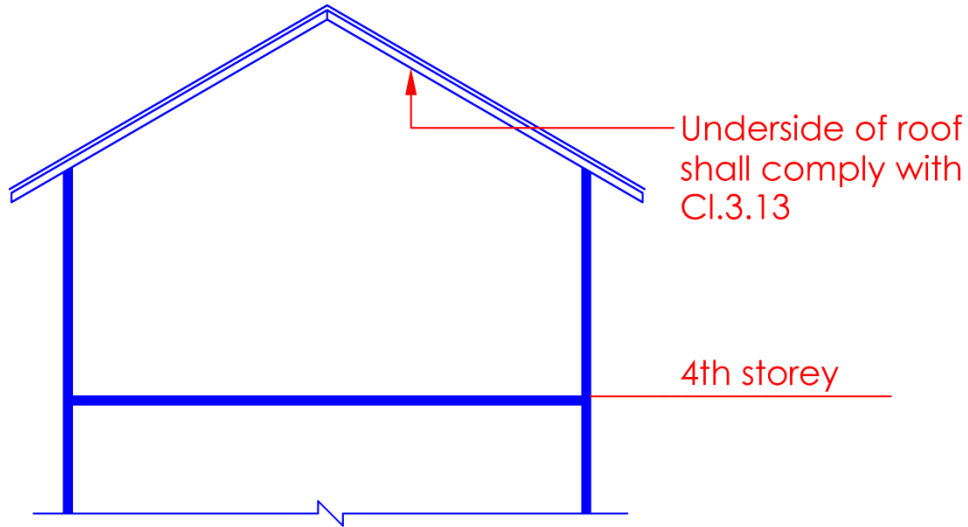

*Diagram 3.14.2(c)*

*Where false ceiling is not provided, the underside of the roof would be considered as the ceiling to the space below. Hence, there is a need to control the surface flame spread of the exposed underside of the roof construction.*

# CHAPTER 3

## 3.14 ROOF

### 3.14.3 Roof junction with separating wall and compartment wall

At the junctions with separating wall or compartment wall, roof construction shall comply with the relevant requirements under Cl.3.6.3 and Cl.3.7.4 respectively.

#### EXPLANATIONS & ILLUSTRATIONS

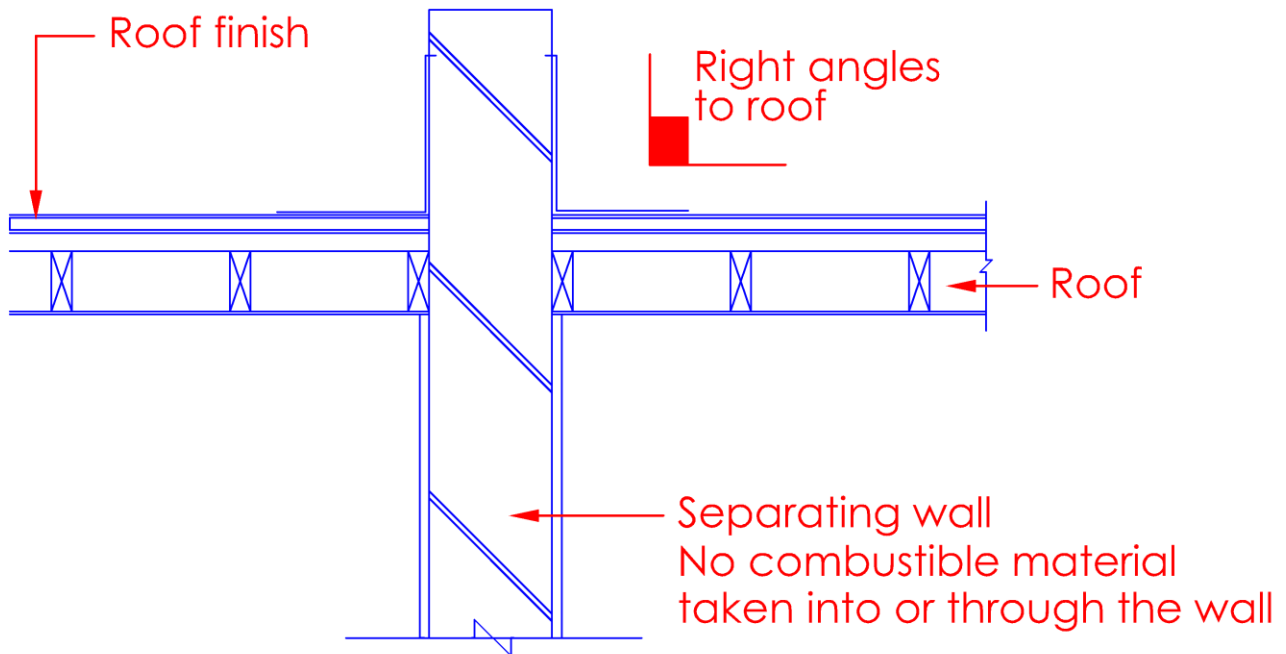

Diagram 3.14.3

# CHAPTER 3

## 3.14 ROOF

### 3.14.4 Roof terrace

Roof terrace shall not be roofed over. If it is either partially or fully roofed over, it shall be considered as a habitable floor.

#### EXPLANATIONS & ILLUSTRATIONS

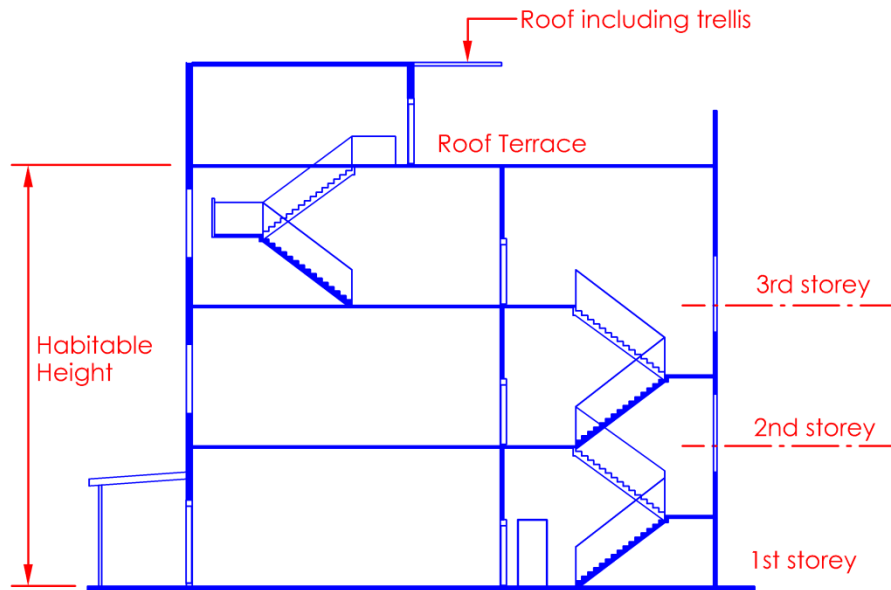

Diagram 3.14.4

#### Roof Terrace

##### a) Means of escape

Roof terrace even if not roofed over could be used by building owners to hold private functions. In this respect, the roof terrace would attract additional occupant load, which could be sizeable, depending on the type of function proposed, for example, a private dinner function could be held on the open roof terrace. The guests and the hosts that are attending the private function on the roof terrace would be subject to the risk of a fire that could break out in any of the floor space below the roof terrace. For this reason, roof terrace, whether roof over or not should be subjected to compliance with exit capacity and travel distance requirements under the fire code. Roof terrace which exceeds the floor area of 60sq. m shall be provided with a separate exit at terrace level.

##### b) Habitable height

For the purpose of determining the habitable height of a building, roof terrace that is either partially or fully roofed over shall be considered as a habitable floor. Thus, if the roof terrace is the highest habitable floor, the habitable height of a building shall be measured from the lowest level of the fire engine access road to the finished floor level of the highest habitable floor.

In the above diagram, the habitable height of the building shall be measured up to the finished floor level of the terrace. Otherwise it shall be measured up to the finished floor level of the 3<sup>rd</sup> storey.

# CHAPTER 3

## 3.15 MATERIALS FOR CONSTRUCTION

### 3.15.1

(a) Materials used in the construction of building elements shall comply with the provisions stated under this section in addition to the performance requirements such as for fire resistance and limit to spread of flame as stipulated in other relevant sections of the code.

(b) Intumescent Paints

Intumescent paints is allowed to be used for protection of structural steel members of all buildings provided :

- (i) the paint shall be of a proprietary system that has been demonstrated to achieve the fire resistance performance as required in BS 476 Part 20/21 or its equivalent, together with the specified weathering tests as specified in the BS 8202: Part 2;
- (ii) coating of intumescent paint onto structural steel, and subsequent maintenance shall conform to BS 8202: Part 2; and
- (iii) all requirements stipulated in the Appendix to this clause: “Notes on the use of Intumescent Paints for Protection to Structural Steel Members of Buildings” shall be complied with. (Please see Appendix (6))

Note: In buildings under Purpose Groups VI & VIII, where there may be presence of corrosive atmosphere that may affect the effectiveness of intumescent paints for protection to structural steel members of buildings, such proposal shall be subjected to evaluation of the Relevant Authority.

(c) Flame retardant chemicals are permitted to be used for upgrading of fire resistance rating or surface spread of flame of timber or any combustible materials, subject to the following:

- (i) The chemical treatment process is part and parcel of the manufacturing process to produce the finished product ;
- (ii) The chemical treatment is by means of pressure impregnation conforming to SS 572 – Use of Timber in Building Construction, or the manufacturer’s specification in accordance to the prototype test, for timber and other combustible materials respectively.
- (iii) The treated materials/products have been subjected to fire test as required under Cl.3.4.1 or Cl.3.13.1

*No illustration.*

1. *It is recognised as an alternative means to protecting timber construction in buildings.*
2. *However, we have to understand the limitations on the use of flame retardant chemicals for upgrading of fire resistance and/or surface spread of flame rating of combustible materials. The limitations are as follows:-*
  - a. *The chemicals may deteriorate after exposing to the environment for a long duration. After such, the fire resistance performance or the surface spread of flame rating may be adversely affected over time.*
  - b. *The inherent property of the flame-retardant chemical to resist fire spread may be affected when cleaning agent is constantly applied to the surface of the combustible material.*
  - c. *There is no specific method and control of treatment of the flame-retardant chemical. This would lead to poor performance as a result of shoddy construction of the materials.*
  - d. *There is no certainty on the duration for which the fire property in a material applied with such a chemical can last.*
3. *For buildings which are not under Conservation, the use of timber materials should be carefully considered and should be avoided where possible.*
4. *Building owners and occupiers should be made aware of the above mentioned limitations on the use of flame retardant chemicals. In the course of using the premises, building owners and occupiers shall not do anything to cause the retardant treatment to timber members to deteriorate.*

*The above sub-clause specifically prohibits the use of intumescent paints. In the construction of mezzanine floor where steel joists may be used, other form of fire protection to the steel members should be used, for example, sprayed-on protection. The main concern for not accepting intumescent paints for steel work protection is the durability of the material in our climatic conditions. The intumescent paints work well in climatic condition where the percentage of humidity does not exceed 75%.*

*For lining of walls and ceilings, and construction of mezzanine floor, flame retardant chemicals shall not be used to treat the timber members or other combustible materials to meet surface flame spread and fire resistance rating requirements respectively.*

*The main concerns for not accepting flame retardant chemicals are :*

- (i) *there is no guarantee of the permanency of the flame retardant chemicals in the wood or other combustible materials;*
- (ii) *the flame retardant chemicals are toxic elements, which when subjected to flaming would produce large quantities of toxic gases.*

# CHAPTER 3

## 3.15 MATERIALS FOR CONSTRUCTION

### 3.15.2

All elements of structure shall be constructed of non-combustible materials in addition to the relevant provisions as follows:

Cl.3.3 for fire resistance of elements of structure,  
Cl.3.5.1, 3.5.2 & 3.5.4 for External Walls,  
Cl.3.6.1(c)/(d) & 3.6.5 for Separating Walls,  
Cl.3.7.1(c)/(d), 3.7.5 & 3.7.6 for Compartment Walls and Compartment Floors,  
Cl.3.8.2(c), 3.8.4, 3.8.7(c), 3.8.8(b), 3.8.8(e) and 3.8.9(a) for Protected Shafts.

### EXPLANATIONS & ILLUSTRATIONS

*No illustration.*

# CHAPTER 3

## 3.15 MATERIALS FOR CONSTRUCTION

<b>3.15.3</b>	
---------------	--

Materials used for the protection of openings shall comply with the relevant provisions of Cl.3.9 of the code for protection of openings.

<b>EXPLANATIONS &amp; ILLUSTRATIONS</b>	
---	--

*No illustration.*

# CHAPTER 3

## 3.15 MATERIALS FOR CONSTRUCTION

<b>3.15.4</b>	
Exit staircases shall be constructed of non-combustible materials to comply with the provisions of Cl.3.10.1.	

<b>EXPLANATIONS &amp; ILLUSTRATIONS</b>	
---	--

*See Cl.3.10.1 to 3.10.4 for illustration and explanation*



# CHAPTER 3

## 3.15 MATERIALS FOR CONSTRUCTION

<b>3.15.5</b>	
---------------	--

Materials used for the construction of raised floors shall comply with the provisions of Cl.3.11.8(a) and Cl.3.11.8(e).

<b>EXPLANATIONS &amp; ILLUSTRATIONS</b>	
---	--

*No illustration.*

# CHAPTER 3

## 3.15 MATERIALS FOR CONSTRUCTION

<b>3.15.6</b>	
Materials used for construction of ceiling and its supports shall comply with Table 3.13B, except for supports that are required to comply with Cl.3.11.9 (b).	

<b>EXPLANATIONS &amp; ILLUSTRATIONS</b>	
---	--

*No illustration.*

# CHAPTER 3

## 3.15 MATERIALS FOR CONSTRUCTION

<b>3.15.7</b>	
Construction of ceilings and ceiling supports located within sprinkler protected building shall comply with the provision of C1.3.11.10 (b)	

<b>EXPLANATIONS &amp; ILLUSTRATIONS</b>	
---	--

*No illustration.*

# CHAPTER 3

## 3.15 MATERIALS FOR CONSTRUCTION

<b>3.15.8</b>	
Materials used for fire stopping shall comply with the relevant provisions of Cl.3.12.2 and 3.12.3.	

<b>EXPLANATIONS &amp; ILLUSTRATIONS</b>	
---	--

*No illustration.*

# CHAPTER 3

## 3.15 MATERIALS FOR CONSTRUCTION

### 3.15.9

Materials used on the surfaces of walls and ceilings are required to meet the requirements for restriction of spread of flame and to comply with the performance requirements as stipulated under Cl.3.13.

### EXPLANATIONS & ILLUSTRATIONS

*No illustration.*

# CHAPTER 3

## 3.15 MATERIALS FOR CONSTRUCTION

<b>3.15.10</b>	
Materials used for roof construction shall comply with the provisions of Cl.3.14.1 & 3.14.2.	
<b>EXPLANATIONS &amp; ILLUSTRATIONS</b>	

*No illustration.*

# CHAPTER 3

## 3.15 MATERIALS FOR CONSTRUCTION

### 3.15.11

Internal non-load bearing walls in buildings shall comply with Table 3.13B and the materials for surface finishes of internal non-load bearing walls shall not be treated as part of the wall and shall comply with the relevant provisions of Cl 3.13.

### EXPLANATIONS & ILLUSTRATIONS

*All the internal non-load bearing walls in the residential units shall be constructed of non-combustible materials. Materials for surface finishes of all the walls, non-loading bearing, separating and compartment walls shall comply with Cl 3.13.5 and Cl.3.13.6.*

# CHAPTER 3

## 3.15 MATERIALS FOR CONSTRUCTION

### 3.15.12

- (a) Composite panels which consist of plastic core shall not be used either for the construction of internal non-load bearing walls, ceilings, external walls or as cladding to external walls of all buildings unless prior approval has been obtained from the Relevant Authority.

### EXPLANATIONS & ILLUSTRATIONS

*No illustration.*

*Composite panels are used as external walls or cladding of external walls to buildings. Prior approval should be obtained before any composite panel is erected on site. The main concern is that composite panels when subjected fire would burn vigorously to produce thick, poisonous fumes.*



- (b) Composite panels which consist of plastic core shall not be used either for the construction of internal non-load bearing walls, ceilings, external walls or as cladding to external walls of all buildings unless prior approval has been obtained from the Relevant Authority.

## EXPLANATIONS & ILLUSTRATIONS

3.15.12(b)



Diagram 3.15.12 (b)

*Materials with surface flame spread rating of not lower than Class 3, including phenolic panels, are allowed to be used in the construction of partitions for toilet cubicles only.*

*The exposed surface area of not more than 60m<sup>2</sup> of the partitions within the toilet refers to the surface exposed to air, inside and outside, of the partitions.*

*The reasons for allowing materials with surface flame spread rating of not lower than Class 3, including phenolic panels, in the construction of toilet cubicles are:-*

- a. toilets are considered as wet areas;*
- b. the amount of combustible materials would be limited;*
- c. the toilets are subjected to low transient occupancy.*

*There are many types of composite panels, having different thickness and properties of combustible core. The main concern is the combustible core of the panels, which could readily ignite and help fire spread externally from floor to floor of a building.*

*QPs shall consult and obtain SCDF (FSSD)'s approval on the use of any composite panels in their building project before making submission of building plans.*

# CHAPTER 3

## 3.15 MATERIALS FOR CONSTRUCTION

### 3.15.13

Fire rated glass wall/door to compartment walls, compartment floors, smoke-stop lobby and fire-fighting lobby, and protected shafts not containing exit staircase and fire lift.

In buildings which are protected by an automatic sprinkler system, fire rated glass can be used for the construction of compartment walls, compartment floors, enclosures to smoke-stop lobby and fire-fighting lobby, and protected shafts not containing exit staircase and fire lift, subject to the following:

- (a) The walls and doors shall have the necessary fire resistance, including insulation, when subject to test under BS 476: Part 20-23; and
- (b) The walls and doors shall meet the Class A of the Impact Performance requirements when subject to test under BS 6206 or AS 2208.

### EXPLANATIONS & ILLUSTRATIONS

*No illustration.*

# CHAPTER 3

## 3.15 MATERIALS FOR CONSTRUCTION

<b>3.15.14</b>	
Walls, ceilings, roof covering and finishes shall not contain any plastic material.	

<b>EXPLANATIONS &amp; ILLUSTRATIONS</b>	
---	--

*No illustration.*

# CHAPTER 3

## 3.15 MATERIALS FOR CONSTRUCTION

### 3.15.15

For additions and alterations to existing buildings, non-combustible partitions shall be used for separation of areas undergoing A&A works from other occupied areas of the building.

### EXPLANATIONS & ILLUSTRATIONS

*No illustration.*

*To separate areas undergoing A/A works from other occupied spaces, non-combustible partition is permitted instead of fire rated construction. However, the non-combustible partition shall be brought to the underside of the floor slab to segregate both spaces. This will help to prevent spread of smoke and fire which may be originated from the A/A works.*